

Алматы (7273)495-231  
Ангарск (3955)60-70-56  
Архангельск (8182)63-90-72  
Астрахань (8512)99-46-04  
Барнаул (3852)73-04-60  
Белгород (4722)40-23-64  
Благовещенск (4162)22-76-07  
Брянск (4832)59-03-52  
Владивосток (423)249-28-31  
Владикавказ (8672)28-90-48  
Владимир (4922)49-43-18  
Волгоград (844)278-03-48  
Вологда (8172)26-41-59  
Воронеж (473)204-51-73  
Екатеринбург (343)384-55-89

Иваново (4932)77-34-06  
Ижевск (3412)26-03-58  
Иркутск (395)279-98-46  
Казань (843)206-01-48  
Калининград (4012)72-03-81  
Калуга (4842)92-23-67  
Кемерово (3842)65-04-62  
Киров (8332)68-02-04  
Коломна (4966)23-41-49  
Кострома (4942)77-07-48  
Краснодар (861)203-40-90  
Красноярск (391)204-63-61  
Курск (4712)77-13-04  
Курган (3522)50-90-47  
Липецк (4742)52-20-81

Магнитогорск (3519)55-03-13  
Москва (495)268-04-70  
Мурманск (8152)59-64-93  
Набережные Челны (8552)20-53-41  
Нижний Новгород (831)429-08-12  
Новокузнецк (3843)20-46-81  
Ноябрьск (3496)41-32-12  
Новосибирск (383)227-86-73  
Омск (3812)21-46-40  
Орел (4862)44-53-42  
Оренбург (3532)37-68-04  
Пенза (8412)22-31-16  
Петрозаводск (8142)55-98-37  
Псков (8112)59-10-37  
Пермь (342)205-81-47

Ростов-на-Дону (863)308-18-15  
Рязань (4912)46-61-64  
Самара (846)206-03-16  
Санкт-Петербург (812)309-46-40  
Саратов (845)249-38-78  
Севастополь (8692)22-31-93  
Саранск (8342)22-96-24  
Симферополь (3652)67-13-56  
Смоленск (4812)29-41-54  
Сочи (862)225-72-31  
Ставрополь (8652)20-65-13  
Сургут (3462)77-98-35  
Сыктывкар (8212)25-95-17  
Тамбов (4752)50-40-97  
Тверь (4822)63-31-35

Тольятти (8482)63-91-07  
Томск (3822)98-41-53  
Тула (4872)33-79-87  
Тюмень (3452)66-21-18  
Ульяновск (8422)24-23-59  
Улан-Удэ (3012)59-97-51  
Уфа (347)229-48-12  
Хабаровск (4212)92-98-04  
Чебоксары (8352)28-53-07  
Челябинск (351)202-03-61  
Череповец (8202)49-02-64  
Чита (3022)38-34-83  
Якутск (4112)23-90-97  
Ярославль (4852)69-52-93

Россия +7(495)268-04-70

Казахстан +7(7172)727-132

Киргизия +996(312)96-26-47

<https://timken.nt-rt.ru/> || [tek@nt-rt.ru](mailto:tek@nt-rt.ru)

# Timken Industrial Seal Catalog

High Performance Seals • Large Bore Assembled Seals • Bearing Isolators







**TIMKEN**

**Technical Manual**



## Introduction

At Timken, customers turn to us to for innovative solutions that solve their most critical issues. When they do, they benefit from more than a century of knowledge in managing friction and transmitting power for a variety of industries and applications. We've applied this technical know-how to offer OEMs, distributors and end-users a complete line of products and services – from bearings, maintenance tools and condition monitoring products to engineered surfaces, training programs, bearing and chock repair, and more.

Now, from the people that brought you Timken industrial seals for small bore applications comes the latest addition to our seal family – a complete line of high performance oil seals and bearing isolators for large bore applications. Like all of our products and services, our seals are backed by our leading technical support and a vast distribution network. Turn to Timken today for a full line of Timken industrial seals that help improve bearing, equipment and bottom-line performance.

## Oil Seal Selection

### Single Lip Seal:

All-purpose seal available in a wide range of sizes. Suitable for most sealing applications.

### Dual Lip Seal:

Used for difficult sealing problems or applications involving the separation of two fluids or exclusion of foreign materials.

### Single Lip Split

**Seal:** Engineered for ease of installation on large shafts. Does not require costly teardown to replace seal.

### Bonded Seal:

Best choice for applications with low performance requirements. Economically priced.

### Special Purpose

**Seal:** Designed for use in high speed applications with spherical and tapered roller bearings.

### Bearing Isolator:

Keeps bearings protected from contaminants in applications where long life and superior protection from debris are required.

### Protector Seal:

Used in highly contaminated operating environments to protect bearings on both rotating and stationary shafts. Uniquely designed using microcellular technology.

## Using This Catalog

The following pages contain the information you need to make accurate decisions about the seals best suited for your standard applications. Our technical manual includes:

- Organization by seal type, with special sections for single lip, dual lip and special purpose seals. These three sections include critical information for easy and accurate seal selection.
- General engineering information, including nomenclature, technical specifications, tolerance charts and more.
- Installation instructions, with diagrams, and troubleshooting tips for common problems.

## How to Order

Timken high performance industrial seals and bearing isolators for large bore applications are available through our trusted network of authorized distributors. Timken works closely with distributors to deliver unparalleled value and innovation to end users in a variety of industrial markets.

When ordering oil seals for standard or special applications, please provide as much information about the end user as possible, including:

- Customer name and address
- Part name and numbers shown on customer's drawing
- Intended use/application:
  - Quantity
  - Packaging requirements
  - Material requirements
- Functional test requirements
- Suggested design
- Fixed dimensions
- RPMs/FPMs
- Shaft type
- Housing type
- Eccentricity requirements
- Temperature requirements
- Medium to be sealed
- Type of bearing

Turn to Timken today for a full line of industrial seals that help improve bearing, equipment and bottom-line performance.

# Index for Technical Manual

<b>Technology Overview</b>	1
<b>Engineering Data</b>	2
<b>Installation Instructions for Timken Oil Seals &amp; Bearing Isolators</b>	6
<b>Seal &amp; Material Selection Guides</b>	9
<b>Oil Seal Isolator Configurations</b>	10
<b>Oil Seal Product Information</b>	11
<b>Bearing Isolator Configurations</b>	18
<b>Bearing Isolator Products Information</b>	20
<b>Glossary</b>	23
<b>Appendix A – Product Identification by Model Number</b>	25
<b>Appendix B – Obsolete Oil Seals (Model Number to Part Number Conversions)</b>	30
<b>Appendix C – Compound Compatibility Chart</b>	33
<b>Appendix D – Seal Damage Analysis</b>	39
<b>Appendix E – Surface Speed Chart</b>	43
<b>Appendix F – Application Data Sheet</b>	44
Split Pillow Block Application Sheet - SNL-SNH-Type Blocks	45
Split Pillow Block Application Sheet - SAF-Type Blocks	46

**Turn to Timken**

No one knows bearings, and how to protect them, better than Timken. Our complete line of high performance oil seals and bearing isolators are specifically engineered for long life and high performance in the toughest applications. Turn to us for longer bearing life, increased productivity and reduced maintenance costs.

**Oil Seals**

Creating the most advanced seals for heavy industrial markets requires quality materials. Timken industrial seals are manufactured using special elastomers that are engineered for high abrasion resistance, low wear and outstanding temperature and chemical resistance. In addition, we have materials and designs suited for a wide range of applications and our color-coded seals help you identify the seal to ensure you are using the right seal for the right application. Available in a variety of sizes, our seals include:



**Timken N Black**  
Peak Temp. = 250°F



**Timken ES Blue**  
Peak Temp. = 350°F

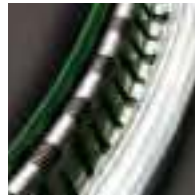

**Timken V Green**  
Peak Temp. = 450°F

**Technology**

As a technology leader in friction management solutions, we invest in our own research and development and partner with trusted suppliers to develop the highest quality materials for all of our products. Our new line of seals is no exception.

Product quality – and resulting uptime and performance – depend heavily on material selection. Remember, all radial lip seals are contact seals. The elastomer of the seal contacts the rotating element of the equipment and, over time, all elastomers will wear away. The difference in how competing seals perform is in the materials. Our oil seals are made with elastomers that are designed to minimize wear, improve seal life and increase uptime.

**Taber Abrasion Resistance**

The elastomers used to make Timken oil seals were developed with a special emphasis on abrasion resistance. In testing, our seals perform up to 90 percent better than seals made from traditional materials.

**Timken Nitrile (N) Black Industrial Seals**

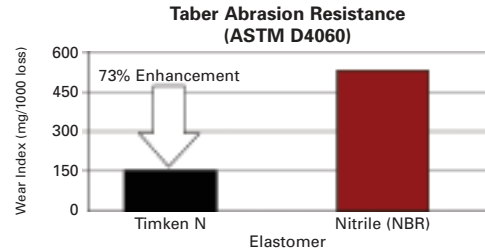

**Timken Hydrogenated Nitrile Butadiene Rubber (HNBR) Blue Industrial Seals**

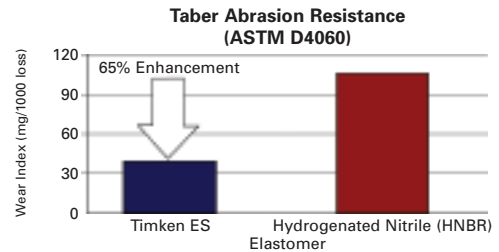

**Timken Fluoroelastomer (V) Green Industrial Seals**

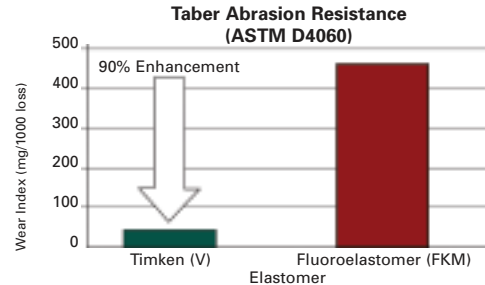

**Bearing Isolators**

Timken bearing isolators are an optimum choice when you require an extra layer of protection from contaminants in tough applications, such as pumps, motors, gearboxes and other rotating heavy equipment. Our metallic bearing isolators feature a cam lock design and engineered unitizing ring, providing heightened protection in a broad range of environments. Made from PTFE material, our non-metallic bearing isolators also offer superior protection.



### General Specifications

Timken industrial seals offer a leading combination of quality, technology and high performance. However, there are additional considerations – such as shaft finish, temperatures and other operating factors – that can help our seals achieve even higher levels of performance. We recommend the following practices to ensure that you are maximizing the efficiency and the life of your bearings and machinery. For specific application assistance, contact your Timken sales representative.

### Shaft Finish

The amount of contact between the shaft surface and the sealing element, and the condition of the shaft surface, has a significant impact on how well seals perform. Shafts containing “threads” or other texture are simply not able to be sealed effectively. Replacement oil seals always require new sealing surfaces.

Unless otherwise indicated, it is recommended that shaft finishes have a hardness of 30 to 40 Rockwell C. A minimum of 45 Rockwell C can provide extra protection from damage during handling or installation. See Table 1.

The most satisfactory method for shafts and sleeves is a plunge ground finish. We recommend 10-20  $\mu$  in. Ra (0.25-0.50  $\mu$ m) with no machine lead, scratches, dents, corrosion, pits or other surface defects.

**Table 1: Shaft Requirements**

Seal Type	Required Shaft Hardness Rockwell C	Required Shaft Finish	
		$\mu$ in (micro-inches) Ra	$\mu$ m (micrometers) Ra
Standard Oil Seals	30 - 40	10 - 20	0.25 - 0.50
PS-I Oil Seals	50 - 70	4 - 8	0.10 - 0.20
Bearing Isolators	Not Specified	64 maximum	1.63 maximum

**Table 2: Determination of Lead (Source: RMA Handbook OS-1/1985)**

Thread Movement During Clockwise (CW) Rotation	Thread Movement During Counter-Clockwise (CCW) Rotation	Lead Definition
From Fixed End Towards Free End	From Free End Towards Fixed End	Clockwise Lead (Right-Hand) See Figure 1 and Figure 2
From Free End Towards Fixed End	From Fixed End Towards Free End	Counter-Clockwise Lead (Left-Hand) See Figure 3 and Figure 4
No Movement	No Movement	No Measurable Lead
From Fixed End Towards Free End	From Fixed End Towards Free End	Shaft may be tapered. Remount shaft end-for-end. If direction reverses, shaft is tapered.
From Free End Towards Fixed End	From Free End Towards Fixed End	Shaft may be tapered. Remount shaft end-for-end. If direction reverses, shaft is tapered.
From Fixed End Towards Free End	From Fixed End Towards Free End	Shaft may not be level. Remount shaft end-for-end. If direction does not reverse, shaft is not level.
From Free End Towards Fixed End	From Free End Towards Fixed End	Shaft may not be level. Remount shaft end-for-end. If direction does not reverse, shaft is not level.
Away From Center	Away From Center	Crowned Shaft
Toward Center	Toward Center	Cusped Shaft

### Shaft Lead

Spiral grooves, or lead, may be generated on a shaft surface by the relative axial movement of the finishing tool (lathe, belt, grinding wheel, etc.) during the finishing operation. Lead on a shaft can negatively affect a radial lip seal, causing severe leakage and seal failure.

### Detecting Lead

It is nearly impossible to manufacture lead-free surfaces, but the thread method allows lead to be detected and quantified. To do so, use the following procedure:

1. Mount shaft or sleeve in holding chuck.
2. Use 5 to 10 cps viscosity silicone oil to lightly coat the shaft or sleeve.
3. Because the most accurate results are achieved when the setup is level, check to ensure that the shaft or sleeve is level with the assembly.
4. Find a length of 100 percent extra strong quilting thread (dia. of 0.009 in. or 0.23 mm) or unwaxed dental floss for next step.
5. Use the thread to drape over the surface of the shaft and attach one ounce (28 g) weight at a distance below the shaft. This will create a string-to-shaft contact arc of 220° to 240°.
6. Adjust machine's rotational speed to 60 RPM.
7. Measure the axial movement of the thread while the shaft or sleeve rotates for a period of 30 seconds.
8. Look for movement at both edges of the shaft by placing the thread there as well.
9. Reverse the direction of the shaft or sleeve rotation and repeat the test.
10. Refer to Table 2 to determine results.



**Comparing Shaft Lead – Lead Angle**

The lead of a shaft is compared with other shafts of differing diameters by calculating the lead angle. This is found by dividing the string advance (in inches) by the product of the shaft circumference (in inches), and the number of revolutions required to advance the string the measured amount.

$$\text{LEAD ANGLE} = \frac{\text{ARCTAN} \times \text{String Advance}}{(\text{Shaft circumference}) \times (\text{number of turns})}$$

For example, a string will advance 0.300" in 30 seconds on a 4.000" shaft rotating at 60 RPM. The lead angle equals  $0.0456^\circ = 2' 44.1"$ . A 2" shaft with the same advance (0.300" in 30 seconds at 60 RPM) has a lead angle of  $0.0912^\circ = 5' 28.3"$ .

For best seal performance, industry standards recommend that the lead angle of a shaft be  $0^\circ \pm 0.05^\circ (\pm 3')$ .

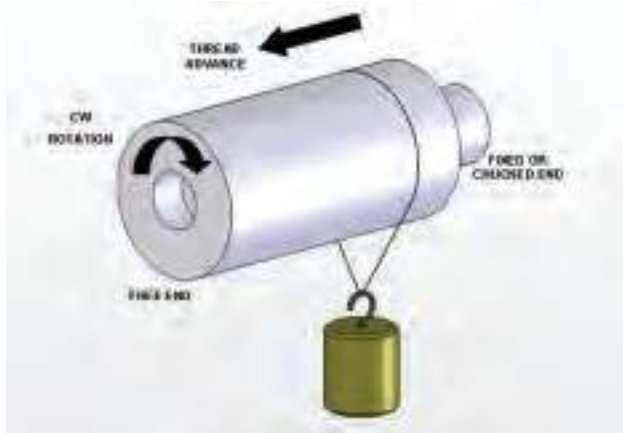

**Figure 1: Clockwise Lead**



**Figure 2: Clockwise Lead**

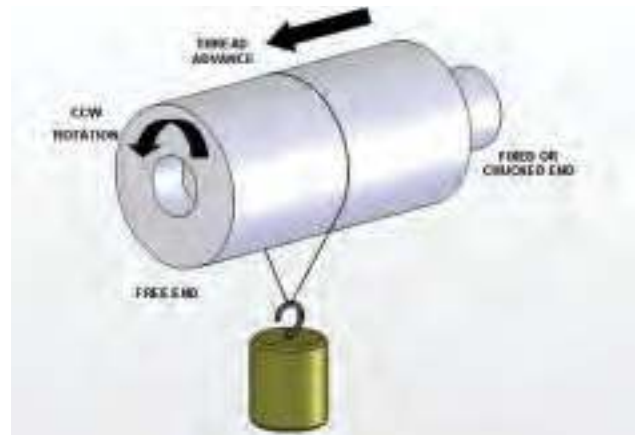

**Figure 3: Counter-Clockwise Lead**



**Figure 4: Counter-Clockwise Lead**

**Shaft-to-Bore Misalignment**

Shaft-to-bore misalignment is the distance by which a shaft is off center relative to its bore. To measure this, calculate the distance between the shaft centerline and the bore centerline, as shown in Figure 5.

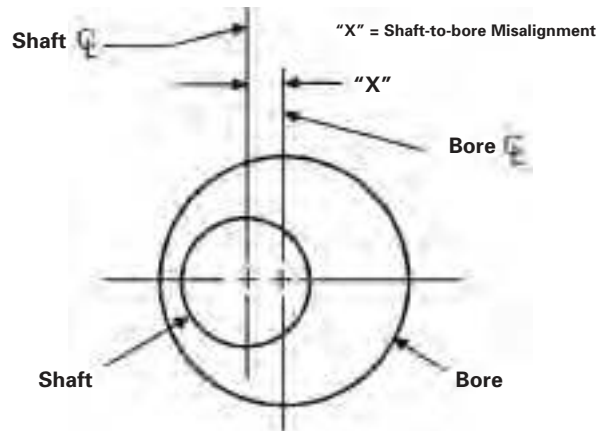
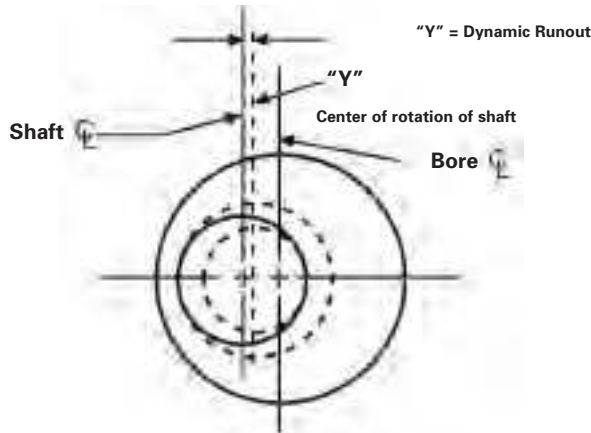

**Figure 5: Shaft-to-bore Misalignment**



**Dynamic Runout**

Dynamic runout is the amount by which a shaft, at the sealing surface, does not rotate around the true center. You can measure dynamic runout by holding a dial indicator against the shaft surface while it is slowly rotated. The resulting measurement is called a total indicator reading, or TIR. See Figure 6.



**Figure 6 — Dynamic Runout**

**Pressure Data**

Table 3 shows the maximum operating pressure suitable for standard oil seals, and Table 4 shows maximum pressure limits for a variety of sealing options. If an application generates higher surge pressures than what are listed, full details should be submitted for design consideration and engineering recommendations. Custom seals can be developed, although features such as ability to take greater eccentricities may be sacrificed to gain pressure capabilities. If possible, machine designs should include vents to allow the seal to operate more efficiently.

**Table 3: Operating Pressure Limits For Standard Oil Seals**

Shaft Speed		Maximum* Pressure		
f/m (feet per minute)	m/s (meters per second)	psi (pounds per sq.in)	kPa (kilopascals)	bar
0-100	0.0-5.1	7	48	0.50
1001-2000	5.2-10.2	5	35	0.35
2001 & up	10.3 & up	3	21	0.20

\* Split oil seals are not recommended for applications involving fluid pressure.

**Table 4: Maximum Pressure Limits**

Seal Type	Maximum Operating Pressure*		
	psi (pounds per sq.in)	kPa (kilopascals)	bar
Standard Oil Seals	7	48	0.50
PS-I Oil Seals	150†	1,034	10
Bearing Isolators	Ambient	Ambient	Ambient

\* Maximum operating pressure decreases as surface speed increases. Please consult your Timken sales representative for specific application operating pressures.

† Retaining plate required at pressures greater than 75psi.

**Shaft and Bore Tolerances**

Seal performance depends on close tolerances in the finished dimensions of the shaft, housing bore and oil seal. Tables 5, 6 and 7 give more information on proper tolerances.

**Table 5: Shaft Diameter Tolerances for Oil Seals**

Shaft Diameter		Recommended Tolerance	
inch	mm	inch	mm
Up thru 4.000	Up thru 101.60	±0.003	±0.08
4.001 - 6.000	101.61-152.40	±0.004	±0.10
6.001-10.000	152.41-254.00	±0.004	±0.13
10.001 & Up	254.01 & Up	±0.006	±0.15

The recommended bore diameter tolerances shown in Table 6 apply only to housings made from ferrous materials. For recommendations on seals made from non-ferrous materials, submit full details to your Timken sales representative.

Bore depth standard tolerance is +/- 0.016" (0.4 mm).

**Table 6: Housing Bore Tolerances for Oil Seals**

Housing Bore Diameter (Nominal)		Recommended Bore Diameter Tolerance	
inch	mm	inch	mm
Thru 1.000	Thru 25.40	±0.001	±0.03
1.001 - 3.000	25.41 - 76.20	±0.001	±0.03
3.001 - 4.000	76.21 - 101.60	±0.0015	±0.04
4.001 - 4.375	101.61 - 111.13	±0.0015	±0.04
4.376 - 6.000	111.14 - 152.40	±0.0015	±0.04
6.001 - 7.000	152.41 - 177.80	±0.002	±0.05
7.001 - 8.000	177.81 - 203.20	±0.002	±0.05
8.001 - 9.000	203.21 - 228.60	±0.002	±0.05
9.001 - 10.000	228.61 - 254.00	±0.002	±0.05
10.001 - 20.000	254.01 - 508.00	+0.002 -0.004	+0.05 -0.10
20.001 - 30.000	508.01 - 762.00	+0.002 -0.006	-0.15 +0.05
30.001 - 40.000	762.01 - 1016.00	+0.002 -0.006	-0.15 +0.05
40.001 - 60.000	1016.01 - 1524.00	+0.002 -0.010	-0.25 +0.05

Recommended Bore Finish = 100 microinches Ra (2.54 micrometers) or smoother.

**Table 7: Shaft and Bore Tolerances for Bearing Isolators**

Shaft Diameter		Recommended Tolerance	
inch	mm	inch	mm
Thru 6.000	Thru 152.40	±0.002	±0.05
6.001 & Up	152.41 & Up	±0.003	±0.08

Shaft Diameter		Recommended Tolerance	
inch	mm	inch	mm
Thru 6.000	Thru 152.40	±0.001	±0.03
6.001 - 10.000	152.41 - 254.00	±0.002	±0.05
10.001 & Up	254.01 & Up	±0.003	±0.08

**Surface Speed**

Shaft finish, misalignment and runout, lubrication, pressure and seal design are all factors in determining safe operating speeds, and become more important the more the shaft speed increases. To determine the appropriate surface speed for your application(s), use the formulas below or See Appendix F for the surface speed chart. Because surface speed limits vary with seal design, also refer to the product listings for limits on specific Timken industrial seals.

- Surface Speed (f/m) = Shaft Dia. (in) x RPM x 0.262
- Surface Speed (f/m) = Shaft Dia. (mm) x RPM x 0.0103
- Surface Speed (f/m) = Shaft Dia. (in) x RPM x 0.013299
- Surface Speed (m/s) = Shaft Dia. (m/s) x RPM x 0.0000524

**Conversion Formulas**

Conversion Formulas		
Multiply	By	To Obtain
Inch (in)	25.4	millimeter (mm)
millimeter (mm)	0.0394	Inch (in)
bar	100	kilopascal (kPa)
bar	14.504	psi (lb/sq. in)
kilopascal (kPa)	0.010	bar
kilopascal (kPa)	0.145	psi (lb/sq. in)
psi (lb/sq. in)	0.0689	bar
psi (lb/sq. in)	6.895	kilopascal (kPa)

Temperature Conversion Formulas	
	°F = 1.8 (°C) + 32
	°C = (°F - 32)/1.8

**NOTE**

Recommendations printed in this catalog pertaining to shaft finishes, misalignment, runout, speeds, temperatures and tolerances are generally applicable. The combination of a selected seal with a certain application, and the operating circumstances involved, could modify the performance of the seal and/or the equipment. To get the most out of your Timken seals, submit full information to ensure that the seal(s) you receive are suitable for your application.

**Equipment Inspection and Preparation**

Before installing any lip seal, equipment should be thoroughly inspected. Follow the specifications below for best results:

**Shaft Surface Finish [Roughness Average or AA (Arithmetic Average)]**

- With the exception of PS-1 (Model 61), all seals should have a surface finish within 10-20  $\mu$  in. (0.25-0.50  $\mu$ m).
- For PS-1 (Model 61), the surface finish should be within 4-8  $\mu$  in (0.10-0.20  $\mu$ m).
- The surface finish direction of all seals must be perpendicular to the shaft axis of rotation.

**Bore Surface Finish, Ra ([Roughness Average or AA (Arithmetic Average)]**

- The surface finish of all seals must be 100  $\mu$  in. (2.54  $\mu$ m).
- The surface finish direction of all seals must be perpendicular to the shaft axis of rotation.

**Shaft Surface Hardness, Rockwell C-Scale**

- With the exception of PS-1 (Model 61), all seals should have a surface hardness between 30-40 Rockwell C.
- For PS-1 (Model 61), the surface hardness must be within 50-70 Rockwell C.

**Additional Specifications**

- Both the shaft and bore should include an edge relief (preferably an edge chamfer), as shown in *Figures 7 and 8*. See *Tables 8 and 9* for specific values.

- Both the shaft and bore should be clear of any defects, such as spiral-machining marks, burrs, sharp edges, nicks, scratches and corrosion.
- Typically, the shaft has a wear groove created from previous seals. Make sure the new sealing lip does not seal in the same location.
- When drive features such as keyways or splines are present, they must be covered using an installation tool similar to the one shown in *Figure 9* below, and using "Installation Method D" shown in *Figure 10* on the next page. If the use of a tool is prohibited by the size of the shaft, use one of the following options:
  - Polyethylene tape
  - Brass shim stock with smooth edges
  - Wooden plug with smooth edges



**Figure 9: Seal Cross Section**

- Inspect the sealing lip for any signs of damage, such as cuts, indentations and nicks.
- Make sure that the spring (finger or garter type) is retained within the seal (bonded or assembled).
- Inspect the seal OD, looking for any signs of damage, such as cuts (in rubber seals), indentations and nicks.

**Installation Methods**



**Installation Method A Thru Bore:**  
Installation tool bottoms on machined face



**Installation Method B Thru Bore:**  
Seal bottoms on machined bore shoulder



**Installation Method C Thru Bore:**  
Installation tool bottoms on shaft



**Installation Method D Thru Bore:**  
Mounting thimble assists in compressing seal lip for easier installation

**Figure 10: Installation Methods**

**Solid Seal Installation**

Install the seal(s) using one of the proper installation methods shown in *Figure 10*. When using installation tooling, the diameter, or contact area, should not be more than 0.010" (0.254 mm) smaller than the bore diameter. If the use of an installation tool is prohibited by the size of the seal, then:

- Rest a block of wood (piece of 2" x 4" or similar) on the seal and use a mallet to drive the seal into position. Do not hit the seal directly with the mallet, as it may cause damage.
- When using this method, follow a star pattern (as shown in *Figure 11*) to avoid "cocking" of the seal.
- Place the ends of the wooden block at positions 1 and 2 (as shown in *Figure 11*).

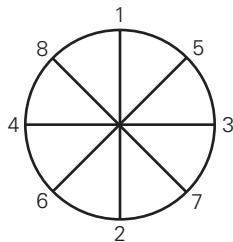

**Figure 11: Star Pattern**

- Hit the center of the board with the mallet.
- Continue by rotating the wooden block to the appropriate positions (3 and 4, 5 and 6, 7 and 8), hitting the center of the block with the mallet each time.
- Repeat the pattern until the seal is properly seated in the housing bore. The seal is fully seated when the difference between the seal surface and the housing surface is 0.010" (0.254 mm).

**Split Seal Installation**

Ambient pressure/ non-flooded applications only

- Apply a thin coat of lubricant to the seal lip and shaft.
- Split the seal along the axis of rotation (shown in *Figure 12*) and place the seal around the shaft.



**Figure 12: Split Seal Separation**

- Beginning with the split ends, insert the seal into the housing bore. Make sure the splits ends of the seal are touching.
- Working downwards on both sides, continue inserting the seal into the housing bore, finishing at the bottom.
- Once the seal is properly seated in the housing bore, it should protrude from the housing surface by 0.015" (0.381 mm), as shown in *Figure 13*. The 0.015" protrusion is built into the width of the seal. The depth of the bore housing should be machined to the seal width specified on the packaging.

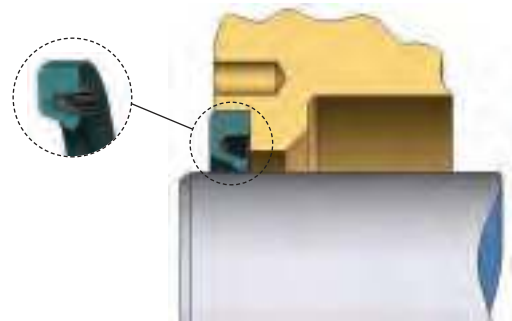

**Figure 13: Split Seal Installed**

**Inspection**

After installation, inspect the sealing areas for leaks, paying special attention to the area around the sealing lip and the OD. Make sure that the sealing lip is not in the groove worn into the shaft from the previous seal.



**Equipment Preparation**

Before installing an isolator, all equipment should be inspected. First, disconnect all power to the machinery and follow standard safety procedures to avoid personal injury or equipment damage during installation.

Second, inspect the shaft and bore surfaces. The shaft finish should be better than  $64 \mu\text{in}$  ( $1.63 \mu\text{m}$ ) with minimal lead, but a polished surface is not required. The bore surface should be  $64 \mu\text{in}$  ( $2.54 \mu\text{m}$ ). Both the shaft and bore should have a chamfer or other edge relief to prevent the o-ring from shearing.

Third, check the shaft and bore for damage or imperfections. They should both be clear of burrs, nicks, indentations and any other defects. Clean all foreign debris from the area. Note that, in many cases, the previous seal may have worn a groove into the shaft. Make sure that the rotor o-ring of the new seal does not ride in this area.

Finally, if drive features such as keyways or splines are present on the shaft, they must be covered during installation. To do so, use an installation tool, polyethylene tape, brass shim stock with smooth edges or a wooden plug with smooth edges.

**Seal Preparation**

Timken metallic and non-metallic bearing isolators are unitized, and any attempts to take them apart will not only cause seal damage, but will void the warranty on the product.

Before installation, inspect the o-ring's OD and ID, making sure they are free of any defects. Use the lubricant included with your isolator to lightly grease all the o-rings.

**Installation**

Using your hands only (no installation tool required) push the isolator evenly onto the shaft *as shown in Figure 14*.



**Figure 14: Seal Installation on Shaft**

If your isolator has a drain port, rotate it to the 6 o'clock position. For isolators with an orientation slot on the OD of the stator, rotate it to the 12 o'clock position to ensure appropriate positioning of the drain port. Some non-metallic bearing isolators may be installed in any direction, and there is no need to position the seal. *See Figure 15* for clarification, or contact your Timken sales representative if you require additional information.



**Figure 15: Drain Port Positioning**

Using your hands only (no installation tool required), push the isolator gently into the bore. If required, gently tap the isolator using a mallet. While flanged isolators are fully seated when the flange is flush against the housing, flangeless isolators can be installed at the bottom of the housing and are fully seated when they are flush with the bore face. *See Figure 16* for clarification.



**Figure 16: Flanged Seal Flush with Housing Face**

**Post-Installation****Inspection**

After installation, inspect the sealing area for damage. Gently spin the shaft to make sure the rotor is working properly.

Do not flood the isolator or block the expulsion ports, as these actions can cause seal damage and failure.

**Removal**

To remove an old isolator from your equipment, start from the back side of the seal and perform installation instructions in reverse. If access to the back side of the isolator is difficult, pry it from the housing a little at a time. Be careful not to damage the shaft or housing bore during seal removal.

## Seal & Material Selection

### Seal Selection Guide\*

Seal Type	0-3 inches	3-6 inches	6-12 inches	Over 12 inches	Rotary	Reciprocating	0-1000	1000-2000	2000-3000	3000-5000	5000-7000	7000-12000	0.010	0.015	0.020	0.030	0.100	0.125	Ambient	7 psi	150 psi	25%	50%	100%	Timken N	Timken ES	Timken V	Silicone	GYLON	Bronze	Stainless Steel	PTFE	
Model 57	X	X	X		X		X						X						X	X		X	X	X	X	X	X						
Model 58	X	X	X		X		X						X						X	X		X	X	X	X	X	X						
Model 63	X				X		X	X	X				X	X					X	X		X	X	X	X	X	X	X					
Model 53		X	X	X	X		X	X	X				X	X					X	X		X	X	X	X	X	X	X					
Model 23		X	X	X	X		X	X					X						X			X	X										
Model 26 (solid)	X	X	X	X	X	X	X	X	X	X			X	X					X	X		X	X	X	X	X	X	X					
Model 26 (split)	X	X	X	X	X		X	X	X	X			X	X					X			X	X			X	X	X					
Model 59			X	X	X	X	X	X	X	X			X	X	X	X			X	X		X	X			X	X	X					
Model 87			X	X	X	X	X	X	X	X			X	X	X	X	X		X	X		X	X			X	X	X					
Model 64			X	X	X		X	X	X	X	X		X	X	X	X	X	X	X	X		X	X			X	X	X					
Model 145 <sup>°</sup>			X	X	X		X	X	X				X	X	X	X	X	X	X				N/A	N/A	N/A		X	X					
Model 143 <sup>°</sup>			X	X	X		X	X	X				X	X	X	X	X	X	X				N/A	N/A	N/A		X	X					
P/S <sup>°</sup> (Model 61)	X	X	X		X	X	X	X					Under 0.005						X	X	X	X	X	X						X			
GUARDIAN <sup>™†</sup>	X	X	X	X	X		X	X	X	X			X	X					X			X											X
MICRO-TEC <sup>6†</sup>	X	X	X	X	X		X	X	X	X			X	X	X				X			X											X
ISO-GARD <sup>6°</sup>	X	X	X	X	X		X	X	X	X	X	X	X	X	X				X			X									X	X	
EQUALIZER <sup>6°</sup>	X	X	X	X	X		X	X	X	X	X	X	X	X	X				X			X								X	X		
Parameter	Shaft Size			Type of Motion	Speed (FPM)				Max Radial Misalignment (inches)				Max Pressure		Media Level		Seal Material**																

\* Values shown are generally applicable limits. For specific application help, contact your Timken sales representative.

\*\* Seal materials shown are typical for oil seals. Other materials are available upon request. Contact your Timken sales representative for more information.

# Models 145 and 143 face seals are not available in Timken N, but are supplied with standard nitrile material.

† All Timken metallic bearing isolators are supplied with fluoroelastomer o-rings.

° All Timken non-metallic bearing isolators are supplied with fluoroelastomer o-rings.









### Material Selection Guide\*

Material Type <sup>†</sup>	Color	Durometer	Coefficient of Friction	Operating Temperature	Max Spike Temperature	Abrasion Resistance	Chemical Resistance	Comparative Cost
Timken N	Black	80	1.788	-40°F to 200°F (-40°C to 93°C)	250°F (123°C)	Moderate	Moderate	Low
Timken ES	Dark Blue	88	1.053	-40°F to 300°F (-40°C to 148°C)	350°F (177°C)	High	Improved	Moderate
Timken V	Green	76	1.158	-22°F to 400°F (-30°C to 204°C)	450°F (232°C)	High	Very Good	High
Silicone	Light Blue (FDA - Red)	N/A	Over 2.000	-75°F to 350°F (-59°C to 176°C)	400°F (232°C)	High	Excellent	High
Gylon <sup>°</sup>	Black	N/A	0.100	-120°F to 400°F (-84°C to 204°C)	450°F (232°C)	High	Excellent	High

\* Values shown are generally applicable limits. For specific application help, contact your Timken sales representative.

\*\* Seal materials shown are typical for oil seals. Other materials are available upon request. Contact your Timken sales representative for more information.

<b>Model 3</b> 	<b>Model 21</b> 	<b>Model 23</b> 	<b>Model 24</b> 	<b>Model 25</b> 	<b>Model 26</b> 	<b>Model 26-E</b> 	<b>Model 26-R1</b> 
<b>Model 53</b> 	<b>Model 53-F1</b> 	<b>Model 53-G1</b> 	<b>Model 53-R1</b> 	<b>Model 53-R2</b> 	<b>Model 53-T2</b> 	<b>Model 53-TB</b> 	<b>Model 53-TF</b> 
<b>Model 54</b> 	<b>Model 57</b> 	<b>Model 58</b> 	<b>Model 59</b> 	<b>Model 59-G1</b> 	<b>PS<sup>®</sup>-1</b> 	<b>PS<sup>®</sup>-1 Dbl Opposed</b> 	<b>PS<sup>®</sup>-1 Dbl Tandem</b> 
<b>PS<sup>®</sup>-1 Reverse Lip</b> 	<b>Model 62</b> 	<b>Model 63</b> 	<b>Model 63-F1</b> 	<b>Model 63-G1</b> 	<b>Model 63-R1</b> 	<b>Model 63-R2</b> 	<b>Model 63-T2</b> 
<b>Model 63-TB</b> 	<b>Model 63-TF</b> 	<b>Model 64</b> 	<b>Model 64-G1</b> 	<b>Model 71</b> 	<b>Model 76</b> 	<b>Model 87</b> 	<b>Model 88</b> 
<b>Model 91</b> 	<b>Model 92</b> 	<b>Model 94</b> 	<b>Model 111</b> 	<b>Model 113</b> 	<b>Model 123</b> 	<b>Model 143</b> 	<b>Model 145</b> 

Large Seals	Features	Materials	Temperature	Shaft Diameter in. (mm)	Surface Speed	Spring Type	Misalign. in. @ f/m (mm@m/s)	Pressure
 <b>Model 26</b>	<ul style="list-style-type: none"> <li>• General purpose seal</li> <li>• Solid or split design</li> <li>• Reverse bevel lip design prevents lip rollover</li> <li>• Reinforced rubber O.D.</li> <li>• Single and dual lip configurations available</li> </ul>	<ul style="list-style-type: none"> <li>• Timken N</li> <li>• Timken ES</li> <li>• Timken V</li> </ul>	<ul style="list-style-type: none"> <li>• -40°F (-40°C) to 200°F (93°C)</li> <li>• -40°F (-40°C) to 300°F (150°C)</li> <li>• -22°F (-30°C) to 400°F (204°C)</li> </ul>	<ul style="list-style-type: none"> <li>• 0.750 to 60.000</li> <li>• (19.0 to 1524.0)</li> </ul>	5,000 f/m (25.4 m/s)	Molded-in stainless steel finger	<ul style="list-style-type: none"> <li>• 0.015 @ 1,000 (0.38 @ 5.10)</li> <li>• 0.010 @ 2,000 (0.25 @ 10.20)</li> <li>• 0.008 @ 5,000 (0.20 @ 25.40)</li> </ul>	To 7 psi (0.4 bar) (N/A if split)
 <b>Model 26R1</b>	<ul style="list-style-type: none"> <li>• General purpose dual lip seal</li> <li>• Low-speed service</li> <li>• Reverse bevel lip design prevents lip rollover</li> </ul>	<ul style="list-style-type: none"> <li>• Timken N</li> <li>• Timken ES</li> <li>• Timken V</li> </ul>	<ul style="list-style-type: none"> <li>• -40°F (-40°C) to 200°F (93°C)</li> <li>• -40°F (-40°C) to 300°F (150°C)</li> <li>• -22°F (-30°C) to 400°F (204°C)</li> </ul>	<ul style="list-style-type: none"> <li>• 0.750 to 60.000</li> <li>• (19.0 to 1524.0)</li> </ul>	5,000 f/m (25.4 m/s)	Molded-in stainless steel finger	<ul style="list-style-type: none"> <li>• 0.015 @ 1,000 (0.38 @ 5.10)</li> <li>• 0.010 @ 2,000 (0.25 @ 10.20)</li> <li>• 0.008 @ 5,000 (0.20 @ 25.40)</li> </ul>	To 7 psi (0.4 bar) (N/A if split)
 <b>Model 59</b>	<ul style="list-style-type: none"> <li>• Severe service assembled seal</li> <li>• Heavy duty outer case</li> <li>• Reverse bevel lip design prevents lip rollover</li> <li>• Aggressive shaft-to-bore misalignment capability</li> </ul>	<ul style="list-style-type: none"> <li>• Timken N</li> <li>• Timken ES</li> <li>• Timken V</li> </ul>	<ul style="list-style-type: none"> <li>• -40°F (-40°C) to 200°F (93°C)</li> <li>• -40°F (-40°C) to 300°F (150°C)</li> <li>• -22°F (-30°C) to 400°F (204°C)</li> </ul>	<ul style="list-style-type: none"> <li>• 6.000 to 90.000</li> <li>• (152.4 to 2286.0)</li> </ul>	5,000 f/m (25.4 m/s)	Molded-in stainless steel finger	<ul style="list-style-type: none"> <li>• 0.015 @ 1,000 (0.38 @ 5.10)</li> <li>• 0.010 @ 2,000 (0.25 @ 10.20)</li> <li>• 0.008 @ 5,000 (0.20 @ 25.40)</li> </ul>	To 7 psi (0.4 bar) (N/A if split)
 <b>Model 59G1</b>	<ul style="list-style-type: none"> <li>• Severe service dual lip assembled seal</li> <li>• GYLON® excluder lip for non-lubricated external conditions or corrosive external conditions</li> </ul>	<ul style="list-style-type: none"> <li>• Timken N</li> <li>• Timken ES</li> <li>• Timken V</li> </ul>	<ul style="list-style-type: none"> <li>• -40°F (-40°C) to 200°F (93°C)</li> <li>• -40°F (-40°C) to 300°F (150°C)</li> <li>• -22°F (-30°C) to 400°F (204°C)</li> </ul>	<ul style="list-style-type: none"> <li>• 6.000 to 40.000</li> <li>• (152.4 to 1016.0)</li> </ul>	2,500 f/m (12.8 m/s)	Molded-in stainless steel finger	<ul style="list-style-type: none"> <li>• 0.015 @ 1,000 (0.38 @ 5.10)</li> <li>• 0.010 @ 2,000 (0.25 @ 10.20)</li> <li>• 0.008 @ 5,000 (0.20 @ 25.40)</li> </ul>	To 7 psi (0.4 bar) (N/A if split)
 <b>Model 64®</b>	<ul style="list-style-type: none"> <li>• Severe service assembled seal</li> <li>• Heavy duty metal outer case</li> <li>• Unique carrier/garter spring combination</li> <li>• Industry's highest shaft-to-bore misalignment capability</li> </ul>	<ul style="list-style-type: none"> <li>• Timken N</li> <li>• Timken ES</li> <li>• Timken V</li> </ul>	<ul style="list-style-type: none"> <li>• -40°F (-40°C) to 200°F (93°C)</li> <li>• -40°F (-40°C) to 300°F (150°C)</li> <li>• -22°F (-30°C) to 400°F (204°C)</li> </ul>	<ul style="list-style-type: none"> <li>• 8.000 to 90.000</li> <li>• (203.2 to 2286.0)</li> </ul>	7,000 f/m (35.6 m/s)	Combination of stainless steel garter & stainless steel finger	<ul style="list-style-type: none"> <li>• 0.015 @ 1,000 (0.38 @ 5.10)</li> <li>• 0.010 @ 2,000 (0.25 @ 10.20)</li> <li>• 0.008 @ 5,000 (0.20 @ 25.40)</li> </ul>	To 7 psi (0.4 bar) (N/A if split)
 <b>Model 64G1</b>	<ul style="list-style-type: none"> <li>• Severe service dual lip assembled seal</li> <li>• GYLON® excluder lip for non-lubricated external conditions or corrosive external conditions</li> </ul>	<ul style="list-style-type: none"> <li>• Timken N</li> <li>• Timken ES</li> <li>• Timken V</li> </ul>	<ul style="list-style-type: none"> <li>• -40°F (-40°C) to 200°F (93°C)</li> <li>• -40°F (-40°C) to 300°F (150°C)</li> <li>• -22°F (-30°C) to 400°F (204°C)</li> </ul>	<ul style="list-style-type: none"> <li>• 8.000 to 55.000</li> <li>• (203.2 to 1397.0)</li> </ul>	3,500 f/m (17.9 m/s)	Carrier/garter combination	<ul style="list-style-type: none"> <li>• 0.015 @ 1,000 (0.38 @ 5.10)</li> <li>• 0.010 @ 2,000 (0.25 @ 10.20)</li> <li>• 0.008 @ 5,000 (0.20 @ 25.40)</li> </ul>	To 7 psi (0.4 bar) (N/A if split)
 <b>Model 87</b>	<ul style="list-style-type: none"> <li>• Severe service seal</li> <li>• Metal reinforced rubber O.D.</li> <li>• Reverse bevel lip design prevents lip rollover</li> <li>• Aggressive shaft-to-bore misalignment capability</li> </ul>	<ul style="list-style-type: none"> <li>• Timken N</li> <li>• Timken ES</li> <li>• Timken V</li> </ul>	<ul style="list-style-type: none"> <li>• -40°F (-40°C) to 200°F (93°C)</li> <li>• -40°F (-40°C) to 300°F (150°C)</li> <li>• -22°F (-30°C) to 400°F (204°C)</li> </ul>	<ul style="list-style-type: none"> <li>• 6.000 to 48.000</li> <li>• (152.4 to 1219.2)</li> </ul>	5,000 f/m (25.4 m/s)	Molded-in carbon steel garter	<ul style="list-style-type: none"> <li>• 0.015 @ 1,000 (0.38 @ 5.10)</li> <li>• 0.010 @ 2,000 (0.25 @ 10.20)</li> <li>• 0.008 @ 5,000 (0.20 @ 25.40)</li> </ul>	To 7 psi (0.4 bar) (N/A if split)
 <b>Model 88</b>	<ul style="list-style-type: none"> <li>• Severe service seal</li> <li>• Aggressive shaft-to-bore misalignment capability</li> <li>• Metal reinforced rubber OD for positive bore retention</li> </ul>	<ul style="list-style-type: none"> <li>• Timken N</li> <li>• Timken ES</li> <li>• Timken V</li> </ul>	<ul style="list-style-type: none"> <li>• -40°F (-40°C) to 200°F (93°C)</li> <li>• -40°F (-40°C) to 300°F (150°C)</li> <li>• -22°F (-30°C) to 400°F (204°C)</li> </ul>	<ul style="list-style-type: none"> <li>• 6.000 to 48.000</li> <li>• (152.4 to 1219.2)</li> </ul>	3,000 f/m (15.2 m/s)	Molded-in carbon steel garter	<ul style="list-style-type: none"> <li>• 0.015 @ 1,000 (0.38 @ 5.10)</li> <li>• 0.010 @ 2,000 (0.25 @ 10.20)</li> <li>• 0.008 @ 5,000 (0.20 @ 25.40)</li> </ul>	To 7 psi (0.4 bar) (N/A if split)

\* Most designs available without spring.







\* Most designs available in silicone and other materials.











Small Seals	Features	Materials	Temperature	Shaft Diameter in. (mm)	Surface Speed	Spring Type	Misalign. in. @ f/m (mm@m/s)	Pressure
 <b>Model 53</b>	<ul style="list-style-type: none"> <li>General purpose assembled seal</li> <li>Heavy-duty metal outer case</li> <li>Single and dual lip configurations available</li> </ul>	<ul style="list-style-type: none"> <li>Timken N</li> <li>Timken ES</li> <li>Timken V</li> </ul>	-40°F (-40°C) to 200°F (93°C) -40°F (-40°C) to 300°F (150°C) -22°F (-30°C) to 400°F (204°C)	3,000 to 90,000 (76.2 to 2286.0)	3,000 f/m (15.2 m/s)	Stainless steel finger	0.015 @ 1,000 (0.38 @ 5.10) 0.010 @ 2,000 (0.25 @ 10.20) 0.008 @ 5,000 (0.20 @ 25.40)	To 7 psi (0.4 bar)
 <b>Model 53G1</b>	<ul style="list-style-type: none"> <li>General purpose dual lip seal</li> <li>Gylon® excluder lip for non-lubricated external conditions or corrosive external conditons</li> </ul>	<ul style="list-style-type: none"> <li>Timken N</li> <li>Timken ES</li> <li>Timken V</li> </ul>	-40°F (-40°C) to 200°F (93°C) -40°F (-40°C) to 300°F (150°C) -22°F (-30°C) to 400°F (204°C)	3,000 to 40,000 (76.2 to 1016.0)	1,500 f/m (7.6 m/s)	Stainless steel finger	0.010 @ 1,500 (0.25 @ 7.60)	To 7 psi (0.4 bar)
 <b>Model 53R1</b>	<ul style="list-style-type: none"> <li>General purpose dual lip seal</li> <li>Dual lips oppose for exclusion and retention</li> <li>Spring in one element only</li> </ul>	<ul style="list-style-type: none"> <li>Timken N</li> <li>Timken ES</li> <li>Timken V</li> </ul>	-40°F (-40°C) to 200°F (93°C) -40°F (-40°C) to 300°F (150°C) -22°F (-30°C) to 400°F (204°C)	3,000 to 15,000 (76.2 to 381.0)	2,000 f/m (10.2 m/s)	Stainless steel finger	0.015 @ 1,000 (0.38 @ 5.10) 0.010 @ 2,000 (0.25 @ 10.20)	To 7 psi (0.4 bar)
 <b>Model 53R2</b>	<ul style="list-style-type: none"> <li>General purpose dual lip seal</li> <li>Dual lips oppose for exclusion and retention</li> <li>Spring in one element only</li> </ul>	<ul style="list-style-type: none"> <li>Timken N</li> <li>Timken ES</li> <li>Timken V</li> </ul>	-40°F (-40°C) to 200°F (93°C) -40°F (-40°C) to 300°F (150°C) -22°F (-30°C) to 400°F (204°C)	3,000 to 15,000 (76.2 to 381.0)	1,000 f/m (5.1 m/s)	Stainless steel finger	0.010 @ 500 (0.25 @ 2.50) 0.005 @ 1,000 (0.13 @ 5.10)	To 7 psi (0.4 bar)
 <b>Model 53TB</b>	<ul style="list-style-type: none"> <li>General purpose dual lip seal</li> <li>Lips set in tandem configuration</li> <li>Used for retention and exclusion</li> <li>Spring in both elements</li> <li>Carbon steel clamp</li> </ul>	<ul style="list-style-type: none"> <li>Timken N</li> <li>Timken ES</li> <li>Timken V</li> </ul>	-40°F (-40°C) to 200°F (93°C) -40°F (-40°C) to 300°F (150°C) -22°F (-30°C) to 400°F (204°C)	3,000 to 15,000 (76.2 to 381.0)	1,000 f/m (5.1 m/s)	Stainless steel finger	0.010 @ 500 (0.25 @ 2.50) 0.005 @ 1,000 (0.13 @ 5.10)	To 7 psi (0.4 bar)
 <b>Model 53TF</b>	<ul style="list-style-type: none"> <li>General purpose dual lip seal</li> <li>Lips set in tandem configuration</li> <li>Used for retention and exclusion</li> <li>Spring in both elements</li> <li>Carbon steel clamp</li> </ul>	<ul style="list-style-type: none"> <li>Timken N</li> <li>Timken ES</li> <li>Timken V</li> </ul>	-40°F (-40°C) to 200°F (93°C) -40°F (-40°C) to 300°F (150°C) -22°F (-30°C) to 400°F (204°C)	3,000 to 15,000 (76.2 to 381.0)	1,000 f/m (5.1 m/s)	Stainless steel finger	0.010 @ 500 (0.25 @ 2.50) 0.005 @ 1,000 (0.13 @ 5.10)	To 7 psi (0.4 bar)
 <b>Model 53T2</b>	<ul style="list-style-type: none"> <li>General purpose dual lip seal</li> <li>Lips set in tandem configuration</li> <li>Used for retention and exclusion</li> <li>Spring in both elements</li> <li>Carbon steel clamp</li> </ul>	<ul style="list-style-type: none"> <li>Timken N</li> <li>Timken ES</li> <li>Timken V</li> </ul>	-40°F (-40°C) to 200°F (93°C) -40°F (-40°C) to 300°F (150°C) -22°F (-30°C) to 400°F (204°C)	3,000 to 15,000 (76.2 to 381.0)	1,000 f/m (5.1 m/s)	Stainless steel finger	0.010 @ 500 (0.25 @ 2.50) 0.005 @ 1,000 (0.13 @ 5.10)	To 7 psi (0.4 bar)
 <b>Model 53F1</b>	<ul style="list-style-type: none"> <li>General purpose dual lip seal</li> <li>Heavy-duty metal outer case</li> <li>Felt excluder</li> </ul>	<ul style="list-style-type: none"> <li>Timken N</li> <li>Timken ES</li> <li>Timken V</li> </ul>	-40°F (-40°C) to 200°F (93°C) -40°F (-40°C) to 300°F (150°C) -22°F (-30°C) to 400°F (204°C)	3,000 to 15,000 (76.2 to 381.1)	1,000 f/m (5.1 m/s)	Stainless steel finger	0.010 @ 1,000 (0.25 @ 5.10)	To 7 psi (0.4 bar)
 <b>Model 63</b>	<ul style="list-style-type: none"> <li>General purpose assembled seal</li> <li>Heavy-duty metal outer case</li> <li>Stainless steel finger spring</li> <li>Single and dual lip configurations available</li> </ul>	<ul style="list-style-type: none"> <li>Timken N</li> <li>Timken ES</li> <li>Timken V</li> </ul>	-40°F (-40°C) to 200°F (93°C) -40°F (-40°C) to 300°F (150°C) -22°F (-30°C) to 400°F (204°C)	0.250 to 3,000 (6.4 to 76.2)	3,000 f/m (15.2 m/s)	Stainless steel finger	0.015 @ 1,000 (0.38 @ 5.10) 0.010 @ 2,000 (0.25 @ 10.20) 0.005 @ 3,000 (0.13 @ 15.20)	To 7 psi (0.4 bar)

\* Most designs available without spring.

\* Most designs available in silicone and other materials.

Large Seals	Features	Materials	Temperature	Shaft Diameter in. (mm)	Surface Speed f/m (7.6 m/s)	Spring Type	Misalign. in. @ f/m (mm@m/s)	Pressure
 <p><b>Model 63G1</b></p>	<ul style="list-style-type: none"> <li>General purpose dual lip seal</li> <li>Gylon® excluder lip for non-lubricated external conditions or corrosive external conditions</li> </ul>	<ul style="list-style-type: none"> <li>Timken N</li> <li>Timken ES</li> <li>Timken V</li> </ul>	<ul style="list-style-type: none"> <li>-40°F (-40°C) to 200°F (93°C)</li> <li>-40°F (-40°C) to 300°F (150°C)</li> <li>-22°F (-30°C) to 400°F (204°C)</li> </ul>	0.250 to 3.000 (6.4 to 76.2)	1,500 f/m (7.6 m/s)	Stainless steel finger	0.010 (0.25)	To 7 psi (0.4 bar)
 <p><b>Model 63R1</b></p>	<ul style="list-style-type: none"> <li>General purpose dual lip seal</li> <li>Dual lips oppose for exclusion and retention</li> <li>Spring in one element only</li> </ul>	<ul style="list-style-type: none"> <li>Timken N</li> <li>Timken ES</li> <li>Timken V</li> </ul>	<ul style="list-style-type: none"> <li>-40°F (-40°C) to 200°F (93°C)</li> <li>-40°F (-40°C) to 300°F (150°C)</li> <li>-22°F (-30°C) to 400°F (204°C)</li> </ul>	0.250 to 3.000 (6.4 to 76.2)	1,000 f/m (10.2 m/s)	Stainless steel finger	0.015 @ 1,000 (0.38 @ 5.10) 0.010 @ 2,000 (0.25 @ 10.20)	To 7 psi (0.4 bar)
 <p><b>Model 63R2</b></p>	<ul style="list-style-type: none"> <li>General purpose dual lip seal</li> <li>Dual lips oppose for exclusion and retention</li> <li>Spring in one element only</li> </ul>	<ul style="list-style-type: none"> <li>Timken N</li> <li>Timken ES</li> <li>Timken V</li> </ul>	<ul style="list-style-type: none"> <li>-40°F (-40°C) to 200°F (93°C)</li> <li>-40°F (-40°C) to 300°F (150°C)</li> <li>-22°F (-30°C) to 400°F (204°C)</li> </ul>	0.250 to 3.000 (6.4 to 76.2)	1,000 f/m (5.1 m/s)	Stainless steel finger	0.010 @ 500 (0.25 @ 2.50) 0.005 @ 1,000 (0.13 @ 5.10)	To 7 psi (0.4 bar)
 <p><b>Model 63TB</b></p>	<ul style="list-style-type: none"> <li>General purpose dual lip seal</li> <li>Non-sprung front lips serves as a baffle</li> <li>Lips set in tandem configuration</li> <li>Used for retention and exclusion</li> </ul>	<ul style="list-style-type: none"> <li>Timken N</li> <li>Timken ES</li> <li>Timken V</li> </ul>	<ul style="list-style-type: none"> <li>-40°F (-40°C) to 200°F (93°C)</li> <li>-40°F (-40°C) to 300°F (150°C)</li> <li>-22°F (-30°C) to 400°F (204°C)</li> </ul>	0.250 to 3.000 (6.4 to 76.2)	1,000 f/m (5.1 m/s)	Stainless steel finger	0.010 @ 500 (0.25 @ 2.50) 0.005 @ 1,000 (0.13 @ 5.10)	To 7 psi (0.4 bar)
 <p><b>Model 63TF</b></p>	<ul style="list-style-type: none"> <li>General purpose dual lip seal</li> <li>Non-sprung front lips serves as a baffle</li> <li>Lips set in tandem configuration</li> <li>Used for retention and exclusion</li> <li>Spring in both elements</li> </ul>	<ul style="list-style-type: none"> <li>Timken N</li> <li>Timken ES</li> <li>Timken V</li> </ul>	<ul style="list-style-type: none"> <li>-40°F (-40°C) to 200°F (93°C)</li> <li>-40°F (-40°C) to 300°F (150°C)</li> <li>-22°F (-30°C) to 400°F (204°C)</li> </ul>	0.250 to 3.000 (6.4 to 76.2)	1,000 f/m (5.1 m/s)	Stainless steel finger	0.010 @ 500 (0.25 @ 2.50) 0.005 @ 1,000 (0.13 @ 5.10)	To 7 psi (0.4 bar)
 <p><b>Model 63T2</b></p>	<ul style="list-style-type: none"> <li>General purpose dual lip seal</li> <li>Lips set in tandem configuration</li> <li>Used for retention and exclusion</li> <li>Spring in both elements</li> <li>Carbon steel clamp</li> </ul>	<ul style="list-style-type: none"> <li>Timken N</li> <li>Timken ES</li> <li>Timken V</li> </ul>	<ul style="list-style-type: none"> <li>-40°F (-40°C) to 200°F (93°C)</li> <li>-40°F (-40°C) to 300°F (150°C)</li> <li>-22°F (-30°C) to 400°F (204°C)</li> </ul>	0.250 to 3.000 (6.4 to 76.2)	1,000 f/m (5.1 m/s)	Stainless steel finger	0.010 @ 500 (0.25 @ 2.50) 0.005 @ 1,000 (0.13 @ 5.10)	To 7 psi (0.4 bar)
 <p><b>Model 63F1</b></p>	<ul style="list-style-type: none"> <li>General purpose dual lip seal</li> <li>Felt excluder</li> </ul>	<ul style="list-style-type: none"> <li>Timken N</li> <li>Timken ES</li> <li>Timken V</li> </ul>	<ul style="list-style-type: none"> <li>-40°F (-40°C) to 200°F (93°C)</li> <li>-40°F (-40°C) to 300°F (150°C)</li> <li>-22°F (-30°C) to 400°F (204°C)</li> </ul>	0.250 to 3.000 (6.4 to 76.2)	1,000 f/m (5.1 m/s)	Stainless steel finger	0.010 @ 500 (0.25 @ 2.50)	To 7 psi (0.4 bar)

Small Seals Bonded Seals	Features	Materials	Temperature	Shaft Diameter in. (mm)	Surface Speed	Spring Type	Misalign. in. @ f/m (mm@m/s)	Pressure
 <b>Model 71</b>	<ul style="list-style-type: none"> <li>General purpose bonded seal</li> <li>No spring</li> <li>Ideal for grease retention or contamination exclusion</li> </ul>	<ul style="list-style-type: none"> <li>Nitrile</li> <li>Fluoroelastomer</li> </ul>	-40°F (-40°C) to 200°F (93°C) -40°F (-40°C) to 400°F (204°C)	0.250 to 7.250 (6.3 to 184.1)	1,000 f/m (5.1 m/s)	N/A	0.005 @ 1,000 (0.13 @ 5.10)	To 7 psi (0.4 bar)
 <b>Model 76</b>	<ul style="list-style-type: none"> <li>Special purpose bonded seal</li> <li>Metal outer case</li> <li>Garter spring construction</li> </ul>	<ul style="list-style-type: none"> <li>Nitrile</li> <li>Fluoroelastomer</li> </ul>	-40°F (-40°C) to 200°F (93°C) -40°F (-40°C) to 400°F (204°C)	0.250 to 8.000 (6.3 to 203.2)	3,000 f/m (15.2 m/s)	Carbon steel garter	0.015 @ 1,000 (0.38 @ 5.10) 0.010 @ 2,000 (0.25 @ 10.20) 0.005 @ 3,000 (0.13 @ 15.20)	To 7 psi (0.4 bar)
 <b>Model 91</b>	<ul style="list-style-type: none"> <li>General purpose bonded seal</li> <li>No spring</li> <li>Ideal for grease retention or contamination exclusion</li> </ul>	<ul style="list-style-type: none"> <li>Nitrile</li> <li>Fluoroelastomer</li> </ul>	-40°F (-40°C) to 200°F (93°C) -40°F (-40°C) to 400°F (204°C)	0.281 to 5.000 (7.1 to 127.0)	1,000 f/m (5.1 m/s)	N/A	0.005 @ 1,000 (0.13 @ 5.10)	To 7 psi (0.4 bar)
 <b>Model 92</b>	<ul style="list-style-type: none"> <li>General purpose bonded seal</li> <li>Metal outer case</li> <li>Garter spring construction</li> </ul>	<ul style="list-style-type: none"> <li>Nitrile</li> <li>Fluoroelastomer</li> </ul>	-40°F (-40°C) to 200°F (93°C) -40°F (-40°C) to 400°F (204°C)	3.000 to 15.000 (76.2 to 381.0)	1,000 f/m (5.1 m/s)	Carbon steel garter	0.010 @ 500 (0.25 @ 2.50) 0.005 @ 1,000 (0.13 @ 5.10) 22°F (-30°C) to 400°F (204°C)	To 7 psi (0.4 bar)
 <b>Model 94</b>	<ul style="list-style-type: none"> <li>General purpose bonded seal</li> <li>Metal outer case</li> <li>Dual lip design</li> <li>Garter spring construction</li> </ul>	<ul style="list-style-type: none"> <li>Nitrile</li> <li>Fluoroelastomer</li> </ul>	-40°F (-40°C) to 200°F (93°C) -40°F (-40°C) to 400°F (204°C)	0.438 to 7.375 (11.1 to 187.3)	3,000 f/m (15.2 m/s)	Carbon steel garter	0.015 @ 1,000 (0.38 @ 5.10) 0.010 @ 2,000 (0.25 @ 10.20) 0.005 @ 3,000 (0.13 @ 15.20)	To 7 psi (0.4 bar)
Split Seals	Features	Materials	Temperature	Shaft Diameter in. (mm)	Surface Speed	Spring Type	Misalign. in. @ f/m (mm@m/s)	Pressure
 <b>Model 21</b>	<ul style="list-style-type: none"> <li>General purpose split seal</li> <li>Low-speed service</li> <li>Cover plate required</li> </ul>	<ul style="list-style-type: none"> <li>Timken N</li> <li>Timken ES</li> <li>Timken V</li> </ul>	-40°F (-40°C) to 200°F (93°C) -40°F (-40°C) to 300°F (150°C) -22°F (-30°C) to 400°F (204°C)	3.000 to 15.000 (76.2 to 381.0)	1,000 f/m (5.1 m/s)	Mold-in stainless steel finger	0.010 @ 500 (0.25 @ 2.50) 0.005 @ 1,000 (0.13 @ 5.10)	N/A
 <b>Model 23</b>	<ul style="list-style-type: none"> <li>General service split seal</li> <li>Cover plate required</li> <li>Over 300,000 sizes readily available</li> </ul>	<ul style="list-style-type: none"> <li>Timken N</li> <li>Timken ES</li> <li>Timken V</li> </ul>	-40°F (-40°C) to 200°F (93°C) -40°F (-40°C) to 300°F (150°C) -22°F (-30°C) to 400°F (204°C)	3.000 to 15.000 (76.2 to 381.0)	1,000 f/m (5.1 m/s)	Mold-in stainless steel finger	0.010 @ 1,000 (0.25 @ 5.10) 0.005 @ 2,000 (0.13 @ 10.20)	N/A
 <b>Model 24</b>	<ul style="list-style-type: none"> <li>Special purpose split seal for tapered housing grooves</li> <li>Low-speed service</li> <li>Tapered O.D.</li> </ul>	<ul style="list-style-type: none"> <li>Timken N</li> <li>Timken ES</li> <li>Timken V</li> </ul>	-40°F (-40°C) to 200°F (93°C) -40°F (-40°C) to 300°F (150°C) -22°F (-30°C) to 400°F (204°C)	3.000 to 15.000 (76.2 to 381.1)	1,000 f/m (5.1 m/s)	Mold-in stainless steel finger	0.010 @ 500 (0.25 @ 2.50) 0.005 @ 1,000 (0.13 @ 5.10)	N/A
 <b>Model 25</b>	<ul style="list-style-type: none"> <li>PTFE split seal</li> <li>Low-speed service</li> <li>Excellent chemical resistance</li> <li>Cover plate required</li> </ul>	<ul style="list-style-type: none"> <li>PTFE</li> </ul>	-120°F (-85°C) to 400°F (205°C)	3.000 to 20.000 (76.2 to 508.0)	1,000 f/m (5.1 m/s)	Carbon steel garter	0.010 @ 500 (0.25 @ 2.50) 0.005 @ 1,000 (0.13 @ 5.10)	N/A

\* Most designs available without spring.

\* Most designs available in silicone and other materials.

Split Seals	Features	Materials	Temperature	Shaft Diameter in. (mm)	Surface Speed	Spring Type	Misalign. in. @ f/m (mm@m/s)	Pressure
 <p><b>Model 26</b></p>	<ul style="list-style-type: none"> <li>• General purpose bonded seal</li> <li>• No spring</li> <li>• Ideal for grease retention or contamination exclusion</li> </ul>	<ul style="list-style-type: none"> <li>• Timken N</li> <li>• Timken ES</li> <li>• Timken V</li> </ul>	<ul style="list-style-type: none"> <li>• -40°F (-40°C) to 200°F (93°C)</li> <li>• -40°F (-40°C) to 300°F (150°C)</li> <li>• -22°F (-30°C) to 400°F (204°C)</li> </ul>	0.750 to 60.000 (19.0 to 1524.0)	5,000 f/m (25.4 m/s)	Mold-in stainless steel finger	0.015 @ 1,000 (0.38 @ 5.10) 0.010 @ 2,000 (0.25 @ 10.20) 0.008 @ 5,000 (0.20 @ 25.40)	To 7 psi (0.4 bar)
 <p><b>Model 26R1</b></p>	<ul style="list-style-type: none"> <li>• Special purpose bonded seal</li> <li>• Metal outer case</li> <li>• Garter spring construction</li> </ul>	<ul style="list-style-type: none"> <li>• Timken N</li> <li>• Timken ES</li> <li>• Timken V</li> </ul>	<ul style="list-style-type: none"> <li>• -40°F (-40°C) to 200°F (93°C)</li> <li>• -40°F (-40°C) to 300°F (150°C)</li> <li>• -22°F (-30°C) to 400°F (204°C)</li> </ul>	0.750 to 60.000 (19.05 to 1524.0)	5,000 f/m (25.4 m/s)	Mold-in stainless steel finger	0.015 @ 1,000 (0.38 @ 5.10) 0.010 @ 2,000 (0.25 @ 10.20) 0.008 @ 5,000 (0.20 @ 25.40)	To 7 psi (0.4 bar)
Excluder Seals	Features	Materials	Temperature	Shaft Diameter in. (mm)	Surface Speed	Spring Type	Misalign. in. @ f/m (mm@m/s)	Pressure
 <p><b>Model 143</b></p>	<ul style="list-style-type: none"> <li>• General purpose bonded seal</li> <li>• No spring</li> <li>• Ideal for grease retention or contamination exclusion</li> </ul>	<ul style="list-style-type: none"> <li>• Nitrile</li> <li>• Timken ES</li> <li>• Timken V</li> </ul>	<ul style="list-style-type: none"> <li>• 200°F (93°C)</li> <li>• -40°F (-40°C) to 400°F (204°C)</li> </ul>	5.000 (7.1 to 127.0)	(5.1 m/s)			
 <p><b>Model 145A</b></p>	<ul style="list-style-type: none"> <li>• General purpose bonded seal</li> <li>• Metal outer case</li> <li>• Garter spring construction</li> </ul>	<ul style="list-style-type: none"> <li>• Nitrile</li> <li>• Fluoroelastomer</li> </ul>	<ul style="list-style-type: none"> <li>• -40°F (-40°C) to 200°F (93°C)</li> <li>• -40°F (-40°C) to 400°F (204°C)</li> </ul>	3.000 to 15.000 (76.2 to 381.0)	1,000 f/m (5.1 m/s)	N/A	N/A	N/A
 <p><b>Model 145A1</b></p>	<ul style="list-style-type: none"> <li>• General purpose bonded seal</li> <li>• Metal outer case</li> <li>• Dual lip design</li> <li>• Garter spring construction</li> </ul>	<ul style="list-style-type: none"> <li>• Nitrile</li> <li>• Timken ES</li> <li>• Timken V</li> </ul>	<ul style="list-style-type: none"> <li>• -40°F (-40°C) to 200°F (93°C)</li> <li>• -40°F (-40°C) to 400°F (204°C)</li> </ul>	0.438 to 7.375 (11.1 to 187.3)	3,000 f/m (15.2 m/s)	Stainless steel garter	N/A	N/A
 <p><b>Model 145A2</b></p>	<ul style="list-style-type: none"> <li>• General purpose split seal</li> <li>• Low-speed service</li> <li>• Cover plate required</li> </ul>	<ul style="list-style-type: none"> <li>• Nitrile</li> <li>• Timken ES</li> <li>• Timken V</li> </ul>	<ul style="list-style-type: none"> <li>• -40°F (-40°C) to 200°F (93°C)</li> <li>• -40°F (-40°C) to 300°F (150°C)</li> <li>• -22°F (-30°C) to 400°F (204°C)</li> </ul>	3.000 to 15.000 (76.2 to 381.0)	1,000 f/m (5.1 m/s)	Stainless steel garter	N/A	N/A
 <p><b>Model 145L</b></p>	<ul style="list-style-type: none"> <li>• General service split seal</li> <li>• Cover plate required</li> <li>• Over 300,000 sizes readily available</li> </ul>	<ul style="list-style-type: none"> <li>• Nitrile</li> <li>• Fluoroelastomer</li> </ul>	<ul style="list-style-type: none"> <li>• -40°F (-40°C) to 200°F (93°C)</li> <li>• -40°F (-40°C) to 300°F (150°C)</li> <li>• -22°F (-30°C) to 400°F (204°C)</li> </ul>	3.000 to 15.000 (76.2 to 381.0)	1,000 f/m (5.1 m/s)	N/A	N/A	N/A
 <p><b>Model 145S</b></p>	<ul style="list-style-type: none"> <li>• Special purpose split seal for tapered housing grooves</li> <li>• Low-speed service</li> <li>• Tapered O.D.</li> </ul>	<ul style="list-style-type: none"> <li>• Nitrile</li> <li>• Fluoroelastomer</li> </ul>	<ul style="list-style-type: none"> <li>• -40°F (-40°C) to 200°F (93°C)</li> <li>• -40°F (-40°C) to 300°F (150°C)</li> <li>• -22°F (-30°C) to 400°F (204°C)</li> </ul>	3.000 to 15.000 (76.2 to 381.1)	1,000 f/m (5.1 m/s)	N/A	N/A	N/A

\* Most designs available without spring.







\* Most designs available in silicone and other materials.



Excluder Seals	Features	Materials	Temperature	Shaft Diameter in. (mm)	Surface Speed	Spring Type	Misalign. in. @ f/m (mm@m/s)	Pressure
 <b>Model 26E</b>	<ul style="list-style-type: none"> <li>General purpose external seal</li> <li>Solid design</li> <li>Reverse bevel lip design prevents lip rollover</li> <li>Reinforced rubber OD</li> </ul>	<ul style="list-style-type: none"> <li>Timken N</li> <li>Timken ES</li> <li>Timken V</li> </ul>	-40°F (-40°C) to 200°F (93°C) -40°F (-40°C) to 300°F (150°C) -22°F (-30°C) to 400°F (204°C)	1.000 to 60.000 (25.4 to 1524.0)	5,000 f/m (25.4 m/s)	Stainless	0.015 @ 1,000 (0.38 @ 5.10) 0.010 @ 2,000 (0.25 @ 10.20) 0.008 @ 5,000 (0.20 @ 25.40)	To 7 psi (0.4 bar)
 <b>Model 111</b>	<ul style="list-style-type: none"> <li>Heavy-duty metal outer case</li> <li>Low speed service</li> <li>Assembled design</li> </ul>	<ul style="list-style-type: none"> <li>Timken N</li> <li>Timken ES</li> <li>Timken V</li> </ul>	-40°F (-40°C) to 200°F (93°C) -40°F (-40°C) to 300°F (150°C) -22°F (-30°C) to 400°F (204°C)	3.000 to 50.000 (76.2 to 1270)	1,000 f/m (5.1 m/s)	Stainless steel finger	0.010 @ 500 (0.25 @ 2.50) 0.005 @ 1,000 (0.13 @ 5.10)	To 7 psi (0.4 bar)
 <b>Model 113</b>	<ul style="list-style-type: none"> <li>Heavy-duty metal outer case</li> <li>Assembled design</li> </ul>	<ul style="list-style-type: none"> <li>Timken N</li> <li>Timken ES</li> <li>Timken V</li> </ul>	-40°F (-40°C) to 200°F (93°C) -40°F (-40°C) to 300°F (150°C) -22°F (-30°C) to 400°F (204°C)	3.000 to 50.000 (76.2 to 1270)*	3,000 f/m (15.2 m/s)	Stainless steel finger	0.020 @ 1,000 (0.50 @ 5.10) 0.010 @ 2,000 (0.25 @ 10.20) 0.005 @ 3,000 (0.13 @ 15.20)	To 7 psi (0.4 bar)
 <b>Model 123</b>	<ul style="list-style-type: none"> <li>Heavy-duty metal outer case</li> <li>Assembled design</li> </ul>	<ul style="list-style-type: none"> <li>Timken N</li> <li>Timken ES</li> <li>Timken V</li> </ul>	-40°F (-40°C) to 200°F (93°C) -40°F (-40°C) to 300°F (150°C) -22°F (-30°C) to 400°F (204°C)	1.156 to 50.000 (29.4 to 1270)	3,000 f/m (15.2 m/s)	Stainless steel finger	0.020 @ 1,000 (0.50 @ 5.10) 0.010 @ 2,000 (0.25 @ 10.20) 0.005 @ 3,000 (0.13 @ 15.20)	To 7 psi (0.4 bar)
Specialty Seals	Features	Materials	Temperature	Shaft Diameter in. (mm)	Surface Speed	Spring Type	Misalign. in. @ f/m (mm@m/s)	Pressure
 <b>P/S® Single Lip</b>	<ul style="list-style-type: none"> <li>General purpose assembled seal for high pressure applications</li> <li>Gylon® element offers excellent chemical resistance</li> <li>Dry running up to 700 fpm (3.5 m/s)</li> </ul>	<ul style="list-style-type: none"> <li>Gylon®</li> <li>FDA Gylon®</li> </ul>	-40°F (-40°C) to 200°F (93°C) -40°F (-40°C) to 300°F (150°C) -22°F (-30°C) to 400°F (204°C)	0.438 to 20.000 (11.1 to 508.0) max seal O.D.	2,000 f/m (10.2 m/s)	N/A	0.005 @ 2,000 (0.13 @ 10.20)	150 psi (10 bar)
 <b>P/S® Single Lip Reverse</b>	<ul style="list-style-type: none"> <li>General purpose assembled seal for high pressure applications</li> <li>Gylon® element offers excellent chemical resistance</li> <li>Dry running up to 700 fpm (3.5 m/s)</li> </ul>	<ul style="list-style-type: none"> <li>Gylon®</li> <li>FDA Gylon®</li> </ul>	-40°F (-40°C) to 200°F (93°C) -40°F (-40°C) to 300°F (150°C) -22°F (-30°C) to 400°F (204°C)	0.438 to 20.000 (11.1 to 508.0) max seal O.D.	2,000 f/m (10.2 m/s)	N/A	0.005 @ 2,000 (0.13 @ 10.20)	150 psi (10 bar)
 <b>P/S® Dual Opposed</b>	<ul style="list-style-type: none"> <li>General purpose assembled seal for high pressure applications</li> <li>Gylon® element offers excellent chemical resistance</li> <li>Dry running up to 700 fpm (3.5 m/s)</li> </ul>	<ul style="list-style-type: none"> <li>Gylon®</li> <li>FDA Gylon®</li> </ul>	-40°F (-40°C) to 200°F (93°C) -40°F (-40°C) to 300°F (150°C) -22°F (-30°C) to 400°F (204°C)	0.438 to 20.000 (11.1 to 508.0) max seal O.D.	2,000 f/m (10.2 m/s)	N/A	0.005 @ 2,000 (0.13 @ 10.20)	150 psi (10 bar)
 <b>P/S® Dual Tandem</b>	<ul style="list-style-type: none"> <li>General purpose assembled seal for high pressure applications</li> <li>Gylon® element offers excellent chemical resistance</li> <li>Dry running up to 700 fpm (3.5 m/s)</li> </ul>	<ul style="list-style-type: none"> <li>Gylon®</li> <li>FDA Gylon®</li> </ul>	-40°F (-40°C) to 200°F (93°C) -40°F (-40°C) to 300°F (150°C) -22°F (-30°C) to 400°F (204°C)	0.438 to 20.000 (11.1 to 508.0) max seal O.D.	2,000 f/m (10.2 m/s)	N/A	0.005 @ 2,000 (0.13 @ 10.20)	150 psi (10 bar)











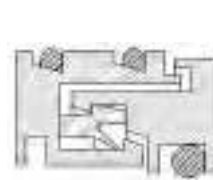







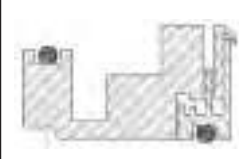
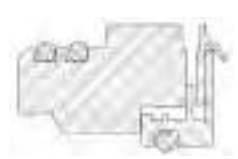

\* Most designs available without spring.

\* Most designs available in silicone and other materials.

Specialty Seals	Features	Materials	Temperature	Shaft Diameter in. (mm)	Surface Speed	Spring Type	Misalign. in. @ f/m (mm@m/s)	Pressure
 <p><b>Model 26HR</b></p>	<ul style="list-style-type: none"> <li>• General purpose seal for high misalignment applications</li> <li>• Low-speed service</li> <li>• Increased misalignment capability over standard 26</li> </ul>	<ul style="list-style-type: none"> <li>• Timken N</li> <li>• Timken ES</li> <li>• Timken V</li> </ul>	<ul style="list-style-type: none"> <li>• -40°F (-40°C) to 200°F (93°C)</li> <li>• -40°F (-40°C) to 300°F (150°C)</li> <li>• -22°F (-30°C) to 400°F (204°C)</li> </ul>	1.000 to 5.000 (25.4 to 127.0)	1,000 f/m (5.1 m/s)	Molded-in carbon steel garter	Application dependent	To 7 psi (0.4 bar)
 <p><b>Model 50</b></p>	<ul style="list-style-type: none"> <li>• General purpose seal</li> <li>• Low-speed service</li> <li>• Moderate pressure</li> </ul>	<ul style="list-style-type: none"> <li>• Timken N</li> </ul>	<ul style="list-style-type: none"> <li>• -40°F (-40°C) to 200°F (93°C)</li> </ul>	5.000 to 12.000 (127.0 to 304.8)	1,000 f/m (5.1 m/s)	Molded-in carbon steel garter	0.010 (0.25)	To 35 psi (2.4 bar)
 <p><b>Model 54</b></p>	<ul style="list-style-type: none"> <li>• Special purpose assembled seal</li> <li>• Excluder seal</li> <li>• Designed for spherical bearing applications</li> </ul>	<ul style="list-style-type: none"> <li>• Timken N</li> </ul>	<ul style="list-style-type: none"> <li>• -40°F (-40°C) to 200°F (93°C)</li> </ul>	For spherical radii from 2.375 to 8.000 (60.33 to 203.2)	1,000 f/m (5.1 m/s)	Stainless steel finger	N/A	To 50 psi (3.4 bar)
 <p><b>Model 57</b></p>	<ul style="list-style-type: none"> <li>• General purpose seal</li> <li>• Metal reinforced rubber O.D.</li> <li>• Reverse bevel lip design prevents lip rollover</li> <li>• Available in single &amp; dual lip</li> <li>• Ideal for slow-speed service applications (continuous casters)</li> </ul>	<ul style="list-style-type: none"> <li>• Timken N</li> <li>• Timken ES</li> <li>• Timken V</li> </ul>	<ul style="list-style-type: none"> <li>• -40°F (-40°C) to 200°F (93°C)</li> <li>• -40°F (-40°C) to 300°F (150°C)</li> <li>• -22°F (-30°C) to 400°F (204°C)</li> </ul>	2.000 to 12.000 (50.8 to 304.8)	500 f/m (2.5 m/s)	Molded-in carbon steel garter	0.015 @ 500 (0.38 @ 2.50)	To 7 psi (0.4 bar)
 <p><b>Model 58</b></p>	<ul style="list-style-type: none"> <li>• High-temp, general purpose assembled seal</li> <li>• Stainless steel outer case</li> <li>• THERMO-CERAM™ sealing element</li> <li>• Ideal for abrasive environments</li> <li>• Grease lubricated apps only</li> </ul>	<ul style="list-style-type: none"> <li>• THERMO-CERAM™</li> </ul>	<ul style="list-style-type: none"> <li>• To 1600°F (871°C)</li> </ul>	2.000 to 12.000 (50.8 to 304.8)	500 f/m (2.5 m/s)	N/A	0.015 @ 500 (0.38 @ 2.50)	Ambient
 <p><b>Model 62</b></p>	<ul style="list-style-type: none"> <li>• Assembled seal</li> <li>• Solid design</li> <li>• Low-speed service</li> <li>• Excellent chemical resistance</li> </ul>	<ul style="list-style-type: none"> <li>• PTFE</li> </ul>	<ul style="list-style-type: none"> <li>• -120°F (-85°C) to 400°F (205°C)</li> </ul>	0.437 to 20.000 (11.1 to 508.0) in max seal O.D.	2,000 f/m (10.2 m/s)	Carbon steel garter	0.005 @ 2,000 (0.13 @ 10.20)	To 7 psi (0.4 bar)

\* Most designs available without spring.

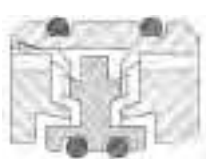
\* Most designs available in silicone and other materials.

<p><b>Metallic Isolator – Flanged</b></p> 	<p><b>Metallic Isolator – Flangeless</b></p> 	<p><b>Metallic Isolator – Narrow Width</b></p> 	<p><b>Metallic Isolator – Small C-S</b></p> 	<p><b>Metallic Isolator – SPB</b></p> 
<p><b>Metallic Isolator – Step Shaft</b></p> 	<p><b>Metallic Isolator – Vertical</b></p> 	<p><b>Metallic Isolator – Vertical</b></p> 	<p><b>Non-Metallic Isolator (Glass-Filled PTFE) – Flanged</b></p> 	<p><b>Non-Metallic Isolator (Glass-Filled PTFE) – Flanged</b></p> 
<p><b>Non-Metallic Isolator (Glass-Filled PTFE) – Flangeless</b></p> 	<p><b>Non-Metallic Isolator (Glass-Filled PTFE) – Grease Purge</b></p> 	<p><b>Non-Metallic Isolator (Glass-Filled PTFE) – Small C-S</b></p> 	<p><b>Non-Metallic Isolator (Glass-Filled PTFE) – SPB</b></p> 	<p><b>Non-Metallic Isolator (Glass-Filled PTFE) – Step Shaft</b></p> 
<p><b>Non-Metallic Isolator (Glass-Filled PTFE) – Vertical</b></p> 	<p><b>Non-Metallic Isolator (Glass-Filled PTFE) – Vertical</b></p> 	<p><b>Metallic Isolator (Microcellular Filter)</b></p> 	<p><b>Metallic Isolator (Microcellular Filter) Flangeless</b></p> 	<p><b>Non-Metallic Isolator (Graphite-Filled PTFE)</b></p> 
<p><b>Non-Metallic Isolator (Graphite-Filled PTFE) – Flangeless</b></p> 	<p><b>Non-Metallic Isolator (Graphite-Filled PTFE) – Small C-S</b></p> 			

## Bearing Isolators Configurations

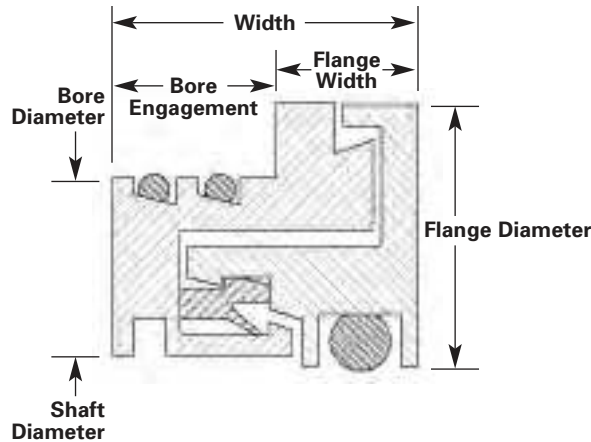

Metallic Isolator Seal Sizes Code Prefix	Description	Material	Width	Flange Width	Bore Engagement
29602	Standard	Bronze	0.700	0.325	0.375
29604	Standard	316 Stainless Steel	0.700	0.325	0.375
29606	Small Cross Section	316 Stainless Steel	0.625	0.375	0.250
29607	Small Cross Section	Bronze	0.625	0.375	0.250
29608	Small Cross Section, Short Flange	Bronze	0.625	0.250	0.375
29609	Narrow Width Flangeless	Bronze	0.375	N/A	0.375
29610	Small Flanged	Bronze	0.700	0.325	0.375
29611	Narrow Width Flangeless	316 Stainless Steel	0.375	N/A	0.375
29612	Flangeless	316 Stainless Steel	0.625	N/A	0.625
29616	Split Pillow Block	Bronze	1.000	0.500	0.500
29619	Flangeless	Bronze	0.625	N/A	0.625
29620	Vertical	Bronze	0.700	0.325	0.375
29621	Vertical - Small Cross Section	Bronze	0.625	0.375	0.250
Metallic Isolator (Microcellular Filter) Seal Sizes Code Prefix	Description	Material	Width	Flange Width	Bore Engagement
29102	Standard	Bronze	0.700	0.325	0.375
29106	Standard	316 Stainless Steel	0.700	0.325	0.375
29119	Flangeless	Bronze	0.625	N/A	0.625
Non-Metallic Isolator (Glass-Filled PTFE) Seal Sizes Code Prefix	Description	Material	Width	Flange Width	Bore Engagement
29500	Standard Style 2 O.D. O-Rings	Glass-Filled PTFE	0.750	0.300	0.450
29502	Standard	Glass-Filled PTFE	0.750	0.375	0.375
29507	Small Cross Section	Glass-Filled PTFE	0.625	0.375	0.250
29516	Split Pillow Block	Glass-Filled PTFE	1.000	0.500	0.500
29518	Grease Purgeable	Glass-Filled PTFE	0.820	0.320	0.500
29519	Flangeless	Glass-Filled PTFE	0.640	N/A	0.625
29520	Vertical	Glass-Filled PTFE	0.760	0.385	0.375
29521	Vertical - Two O.D. O-Rings	Glass-Filled PTFE	0.885	0.385	0.500
Non-Metallic Isolator (Graphite-Filled PTFE) Seal Sizes Code Prefix	Description	Material	Width	Flange Width	Bore Engagement
24801	Flangeless	Graphite-Filled PTFE	0.625	N/A	0.625
24802	Standard	Graphite-Filled PTFE	0.625	0.250	0.375
24807	Small Cross Section	Graphite-Filled PTFE	0.625	0.250	0.375

Metallic Isolator Model Number	Features	Materials	Temperature	Shaft Diameter in. (mm)	Surface Speed	Axial Motion in. (mm)	Misalign. & Runout in. @ f/m (mm@m/s)	Pressure
<b>Standard, Small Flanged</b> 	<ul style="list-style-type: none"> <li>• Meets NEMA MG 1-2003</li> <li>• Meets IEEE 841-2001 test standards</li> <li>• Conforms to API 610</li> <li>• No arbor press required for installation</li> <li>• No internal metal-to-metal contact</li> <li>• Small O.D. of flange does not interfere with equipment</li> </ul>	<ul style="list-style-type: none"> <li>• Bronze or 316 stainless steel construction</li> <li>• Filled PTFE unitizing ring</li> <li>• Fluoroelastomer</li> </ul>	-30°F (-34°C) to 400°F (204°C)	0.875 to 10.500 (22.2 to 266.7)	12,000 f/m (60.9 m/s)	±0.025 (0.64)	±0.020 (0.51)	Ambient
<b>Small Cross Section, Short Flange</b> 	<ul style="list-style-type: none"> <li>• Meets NEMA MG 1-2003</li> <li>• Meets IEEE 841-2001 test standards</li> <li>• Conforms to API 610</li> <li>• No arbor press required for installation</li> <li>• No internal metal-to-metal contact</li> <li>• Fits in c/s as small as 0.188" (4.76mm)</li> <li>• Short flange width does not interfere with equipment</li> </ul>	<ul style="list-style-type: none"> <li>• Bronze or 316 stainless steel construction</li> <li>• Filled PTFE unitizing ring</li> <li>• Fluoroelastomer O-rings standard</li> </ul>	-30°F (-34°C) to 400°F (204°C)	0.875 to 5.500 (22.2 to 139.7)	12,000 f/m (60.9 m/s)	±0.015 (0.38)	±0.010 (0.25)	Ambient
<b>Flangeless Narrow Width</b> 	<ul style="list-style-type: none"> <li>• Meets NEMA MG 1-2003</li> <li>• Meets IEEE 841-2001 test standards</li> <li>• No arbor press required for installation</li> <li>• No internal metal-to-metal contact</li> <li>• Flangeless design fits in spaces as narrow as 0.375" (9.53mm)</li> </ul>	<ul style="list-style-type: none"> <li>• Bronze or 316 stainless steel construction</li> <li>• Filled PTFE unitizing ring</li> <li>• Fluoroelastomer O-rings standard</li> </ul>	-30°F (-34°C) to 400°F (204°C)	0.875 to 5.500 (22.2 to 139.7)	12,000 f/m (60.9 m/s)	±0.015 (0.38)	±0.010 (0.25)	Ambient
<b>Flangeless</b> 	<ul style="list-style-type: none"> <li>• Meets NEMA MG 1-2003</li> <li>• Meets IEEE 841-2001 test standards</li> <li>• Conforms to API 610</li> <li>• No arbor press required for installation</li> <li>• No internal metal-to-metal contact</li> <li>• Does not extend past face of housing</li> </ul>	<ul style="list-style-type: none"> <li>• Bronze or 316 stainless steel construction</li> <li>• Filled PTFE unitizing ring</li> <li>• Fluoroelastomer O-rings standard</li> </ul>	-30°F (-34°C) to 400°F (204°C)	0.875 to 10.500 (22.2 to 266.7)	12,000 f/m (60.9 m/s)	±0.025 (0.64)	±0.020 (0.51)	Ambient
<b>Split Pillow Block</b> 	<ul style="list-style-type: none"> <li>• Meets NEMA MG 1-2003</li> <li>• Meets IEEE 841-2001 test standards</li> <li>• Conforms to API 610</li> <li>• No arbor press required for installation</li> <li>• No internal metal-to-metal contact</li> <li>• Standard and custom design for split pillow blocks</li> </ul>	<ul style="list-style-type: none"> <li>• Bronze or 316 stainless steel construction</li> <li>• Filled PTFE unitizing ring</li> <li>• Fluoroelastomer O-rings standard</li> </ul>	-30°F (-34°C) to 400°F (204°C)	0.875 to 10.500 (22.2 to 266.7)	12,000 f/m (60.9 m/s)	±0.025 (0.64)	±0.020 (0.51)	Ambient
<b>Step Shaft</b> 	<ul style="list-style-type: none"> <li>• Meets NEMA MG 1-2003</li> <li>• Surpasses IEEE 841-2001 test standards</li> <li>• Conforms to API 610</li> <li>• No arbor press required for installation</li> <li>• No internal metal-to-metal contact</li> <li>• Custom designed for individual step shaft applications</li> </ul>	<ul style="list-style-type: none"> <li>• Bronze or 316 stainless steel construction</li> <li>• Filled PTFE unitizing ring</li> <li>• Fluoroelastomer O-rings standard</li> </ul>	-30°F (-34°C) to 400°F (204°C)	0.875 to 10.500 (22.2 to 266.7)	12,000 f/m (60.9 m/s)	±0.025 (0.64)	±0.020 (0.51)	Ambient
<b>Vertical, Small Cross Section</b> 	<ul style="list-style-type: none"> <li>• Meets NEMA MG 1-2003</li> <li>• Surpasses IEEE 841-2001 test standards</li> <li>• Conforms to API 610</li> <li>• No arbor press required for installation</li> <li>• No internal metal-to-metal contact</li> <li>• Fits in c/s as small as 0.188 in. (4.76mm)</li> <li>• Vertical design for top applications only</li> </ul>	<ul style="list-style-type: none"> <li>• Bronze or 316 stainless steel construction</li> <li>• Filled PTFE unitizing ring</li> <li>• Fluoroelastomer O-rings standard</li> </ul>	-30°F (-34°C) to 400°F (204°C)	0.875 to 10.500 (22.2 to 266.7)	12,000 f/m (60.9 m/s)	±0.025 (0.64)	±0.020 (0.51)	Ambient

## Bearing Isolators Product Information

Metallic Isolator (Microcellular Filter)	Features	Materials	Temperature	Shaft Diameter in. (mm)	Surface Speed	Axial Motion in. (mm)	Misalign. & Runout in. @ f/m (mm@m/s)	Pressure
 <p><b>Standard</b></p>	<ul style="list-style-type: none"> <li>• Unique microcellular technology</li> <li>• Protects against severely dusty environments</li> <li>• Meets NEMA MG 1-2003</li> <li>• Surpasses IEEE 841-2001 test standards</li> <li>• Conforms to API 610</li> <li>• No arbor press required for installation</li> <li>• No internal metal-to-metal contact</li> </ul>	<ul style="list-style-type: none"> <li>• Bronze or 316 stainless steel construction</li> <li>• Silicone foam</li> <li>• Filled PTFE unitizing ring</li> <li>• Fluoroelastomer O-ring standard</li> </ul>	-30°F (-34°C) to 400°F (204°C)	0.875 to 10.500 (22.2 to 266.7)	4,500 f/m (22.9 m/s)	±0.025 (0.64)	±0.020 (0.51)	Ambient
 <p><b>Flangeless</b></p>	<ul style="list-style-type: none"> <li>• Unique microcellular technology</li> <li>• Protects against severely dusty environments</li> <li>• Meets NEMA MG 1-2003</li> <li>• Meets IEEE 841-2001 test standards</li> <li>• Conforms to API 610</li> <li>• No arbor press required for installation</li> <li>• No internal metal-to-metal contact</li> <li>• Does not extend past face housing</li> </ul>	<ul style="list-style-type: none"> <li>• Bronze construction</li> <li>• Silicone foam</li> <li>• Filled PTFE unitizing ring</li> <li>• Fluoroelastomer O-rings standard</li> </ul>	-30°F (-34°C) to 400°F (204°C)	0.875 to 10.500 (22.2 to 266.7)	4,500 f/m (22.9 m/s)	±0.025 (0.38)	±0.020 (0.51)	Ambient
Non-Metallic Isolator (Glass-Filled PTFE)	Features	Materials	Temperature	Shaft Diameter in. (mm)	Surface Speed	Axial Motion in. (mm)	Misalign. & Runout in. @ f/m (mm@m/s)	Pressure
 <p><b>Standard</b></p>	<ul style="list-style-type: none"> <li>• Filled PTFE construction</li> <li>• Excellent chemical resistance</li> <li>• Meets NEMA MG 1-2003</li> <li>• Meets IEEE 841-2001 test standards</li> <li>• No arbor press required for installation</li> </ul>	<ul style="list-style-type: none"> <li>• FDA compliant blue glass filled PTFE</li> <li>• Fluoroelastomer O-rings standard</li> </ul>	-40°F (-40°C) to 400°F (204°C)	0.875 to 11.000 (22.2 to 279.4)	4,500 f/m (22.9 m/s)	±0.015 (0.38)	±0.020 (0.51)	Ambient
 <p><b>Small C/S</b></p>	<ul style="list-style-type: none"> <li>• Filled PTFE construction</li> <li>• Excellent chemical resistance</li> <li>• Meets NEMA MG 1-2003</li> <li>• Meets IEEE 841-2001 test standards</li> <li>• No arbor press required for installation</li> <li>• Fits in c/s as small as 0.188" (4.76mm)</li> </ul>	<ul style="list-style-type: none"> <li>• FDA compliant blue glass filled PTFE</li> <li>• Fluoroelastomer O-rings standard</li> </ul>	-40°F (-40°C) to 400°F (204°C)	0.875 to 11.000 (22.2 to 279.4)	4,500 f/m (22.9 m/s)	±0.015 (0.38)	±0.020 (0.51)	Ambient
 <p><b>Flangeless</b></p>	<ul style="list-style-type: none"> <li>• Filled PTFE construction</li> <li>• Excellent chemical resistance</li> <li>• Meets NEMA MG 1-2003</li> <li>• Meets IEEE 841-2001 test standards</li> <li>• No arbor press required for installation</li> <li>• Does not extend past face of housing</li> </ul>	<ul style="list-style-type: none"> <li>• FDA compliant blue glass filled PTFE</li> <li>• Fluoroelastomer O-rings standard</li> </ul>	-40°F (-40°C) to 400°F (204°C)	0.875 to 11.000 (22.2 to 279.4)	4,500 f/m (22.9 m/s)	±0.015 (0.38)	±0.020 (0.51)	Ambient
 <p><b>Grease Purgeable</b></p>	<ul style="list-style-type: none"> <li>• Filled PTFE construction</li> <li>• Excellent chemical resistance</li> <li>• Meets NEMA MG 1-2003</li> <li>• Meets IEEE 841-2001 test standards</li> <li>• No arbor press required for installation</li> <li>• Relief in seal allows regreasing with no disassembly of equipment</li> </ul>	<ul style="list-style-type: none"> <li>• FDA compliant blue glass filled PTFE</li> <li>• Fluoroelastomer O-rings standard</li> </ul>	-40°F (-40°C) to 400°F (204°C)	0.875 to 10.875 (22.2 to 276.2)	4,500 f/m (22.9 m/s)	±0.015 (0.38)	±0.020 (0.51)	5 psi
 <p><b>Split Pillow Block</b></p>	<ul style="list-style-type: none"> <li>• Filled PTFE construction</li> <li>• Excellent chemical resistance</li> <li>• Meets NEMA MG 1-2003</li> <li>• Meets IEEE 841-2001 test standards</li> <li>• No arbor press required for installation</li> <li>• Standard and custom design for split pillow blocks</li> </ul>	<ul style="list-style-type: none"> <li>• FDA compliant blue glass filled PTFE</li> <li>• Fluoroelastomer O-rings standard</li> </ul>	-40°F (-34°C) to 400°F (204°C)	0.875 to 11.000 (22.2 to 279.4)	4,500 f/m (22.9 m/s)	±0.015 (0.38)	±0.020 (0.51)	Ambient



<b>Non-Metallic Isolator (Glass-Filled PTFE)</b>	<b>Features</b>	<b>Materials</b>	<b>Temperature</b>	<b>Shaft Diameter in. (mm)</b>	<b>Surface Speed</b>	<b>Axial Motion in. (mm)</b>	<b>Misalign. &amp; Runout in. @ f/m (mm@m/s)</b>	<b>Pressure</b>
 <p><b>Step Shaft</b></p>	<ul style="list-style-type: none"> <li>Filled PTFE construction</li> <li>Excellent chemical resistance</li> <li>Meets NEMA MG 1-2003</li> <li>Meets IEEE 841-2001 test standards</li> <li>No arbor press required for installation</li> <li>Custom designed for individual stepshaft applications</li> </ul>	<ul style="list-style-type: none"> <li>FDA compliant blue glass filled PTFE</li> <li>Fluoroelastomer O-rings standard</li> </ul>	-30°F (-34°C) to 400°F (204°C)	0.875 to 10.500 (22.2 to 266.7)	12,000 f/m (60.9 m/s)	±0.025 (0.64)	±0.020 (0.51)	Ambient
 <p><b>Vertical</b></p>	<ul style="list-style-type: none"> <li>Filled PTFE construction</li> <li>Excellent chemical resistance</li> <li>Meets NEMA MG 1-2003</li> <li>Meets IEEE 841-2001 test standards</li> <li>No arbor press required for installation</li> <li>Two O. D. O-Rings for increased retention in the bore</li> <li>Vertical design for top applications only</li> </ul>	<ul style="list-style-type: none"> <li>FDA compliant blue glass filled PTFE</li> <li>Fluoroelastomer O-rings standard</li> </ul>	-30°F (-34°C) to 400°F (204°C)	0.875 to 5.500 (22.2 to 139.7)	12,000 f/m (60.9 m/s)	±0.015 (0.38)	±0.010 (0.25)	Ambient
<b>Non-Metallic Isolator (Graphite-Filled PTFE)</b>	<b>Features</b>	<b>Materials</b>	<b>Temperature</b>	<b>Shaft Diameter in. (mm)</b>	<b>Surface Speed</b>	<b>Axial Motion in. (mm)</b>	<b>Misalign. &amp; Runout in. @ f/m (mm@m/s)</b>	<b>Pressure</b>
 <p><b>Standard</b></p>	<ul style="list-style-type: none"> <li>Excellent chemical resistance</li> <li>Multi-position capability</li> <li>No arbor press required for installation</li> <li>Unique pumping/fanning action</li> </ul>	<ul style="list-style-type: none"> <li>Graphite-filled PTFE</li> <li>Fluoroelastomer O-rings standard</li> </ul>	-40°F (-40°C) to 400°F (204°C)	0.875 to 6.000 (22.2 to 152.4)	4,500 f/m (22.9 m/s)	±0.015 (0.38)	±0.015 (0.38)	Ambient
 <p><b>Standard C/S</b></p>	<ul style="list-style-type: none"> <li>Excellent chemical resistance</li> <li>Multi-position capability</li> <li>No arbor press required for installation</li> <li>Unique pumping/fanning action</li> <li>Designed to fit small c/s with no equipment modification</li> </ul>	<ul style="list-style-type: none"> <li>Graphite-filled PTFE</li> <li>Fluoroelastomer O-rings standard</li> </ul>	-40°F (-40°C) to 400°F (204°C)	0.875 to 10.500 (22.2 to 266.7)	4,500 f/m (22.9 m/s)	±0.015 (0.38)	±0.015 (0.38)	Ambient
 <p><b>Flangeless</b></p>	<ul style="list-style-type: none"> <li>Excellent chemical resistance</li> <li>Multi-position capability</li> <li>No arbor press required for installation</li> <li>Unique pumping/fanning action</li> <li>Does not extend past face of housing</li> </ul>	<ul style="list-style-type: none"> <li>Graphite-filled PTFE</li> <li>Fluoroelastomer O-rings standard</li> </ul>	-40°F (-40°C) to 400°F (204°C)	0.875 to 6.000 (22.2 to 152.4)	4,500 f/m (22.9 m/s)	±0.015 (0.38)	±0.015 (0.38)	Ambient

*For larger shaft diameters, please contact your Timken sales representative.*

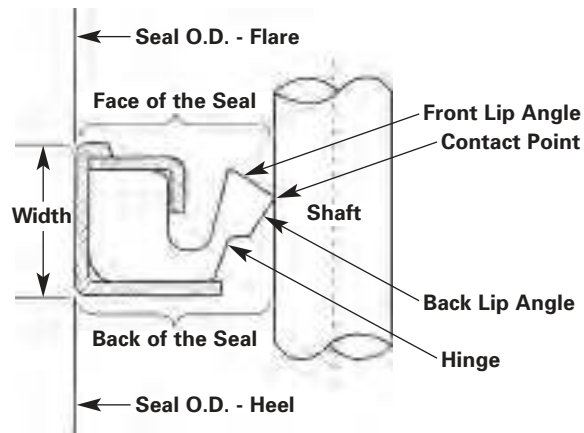

<b>Assembled Seal:</b>	Seal made up of a group of parts, including sealing surface(s), provisions for initial loading and a secondary sealing mechanism to accommodate radial movement required for installation and operation.	<b>Elastomer:</b>	Synthetic and natural materials that are able to be vulcanized and can be elongated at least twice their original length at room temperature, but are able to return to their approximate "normal" length when released. Common material used in the manufacture of seals.
<b>Axial Clearance:</b>	Gap between element heel and seal lip.	<b>End Play:</b>	Measurement of axial movement allowed, in reference to the shaft on which the seal lip comes into contact.
<b>Back Lip Angle:</b>	Angle seen from the back of the seal coinciding with the seal interface.	<b>Face Lip Angle:</b>	Angle seen from the face of the seal coinciding with the seal interface.
<b>Bearing Isolator:</b>	Product using labyrinth sealing methods and other techniques to provide high-performance sealing technology for demanding applications in operating environments with high levels of contamination.	<b>Fluid Side:</b>	1.) Refers to face of the seal when goal is to retain lubricant. 2.) Refers to the back of the seal when goal is to exclude contamination.
<b>Bonded Seal:</b>	Assembly in which the insert and/or spring is bonded to the elastomer sealing element.	<b>Garter Spring:</b>	Helically-coiled wire in the form of a ring that helps maintain a radial sealing force between the radial seal lip element and a shaft or bore. A close wound spring is used for tension and an open wound is used for compression.
<b>Contact Point:</b>	Interface where sealing element reacts with the shaft or bore housing.	<b>Heel:</b>	Part of lip seal case located tangent to the back of the seal.
<b>Contact Line Height:</b>	Axial distance from seal face to contact point.	<b>Hinge:</b>	Point at which the seal lip pivots around the seal assembly.
<b>Contact Width:</b>	Amount of area reacting dynamically in the axial direction.	<b>Housing Bore:</b>	Cylindrical surface that mates with the OD of a standard lip seal's outer case or an external lip seal's contact lip.
<b>Dynamic Runout:</b>	Amount by which a shaft, at the sealing surface, does not rotate around the true center. Measured by holding a dial indicator against the shaft surface while it is slowly rotated. The resulting measurement is called a total indicator reading, or TIR.	<b>Inclusion:</b>	Retaining lubricant by facing the seal in toward the lubricant.

<b>Inner Case:</b>	Rigid, cup-shaped component within a seal assembly that is used as a reinforcing member, shield, spring retainer and/or lip clamping device.	<b>Seal Outer Diameter (O.D.):</b>	External diameter of the lip seal assembly that interfaces with the housing bore diameter.
<b>Labyrinth Seal:</b>	Sealing product that uses an intricate pathway to exclude debris and retain lubrication.	<b>Shaft Eccentricity:</b>	Radial distance describing how much the geometric centerline of the shaft is displaced from the axis of the shaft rotation.
<b>Lip Diameter:</b>	Inner-most diameter of the seal lip, measured with the spring installed.	<b>Shaft Lead:</b>	Helical grooves in a shaft surface that are caused by relative axial movement of the grinding wheel to shaft.
<b>Lip Load:</b>	Radial force exerted by the seal lip geometry and spring loading. Expressed as force per unit of shaft circumference.	<b>“Slip-Stick”:</b>	Friction challenge caused by a sealing element that adheres to and rotates with the shaft surface until the elastic characteristics of the sealing element overcome the adhesive force, causing the seal lip to lose contact with the rotating surface long enough to cause leakage. Normally associated with non-lubricated and boundary-lubricated conditions, this cycle repeats itself again and again.
<b>Lip Seal:</b>	Elastomeric element that prevents leakage in dynamic and static applications through means of geometry and loading.	<b>Spring Groove:</b>	A semicircular depression in the head section of a seal that accommodates the garter spring.
<b>Lubricant Starvation:</b>	Inadequate lubrication at the seal interface which causes premature wear of seals.	<b>Spring Retaining Lip:</b>	Section of the primary lip that restricts axial movement of the extension spring from its proper position.
<b>Offset:</b>	Radial distance between the centerlines of the seal bore and the shaft rotation.	<b>Surface Finish:</b>	Quality, appearance and characteristics of a shaft surface due to processing such as grinding, burnishing, etc. [See SAE J488a (June 1963)]
<b>Outer Case:</b>	Rigid structure of lip-seal assembly that houses all components of the seal assembly.	<b>Unidirectional/Unirotational Seal:</b>	Type of seal designed for applications in which the shaft rotates in only one direction.
<b>Plunge Ground:</b>	Surface texture of a shaft or wear sleeve produced by using a grinding wheel perpendicular to the rotating shaft, without axial motion.	<b>Unitized Seal:</b>	Seal assembly in which all the parts are retained in a single package.
<b>Primary Lip:</b>	Elastomeric sealing element that rides against the rotating surface facing 1.) inward toward the lubricant for grease inclusion or 2.) outward from the lubricant for contaminant exclusion.	<b>Volume Swell:</b>	Increase in seal size due to the absorption of fluid by the elastomer. Usually leads to signs of incompatibility.
<b>Radial Lip Seal:</b>	Assembly containing an elastomeric element that prevents leakage in dynamic and static applications through means of geometry and loading.	<b>Wear Sleeve:</b>	Replaceable metal sleeve used in assemblies to prevent grooving from contamination at the seal-shaft interface.
<b>Radial Load:</b>	Radial force exerted by the seal lip geometry and spring loading. Expressed as a force per unit of shaft circumference.	<b>Weepage:</b>	Small amount of liquid leakage from a seal.
<b>Roughness:</b>	Anomalies in the surface texture of the shaft which result from the manufacturing process. [See SAE J448a (June 1963)]		
<b>Seal Case:</b>	Rigid member to which the elastomeric element is attached.		

**Oil Seals** Appendix A – Product Identification by Model Number

Model	Prefix	Seal Material	Description
21	25001	Timken N	SPLIT
	25002	SILICONE (SIL)	SPLIT
	25008	Timken V	SPLIT
	25018	Timken ES	SPLIT
23	25003	Timken N	SPLIT
	25004	SILICONE (SIL)	SPLIT
	25006	Timken V	SPLIT
	25010	Timken ES	SPLIT
24	25005	Timken N	SPLIT
	25029	Timken ES	SPLIT
	25030	Timken V	SPLIT
25	25056	PTFE	SOLID
	25058	PTFE	SPLIT
26	24600	Timken N	SOLID
	24602	Timken V	SOLID
	24610	Timken N	SPLIT
	24612	Timken V	SPLIT
	24626	Timken ES	SOLID
	24627	Timken ES	SPLIT
26E	24678	Timken N	EXTERNAL SPLIT
26HR	24656	Timken ES	HIGH RUNOUT, SPLIT
	24660	Timken N	HIGH RUNOUT
	24662	Timken V	HIGH RUNOUT
	24663	Timken N	HIGH RUNOUT, SPLIT
	24664	Timken ES	HIGH RUNOUT, SOLID
26NS	24650	Timken N	NO SPRING
	24652	Timken V	NO SPRING
26R1	24606	Timken V	SPLIT, DUAL LIP
	24608	Timken N	SPLIT, DUAL LIP
	24620	Timken N	DUAL LIP
	24622	Timken V	DUAL LIP
	24629	Timken ES	DUAL LIP
	24648	Timken ES	SPLIT, DUAL LIP
50	21020	Timken N	GARTER SPRING
51	21022	Timken N	METAL BUTTONS
	21486	Timken N	BRASS BUTTONS
	21619	Timken N	
53	21086	Timken N	STD
	21095	SILICONE (SIL)	STD
	21096	Timken ES	STD
	21699	Timken V	STD
53F1	22543	Timken V	STD
	22544	Timken ES	STD
	22987	Timken N	STD
53R2	22627	Timken N	STD
	22634	Timken ES	STD
	23708	Timken V	STD

Model	Prefix	Seal Material	Description
53T2	22897	Timken N	STD
	22903	Timken V	STD
54	21140	Timken N	STD
57	26056	Timken N	STD
	26057	Timken V	STD
	26058	Timken ES	STD
58	21003	CERAMIC	STD
59	24700	Timken N	STD
	24702	Timken V	STD
	24715	Timken ES	STD
59G1	24750	Timken N	GYLON EXCLUDER LIP
	24751	Timken ES	GYLON EXCLUDER LIP
	24752	Timken V	GYLON EXCLUDER LIP
P/S*1	24060	GYLON	GYLON LIP, FLUORO GSKT
	24062	GYLON	DBL TANDEM, GYLON LIP, FLUORO GSKT
	24063	GYLON	DBL OPPOSED, GYLON LIP, FLUORO GSKT
	24076 DT	FDA GYLON	DBL TANDEM, FDA GYLON LIP, FLUORO GSKT
P/S*1	24125 Std	FDA GYLON	FDA GYLON LIP, FLUORO GSKT
	24128 DO	FDA GYLON	DBL OPPOSED, FDA GYLON LIP, FLUORO GSKT
62	21702	PTFE	STD
63	21158	Timken N	STD
	21168	SILICONE (SIL)	STD
	21290	Timken ES	STD
	21695	Timken V	STD
63F1	23078	Timken N	FELT
63G1	23501	Timken ES	GYLON EXCLUDER LIP
	23502	Timken V	GYLON EXCLUDER LIP
	23503	Timken V	GYLON EXCLUDER LIP
63R1	23052	Timken ES	DUAL OPPOSED LIP - SINGLE SPRING
	23547	Timken N	DUAL OPPOSED LIP - SINGLE SPRING
	23548	Timken N	DUAL OPPOSED LIP - DUAL SPRING
63R2	23627	Timken V	DUAL OPPOSED LIP - DUAL SPRING
	23769	Timken ES	DUAL OPPOSED LIP - DUAL SPRING
63T2	23550	Timken N	DUAL TANDEM LIP - DUAL SPRING
	23552	Timken V	DUAL TANDEM LIP - DUAL SPRING

• Note: Please see Appendix B on page 30 for obsolete seal model to part number conversions.

Appendix A – Product Identification by Model Number **Oil Seals**

Model	Prefix	Seal Material	Description
63TB	23549	Timken N	DUAL TANDEM LIP - SINGLE SPRING
64	21238	Timken N	STD
	21243	SILICONE (SIL)	STD
	21247	Timken ES	STD
	21852	Timken V	STD
64G1	22503	Timken N	GYLON EXCLUDER LIP
	22504	Timken ES	GYLON EXCLUDER LIP
	22505	Timken V	GYLON EXCLUDER LIP
71	26001	NITRILE (NIT)	BONDED
76	26193	NITRILE (NIT)	BONDED
87	26080	Timken N	STD
	26081	Timken ES	STD
	26097	Timken V	STD
88	26088	Timken N	STD
	26588	Timken V	STD
88NS	26186	Timken ES	NO SPRING
	26188	Timken N	NO SPRING
91	27023	NITRILE (NIT)	BONDED
92	27063	NITRILE (NIT)	BONDED
94	27223	NITRILE (NIT)	BONDED
	27685	FLUROELASTOMER	BONDED
111	21011	Timken N	EXTERNAL
113	21012	Timken N	EXTERNAL
123	21016	Timken N	EXTERNAL

Model	Prefix	Seal Material	Description
143	21332	NITRILE (NIT)	MODEL 142 ELEMENT, FACE SEAL WITH HOSE CLAMP
	21333	NITRILE (NIT)	MODEL 145A2 ELEMENT, FACE SEAL WITH HOSE CLAMP
	21334	Timken	MODEL 145A2 ELEMENT, FACE SEAL WITH HOSE CLAMP
	21335	FLUROELASTOMER	MODEL 145A2 ELEMENT, FACE SEAL WITH HOSE CLAMP
	21339	Timken	MODEL 145A1 ELEMENT, FACE SEAL WITH HOSE CLAMP
	21340	NITRILE (NIT)	MODEL 145A1 ELEMENT, FACE SEAL WITH HOSE CLAMP
145A	21758	NITRILE (NIT)	SPECIAL
	21761	FLUROELASTOMER	SPECIAL
145A1	21700	NITRILE (NIT)	STD
	21712	Timken	STD
	21722	FLUROELASTOMER	STD
145A2	21750	NITRILE (NIT)	STD
	21751	FLUROELASTOMER	STD
	21754	Timken	STD
145L	21738	FLUROELASTOMER	SPECIAL
	21748	NITRILE (NIT)	SPECIAL
145S	21749	NITRILE (NIT)	SPECIAL

• Note: Please see Appendix B on page 30 for obsolete seal model to part number conversions.

**Oil Seals** Appendix A – Product Identification by Model Number

Model	Prefix	Description
<b>Non-Metallic Isolator (Graphite Filled PTFE)</b>	24801	STANDARD DESIGN, NO FLANGE
	24802	STANDARD DESIGN, 1/4" FLANGE
	24807	NARROW CROSS-SECTION DESIGN, 3/8" FLANGE
<b>Metallic Isolator</b>	29602	STANDARD CONFIGURATION - .325" FLANGE
	29604	STANDARD CONFIGURATION - .325" FLANGE - 316SS
	29606	NARROW CROSS SECTION - .375" FLANGE - 316SS
	29607	NARROW CROSS SECTION - .375" FLANGE
	29608	NARROW CROSS SECTION - .250" FLANGE
	29609	NO FLANGE - SPECIAL .375" WIDTH
	29610	29602 VERSION - FLANGE DIAMETER 0.020" OVER BORE DIAMETER
	29611	NO FLANGE - SPECIAL .375" WIDTH - 316SS
	29612	NO FLANGE - 316SS
	29616	SPLIT PILLOW BLOCK
	29619	NO FLANGE
	29620	VERTICAL 2 O-RINGS ON O.D.
	29621	VERTICAL 1 O-RING ON O.D.

Model	Prefix	Description
<b>Metallic Isolator (Microcellular)</b>	29102	STANDARD CONFIGURATION - .325" FLANGE
	29106	STANDARD - 316SS
	29119	NO FLANGE
<b>Non-Metallic Isolator (Glass Filled PTFE)</b>	29500	1/4" FLANGE - 3/4" WIDE FOR CROSS SECTION 1/2" OR MORE
	29502	3/8" FLANGE - ONE O-RING ON O.D. - 3/4" WIDE
	29507	3/8" FLANGE - ONE O-RING ON O.D. - 5/8" WIDE
	29516	SPLIT PILLOW BLOCK DESIGN
	29518	GREASE PURGE DESIGN
	29519	STANDARD NO FLANGE DESIGN
	29520	STD VERTICAL DESIGN - ONE O-RING ON O.D.
	29521	STANDARD VERTICAL DESIGN - TWO O-RINGS ON O.D.

• Note: Please see Appendix B on page 30 for obsolete seal model to part number conversions.



Appendix A – Product Identification by Model Number **Oil Seals**

Prefix	Model	Seal Material	Description
21003	58	THERMO-CERAM	STANDARD CONFIGURATION
21011	111	Timken N	EXTERNAL
21012	113	Timken N	EXTERNAL
21016	123	Timken NE	EXTERNAL
21020	50	Timken N	GARTER SPRING
21022	51	Timken N	METAL BUTTONS
21086	53	Timken N	STANDARD CONFIGURATION
21095	53	SILICONE (VMQ)	STANDARD CONFIGURATION
21096	53	Timken ES	STANDARD CONFIGURATION
21140	54	Timken N	STANDARD CONFIGURATION
21158	63	Timken N	STANDARD CONFIGURATION
21168	63	SILICONE (VMQ)	STANDARD CONFIGURATION
21238	64	Timken N	STANDARD CONFIGURATION
21243	64	SILICONE (VMQ)	STANDARD CONFIGURATION
21247	64	Timken ES	STANDARD CONFIGURATION
21290	63	Timken ES	STANDARD CONFIGURATION
21332	143	Timken N	MODEL 142 ELEMENT, FACE SEAL WITH HOSE CLAMP
21333	143	Timken N	MODEL 145A2 ELEMENT, FACE SEAL WITH HOSE CLAMP
21334	143	Timken ES	MODEL 145A2 ELEMENT, FACE SEAL WITH HOSE CLAMP
21335	143	Timken VM	ODEL 145A2 ELEMENT, FACE SEAL WITH HOSE CLAMP
21339	143	Timken ES	MODEL 145A1 ELEMENT, FACE SEAL WITH HOSE CLAMP
21340	143	Timken N	MODEL 145A1 ELEMENT, FACE SEAL WITH HOSE CLAMP
21486	51	Timken N	BRASS BUTTONS
21619	51	Timken N	STANDARD CONFIGURATION
21695	63	Timken V	STANDARD CONFIGURATION
21699	53	Timken V	STANDARD CONFIGURATION
21700	145A1	Timken N	STANDARD CONFIGURATION
21702	62	PTFE	STANDARD CONFIGURATION

Prefix	Model	Seal Material	Description
21712	145A1	Timken ES	STANDARD CONFIGURATION
21722	145A1	Timken V	STANDARD CONFIGURATION
21738	145L	FLUOROELASTOMER	SPECIAL
21748	145L	NITRILE (NBR)	SPECIAL
21749	145S	NITRILE (NBR)	SPECIAL
21750	145A2	Timken N	STANDARD CONFIGURATION
21751	145A2	Timken V	STANDARD CONFIGURATION
21754	145A2	Timken ES	STANDARD CONFIGURATION
21758	145A	Timken N	SPECIAL
21761	145A	FLUOROELASTOMER	SPECIAL
21852	64	Timken V	STANDARD CONFIGURATION
22503	64G1	Timken N	GYLON EXCLUDER LIP
22504	64G1	Timken ES	GYLON EXCLUDER LIP
22505	64G1	Timken V	GYLON EXCLUDER LIP
22543	53F1	Timken V	STANDARD CONFIGURATION
22544	53F1	Timken ES	STANDARD CONFIGURATION
22627	53R2	Timken N	STANDARD CONFIGURATION
22634	53R2	Timken ES	STANDARD CONFIGURATION
22897	53T2	Timken N	STANDARD CONFIGURATION
22903	53T2	Timken V	STANDARD CONFIGURATION
22987	53F1	Timken N	STANDARD CONFIGURATION
23052	63R1	Timken ES	DUAL OPPOSED LIP - SINGLE SPRING
23078	63F1	Timken N	FELT
23501	63G1	Timken ES	GYLON EXCLUDER LIP
23502	63G1	Timken V	GYLON EXCLUDER LIP
23503	63G1	Timken V	GYLON EXCLUDER LIP
23547	63R1	Timken N	DUAL OPPOSED LIP - SINGLE SPRING
23548	63R2	Timken N	DUAL OPPOSED LIP - DUAL SPRING
23549	63TB	Timken N	DUAL TANDEM LIP - SINGLE SPRING
23550	63T2	Timken N	DUAL TANDEM LIP - DUAL SPRING
23552	63T2	Timken V	DUAL TANDEM LIP - DUAL SPRING
23627	63R2	Timken V	DUAL OPPOSED LIP - DUAL SPRING

• Note: Please see Appendix B on page 30 for obsolete seal model to part number conversions.

**Oil Seals** Appendix A – Product Identification by Model Number

Model	Prefix	Seal Material	Description
23708	53R2	Timken V	STANDARD CONFIGURATION
23769	63R2	Timken E	SDUAL OPPOSED LIP - DUAL SPRING
24060	PS I (61)	GYLON	GYLON LIP, FLUORO GASKET
24062	PS I (61)	GYLON	DOUBLE TANDEM, GYLON LIP, FLUORO GASKET
24063	PS I (61)	GYLON	DOUBLE OPPOSED, GYLON LIP, FLUORO GASKET
24064	PS I (61)	GYLON	GYLON LIP, REVERSE LIP, FLUORO GASKET
24125	PS I (61)	GYLON	GYLON LIP - FDA , GYLON GASKET
24600	26	Timken N	SOLID
24602	26	Timken V	SOLID
24606	26R1	Timken V	SPLIT, DUAL LIP
24608	26R1	Timken N	SPLIT, DUAL LIP
24610	26	Timken N	SPLIT
24612	26	Timken V	SPLIT
24620	26R1	Timken N	DUAL LIP
24622	26R1	Timken V	DUAL LIP
24626	26	Timken ES	SOLID
24627	26	Timken ES	SPLIT
24629	26R1	Timken ES	DUAL LIP
24648	26R1	Timken ES	SPLIT, DUAL LIP
24650	26NS	Timken N	NO SPRING
24652	26NS	Timken V	NO SPRING
24656	26HR	Timken ES	HIGH RUNOUT, SPLIT
24660	26HR	Timken N	HIGH RUNOUT
24662	26HR	Timken V	HIGH RUNOUT
24663	26HR	Timken N	HIGH RUNOUT, SPLIT
24664	26HR	Timken ES	HIGH RUNOUT, SOLID
24678	26E	Timken N	EXTERNAL SPLIT
24700	59	Timken N	STANDARD CONFIGURATION
24702	59	Timken V	STANDARD CONFIGURATION
24715	59	Timken ES	STANDARD CONFIGURATION
24750	59G1	Timken N	GYLON EXCLUDER LIP
24751	59G1	Timken ES	GYLON EXCLUDER LIP

Model	Prefix	Seal Material	Description
24752	59G1	Timken V	GYLON EXCLUDER LIP
25001	21	Timken N	SPLIT
25002	21	SILICONE (VMQ)	SPLIT
25003	23	Timken N	SPLIT
25004	23	SILICONE (VMQ)	SPLIT
25005	24	Timken N	SPLIT
25006	23	Timken V	SPLIT
25008	21	Timken V	SPLIT
25010	23	Timken ES	SPLIT
25018	21	Timken ES	SPLIT
25029	24	Timken ES	SPLIT
25030	24	Timken V	SPLIT
25056	25	PTFE	SOLID
25058	25	PTFE	SPLIT
26001	71	NITRILE (NBR)	BONDED
26056	57	Timken N	STANDARD CONFIGURATION
26057	57	Timken V	STANDARD CONFIGURATION
26058	57	Timken ES	STANDARD CONFIGURATION
26080	87	Timken N	STANDARD CONFIGURATION
26081	87	Timken ES	STANDARD CONFIGURATION
26088	88	Timken N	STANDARD CONFIGURATION
26097	87	Timken V	STANDARD CONFIGURATION
26186	88NS	Timken ES	NO SPRING
26188	88NS	Timken N	NO SPRING
26193	76	NITRILE (NBR)	BONDED
26588	88	Timken V	STANDARD CONFIGURATION
27023	91	NITRILE (NBR)	BONDED
27063	92	NITRILE (NBR)	BONDED
27223	94	NITRILE (NBR)	BONDED
27685	94	FLUOROELASTOMER	BONDED

• Note: Please see Appendix B on page 30 for obsolete seal model to part number conversions.

**Appendix B – Obsolete Oil Seals (Model Number to Part Number Conversions) Oil Seals**

Model	Prefix	Seal Material	Description
21	25051	Timken N	2 BUTT CUTS @ 180 DEG APART
	25068	SILICONE (SIL)	2 BUTT CUTS @ 180 DEG APART
	25089	Timken N	RIGHT HAND BEVEL CUT
	25254	Timken N	1/8" THK GASKETS
	25255	Timken N	3/16" THK GASKETS
23	25019	Timken ES	GREEN O.D. SEALANT
	25020	Timken ES	SOLID, GREEN O.D. SEALANT
	25025	Timken N	316 STAINLESS STEEL SPRING-SPLIT
	25036	Timken N	ISO TOLERANCE STANDARDS
	25044	Timken V	LEFT HAND BEVEL CUT
	25075	Timken N	2 BUTT CUTS, 1/3 & 2/3 SECTIONS
	25077	Timken N	SOLID, SPECIAL
	25080	SILICONE (SIL)	2 BUTT CUTS @ 180 DEG APART
	25084	SILICONE (SIL)	SOLID
	25086	Timken N	NOTCHES
	25090	SILICONE (SIL)	RIGHT HAND CUT
	25109	Timken N	EXTERNAL CONSTRUCTION
	25114	BUTYLSPLIT	
	25131	Timken N	2 BUTT CUTS, 3/16" GASKET
	25152	Timken N	SPECIAL
	25153	SILICONE (SIL)	SOLID, W/ GARTER SPRING
	25156	Timken N	SOLID, SPECIAL
	25157	SILICONE (SIL)	SEMI-FINISHED, UNCUT
	25168	Timken ES	NOTCHES
	25204	Timken N	1/8" THK GASKETS
	25205	Timken N	3/16" THK GASKETS
	25206	Timken N	1/4" THK GASKETS
	25229	SILICONE (SIL)	ENCAP SPRING
	25230	SILICONE (SIL)	1/8" THK GASKETS
	25270	Timken V	ENCAP SPRING
	25278	Timken N	ENCAP SPRING, SPECIAL
	25279	Timken N	2 LEFT HAND BEVEL CUTS, CUT 1/3 & 2/3 SECT
	25280	Timken N	RIGHT HAND BEVEL CUTS,CUT 1/3 & 2/3 SECT
	25281	Timken N	SOLID, SPECIAL
	25284	FDA SILICONE (SIL)	ENCAP SPRING, FDA
25285	FDA SILICONE (SIL)	ENCAP SPRING, FDA - SOLID	
25305	Timken V	NO SPRING	
25	25074	PTFE	302 STAINLESS STEEL SPRING SOLID

Model	Prefix	Seal Material	Description
26	24615	Timken N	LOW TEMP. Timken N
	24617	Timken V	SPLIT, NO SPRING
	24623	Timken V	SOLID, NO FABRIC
	24624	Timken N	SPLIT, NO FABRIC
	24646	Timken V	SPLIT, NO FABRIC
	24653	Timken N	NO FABRIC IN HEEL
	24677	Timken ES	SOLID, NO FABRIC
	24682	Timken V	HIGH PRESSURE
	24698	Timken N	SPLIT TO ISO TOLERANCE STD
	26E	24640	Timken N
26HP	24680	Timken N	HIGH PRESSURE
51	21021	Timken N	NO SPRING
53	21060	Timken N	ISO TOLERANCE STD
	21082	Timken ES	NO OD SEALANT, STAMP Timken ES
	21083	Timken ES	METAL BUTTONS, ISO STD
	21084	Timken ES	ISO TOLERANCE STD
	21092	Timken N	
	21094	Timken ES	
	21097	Timken ES	
	21099	Timken ES	GREEN O.D. SEALANT
	21100	SILICONE (SIL)	
	21101	FDA SILICONE (SIL)	FDA SILICONE
	21366	Timken N	LOW TEMP NTRILE
	21381	BUTYL	
	21392	BUTYL	
	21446	SILICONE (SIL)	
	21657	Timken N	O.D. SEALANT
21682	Timken V	GREEN Timken V	
21692	Timken V	O.D. SEALANT	
21706	Timken N	DRAW HOLES	
21733	Timken V	NO SPRING	
21836	Timken N	LOW TEMP	
21882	Timken V		
53F1	22992	Timken N	
	22995	Timken ES	
	22996	Timken V	
	22998	SILICONE (SIL)	
53R2	22628	Timken N	
	22629	FDA SILICONE (SIL)	
	23703	SILICONE (SIL)	

**Oil Seals** Appendix B – Obsolete Oil Seals (Model Number to Part Number Conversions)

Model	Prefix	Seal Material	Description
53T2	22898	Timken N	
	22899	FDA SILICONE (SIL)	
	22905	Timken ES	
	23051	SILICONE (SIL)	
53TB	22807	Timken N	
54	21883	Timken N	
57	26059	SILICONE (SIL)	
	26061	SILICONE (SIL)	MODIFIED DUST LIP
58	21008	CERAMIC	
	21009	CARBON FLMNT	
59	24705	Timken V	
	24710	Timken N	SPECIAL
	24711	Timken N	
	24718	Timken ES	STAMP "Timken ES" ON CASE
	24719	Timken N	NO SPRING METAL BUTTONS
	24735	Timken ES	SPECIAL EXCLUDER LIP
	24737	Timken ES	NO SPRING
	24738	Timken ES	BLUE COATING ON INNER SHELL
	24740	Timken V	ELEMENT ONLY-SPLIT
	24741	Timken V	ELEMENT ONLY-SPLIT- NO SPRING
	24744	Timken N	5/16" METAL BUTTONS
	24755	Timken N	SPECIAL WIDTH TOLERANCE TO BE +/- .008"
	24757	Timken V	24769Timken ES. 156" METAL BUTTONS
	24772	Timken ES	.197" (5mm) METAL BUTTONS
24773	Timken N		
59G1	24734	Timken V	GYLON EXCLUDER LIP
	24753	Timken ES	GYLON ENHANCED, METAL BUTTONS
59R1	24720	Timken N	
	24726	Timken N	
61 P/S®	124057	PTFE	PTFE LIP , Timken N GSKT
	24059	FDA GYLON	DBL TANDEM, FDA WHITE GYLON LIP, FDA WHITE GYLON GSKT
	24061	FDA GYLON	FDA WHITE GYLON LIP, FLUORO GSKT
	24070	GYLON	REDUCED LOAD , BLACK GYLON LIP , FLUORO GSKT
	24072	FDA GYLON	DBL OPPOSED, FDA

Model	Prefix	Seal Material	Description
	24073	FDA GYLON	WHITE GYLON LIP , FDA FLUORO GSKT
	24105	GYLON	FDA WHITE GYLON LIP ONLY FLUORO LIP ONLY
	24108	PTFE	PTFE LIP, FLUORO GSKT, 304SS INNER CASE
	24130	FDA GYLON	REVERSED LIP, FDA WHITE GYLON LIP, FDA FLUORO GSKT
62	21154	PTFE	WHITE PTFE, STAINLESS STEEL SPRING
	21155	PTFE	WHITE PTFE
	21653	PTFE	WHITE PTFE, STAINLESS STEEL SPRING
	21777	PTFE	STAINLESS STEEL SPRING
	21844	PTFE	STAINLESS STEEL SPRING
	21867	PTFE	NO SPRING
	21954	PTFE	NO SPRING
63	21162	Timken N	
	21172	FDA SILICONE (SIL)	FDA APPROVED SILICONE
	21175	FDA SILICONE (SIL)	FDA APPROVED SILICONE
	21186	SILICONE (SIL)	
	21295	Timken ES	
	21296	Timken ES	
	21374	BUTYL	
	21466	Timken N	SPECIAL
	21474	SILICONE (SIL)	NO SPRING
	21480	SILICONE (SIL)	
	21688	Timken N	DRAW HOLES
	21690	Timken V	GREEN Timken V
	21707	Timken N	DRAW HOLES
	21760	Timken N	DRAW HOLES, O.D. SEALANT
21890	Timken N		
21933	SILICONE (SIL)	O.D. SEALANT	
63F1	23670	Timken N	
63G1	23501	Timken ES	GYLON EXCLUDER LIP
	23502	Timken V	GYLON EXCLUDER LIP
	23503	Timken V	GYLON EXCLUDER LIP
63R	23169	Timken V	NO SPRING
63R1	23605	Timken N	
63R2	23046	Timken N	
	23631	Timken V	
	23689	Timken N	
	23747	Timken N	SPECIAL

Appendix B – Obsolete Oil Seals (Model Number to Part Number Conversions) **Oil Seals**

Model	Prefix	Seal Material	Description
63T2	23713	FDA SILICONE (SIL)	FDA SILICONE
	23748	Timken V	
63TB	23690	Timken N	
64	21223	Timken N	5/16" METAL BUTTONS
	21241	Timken ES	BLUE COATING ON INNER RING
	21246	Timken N	STAINLESS STEEL SPRING
	21254	Timken N	METAL BUTTONS
	21255	Timken ES	STAMP "Timken ES" ON CASE
	21256	Timken N	NO SPRINGS
	21261	Timken N	STAINLESS STEEL GARTER SPRING
	21385	SILICONE (SIL)	NO SPRING
	21398	Timken V	ZINC PLATED FILLER RING
	21855	Timken V	METAL BUTTONS
	21859	Timken V	
	21886	SILICONE (SIL)	METAL BUTTONS
	21997	SILICONE (SIL)	
	66	21519	Timken V
21913		Timken N	STAINLESS STEEL SPRING
21930		Timken N	STAINLESS STEEL SPRING
67	21632	Timken N	STAINLESS STEEL SPRING
	21664	Timken N	O.D. SEALANT
	21694	Timken N	NO SPRING
	21763	SILICONE (SIL)	STAINLESS STEEL SPRING
	21800	Timken N	STAINLESS STEEL SPRING
	21801	Timken N	NO SPRING
	21818	Timken ES	
	21819	Timken ES	STAINLESS STEEL SPRING
	21827	Timken ES	
	21944	Timken N	

Model	Prefix	Seal Material	Description
67R1	23048	Timken N	
67T2	23621	Timken N	
68	21910	Timken N	STAINLESS STEEL SPRING
68R2	23724	Timken N	STAINLESS STEEL SPRING
	23727	Timken N	
	23736	Timken N	STAINLESS STEEL SPRING; 9010 FILLER RING
87	26078	Timken ES	NO BUTTONS, .093" THK METAL INSERT
88	26079	Timken N	STAINLESS STEEL SPRING
	26185	Timken ES	NO BUTTONS
88NS	26589	Timken V	NO SPRING
113	21503	Timken N	
	21927	Timken N	
123	21814	Timken ES	
142	21485	Timken	MOLDED LIP ONLY, BUTT JOINT
145A	221757	BUTYL	

## Oil Seals Appendix C – Compound Compatibility Chart

Compound Code	Timken Black NBR			Timken Blue HNBR			Timken Green FKM			Silicone VMQ			Gylon® PTFE		
	Rating	°F	°C	Rating	°F	°C	Rating	°F	°C	Rating	°F	°C	Rating	°F	°C
Acetamide (Acryimide)	1	70	21	1	70	21	2	140	60	3	70	21	1	300	149
Acetone	4	70	21	4	70	21	4	70	21	3	70	21	1	200	93
Acetyl Chloride	4	70	21	4	70	21	2	70	21	3	70	21	1	200	93
Acetylene Gas	1	200	93	1	ND	ND	1	200	93	2	70	21	1	200	93
Aluminum Chloride	1	160	71	1	70	21	1	212	100	2	70	21	1	boiling	boiling
Aluminum Phosphate	1	70	21	1	70	21	1	70	21	1	70	21	1	70	21
Aluminum Sulphate	1	160	71	1	ND	ND	1	140	60	1	70	21	1	200	93
Ammonium Chloride	2	200	93	1	70	21	1	212	100	3	70	21	1	250	121
Ammonium Hydroxide	4	140	60	4	ND	ND	2	70	21	1	70	21	1	300	149
Ammonium Nitrate	1	200	93	1	70	21	1	176	80	3	70	21	1	200	93
Ammonium Nitrite	1	70	21	1	70	21	1	70	21	2	70	21	1	70	21
Ammonium Phosphate	1	200	93	1	ND	ND	1	176	80	1	70	21	1	70	21
Ammonium Sulfate	1	200	93	1	ND	ND	1	176	80	1	70	21	1	200	93
Amyl Borate	2	100	38	1	70	21	1	70	21	4	70	21	1	70	21
Amyl Chloronaphthalene	4	80	27	4	70	21	1	140	60	4	70	21	1	70	21
Amyl Naphthalene	4	70	21	4	70	21	1	70	21	4	70	21	1	70	21
Arsenic Acid	1	140	60	1	70	21	1	140	60	1	70	21	1	200	93
Asphalt Emulsion	2	70	21	ND	ND	ND	1	400	204	4	70	21	1	180	82
Asphalt Topping	2	150	66	2	ND	ND	1	212	100	4	70	21	1	180	82
ATF-TYPE A	1	70	21	1	70	21	1	70	21	1	70	21	1	450	232
Automotive Brake Fluid	3	70	21	ND	ND	ND	4	70	21	1	70	21	1	70	21
Automotive Gasoline	1	250	121	ND	ND	ND	1	70	21	4	70	21	ND	ND	ND
Benzene (Gasoline)	1	250	121	1	ND	ND	1	100	38	4	70	21	1	300	149
Benzoic Acid	4	70	21	3	ND	ND	1	176	80	4	70	21	1	300	149
Benzoyl Chloride	4	70	21	4	ND	ND	4	70	21	4	70	21	1	70	21
Benzyl Alcohol	4	70	21	4	ND	ND	1	140	60	2	ND	ND	1	400	204
Benzyl Benzoate	4	70	21	4	ND	ND	1	70	21	1	ND	ND	1	70	21
Benzyl Chloride	4	70	21	4	ND	ND	1	200	93	4	70	21	1	387	197
Biphenyl	4	70	21	4	70	21	1	300	149	4	70	21	1	300	149
Black Liquor	1	140	60	ND	ND	ND	1	212	100	1	70	21	1	70	21
Black Liquor Waste	1	70	21	ND	ND	ND	1	70	21	ND	ND	ND	1	70	21
Black Sulfate Liquor	2	200	93	ND	ND	ND	1	176	80	2	70	21	1	70	21
Blast Furnace Gas	4	70	21	4	70	21	1	70	21	1	250	121	1	70	21
Boric Acid	1	140	60	1	70	21	1	176	80	1	70	21	1	300	149
Bromine Anhydrous Gas	4	70	21	4	ND	ND	1	70	21	3	70	21	1	300	149
Bromobenzene	4	70	21	4	70	21	1	70	21	4	70	21	1	122	50
Butadien (Monomer)	4	140	60	4	ND	ND	2	250	121	4	70	21	1	300	149
Butane	1	200	93	1	70	21	1	176	80	4	70	21	1	300	149
Butyl Acetate	4	70	21	4	70	21	4	70	21	4	70	21	1	300	149
N-Butyl Benzoate	4	70	21	4	70	21	1	70	21	1	ND	ND	1	122	50
Butyl Carbitol	4	70	21	4	70	21	3	70	21	4	70	21	1	70	21
Butyl Oleate	4	70	21	4	70	21	3	70	21	2	70	21	1	70	21
Butyl Stearate	2	104	40	2	70	21	1	104	40	ND	ND	ND	1	70	21
Butylene	1	250	121	4	70	21	1	140	60	4	70	21	1	200	93
Calcium Bisulfate	1	70	21	ND	ND	ND	1	70	21	3	70	21	1	70	21
Calcium Bisulfide	1	70	21	ND	ND	ND	1	140	60	3	70	21	1	70	21

Rating Key: 1 = Excellent compatibility up to given temperature  
2 = Good compatibility up to given temperature

3 = Limited compatibility up to given temperature  
4 = Poor compatibility up to given temperature



Appendix C – Compound Compatibility Chart **Oil Seals**

Compound Code	Timken Black NBR			Timken Blue HNBR			Timken Green FKM			Silicone VMQ			Gylon® PTFE		
	Rating	°F	°C	Rating	°F	°C	Rating	°F	°C	Rating	°F	°C	Rating	°F	°C
Calcium Bisulfite	1	104	40	1	70	21	1	176	80	1	70	21	1	200	93
Calcium Hydroxide	1	140	60	1	70	21	1	212	100	1	70	21	1	122	50
Calcium Hypochlorite	3	70	21	2	70	21	1	70	21	2	70	21	1	300	149
Calcium Nitrate	1	176	80	1	70	21	1	212	100	2	70	21	1	200	93
Calcium Sulfide	1	140	60	1	70	21	1	212	100	2	70	21	1	300	149
Carbamate	3	70	21	3	ND	ND	1	70	21	1	ND	ND	1	70	21
Carbolic Acid	4	70	21	4	70	21	1	140	60	4	70	21	1	70	21
Carbon Dioxide	1	160	71	1	70	21	2	212	100	2	70	21	1	300	149
Carbon Monoxide	1	140	60	1	70	21	1	212	100	1	140	60	1	300	149
Carbon Tetrachloride	4	70	21	2	70	21	1	75	24	4	70	21	1	200	93
Chlorine Dioxide	4	70	21	4	70	21	1	70	21	3	70	21	1	70	21
Chlorobenzene	4	70	21	4	70	21	1	200	93	4	70	21	1	300	149
Chlorotoluene	4	70	21	4	70	21	1	200	93	4	70	21	1	387	197
Chrome Plating Solutions	4	70	21	4	70	21	1	70	21	2	70	21	1	70	21
Chromic Acid	4	70	21	4	70	21	1	70	21	2	70	21	2	248	120
Cobalt Chloride	1	70	21	1	70	21	1	70	21	2	70	21	ND	ND	ND
Copper Chloride	1	176	80	1	70	21	1	212	100	1	70	21	11	50	66
Copper Cyanide	1	boiling	boiling	1	70	21	1	boiling	boiling	1	70	21	1	300	149
Copper Plating Solution	1	140	60	ND	ND	ND	1	140	60	4	70	21	1	70	21
Copper Sulfate	1	176	80	1	70	21	1	140	60	1	70	21	1	200	93
Creosote	2	70	21	2	ND	ND	1	212	100	4	70	21	1	70	21
Cresylic Acid	4	70	21	1	70	21	1	158	70	4	70	21	1	200	93
Cumene	4	70	21	4	70	21	1	200	93	4	70	21	3	122	50
Cyclohexane	1	250	121	1	70	21	1	200	93	4	70	21	1	300	149
Cyclohexanol	1	70	21	1	70	21	1	104	40	4	70	21	1	200	93
Degreasing Fluid	4	70	21	ND	ND	ND	1	70	21	ND	ND	ND	1	70	21
Denatured Alcohol	1	70	21	1	70	21	1	70	21	1	212	100	1	70	21
Detergent Solutions	1	200	93	1	70	21	1	212	100	1	ND	ND	1	300	149
Developing Fluids	1	70	21	1	70	21	1	70	21	1	70	21	1	300	149
Dibromoethyl Benzene	4	70	21	4	70	21	1	70	21	4	70	21	ND	ND	ND
0-Dichlorobenzene	4	70	21	4	70	21	1	158	70	4	70	21	1	125	52
Diesel Oil	1	250	121		170	21	1	200	93	4	70	21	1	300	149
Diethylamine	3	140	60	3	70	21	4	140	60	2	70	21	1	300	149
Diethylbenzene	4	70	21	4	70	21	1	200	93	4	70	21	1	122	50
Diethylene Glycol	1	200	93	1	ND	ND	1	140	60	2	70	21	1	125	52
Diisooctyl Sebacate	3	70	21	4	70	21	2	70	21	3	70	21	ND	ND	ND
Diisopropyl Benzene	4	70	21	4	70	21	1	200	93	4	70	21	1	70	21
Dimethylether	1	70	21	1	70	21	1	70	21	1	70	21	1	70	21
Dimethylphthalate	4	70	21	4	70	21	1	70	21	2	70	21	1	392	200
Dipentene	2	200	93	2	70	21	1	70	21	4	70	21	1	70	21
Diphenyl	4	70	21	4	70	21	1	300	149	4	70	21	1	300	149
Diphenyl Oxides	4	70	21	4	70	21	1	140	60	3	70	21	1	70	21
Dry Cleaning Fluids	3	70	21	3	70	21	1	70	21	4	70	21	1	70	21
Ethane	1	140	60	1	70	21	1	140	60	4	70	21	1	70	21
Ethanol	1	140	60	1	70	21	4	104	40	1	70	21	1	392	200
Ethyl Alcohol	1	140	60	1	70	21	1	70	21	2	70	21	1	392	200

Rating Key: 1 = Excellent compatibility up to given temperature      3 = Limited compatibility up to given temperature  
 2 = Good compatibility up to given temperature                      4 = Poor compatibility up to given temperature

## Oil Seals Appendix C – Compound Compatibility Chart

Compound Code	Timken Black NBR			Timken Blue HNBR			Timken Green FKM			Silicone VMQ			Gylon® PTFE		
	Rating	°F	°C	Rating	°F	°C	Rating	°F	°C	Rating	°F	°C	Rating	°F	°C
Ethyl Chloride	1	140	60	1	70	21	1	140	60	4	70	21	1	125	52
Ethyl Formate	4	70	21	4	70	21	1	70	21	ND	ND	ND	1	70	21
Ethyl Oxalate	4	70	21	4	70	21	1	70	21	4	70	21	1	70	21
Ethyl Silicate	1	70	21	1	70	21	1	70	21	ND	ND	ND	1	70	21
Ethylene	1	200	93	1	70	21	1	70	21	4	70	21	1	70	21
Ethylene Chlorohydrin	4	70	21	4	70	21	1	70	21	3	70	21	1	300	149
Ethylene Diamine	1	80	27	1	70	21	4	70	21	1	70	21	1	242	117
Ethylene Dichloride	4	70	21	4	70	21	1	200	93	4	70	21	1	300	149
Ethylene Glycol	1	212	100	1	70	21	1	250	121	1	70	21	1	300	149
Ethylene Trichloride	4	70	21	4	70	21	1	70	21	4	70	21	1	70	21
Ferric Chloride	1	150	66	1	70	21	1	176	80	2	70	21	1	300	149
Ferric Nitrate	1	140	60	1	70	21	1	212	100	3	70	21	1	300	149
Ferric Sulfate	1	140	60	1	70	21	1	176	80	2	70	21	1	300	149
Formic Acid	4	70	21	2	140	60	3	140	60	3	70	21	1	boiling	boiling
Freon 12	1	250	121	1	70	21	2	75	24	4	70	21	1	70	21
Freon 22	4	70	21	4	70	21	4	70	21	4	70	21	1	300	149
Fuel Oil	1	250	121	1	70	21	1	200	93	4	70	21	1	300	149
Fumaric Acid	1	70	21	1	70	21	1	70	21	2	70	21	1	70	21
Fyrquel	4	70	21	4	70	21	1	212	100	1	70	21	1	70	21
Gear Oil Super	1	212	100	1	70	21	1	350	177	1	70	21	ND	ND	ND
Grease	1	100	38	1	70	21	1	140	60	4	70	21	1	70	21
Hydraulic Oil	1	250	121	1	70	21	1	70	21	3	70	21	1	70	21
Hydrobromic Acid	4	140	60	4	70	21	1	140	60	4	70	21	1	212	100
Hydrocyanic Acid	2	140	60	2	70	21	1	140	60	3	70	21	1	300	149
Hydrofluosilicic Acid	1	70	21	1	70	21	1	70	21	4	70	21	1	2009	3
Hydrogen Gas	1	200	93	1	70	21	1	176	80	3	140	60	1	300	149
Hypoid Lubes	2	70	21	2	70	21	1	300	149	4	70	21	ND	ND	ND
Isobutyl Alcohol	2	80	27	2	70	21	1	75	24	1	70	21	1	200	93
Isooctane	1	250	121	1	70	21	1	70	21	4	70	21	1	300	149
Isopropyl Alcohol	1	70	21	2	70	21	1	170	77	1	70	21	1	300	149
Kerosene	1	250	121	1	70	21	1	158	70	4	70	21	1	300	149
Ketones	4	70	21	4	70	21	4	70	21	4	70	21	1	300	149
Lacquers	4	70	21	4	70	21	4	70	21	4	70	21	1	70	21
Lacquer Solvents	4	70	21	4	70	21	4	70	21	4	70	21	1	70	21
Lead Nitrate	1	120	49	1	70	21	1	212	100	2	70	21	1	125	52
Lead Sulfamate	2	140	60	2	70	21	1	140	60	2	70	21	1	125	52
Linseed Oil	1	200	93	1	70	21	1	250	121	1	70	21	1	300	149
Liquefied Petroleum-Gas	1	250	121	1	70	21	1	176	80	4	70	21	1	200	93
Lubricating Oils	1	70	21	1	70	21	1	158	70	4	70	21	1	300	149
Magnesium Chloride	1	176	80	1	70	21	1	176	80	1	70	21	1	300	149
Magnesium Hydroxide	1	140	60	2	70	21	1	212	100	1	70	21	1	300	149
Magnesium Sulfate	1	176	80	1	70	21	1	boiling	boiling	1	70	21	1	300	149
Maleic Acid	4	176	80	4	70	21	1	140	60	4	70	21	1	300	149
Malic Acid	1	70	21	1	70	21	1	70	21	2	70	21	1	300	149
Methane	1	250	121	1	70	21	2	176	80	4	70	21	1	300	149
Methanol	1	70	21	1	70	21	4	75	24	1	70	21	1	300	149

Rating Key: 1 = Excellent compatibility up to given temperature  
2 = Good compatibility up to given temperature

3 = Limited compatibility up to given temperature  
4 = Poor compatibility up to given temperature

Appendix C – Compound Compatibility Chart **Oil Seals**

Compound Code	Timken Black NBR			Timken Blue HNBR			Timken Green FKM			Silicone VMQ			Gylon® PTFE		
	Rating	°F	°C	Rating	°F	°C	Rating	°F	°C	Rating	°F	°C	Rating	°F	°C
Methyl Alcohol	1	70	21	1	70	21	4	75	24	1	70	21	1	300	149
Methyl Bromide	2	70	21	2	70	21	1	160	71	1	ND	ND	1	300	149
Methyl Ether	1	70	21	1	70	21	1	70	21	1	70	21	1	70	21
Methyl Oleate	4	70	21	4	70	21	1	70	21	ND	ND	ND	1	70	21
Mineral Oil	1	250	121	1	70	21	1	70	21	2	70	21	1	356	180
Naphtha	1	250	121	2	70	21	1	158	70	4	70	21	1	300	149
Naphthalene	4	70	21	4	70	21	1	176	80	4	70	21	1	424	218
Naphthalenic	2	70	21	2	70	21	1	160	71	4	70	21	1	70	21
Natural Gas	1	250	121	1	70	21	1	176	80	4	70	21	1	70	21
Nickel Chloride	1	176	80	1	70	21	1	212	100	1	70	21	1	300	149
Nitric Acid (Dilute)	4	70	21	4	70	21	1	158	70	2	70	21	1	248	120
Octachloroluene	4	70	21	4	70	21	1	70	21	4	70	21	1	70	21
Octadecane	1	70	21	4	70	21	1	70	21	4	70	21	1	70	21
N-Octane	2	70	21	2	70	21	1	70	21	4	70	21	1	300	149
Octyl Alcohol	2	100	38	2	70	21	2	70	21	2	70	21	1	70	21
Oleum Spirits	2	70	21	2	70	21	1	160	71	4	70	21	1	70	21
Oxalic Acid	2	140	60	2	70	21	1	140	60	2	70	21	1	200	93
Oxygen-Cold	2	100	38	4	70	21	1	70	21	1	70	21	1	70	21
Oxygen-Hot	4	250	121	4	70	21	2	400	204	2	70	21	1	400	204
Ozone	4	70	21	1	70	21	1	70	21	1	400	204	1	125	52
Paint Thinner, Duco	4	70	21	4	70	21	2	200	93	4	70	21	1	70	21
Palmitic Acid	1	160	71	1	70	21	1	70	21	4	70	21	1	300	149
Perchloric Acid	4	70	21	4	70	21	3	200	93	4	ND	ND	1	200	93
Perchloroethylene	2	70	21	2	70	21	1	212	100	4	70	21	1	250	121
Petroleum	1	250	121	1	70	21	1	250	121	4	70	21	1	250	121
Phenol	4	70	21	4	70	21	1	140	60	4	ND	ND	1	300	149
Phenyl Benzene	4	70	21	4	70	21	1	300	149	4	70	21	1	300	149
Phenyl Ethyl Ether	4	70	21	4	70	21	4	70	21	4	70	21	1	70	21
Phenyl Hydrazine	4	70	21	4	70	21	1	70	21	1	ND	ND	1	70	21
Phorone	4	70	21	4	70	21	4	70	21	4	70	21	1	70	21
Phosphate Ester	4	70	21	4	70	21	4	70	21	1	70	21	1	70	21
Phosphorus Trichloride	4	70	21	4	70	21	1	70	21		ND	ND	1	300	149
Pickling Solution	4	70	21	4	70	21	2	70	21	4	70	21	1	70	21
Picric Acid (10%)	2	160	71	2	70	21	1	140	60	2	70	21	1	300	149
Pinene	2	70	21	2	70	21	1	158	70	4	70	21	1	boiling	boiling
Piperidine	4	70	21	4	70	21	4	70	21	4	70	21	1	boiling	boiling
Plating Solution - Chrome	4	70	21	4	70	21	1	140	60	4	70	21	1	300	149
Plating Solution - Others	1	70	21	1	70	21	1	70	21	4	70	21	1	70	21
Potassium Acetate	2	120	49	2	70	21	4	70	21	4	70	21	1	390	199
Potassium Chloride	1	176	80	1	70	21	1	212	100	1	70	21	1	70	21
Potassium Cupro-Cyanide	1	140	60	1	70	21	1	212	100	1	70	21	1	70	21
Potassium Cyanide	1	140	60	1	70	21	1	70	21	1	70	21	1	200	93
Potassium Dichromate	1	140	60	1	70	21	1	212	100	1	70	21	1	200	93
Potassium Hydroxide	2	150	66	2	ND	ND	2	70	21	3	70	21	1	300	149
Potassium Nitrate	1	140	60	1	70	21	1	212	100	1	70	21	1	300	149
Potassium Sulfate	1	160	71	1	70	21	1	212	100	1	70	21	1	300	149

Rating Key: 1 = Excellent compatibility up to given temperature  
2 = Good compatibility up to given temperature

3 = Limited compatibility up to given temperature  
4 = Poor compatibility up to given temperature

## Oil Seals Appendix C – Compound Compatibility Chart

Compound Code	Timken Black NBR			Timken Blue HNBR			Timken Green FKM			Silicone VMQ			Gylon® PTFE		
	Rating	°F	°C	Rating	°F	°C	Rating	°F	°C	Rating	°F	°C	Rating	°F	°C
Producer Gas	1	250	121	1	70	21	1	70	21	2	70	21	1	70	21
Propane	1	250	121	1	70	21	1	176	80	4	70	21	1	300	149
Propyl Acetate	4	70	21	4	70	21	4	70	21	4	70	21	1	70	21
N-Propyl Acetate	4	70	21	4	70	21	4	70	21	4	70	21	1	70	21
Propyl Acetone	4	70	21	4	70	21	4	70	21	3	ND	ND	1	70	21
Propyl Alcohol	2	200	93	1	70	21	1	212	100	1	70	21	1	300	149
Propyl Nitrate	4	70	21	4	70	21	4	70	21	4	70	21	1	70	21
Propylene	4	70	21	4	70	21	1	70	21	4	70	21	1	70	21
Propylene Oxide	4	70	21	4	70	21	4	70	21	4	70	21	1	300	149
Pydraul, 10E	4	70	21	4	70	21	1	70	21	4	70	21	1	70	21
Pydraul, 29ELT, 30E, 50E, 65E, 90E	4	70	21	4	70	21	1	158	70	1	70	21	1	70	21
Pydraul, 115E	4	70	21	4	70	21	1	70	21	4	70	21	2	400	204
Pyranol, Transformer Oil	1	70	21	1	70	21	1	70	21	4	70	21	ND	ND	ND
Rapeseed Oil	2	250	1	212	70	21	1	70	21	4	70	21	1	70	21
RJ-1 (MIL-F-25558)	1	70	21	1	70	21	1	70	21	4	70	21	ND	ND	ND
RP-1 (MIL-R-25576)	1	70	21	1	70	21	1	70	21	4	70	21	ND	ND	ND
SAE-10	1	250	121	1	70	21	1	70	21	4	70	21	1	70	21
SAE-30	1	70	21	1	70	21	1	70	21	1	ND	ND	ND	ND	ND
Sal Ammoniac	1	160	71	1	70	21	1	212	100	3	70	21	1	boiling	boiling
Salicylic Acid	2	70	21	2	70	21	1	70	21	1	ND	ND	1	300	149
Salt Water	1	140	60	1	70	21	1	176	80	1	70	21	1	250	121
Sea Water	1	140	60	1	70	21	1	212	100	1	70	21	1	250	121
Sewage	1	200	93	1	70	21	1	176	80	2	70	21	1	70	21
Silicate Esters	2	180	82	2	70	21	ND	400	204	4	70	21	1	70	21
Silicone Greases	1	140	60	1	70	21	1	140	60	3	70	21	1	300	149
Silicone Oils	1	140	60	1	70	21	1	400	204	4	70	21	1	300	149
Silver Nitrate	2	180	82	2	70	21	1	176	80	1	70	21	1	300	149
Soap Solutions	1	200	93	1	70	21	1	212	100	1	70	21	1	300	149
Soda Ash	1	160	71	1	70	21	1	212	100	1	70	21	1	300	149
Sodium Acetate	2	176	80	2	70	21	4	70	21	4	70	21	1	300	149
Sodium Bicarbonate	1	140	60	1	70	21	1	212	100	1	70	21	1	300	149
Sodium Bisulfite	2	212	100	1	70	21	1	212	100	1	70	21	1	200	93
Sodium Borate	1	70	21	1	70	21	1	176	80	1	70	21	1	300	149
Sodium Chloride	1	160	71	1	70	21	1	212	100	1	212	100	1	300	149
Sodium Cyanide	1	140	60	1	ND	ND	1	176	80	1	70	21	1	300	149
Sodium Hydroxide	2	70	21	2	70	21	2	70	21	1	70	21	1	300	149
Sodium Hypochlorite	4	130	54	2	70	21	1	158	70	2	70	21	1	300	149
Sodium Metaphosphate	1	140	60	1	70	21	1	140	60	1	70	21	1	300	149
Sodium Nitrate	2	176	80	2	ND	ND	1	212	100	4	70	21	1	300	149
Sodium Perborate	2	200	93	2	70	21	1	140	60	2	70	21	1	300	149
Sodium Peroxide	2	200	93	2	70	21	1	boiling	boiling	4	70	21	1	300	149
Sodium Phosphates	1	200	93	1	70	21	1	176	80	4	70	21	1	300	149
Sodium Silicate	1	140	60	1	70	21	1	212	100	1	70	21	1	300	149
Sodium Sulfates	1	140	60	1	ND	ND	1	176	80	1	70	21	1	300	149

Rating Key: 1 = Excellent compatibility up to given temperature  
2 = Good compatibility up to given temperature

3 = Limited compatibility up to given temperature  
4 = Poor compatibility up to given temperature

Appendix C – Compound Compatibility Chart **Oil Seals**

Compound Code	Timken Black NBR			Timken Blue HNBR			Timken Green FKM			Silicone VMQ			Gylon® PTFE		
	Rating	°F	°C	Rating	°F	°C	Rating	°F	°C	Rating	°F	°C	Rating	°F	°C
Sodium Thiosulfates	2	200	93	2	ND	ND	1	212	100	1	70	21	1	300	149
Soybean Oil	1	250	121	1	70	21	1	250	121	1	70	21	1	200	93
Stannic Chloride	1	140	60	1	70	21	1	140	60	2	70	21	1	300	149
Steam	4	212	100	4	212	100	1	212	100	4	225	107	1	450	232
Stearic Acid	1	70	21	2	70	21	1	140	60	2	70	21	1	300	149
Stoddards Solvent	12	50	121	1	70	21	1	158	70	4	70	21	1	300	149
Styrene Polymer	4	70	21	4	70	21	1	120	49	4	70	21	1	70	21
Sucrose Solution	1	140	60	2	70	21	1	140	60	1	70	21	1	200	93
Sulfur Chloride	4	70	21	4	70	21	1	140	60	3	70	21	1	300	149
Sulfur Hexafluoride	2	70	21	2	70	21	4	70	21	2	70	21	1	70	21
Sulfur Trioxide	4	70	21	4	70	21	1	140	60	2	70	21	1	300	149
Sulfuric Acid	4	70	21	4	70	21	1	158	70	4	70	21	1	400	204
Sulfur Acid (20% Oleum)	4	70	21	2	70	21	1	75	24	4	70	21	1	400	204
Sulfurous Acid	4	70	21	2	70	21	1	140	60	4	70	21	1	300	149
Tannic Acid	1	200	93	1	70	21	1	140	60	2	70	21	1	300	149
Terpineol	2	70	21	2	70	21	1	70	21	ND	ND	ND	1	70	21
Tertiary Butyl Alcohol	2	70	21	2	70	21	1	70	21	2	70	21	1	70	21
Tertiary Butyl Catechol	4	70	21	4	70	21	1	70	21	1	ND	ND	1	70	21
Tertiary Butyl Mercaptan	4	70	21	4	70	21	1	70	21	4	70	21	1	70	21
Tetrabromoethane	4	70	21	4	70	21	1	70	21	4	70	21	1	boiling	boiling
Tetrabromomethane	4	70	21	4	70	21	1	70	21	4	70	21	1	70	21
Tetrabutyl Titanate	2	70	21	2	70	21	1	70	21	ND	ND	ND	1	70	21
Tetrochloroethylene	4	70	21	4	70	21	1	212	100	4	70	21	1	250	121
Tetraethyl Lead	2	120	49	2	70	21	1	120	49	ND	ND	ND	1	300	149
Tetralin	4	70	21	4	70	21	1	70	21	4	70	21	1	70	21
Titanium Tetrachloride	4	70	21	2	70	21	1	ND	ND	4	70	21	1	300	149
Transformer Oil	1	150	66	1	70	21	1	300	149	2	70	21	1	300	149
Transmission Fluid Type A	1	70	21	1	70	21	1	212	100	2	70	21	1	70	21
Triaryl Phosphate	4	70	21	4	70	21	1	70	21	3	70	21	1	70	21
Tricresyl Phosphate	4	70	21	4	70	21	1	140	60	3	70	21	1	boiling	boiling
Turbine Oil	2	70	21	1	70	21	1	140	60	4	70	21	1	70	21
Turpentine	1	200	93	1	70	21	1	158	70	4	70	21	1	300	149
Varnish	2	70	21	2	70	21	1	70	21	4	70	21	1	70	21
Versilube F-50	1	70	21	1	70	21	1	350	177	3	70	21	1	70	21
Vinyl Chloride	4	70	21	4	70	21	1	70	21	1	ND	ND	1	300	149
Wagner 21B Brake Fluid	3	70	21	3	70	21	4	70	21	3	70	21	1	70	21
Water	1	180	82	1	70	21	2	275	135	2	180	82	1	boiling	boiling
White Oil	1	70	21	1	70	21	1	70	21	4	70	21	1	70	21
White Pine Tar	2	70	21	2	70	21	1	70	21	4	70	21	1	70	21
Xylene	4	70	21	4	70	21	1	140	60	4	70	21	1	300	149
Xylidines	4	70	21	ND	ND	ND	4	70	21	4	70	21	1	70	21
Zeolites	1	70	21	1	70	21	1	70	21	ND	ND	ND	ND	ND	ND
Zinc Acetate	2	176	80	2	70	21	4	176	80	4	70	21	1	70	21
Zinc Chloride	1	140	60	1	70	21	1	212	100	2	70	21	1	300	149
Zinc Sulfate	1	140	60	1	70	21	1	boiling	boiling	1	70	21	1	300	149

Rating Key: 1 = Excellent compatibility up to given temperature  
2 = Good compatibility up to given temperature

3 = Limited compatibility up to given temperature  
4 = Poor compatibility up to given temperature

**Identifying the Cause**

If just one seal in a heavy industrial application becomes damaged or fails to operate properly, it can result in extensive product and equipment damage, lengthy downtime and unexpected maintenance costs. Familiarizing yourself with damage analysis techniques can help you prevent further damage to equipment while identifying how to stop future seal and machine damage before it occurs.

The diagram below organizes common symptoms with common root causes of seal failure and is designed to help you:

- Sort possible causes of failure in a logical manner
- Identify areas for data gathering
- Identify, explore and display all possible causes related to the failure to determine the root cause
- Keep any collaboration on defining the root cause focused and on track

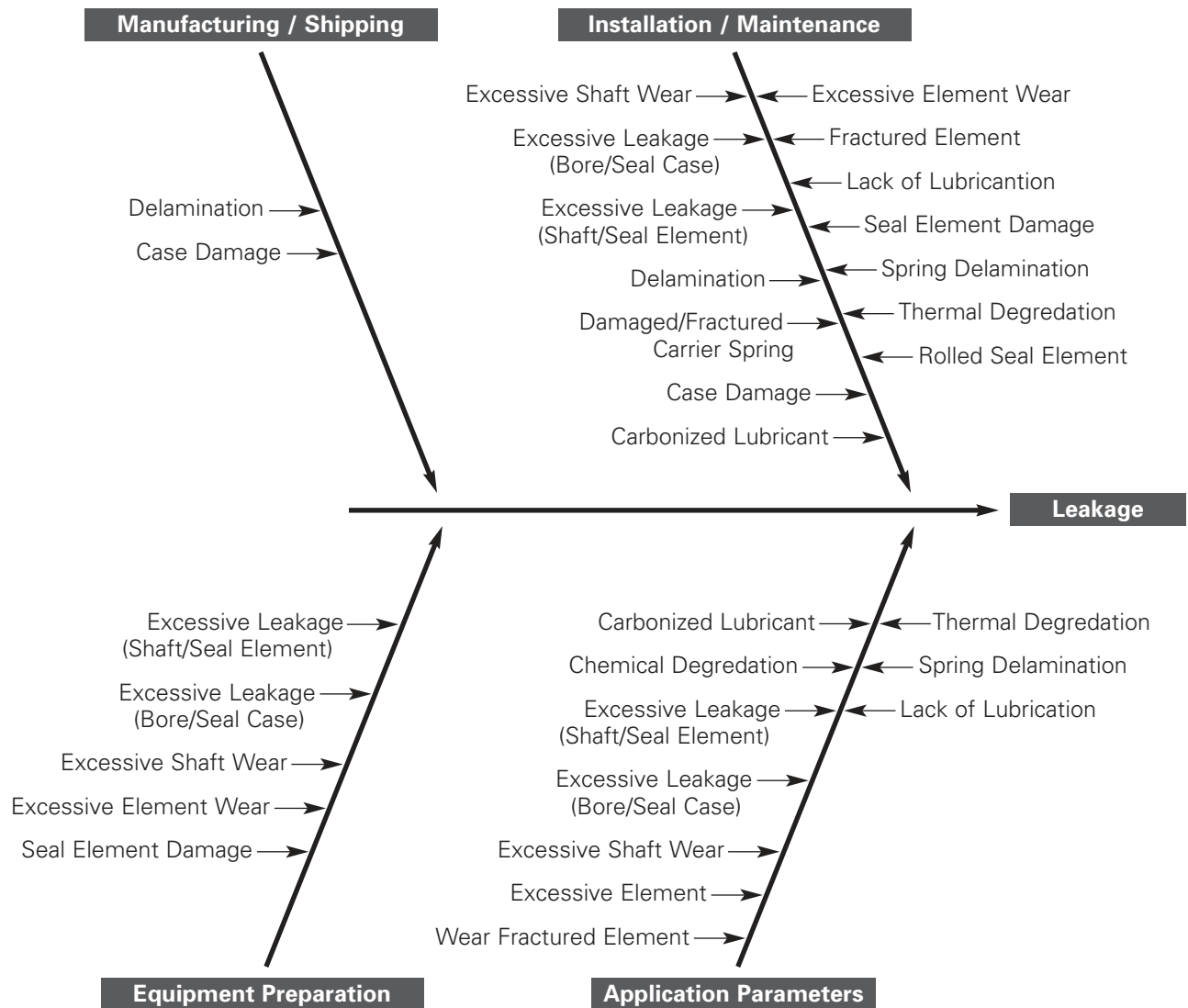



The following information pertains to standard installations. If you have a special installation or need advice, contact your Timken sales representative. For more information on both seal and bearing damage analysis, go to [www.timken.com/industrialseals](http://www.timken.com/industrialseals).

**Carbonized Lubricant**

*Problem*  
Lubricant breaks down, deposits around the main sealing interface and interferes with sealing capabilities



*Potential Cause*  
• Bearing lubricant becomes overheated

*Potential Solution*  
• Use a lubricant that can withstand greater temperatures or decrease the temperature for current lubricant

**Case Damage**

*Problem*  
Seal case is damaged



*Potential Cause*  
• Improper installation  
  
• Improper shipping

*Potential Solution*  
• Change installation technique to prevent damage  
• Contact your Timken sales representative to discuss shipping alternatives and replacement

**Chemical Degradation**

*Problem*  
Abnormal swelling or distortion of the sealing element

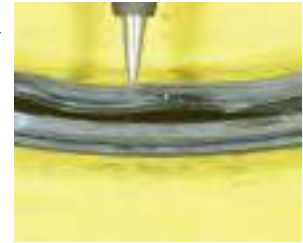

*Potential Cause*  
• Sealing element material and the material being sealed (i.e. lubricant, coolant) are chemically incompatible

*Potential Solution*  
• Upgrade to sealing element that is compatible with the material being sealed

**Delamination**

*Problem*  
Seal material separates, interfering with sealing capabilities

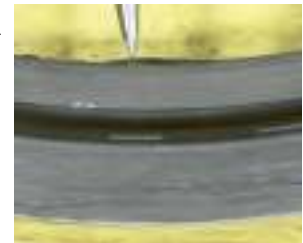

*Potential Cause*  
Trapped air due to:  
• Improper installation  
  
• Improper shipping

*Potential Solution*  
• Change installation technique to prevent damage  
• Contact your Timken sales representative to discuss shipping alternatives and replacement  
• Contact your Timken sales representative to report manufacturing defect and arrange for replacement

**Fractured Carrier Spring**

*Problem*

Ineffective sealing due to distortion or cracking of the carrier spring



*Potential Cause*

- Improper installation
- Excessive load

*Potential Solution*

- Change installation technique to prevent damage
- Do not allow seal to carry the weight of the shaft

**Excessive Leakage (Shaft/Seal Element)**

*Problem*

Leakage occurs between shaft and seal lip

*Potential Cause*

- Incorrect seal/shaft size
- Rough surface finish on shaft
- Too much lubricant used during installation
- Shaft machined lead (spiral grooves)
- Cocked seal installation
- Excessive shaft movement (TIR)
- Previously mentioned failure modes

*Potential Solution*

- Use correct seal size
- Refinish shaft surface to seal specifications
- Reduce amount of installation lubricant
- Refinish shaft surface to seal specifications
- Install seal squarely into housing bore
- Move seal closer to bearing
- Reference previously mentioned sources/ solutions

**Excessive Leakage (Bore/Seal Case)**

*Problem*

Leakage occurs between bore and seal case

*Potential Cause*

- Incorrect seal/bore size
- Rough surface finish on bore
- Use of lubricant during installation
- Cocked seal installation

*Potential Solution*

- Use correct seal size
- Refinish bore surface to seal specifications
- Do not use lubricant during installation (not recommended for the bore and seal case)
- Install seal squarely into housing bore

**Excessive Seal Element Wear**

*Problem*

Wider than normal wear pattern on the surface of seal element



*Potential Cause*

- Excessive internal pressure
- High misalignment/runout
- Rough surface finish on shaft
- Insufficient lubrication
- Extended seal service
- Oversized shaft

*Potential Solution*

- Clean drain ports and chamber vents or upgrade to seal with higher pressure capabilities
- Upgrade to seal with higher misalignment/runout capabilities
- Refinish surface of shaft to seal specifications
- Properly lubricate the seal
- Upgrade to extended service element material or change maintenance schedule to accommodate new seal life requirements
- Use proper seal size

**Rolled Seal Element**

*Problem*

Seal was rolled



*Potential Cause*

- Damage during installation

*Potential Solution*

- Change installation technique or use proper tools to prevent seal damage

### Fractured Element

*Problem*  
Seal fractures or splits



*Potential Cause*

- Damage during installation
- Excessive load
- Thermal degradation
- Insufficient lubrication

*Potential Solution*

- Change installation technique to prevent seal damage
- Do not allow seal to carry the weight of the shaft
- Reduce operating temperature or upgrade to a compatible seal element
- Apply proper amount of lubrication at sealing interface during installation

### Low Lubrication Levels

*Problem*  
Cracks or wear patterns develop, hindering sealing capabilities

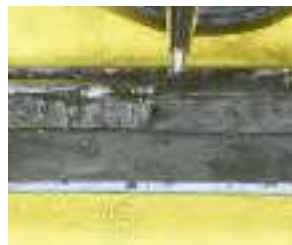

*Potential Cause*

- Insufficient lubrication
- High internal pressure

*Potential Solution*

- Increase lubrication during installation
- Decrease internal pressure

### Excessive Shaft Wear

*Problem*  
Excess wear groove in shaft



*Potential Cause*

- Abrasive damage during installation
- Abrasive damage during operation
- Soft shaft material

*Potential Solution*

- Clean shaft and seal prior to installation
- Prevent abrasive materials from collecting at sealing interface during operation
- Make sure shaft hardness is sufficient for seal specifications

### Seal Element Damage

*Problem*  
Seal element has nicks, cuts or tears



*Potential Cause*

- Rough surface finish on shaft
- Damage during installation

*Potential Solution*

- Refinish shaft to seal specifications
- Change installation technique to prevent damage

### Spring Delamination

*Problem*  
Sealing element and spring separate, causing leakage



*Potential Cause*

- Excessive load
- Excessive operating temperature

*Potential Solution*

- Upgrade to seal material with higher misalignment capabilities
- Upgrade to seal material with higher temperature capabilities

### Thermal Delamination

*Problem*  
Cracks occur on sealing lip, causing leakage and contamination



*Potential Cause*

- High temperature at sealing interface

*Potential Solution*

- Upgrade to seal material that is compatible with application's temperature requirements, or reduce application's operating temperature

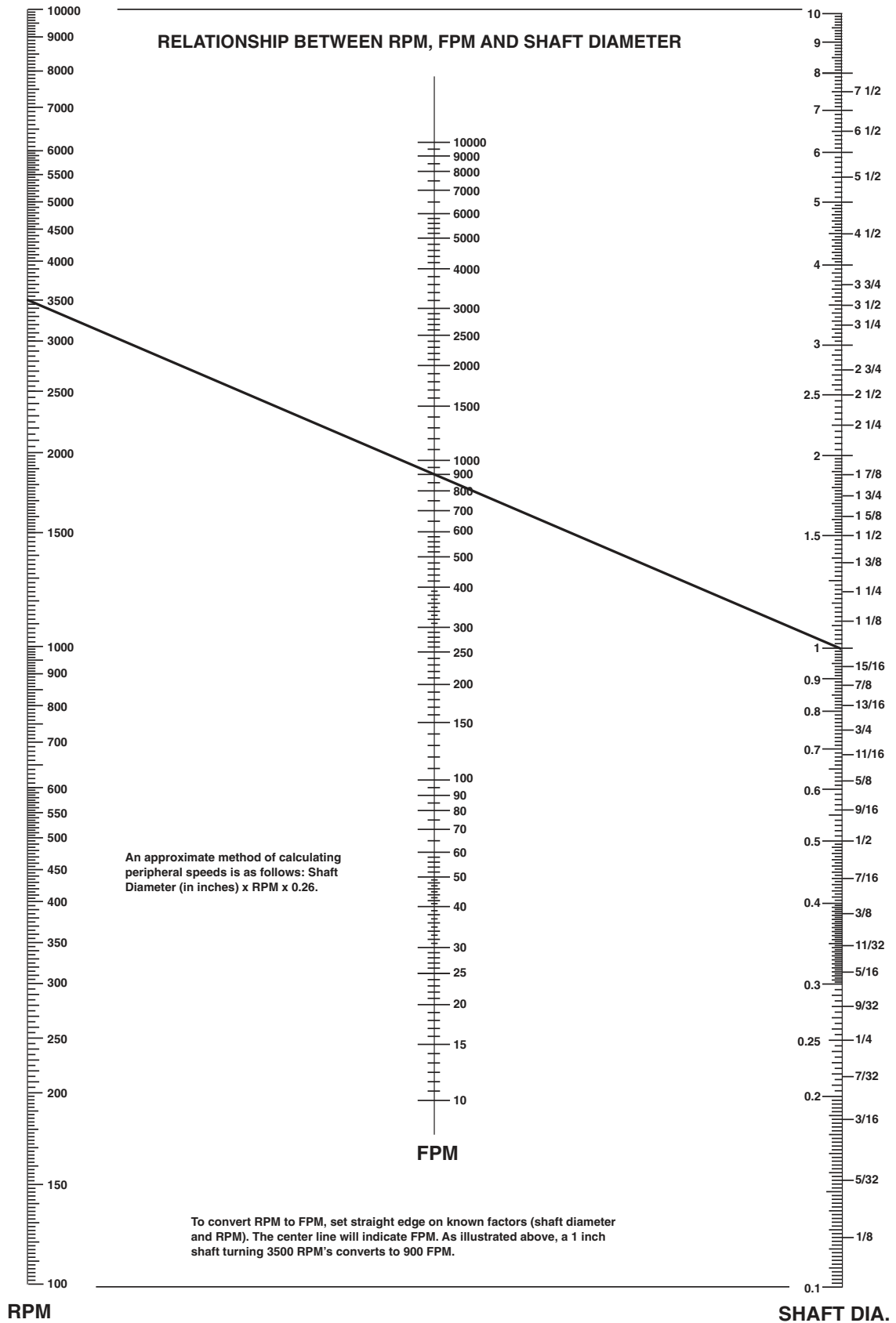





**TIMKEN**

**Seals by Model Number**



### Using This Catalog

The following pages contain the information you need to make accurate decisions about the seals best suited for your standard applications. This catalog lists Timken oil seals and bearing isolators by model number and includes:

Part numbers and dimensions for shaft, bore and width.

Preferred sizes appearing in bold typeface.

Reference chart showing relationship between RPM, FPM and shaft diameters.

To learn about Timken oil seals for non-standard applications, contact your Timken sales representative.

# Index for Model Number

<b>Model Number to Part Number Conversion</b>	M-4
<b>Timken® Oil Seals and Bearing Isolators by Model Number</b>	M-5
<b>Timken® Face Seals and Bearing Isolators by Model Number</b>	M-166

## Model Number to Part Number Conversion

Model No.	Prefix	Model No.	Prefix
3	28003	68	21823
21	25001	68R2	23727
23	25003	71	26001
24	25005	76	26193
25	25058		
		87	26080
26	24600	88	26088
26R1	24620	88NS	26188
53	21086	91	27023
53F1	22987	92	27063
53R1	22537		
		94	27223
53R2	22627	111	21011
53T2	22897	113	21012
53TB	22807	123	21016
53TF	22994	142	21432
54	21140		
		145A1	21700
58	21003	145A2	21750
59	24700	EQ	24801
61	24060	EQ	24802
61 FDA	24061	EQ	24807
61 DBL TANDEM	24062		
		EQSPB	24816
61 DBL OPPOSED	24063	IG	29500
61 REVERSE LIP	24064	IG	29502
62	21702	IG	29507
63	21158	IG	29519
63F1	23078		
		IGSPB	29516
63R1	23547		
63R2	23548		
63T2	23550		
63TB	23549		
63TF	23735		
64	21238		
66	21527		
66F1	23692		
66R1	23722		
66R2	23702		
66T2	23728		
66TF	23763		
67	21528		
67R2	23683		
67T2	23621		



## Oil Seals by Model Number

Product Code	Model	Inches			MM			Product Code	Model	Inches			MM		
		ID	OD	Width	ID	OD	Width			ID	OD	Width	ID	OD	Width
25001-0524	21	7.000	8.750	0.500	178	222	13	25001-4633	21	6.299	7.875	0.630	160	200	16
25001-0794	21	11.250	12.250	0.583	286	311	15	25001-4675	21-L	24.500	25.625	0.500	622	651	13
25001-0965	21	7.824	9.375	0.750	199	238	19	25001-4676	21-L	25.750	26.875	0.500	654	683	13
25001-1055	21-L	19.750	22.000	0.813	502	559	21	25001-4712	21-L	17.000	19.000	0.875	432	483	22
25001-1056	21-L	19.875	22.000	0.813	505	559	21	25001-4779	21-L	13.250	15.250	0.813	337	387	21
25001-1380	21	4.500	6.500	0.500	114	165	13	25001-4780	21	6.000	8.250	0.750	152	210	19
25001-2062	21	8.125	10.000	0.750	206	254	19	25001-4795	21-L	15.875	17.750	0.875	403	451	22
25001-2087	21-L	18.437	20.500	0.813	468	521	21	25001-4971	21-L	17.000	18.125	0.547	432	460	14
25001-2915	21	5.000	6.000	0.500	127	152	13	25001-5023	21	3.000	4.000	0.375	76	102	10
25001-3003	21	8.000	10.000	0.625	203	254	16	25001-5038	21-L	16.500	18.500	0.875	419	470	22
25001-3023	21	5.125	7.500	0.500	130	191	13	25001-5055	21-L	20.500	22.500	0.813	521	572	21
25001-3151	21	5.375	7.500	0.625	137	191	16	25001-5062	21-L	14.250	15.750	0.750	362	400	19
25001-3254	21-L	24.000	25.000	0.500	610	635	13	25001-5312	21-L	21.000	22.750	0.750	533	578	19
25001-3288	21	5.750	7.500	0.563	146	191	14	25001-5373	21	8.268	9.843	0.618	210	250	16
25001-3334	21	5.875	7.500	0.750	149	191	19	25001-5410	21	6.500	8.500	0.585	165	216	15
25001-3441	21	5.625	8.125	0.750	143	206	19	25001-5552	21-L	24.000	25.125	0.500	610	638	13
25001-3468	21	6.750	8.500	0.625	171	216	16	25001-5906	21	10.000	12.000	0.688	254	305	17
25001-3504	21	7.000	8.750	0.625	178	222	16	25001-5919	21-L	24.000	26.000	0.813	610	660	21
25001-3535	21	5.625	7.875	0.500	143	200	13	25001-5934	21	10.500	11.750	0.625	267	298	16
25001-3541	21	7.375	9.125	0.750	187	232	19	25001-6378	21	7.500	8.500	0.500	191	216	13
25001-3556	21	7.500	9.250	0.625	191	235	16	25001-6383	21	8.500	9.500	0.500	216	241	13
25001-3557	21	7.500	9.250	0.750	191	235	19	25001-6384	21	8.500	9.750	0.625	216	248	16
25001-3623	21	9.000	11.000	0.750	229	279	19	25001-6387	21	9.000	10.000	0.500	229	254	13
25001-3642	21	9.500	11.000	0.625	241	279	16	25001-6388	21	9.500	10.500	0.500	241	267	13
25001-3728	21-L	14.500	16.500	0.750	368	419	19	25001-6389	21	9.625	11.625	0.750	244	295	19
25001-3925	21	8.000	10.000	0.750	203	254	19	25001-6396	21-L	12.750	14.750	0.750	324	375	19
25001-3926	21	8.000	10.000	0.813	203	254	21	25001-6397	21-L	16.250	18.250	0.813	413	464	21
25001-3937	21	8.500	10.000	0.750	216	254	19	25001-6399	21-L	18.000	20.000	0.813	457	508	21
25001-3943	21	8.625	10.500	0.750	219	267	19	25001-6401	21-L	22.000	24.000	0.813	559	610	21
25001-3951	21	8.750	10.750	0.750	222	273	19	25001-6407	21-L	42.000	44.000	0.813	1067	1118	21
25001-3979	21	9.500	11.000	0.750	241	279	19	25001-6426	21-L	19.750	21.750	0.813	502	552	21
25001-3983	21	9.500	11.500	0.750	241	292	19	25001-6508	21-L	19.000	21.000	0.813	483	533	21
25001-3984	21	9.500	11.500	0.813	241	292	21	25001-6559	21	3.500	4.390	0.336	89	112	9
25001-3989	21	9.750	11.750	0.750	248	298	19	25001-6879	21-L	23.500	25.500	0.813	597	648	21
25001-4005	21	10.250	11.750	0.750	260	298	19	25001-6910	21-L	23.250	25.250	0.813	591	641	21
25001-4017	21	10.500	12.500	0.813	267	318	21	25001-6973	21	7.875	9.875	0.625	200	251	16
25001-4047	21	11.250	13.250	0.813	286	337	21	25001-7138	21-L	34.000	36.000	0.813	864	914	21
25001-4094	21-L	13.000	14.500	0.750	330	368	19	25001-7213	21	3.125	3.875	0.375	79	98	10
25001-4099	21-L	13.000	15.000	0.813	330	381	21	25001-7412	21-L	31.000	33.000	0.813	787	838	21
25001-4102	21-L	13.250	14.750	0.750	337	375	19	25001-7827	21-L	43.000	45.000	0.812	1092	1143	21
25001-4132	21-L	14.000	15.500	0.750	356	394	19	25001-7838	21-L	23.000	25.000	0.813	584	635	21
25001-4135	21-L	14.000	16.000	0.813	356	406	21	25001-7912	21	7.725	9.375	0.750	196	238	19
25001-4140	21-L	14.250	16.250	0.813	362	413	21	25001-8208	21-L	22.000	23.125	0.547	559	587	14
25001-4147	21-L	14.750	16.250	0.688	375	413	17	25001-8271	21-L	14.875	16.875	0.813	378	429	21
25001-4152	21-L	15.000	16.500	0.750	381	419	19	25001-8446	21-L	19.500	21.500	0.812	495	546	21
25001-4155	21-L	15.000	17.000	0.750	381	432	19	25001-8560	21	8.500	10.500	0.500	216	267	13
25001-4156	21-L	15.000	17.000	0.813	381	432	21	25001-8564	21	9.000	10.910	0.838	229	277	21
25001-4162	21-L	15.500	17.000	0.750	394	432	19	25001-8606	21	8.661	10.236	0.630	220	260	16
25001-4163	21-L	15.500	17.500	0.813	394	445	21	25001-8742	21	10.000	11.910	0.838	254	303	21
25001-4178	21-L	16.000	17.500	0.750	406	445	19	25001-8773	21-L	25.625	26.750	0.500	651	679	13
25001-4180	21-L	16.000	18.000	0.813	406	457	21	25001-9267	21	8.375	10.375	0.750	213	264	19
25001-4189	21-L	17.000	18.500	0.750	432	470	19	25001-9477	21-L	18.750	20.250	0.813	476	514	21
25001-4207	21-L	18.000	19.750	0.750	457	502	19	25001-9521	21	8.267	9.842	0.630	210	250	16
25001-4211	21-L	18.250	19.750	0.750	464	502	19	25001-9568	21-L	41.000	43.000	0.812	1041	1092	21
25001-4441	21	12.063	13.625	0.750	306	346	19	25001-9696	21-L	14.750	16.250	0.668	375	413	17
25001-4532	21-L	13.750	15.750	0.750	349	400	19	25001-9835	21	7.875	9.500	0.750	200	241	19

All dimensions are in inches. Preferred sizes are indicated with **bold** type face.

Sizes listed are for standard nitrile elements, except Models 25 and 62 which have PTFE elements. Other material available on inquiry only.

## Oil Seals by Model Number

Product Code	Model	Inches			MM			Product Code	Model	Inches			MM		
		ID	OD	Width	ID	OD	Width			ID	OD	Width	ID	OD	Width
25001-9893	21-L	20.625	22.625	0.812	524	575	21	25003-0479	23-L	16.094	17.500	0.750	409	445	19
25002-3151	21	5.375	7.500	0.625	137	191	16	25003-0480	23-L	14.094	15.500	0.750	358	394	19
25002-3468	21	6.750	8.500	0.625	171	216	16	25003-0483	23-L	21.250	22.637	0.590	540	575	15
25002-4135	21-L	14.000	16.000	0.813	356	406	21	25003-0489	23-L	13.250	14.250	0.500	337	362	13
25002-5373	21	8.267	9.842	0.618	210	250	16	25003-0500	23	5.523	6.500	0.500	140	165	13
25002-5919	21-L	24.000	26.000	0.813	610	660	21	25003-0501	23-L	30.500	32.500	1.000	775	826	25
25002-6387	21	9.000	10.000	0.500	229	254	13	25003-0503	23	3.907	5.118	0.500	99	130	13
25002-6473	21-L	38.500	40.500	0.813	978	1029	21	25003-0504	23	7.480	8.661	0.472	190	220	12
25002-6849	21-L	30.000	32.000	0.813	762	813	21	25003-0506	23-L	22.625	24.125	0.500	575	613	13
25002-7407	21-L	21.500	23.500	0.813	546	597	21	25003-0510	23-L	17.717	18.898	0.500	450	480	13
25002-7413	21-L	18.000	19.750	0.813	457	502	21	25003-0518	23-L	18.110	19.843	0.787	460	504	20
25002-8773	21-L	25.625	26.750	0.500	651	679	13	25003-0519	23	5.748	7.087	0.591	146	180	15
25002-9554	21-L	37.500	39.500	0.813	953	1003	21	25003-0521	23	3.188	4.437	0.375	81	113	10
25008-1702	21	6.440	7.969	0.750	164	202	19	25003-0527	23	6.250	7.250	0.375	159	184	10
25008-3003	21	8.000	10.000	0.625	203	254	16	25003-0528	23	9.437	10.750	0.625	240	273	16
25008-3925	21	8.000	10.000	0.750	203	254	19	25003-0530	23	6.000	7.000	0.375	152	178	10
25008-6387	21	9.000	10.000	0.500	229	254	13	25003-0570	23	8.560	9.810	0.625	217	249	16
25008-7838	21-L	23.000	25.000	0.813	584	635	21	25003-0579	23	9.000	10.032	0.500	229	255	13
25008-8773	21-L	25.625	26.750	0.500	651	679	13	25003-0581	23	5.098	6.598	0.500	129	168	13
25008-9432	21-L	22.750	24.330	0.578	578	618	15	25003-0582	23-L	23.428	24.928	0.750	595	633	19
25008-9521	21	8.267	9.843	0.630	210	250	16	25003-0584	23	6.496	7.480	0.512	165	190	13
25018-2742	21	8.250	10.000	0.750	210	254	19	25003-0587	23	4.330	5.393	0.500	110	137	13
25018-2743	21	8.250	9.812	0.750	210	249	19	25003-0589	23	5.525	6.500	0.500	140	165	13
25018-3415	21	6.375	7.625	0.625	162	194	16	25003-0590	23-L	12.992	14.173	0.394	330	360	10
25018-4017	21	10.500	12.500	0.812	267	318	21	25003-0591	23-L	13.780	14.961	0.394	350	380	10
25018-4152	21-L	15.000	16.500	0.750	381	419	19	25003-0599	23	12.250	13.500	0.750	311	343	19
25018-4211	21-L	18.250	19.750	0.750	464	502	19	25003-0606	23-L	21.890	23.858	0.811	556	606	21
25018-6508	21-L	19.000	21.000	0.813	483	533	21	25003-0614	23-L	14.961	16.535	0.787	380	420	20
25053-3334	21	5.875	7.500	0.750	149	191	19	25003-0617	23-L	12.750	14.688	0.813	324	373	21
25063-8294	21-L	20.472	22.441	0.787	520	570	20	25003-0620	23-L	17.323	19.323	0.750	440	491	19
25127-6401	21-L	22.000	24.000	0.813	559	610	21	25003-0623	23	12.000	13.875	0.437	305	352	11
25136-5082	21	9.875	11.875	0.750	251	302	19	25003-0626	23-L	24.625	25.500	0.375	625	648	10
25003-0128	23	2.857	3.857	0.375	73	98	10	25003-0627	23	5.437	6.375	0.500	138	162	13
25003-0202	23	4.062	5.256	0.469	103	134	12	25003-0637	23	6.693	7.677	0.492	170	195	12
25003-0203	23-L	12.938	14.250	0.625	329	362	16	25003-0639	23-L	18.898	20.866	1.047	480	530	27
25003-0205	23	10.688	11.742	0.625	271	298	16	25003-0641	23	10.375	12.000	0.750	264	305	19
25003-0208	23-L	30.688	31.750	0.500	779	806	13	25003-0662	23-L	15.000	16.250	0.813	381	413	21
25003-0241	23-L	14.177	15.500	0.750	360	394	19	25003-0663	23-L	25.625	27.625	0.813	651	702	21
25003-0375	23-L	32.125	34.688	0.750	816	881	19	25003-0671	23-L	25.750	28.125	0.750	654	714	19
25003-0408	23	4.449	5.472	0.375	113	139	10	25003-0674	23	5.515	6.497	0.500	140	165	13
25003-0416	23	11.417	12.992	0.709	290	330	18	25003-0676	23-L	22.000	23.125	0.500	559	587	13
25003-0417	23-L	52.500	55.000	0.750	1334	1397	19	25003-0677	23	12.318	13.694	0.500	313	348	13
25003-0419	23	5.060	5.934	0.375	129	151	10	25003-0678	23	11.150	12.526	0.500	283	318	13
25003-0420	23	11.250	13.250	0.625	286	337	16	25003-0688	23	4.563	6.062	0.500	116	154	13
25003-0422	23	3.847	5.063	0.375	98	129	10	25003-0690	23-L	13.875	15.500	0.600	352	394	15
25003-0429	23-L	21.811	23.386	0.787	554	594	20	25003-0691	23-L	12.188	14.000	0.750	310	356	19
25003-0432	23-L	15.500	17.375	0.813	394	441	21	25003-0692	23	3.625	4.750	0.375	92	121	10
25003-0450	23-L	15.375	16.750	0.750	391	425	19	25003-0695	23	10.158	11.417	0.630	258	290	16
25003-0453	23-L	13.750	15.000	0.750	349	381	19	25003-0696	23-L	25.875	26.750	0.375	657	679	10
25003-0458	23-L	28.486	29.860	0.688	724	758	17	25003-0697	23	11.813	13.813	0.813	300	351	21
25003-0459	23-L	52.186	54.186	0.813	1326	1376	21	25003-0710	23	2.559	3.346	0.375	65	85	10
25003-0460	23-L	44.185	46.188	0.813	1122	1173	21	25003-0716	23-L	17.938	19.313	0.813	456	491	21
25003-0464	23-L	23.512	25.512	0.813	597	648	21	25003-0720	23-L	75.188	77.188	0.813	1910	1961	21
25003-0466	23	9.125	10.799	0.703	232	274	18	25003-0726	23-L	13.625	15.031	0.750	346	382	19
25003-0476	23	9.409	10.909	0.625	239	277	16	25003-0736	23	4.313	5.437	0.500	110	138	13
25003-0477	23-L	17.750	19.373	0.750	451	492	19	25003-0738	23	5.437	6.500	0.500	138	165	13

All dimensions are in inches. Preferred sizes are indicated with **bold** type face.  
 Sizes listed are for standard nitrile elements, except Models 25 and 62 which have PTFE elements. Other material available on inquiry only.

## Oil Seals by Model Number

Product Code	Model	Inches			MM			Product Code	Model	Inches			MM		
		ID	OD	Width	ID	OD	Width			ID	OD	Width	ID	OD	Width
25003-0740	23	11.181	12.992	0.622	284	330	16	25003-1018	23-L	14.500	15.750	0.750	368	400	19
25003-0741	23	5.938	6.875	0.500	151	175	13	25003-1022	23	3.625	4.625	0.437	92	117	11
25003-0743	23	5.500	6.563	0.500	140	167	13	25003-1024	23	4.724	6.000	0.500	120	152	13
25003-0746	23	8.465	9.845	0.645	215	250	16	25003-1025	23	4.960	5.885	0.500	126	149	13
25003-0753	23-L	19.625	21.079	0.531	498	535	13	25003-1026	23	10.236	12.000	0.813	260	305	21
25003-0755	23-L	26.875	28.125	0.500	683	714	13	25003-1027	23	10.630	12.362	0.787	270	314	20
25003-0785	23-L	14.438	15.938	0.625	367	405	16	25003-1029	23	3.563	4.500	0.469	91	114	12
25003-0793	23	2.441	3.346	0.394	62	85	10	25003-1030	23	10.000	10.875	0.375	254	276	10
25003-0795	23	6.495	7.525	0.500	165	191	13	25003-1031	23	11.417	12.992	0.787	290	330	20
25003-0800	23-L	15.784	17.000	0.500	401	432	13	25003-1032	23-L	16.000	17.875	0.750	406	454	19
25003-0801	23	7.283	8.268	0.500	185	210	13	25003-1033	23	3.150	3.938	0.394	80	100	10
25003-0803	23	6.002	7.002	0.500	152	178	13	25003-1034	23	3.500	4.813	0.500	89	122	13
25003-0806	23	2.812	3.560	0.375	71	90	10	25003-1035	23	11.500	13.250	0.813	292	337	21
25003-0818	23-L	13.000	14.500	0.812	330	368	21	25003-1036	23	9.449	10.827	0.709	240	275	18
25003-0821	23	10.229	11.729	0.750	260	298	19	25003-1037	23	10.300	11.550	0.625	262	293	16
25003-0822	23-L	24.500	25.375	0.375	622	645	10	25003-1038	23-L	19.750	21.250	0.750	502	540	19
25003-0839	23-L	20.750	22.250	0.750	527	565	19	25003-1039	23	2.835	3.740	0.375	72	95	10
25003-0866	23	4.134	5.512	0.473	105	140	12	25003-1041	23	3.720	4.720	0.500	94	120	13
25003-0872	23	10.236	12.205	0.630	260	310	16	25003-1042	23	1.875	2.625	0.375	48	67	10
25003-0880	23-L	36.500	38.438	1.000	927	976	25	25003-1049	23	10.710	12.511	0.625	272	318	16
25003-0881	23-L	39.000	40.938	1.000	991	1040	25	25003-1061	23	7.938	9.000	0.500	202	229	13
25003-0890	23	11.024	12.205	0.787	280	310	20	25003-1064	23	9.947	11.875	0.500	253	302	13
25003-0891	23	8.661	10.236	0.591	220	260	15	25003-1072	23	9.750	10.625	0.500	248	270	13
25003-0893	23-L	13.386	14.961	0.708	340	380	18	25003-1079	23	9.947	10.875	0.500	253	276	13
25003-0895	23	2.938	4.000	0.500	75	102	13	25003-1082	23	8.750	10.500	0.813	222	267	21
25003-0896	23-L	28.250	29.500	0.625	718	749	16	25003-1085	23	2.437	3.672	0.500	62	93	13
25003-0897	23	11.024	12.992	0.610	280	330	15	25003-1087	23	3.430	4.625	0.458	87	117	12
25003-0904	23	1.750	2.500	0.375	44	64	10	25003-1091	23-L	66.875	68.000	0.563	1699	1727	14
25003-0917	23	2.938	4.000	0.500	75	102	13	25003-1098	23-L	25.000	26.250	0.625	635	667	16
25003-0926	23	5.118	6.118	0.375	130	155	10	25003-1099	23	9.844	11.220	0.630	250	285	16
25003-0929	23	4.279	5.500	0.375	109	140	10	25003-1103	23-L	12.598	14.173	0.787	320	360	20
25003-0932	23	11.417	13.417	0.813	290	341	21	25003-1107	23	7.875	9.500	0.629	200	241	16
25003-0935	23-L	20.470	22.470	0.813	520	571	21	25003-1108	23-L	12.402	14.173	0.787	315	360	20
25003-0948	23-L	49.500	50.750	0.750	1257	1289	19	25003-1109	23	9.055	10.189	0.625	230	259	16
25003-0949	23	12.000	13.875	0.500	305	352	13	25003-1110	23	3.740	4.740	0.375	95	120	10
25003-0952	23-L	74.500	76.500	0.812	1892	1943	21	25003-1111	23	5.906	7.087	0.512	150	180	13
25003-0953	23	7.375	8.250	0.438	187	210	11	25003-1112	23-L	24.016	25.748	0.787	610	654	20
25003-0954	23	12.000	13.250	0.750	305	337	19	25003-1113	23-L	12.598	14.173	0.708	320	360	18
25003-0957	23	8.611	10.236	0.750	219	260	19	25003-1115	23-L	18.125	19.750	0.750	460	502	19
25003-0959	23-L	26.000	27.250	0.625	660	692	16	25003-1118	23-L	48.000	50.000	0.750	1219	1270	19
25003-0961	23	8.465	9.764	0.590	215	248	15	25003-1121	23-L	51.000	53.000	0.750	1295	1346	19
25003-0977	23	4.331	5.331	0.500	110	135	13	25003-1124	23	11.125	13.000	0.750	283	330	19
25003-0980	23	7.717	8.661	0.472	196	220	12	25003-1125	23-L	17.250	18.500	0.625	438	470	16
25003-0983	23	7.000	8.450	0.563	178	215	14	25003-1126	23-L	17.000	17.906	0.500	432	455	13
25003-0985	23	9.000	10.125	0.500	229	257	13	25003-1127	23	6.875	7.875	0.375	175	200	10
25003-0986	23-L	13.500	14.500	0.500	343	368	13	25003-1145	23	3.938	5.256	0.469	100	134	12
25003-0990	23	12.147	13.688	0.625	309	348	16	25003-1146	23	10.375	11.633	0.813	264	295	21
25003-0992	23	4.295	5.295	0.375	109	134	10	25003-1152	23	7.800	8.800	0.500	198	224	13
25003-0993	23	2.883	3.633	0.375	73	92	10	25003-1158	23-L	17.625	19.375	0.750	448	492	19
25003-0995	23	4.375	5.812	0.500	111	148	13	25003-1160	23	4.688	5.625	0.500	119	143	13
25003-0996	23	3.437	4.500	0.375	87	114	10	25003-1165	23	9.000	10.910	0.813	229	277	21
25003-1000	23	3.938	5.040	0.400	100	128	10	25003-1169	23-L	26.968	27.953	0.500	685	710	13
25003-1002	23	5.118	6.260	0.488	130	159	12	25003-1172	23	6.000	7.500	0.375	152	191	10
25003-1004	23	6.221	7.250	0.500	158	184	13	25003-1173	23-L	12.438	14.375	0.813	316	365	21
25003-1010	23	3.740	4.921	0.472	95	125	12	25003-1175	23-L	15.000	16.250	0.625	381	413	16
25003-1014	23	7.874	9.370	0.748	200	238	19	25003-1176	23-L	12.438	14.438	0.813	316	367	21

All dimensions are in inches. Preferred sizes are indicated with **bold** type face.

Sizes listed are for standard nitrile elements, except Models 25 and 62 which have PTFE elements. Other material available on inquiry only.

## Oil Seals by Model Number

Product Code	Model	Inches			MM			Product Code	Model	Inches			MM		
		ID	OD	Width	ID	OD	Width			ID	OD	Width	ID	OD	Width
25003-1179	23-L	17.716	19.685	0.813	450	500	21	25003-1459	23-L	17.000	18.500	0.720	432	470	18
25003-1181	23-L	20.111	22.111	0.813	511	562	21	25003-1460	23-L	48.250	49.750	0.750	1226	1264	19
25003-1182	23-L	12.599	14.252	0.815	320	362	21	25003-1461	23	10.125	11.625	0.500	257	295	13
25003-1202	23-L	14.173	15.905	0.787	360	404	20	25003-1463	23	8.437	9.938	0.500	214	252	13
25003-1204	23	2.000	3.000	0.375	51	76	10	25003-1464	23	7.125	8.625	0.437	181	219	11
25003-1206	23	2.000	3.000	0.500	51	76	13	25003-1465	23	11.031	12.031	0.500	280	306	13
25003-1212	23	2.000	3.125	0.500	51	79	13	25003-1480	23	2.250	3.125	0.375	57	79	10
25003-1214	23	7.480	9.055	0.630	190	230	16	25003-1482	23	2.250	3.125	0.500	57	79	13
25003-1224	23-L	22.500	23.500	0.500	572	597	13	25003-1492	23	2.250	3.250	0.375	57	83	10
25003-1227	23-L	55.250	56.500	0.750	1403	1435	19	25003-1493	23	2.250	3.250	0.438	57	83	11
25003-1229	23	5.094	6.586	0.484	129	167	12	25003-1494	23	2.250	3.250	0.500	57	83	13
25003-1235	23	8.937	10.500	0.750	227	267	19	25003-1515	23	3.625	4.609	0.492	92	117	12
25003-1237	23-L	18.110	20.079	0.787	460	510	20	25003-1524	23	6.125	7.307	0.591	156	186	15
25003-1242	23-L	13.000	14.606	0.703	330	371	18	25003-1586	23	3.250	4.225	0.375	83	107	10
25003-1246	23	10.984	12.165	0.591	279	309	15	25003-1592	23	8.437	9.938	0.750	214	252	19
25003-1248	23	4.813	6.007	0.375	122	153	10	25003-1608	23-L	15.354	16.535	0.551	390	420	14
25003-1250	23	5.438	6.720	0.625	138	171	16	25003-1616	23	7.087	8.071	0.512	180	205	13
25003-1255	23	2.062	2.997	0.390	52	76	10	25003-1617	23-L	14.750	16.500	0.813	375	419	21
25003-1256	23	2.938	3.906	0.484	75	99	12	25003-1622	23-L	40.533	42.283	0.875	1030	1074	22
25003-1259	23	4.921	5.906	0.591	125	150	15	25003-1623	23	10.750	12.688	0.578	273	322	15
25003-1269	23	6.102	7.087	0.500	155	180	13	25003-1625	23	4.500	5.688	0.625	114	144	16
25003-1275	23-L	45.000	46.750	0.875	1143	1187	22	25003-1628	23	3.312	4.250	0.500	84	108	13
25003-1277	23	4.500	5.688	0.500	114	144	13	25003-1634	23-L	42.992	44.492	0.750	1092	1130	19
25003-1280	23-L	16.299	18.268	0.811	414	464	21	25003-1642	23	2.375	3.125	0.375	60	79	10
25003-1283	23	9.750	11.375	0.750	248	289	19	25003-1657	23	2.375	3.350	0.375	60	85	10
25003-1288	23	7.813	9.000	0.625	198	229	16	25003-1664	23	4.500	5.750	0.438	114	146	11
25003-1289	23-L	33.625	35.594	0.938	854	904	24	25003-1665	23	5.125	6.500	0.375	130	165	10
25003-1292	23	10.236	12.125	0.787	260	308	20	25003-1682	23	5.500	6.375	0.500	140	162	13
25003-1294	23-L	23.900	25.100	0.750	607	638	19	25003-1688	23-L	15.161	16.885	0.813	385	429	21
25003-1296	23	3.500	4.437	0.500	89	113	13	25003-1690	23	7.480	8.729	0.625	190	222	16
25003-1298	23-L	19.291	21.260	0.787	490	540	20	25003-1694	23	8.750	9.764	0.375	222	248	10
25003-1303	23	4.724	6.101	0.500	120	155	13	25003-1695	23-L	32.688	33.938	0.500	830	862	13
25003-1304	23-L	12.500	14.375	0.750	318	365	19	25003-1697	23-L	75.000	76.500	0.750	1905	1943	19
25003-1305	23-L	22.500	23.375	0.375	572	594	10	25003-1701	23-L	32.835	33.938	0.500	834	862	13
25003-1308	23	7.375	8.500	0.500	187	216	13	25003-1703	23	9.844	11.342	0.748	250	298	19
25003-1310	23	12.000	12.875	0.375	305	327	10	25003-1706	23	6.063	7.087	0.413	154	180	10
25003-1311	23-L	22.875	23.750	0.375	581	603	10	25003-1707	23	4.882	6.299	0.413	124	160	10
25003-1312	23-L	26.875	27.750	0.375	683	705	10	25003-1709	23	6.889	7.875	0.472	175	200	12
25003-1335	23	2.125	3.125	0.500	54	79	13	25003-1712	23-L	12.598	14.173	0.748	320	360	19
25003-1374	23	5.906	7.906	0.500	150	201	13	25003-1713	23	3.750	4.732	0.405	95	120	10
25003-1379	23	7.480	8.661	0.630	190	220	16	25003-1717	23	6.299	7.875	0.472	160	200	12
25003-1388	23	6.890	8.465	0.625	175	215	16	25003-1718	23	5.511	6.693	0.472	140	170	12
25003-1391	23	6.298	7.500	0.375	160	191	10	25003-1719	23-L	25.197	27.165	0.807	640	690	21
25003-1392	23	8.661	10.236	0.787	220	260	20	25003-1728	23-L	36.500	39.000	0.750	927	991	19
25003-1393	23	6.062	7.500	0.750	154	191	19	25003-1730	23-L	34.000	36.500	0.750	864	927	19
25003-1394	23	6.299	7.244	0.551	160	184	14	25003-1733	23-L	57.000	59.000	0.828	1448	1499	21
25003-1395	23	6.693	7.638	0.551	170	194	14	25003-1734	23	7.187	8.437	0.500	183	214	13
25003-1397	23	4.921	6.299	0.709	125	160	18	25003-1735	23	2.438	3.250	0.375	62	83	10
25003-1439	23-L	15.938	17.437	0.750	405	443	19	25003-1736	23	2.437	3.313	0.375	62	84	10
25003-1440	23	3.437	4.500	0.437	87	114	11	25003-1746	23	3.938	4.906	0.484	100	125	12
25003-1441	23	9.875	11.375	0.625	251	289	16	25003-1749	23	2.438	3.500	0.500	62	89	13
25003-1444	23	3.500	4.475	0.500	89	114	13	25003-1766	23	3.938	4.906	0.484	100	125	12
25003-1448	23	3.938	5.000	0.400	100	127	10	25003-1767	23-L	15.354	17.086	0.787	390	434	20
25003-1449	23-L	15.438	16.938	0.750	392	430	19	25003-1768	23	3.465	4.729	0.500	88	120	13
25003-1453	23-L	55.125	58.000	0.750	1400	1473	19	25003-1769	23-L	13.125	15.000	0.750	333	381	19
25003-1454	23-L	14.875	16.875	0.375	378	429	10	25003-1770	23	8.000	9.450	0.625	203	240	16

All dimensions are in inches. Preferred sizes are indicated with **bold** type face. Sizes listed are for standard nitrile elements, except Models 25 and 62 which have PTFE elements. Other material available on inquiry only.

## Oil Seals by Model Number

Product Code	Model	Inches			MM			Product Code	Model	Inches			MM		
		ID	OD	Width	ID	OD	Width			ID	OD	Width	ID	OD	Width
25003-1772	23	3.464	4.331	0.500	88	110	13	25003-2021	23-L	17.500	18.750	0.500	445	476	13
25003-1777	23	5.438	6.750	0.750	138	171	19	25003-2022	23	5.305	6.305	0.500	135	160	13
25003-1780	23-L	19.625	21.125	0.500	498	537	13	25003-2024	23	4.910	5.910	0.500	125	150	13
25003-1781	23	12.125	13.125	0.500	308	333	13	25003-2026	23-L	14.580	16.200	0.625	370	411	16
25003-1782	23	11.188	13.000	0.750	284	330	19	25003-2030	23	2.750	4.000	0.500	70	102	13
25003-1804	23	2.500	3.246	0.375	64	82	10	25003-2035	23	2.750	3.500	0.375	70	89	10
25003-1807	23	2.500	3.250	0.375	64	83	10	25003-2044	23	2.750	3.751	0.375	70	95	10
25003-1819	23	2.500	3.500	0.375	64	89	10	25003-2054	23	2.750	3.625	0.438	70	92	11
25003-1820	23	2.500	3.500	0.437	64	89	11	25003-2057	23	2.750	3.750	0.375	70	95	10
25003-1821	23	2.500	3.500	0.500	64	89	13	25003-2058	23-L	21.250	23.250	0.750	540	591	19
25003-1832	23	6.500	7.500	0.375	165	191	10	25003-2064	23	7.010	8.510	0.500	178	216	13
25003-1844	23	2.625	3.625	0.500	67	92	13	25003-2065	23	7.256	8.756	0.500	184	222	13
25003-1868	23	7.250	8.703	0.609	184	221	15	25003-2066	23-L	14.174	15.354	0.709	360	390	18
25003-1869	23	6.889	7.889	0.500	175	200	13	25003-2067	23-L	14.750	16.125	0.750	375	410	19
25003-1872	23-L	57.000	59.000	0.813	1448	1499	21	25003-2068	23	10.000	11.000	0.375	254	279	10
25003-1875	23	3.938	4.921	0.492	100	125	12	25003-2069	23-L	15.748	17.717	0.788	400	450	20
25003-1877	23-L	38.000	40.000	1.000	965	1016	25	25003-2079	23-L	29.528	32.047	0.750	750	814	19
25003-1881	23	10.000	11.875	0.813	254	302	21	25003-2081	23	7.283	8.283	0.500	185	210	13
25003-1885	23	2.563	3.500	0.375	65	89	10	25003-2095	23	3.681	5.000	0.500	93	127	13
25003-1894	23	2.562	3.751	0.375	65	95	10	25003-2105	23	2.953	4.213	0.492	75	107	12
25003-1901	23	3.681	4.681	0.500	93	119	13	25003-2106	23	7.625	8.500	0.515	194	216	13
25003-1905	23	11.000	13.000	0.500	279	330	13	25003-2108	23	3.063	4.000	0.500	78	102	13
25003-1907	23-L	49.500	51.325	0.850	1257	1304	22	25003-2109	23-L	13.780	15.512	0.500	350	394	13
25003-1908	23	10.125	11.500	0.625	257	292	16	25003-2110	23	2.875	3.625	0.375	73	92	10
25003-1911	23-L	20.866	22.835	0.787	530	580	20	25003-2115	23	2.875	3.623	0.375	73	92	10
25003-1918	23-L	15.250	16.250	0.500	387	413	13	25003-2118	23	2.875	3.750	0.375	73	95	10
25003-1923	23-L	17.000	18.250	0.750	432	464	19	25003-2121	23	2.875	3.875	0.375	73	98	10
25003-1939	23	2.625	3.500	0.375	67	89	10	25003-2137	23	3.346	4.331	0.492	85	110	12
25003-1941	23	2.625	3.500	0.500	67	89	13	25003-2144	23-L	72.500	74.000	0.750	1842	1880	19
25003-1942	23	2.625	3.543	0.375	67	90	10	25003-2146	23	2.938	3.750	0.375	75	95	10
25003-1949	23	7.879	8.859	0.591	200	225	15	25003-2149	23	2.938	3.875	0.375	75	98	10
25003-1953	23	8.465	9.646	0.493	215	245	13	25003-2152	23	2.938	4.003	0.375	75	102	10
25003-1957	23-L	39.000	41.500	0.750	991	1054	19	25003-2153	23	2.938	4.003	0.437	75	102	11
25003-1958	23	2.625	3.625	0.375	67	92	10	25003-2156	23	7.812	9.250	0.500	198	235	13
25003-1959	23-L	30.709	32.283	0.709	780	820	18	25003-2158	23-L	28.625	30.625	0.813	727	778	21
25003-1960	23	12.875	13.875	0.500	327	352	13	25003-2159	23	5.500	6.750	0.687	140	171	17
25003-1961	23	5.500	6.875	0.563	140	175	14	25003-2168	23	3.000	3.751	0.375	76	95	10
25003-1962	23	11.024	12.520	0.709	280	318	18	25003-2171	23	3.000	3.875	0.375	76	98	10
25003-1963	23	9.000	10.500	0.563	229	267	14	25003-2173	23	3.000	3.875	0.500	76	98	13
25003-1965	23	7.438	8.500	0.500	189	216	13	25003-2174	23	3.000	4.003	0.375	76	102	10
25003-1970	23	6.496	7.875	0.591	165	200	15	25003-2176	23	3.000	4.003	0.500	76	102	13
25003-1971	23	10.500	12.500	0.500	267	318	13	25003-2177	23	3.000	4.125	0.500	76	105	13
25003-1976	23-L	17.000	18.000	0.500	432	457	13	25003-2183	23	3.000	4.375	0.500	76	111	13
25003-1977	23-L	24.375	25.625	0.625	619	651	16	25003-2185	23-L	12.750	14.250	0.812	324	362	21
25003-1979	23	3.937	5.118	0.472	100	130	12	25003-2186	23	3.000	4.500	0.500	76	114	13
25003-1980	23	10.500	11.906	0.766	267	302	19	25003-2193	23-L	18.000	19.438	0.500	457	494	13
25003-1982	23	10.875	12.875	0.500	276	327	13	25003-2196	23-L	24.640	25.640	0.500	626	651	13
25003-1983	23-L	41.125	43.125	1.000	1045	1095	25	25003-2200	23	3.063	4.063	0.500	78	103	13
25003-1984	23	12.500	13.375	0.500	318	340	13	25003-2201	23	3.063	4.125	0.500	78	105	13
25003-1986	23	3.228	4.102	0.375	82	104	10	25003-2205	23-L	68.000	70.000	1.000	1727	1778	25
25003-1988	23	3.563	4.563	0.375	91	116	10	25003-2206	23-L	15.512	16.536	0.500	394	420	13
25003-1997	23-L	25.625	26.875	0.625	651	683	16	25003-2214	23	3.346	4.331	0.472	85	110	12
25003-1998	23	3.150	4.331	0.500	80	110	13	25003-2225	23	3.125	4.125	0.500	79	105	13
25003-2000	23	4.134	5.118	0.500	105	130	13	25003-2228	23	3.125	4.249	0.500	79	108	13
25003-2013	23	2.688	3.881	0.469	68	99	12	25003-2231	23	3.125	4.375	0.500	79	111	13
25003-2019	23	5.512	6.496	0.492	140	165	12	25003-2233	23	5.906	7.480	0.591	150	190	15

All dimensions are in inches. Preferred sizes are indicated with **bold** type face.

Sizes listed are for standard nitrile elements, except Models 25 and 62 which have PTFE elements. Other material available on inquiry only.

## Oil Seals by Model Number

Product Code	Model	Inches			MM			Product Code	Model	Inches			MM		
		ID	OD	Width	ID	OD	Width			ID	OD	Width	ID	OD	Width
25003-2234	23	3.125	4.500	0.500	79	114	13	25003-2389	23-L	15.748	17.717	0.709	400	450	18
25003-2244	23	8.875	10.250	0.750	225	260	19	25003-2391	23	7.750	9.000	0.750	197	229	19
25003-2245	23-L	13.386	15.118	0.787	340	384	20	25003-2393	23	3.563	4.625	0.500	91	117	13
25003-2247	23	8.858	10.433	0.630	225	265	16	25003-2395	23	12.125	13.375	0.750	308	340	19
25003-2248	23-L	26.378	27.874	0.748	670	708	19	25003-2396	23	3.563	4.750	0.500	91	121	13
25003-2249	23	3.188	4.249	0.500	81	108	13	25003-2409	23	5.500	6.750	0.575	140	171	15
25003-2252	23	3.188	4.375	0.500	81	111	13	25003-2415	23	3.625	5.000	0.500	92	127	13
25003-2255	23	3.188	4.500	0.500	81	114	13	25003-2417	23	3.625	4.625	0.500	92	117	13
25003-2256	23	9.646	11.142	0.812	245	283	21	25003-2420	23	3.625	4.750	0.500	92	121	13
25003-2259	23	3.897	4.876	0.500	99	124	13	25003-2423	23	3.625	4.875	0.500	92	124	13
25003-2265	23-L	40.265	41.765	0.770	1023	1061	20	25003-2426	23	3.625	5.000	0.500	92	127	13
25003-2269	23	6.375	7.250	0.515	162	184	13	25003-2429	23	3.625	5.125	0.500	92	130	13
25003-2270	23	3.250	4.249	0.500	83	108	13	25003-2439	23-L	19.688	21.688	0.812	500	551	21
25003-2273	23	3.250	4.375	0.500	83	111	13	25003-2441	23	3.688	4.750	0.500	94	121	13
25003-2274	23	5.125	6.000	0.500	130	152	13	25003-2444	23	3.688	4.875	0.500	94	124	13
25003-2275	23-L	15.748	17.717	0.812	400	450	21	25003-2447	23	3.687	4.999	0.500	94	127	13
25003-2276	23	3.250	4.500	0.500	83	114	13	25003-2452	23-L	34.480	36.480	0.812	876	927	21
25003-2279	23	3.250	4.625	0.500	83	117	13	25003-2454	23	12.205	13.937	0.787	310	354	20
25003-2282	23	3.250	4.750	0.500	83	121	13	25003-2457	23	6.890	8.071	0.591	175	205	15
25003-2286	23-L	13.386	15.157	0.802	340	385	20	25003-2458	23	10.357	11.500	0.625	263	292	16
25003-2293	23	4.921	6.299	0.512	125	160	13	25003-2462	23	3.750	4.750	0.500	95	121	13
25003-2294	23	3.916	5.234	0.500	99	133	13	25003-2465	23	3.750	4.875	0.500	95	124	13
25003-2297	23	3.313	4.375	0.500	84	111	13	25003-2468	23	3.750	4.999	0.500	95	127	13
25003-2298	23	3.500	4.500	0.438	89	114	11	25003-2471	23	3.750	5.125	0.500	95	130	13
25003-2300	23	3.313	4.500	0.500	84	114	13	25003-2472	23-L	12.250	14.000	0.625	311	356	16
25003-2301	23	3.313	4.500	0.469	84	114	12	25003-2474	23	3.750	5.250	0.500	95	133	13
25003-2308	23-L	52.185	54.190	0.812	1325	1376	21	25003-2475	23-L	61.417	63.417	0.812	1560	1611	21
25003-2313	23-L	27.500	29.500	0.750	699	749	19	25003-2477	23-L	44.094	46.063	0.812	1120	1170	21
25003-2314	23	10.236	12.244	0.748	260	311	19	25003-2483	23	3.813	4.875	0.500	97	124	13
25003-2319	23-L	12.750	14.482	0.787	324	368	20	25003-2484	23-L	19.685	21.457	0.787	500	545	20
25003-2321	23	3.375	4.375	0.500	86	111	13	25003-2485	23	9.055	10.180	0.494	230	259	13
25003-2322	23-L	20.000	20.938	0.500	508	532	13	25003-2486	23	3.813	5.000	0.500	97	127	13
25003-2324	23	3.375	4.500	0.500	86	114	13	25003-2491	23-L	16.187	17.437	0.750	411	443	19
25003-2327	23	3.375	4.625	0.500	86	117	13	25003-2493	23	3.938	5.000	0.438	100	127	11
25003-2328	23-L	14.961	16.535	0.625	380	420	16	25003-2496	23	4.803	5.906	0.500	122	150	13
25003-2330	23	3.375	4.750	0.500	86	121	13	25003-2497	23-L	12.750	14.750	0.812	324	375	21
25003-2331	23	2.953	4.213	0.500	75	107	13	25003-2499	23-L	17.400	19.400	0.812	442	493	21
25003-2333	23	3.375	4.875	0.500	86	124	13	25003-2500	23	7.874	9.374	0.752	200	238	19
25003-2337	23-L	18.750	20.250	0.500	476	514	13	25003-2501	23	3.875	4.875	0.500	98	124	13
25003-2341	23	5.906	7.087	0.630	150	180	16	25003-2505	23-L	20.000	21.250	0.625	508	540	16
25003-2343	23	9.625	11.000	0.750	244	279	19	25003-2507	23	3.875	5.125	0.500	98	130	13
25003-2344	23	10.000	11.640	0.750	254	296	19	25003-2509	23-L	25.000	26.875	0.750	635	683	19
25003-2345	23	3.438	4.500	0.500	87	114	13	25003-2510	23	3.875	5.250	0.500	98	133	13
25003-2348	23	3.438	4.625	0.500	87	117	13	25003-2513	23	3.875	5.375	0.500	98	137	13
25003-2350	23	10.827	12.205	0.591	275	310	15	25003-2515	23	3.188	4.249	0.438	81	108	11
25003-2351	23	3.438	4.750	0.500	87	121	13	25003-2517	23	7.687	8.687	0.500	195	221	13
25003-2352	23	10.000	11.375	0.500	254	289	13	25003-2518	23	4.987	6.000	0.500	127	152	13
25003-2355	23	4.187	5.312	0.500	106	135	13	25003-2519	23	3.938	5.000	0.500	100	127	13
25003-2358	23	3.125	4.500	0.438	79	114	11	25003-2522	23	3.938	5.125	0.500	100	130	13
25003-2364	23	3.500	4.375	0.375	89	111	10	25003-2523	23	3.938	4.938	0.438	100	125	11
25003-2366	23	3.500	4.500	0.500	89	114	13	25003-2525	23	3.938	5.250	0.500	100	133	13
25003-2369	23	3.500	4.625	0.500	89	117	13	25003-2528	23	3.938	5.376	0.500	100	137	13
25003-2372	23	3.500	4.750	0.500	89	121	13	25003-2530	23	9.500	10.937	0.750	241	278	19
25003-2376	23	10.500	11.500	0.375	267	292	10	25003-2533	23	4.016	5.438	0.500	102	138	13
25003-2383	23-L	13.500	14.919	0.700	343	379	18	25003-2537	23	4.000	4.999	0.500	102	127	13
25003-2385	23	3.238	4.180	0.500	82	106	13	25003-2540	23	4.000	5.125	0.500	102	130	13

All dimensions are in inches. Preferred sizes are indicated with **bold** type face. Sizes listed are for standard nitrile elements, except Models 25 and 62 which have PTFE elements. Other material available on inquiry only.

## Oil Seals by Model Number

Product Code	Model	Inches			MM			Product Code	Model	Inches			MM		
		ID	OD	Width	ID	OD	Width			ID	OD	Width	ID	OD	Width
25003-2543	23	4.000	5.250	0.500	102	133	13	25003-2663	23	4.250	5.500	0.500	108	140	13
25003-2546	23	4.000	5.375	0.500	102	137	13	25003-2666	23	4.250	5.625	0.500	108	143	13
25003-2548	23	3.938	5.125	0.468	100	130	12	25003-2669	23	4.250	5.750	0.500	108	146	13
25003-2549	23	4.000	5.500	0.500	102	140	13	25003-2674	23-L	23.228	25.197	0.787	590	640	20
25003-2553	23	4.000	5.500	0.438	102	140	11	25003-2679	23	7.480	8.480	0.500	190	215	13
25003-2554	23	4.000	4.875	0.500	102	124	13	25003-2680	23	6.000	7.125	0.437	152	181	11
25003-2557	23	4.000	4.938	0.500	102	125	13	25003-2683	23-L	17.000	18.500	0.625	432	470	16
25003-2560	23	6.062	7.062	0.375	154	179	10	25003-2684	23	4.312	5.375	0.500	110	137	13
25003-2565	23	3.000	4.000	0.406	76	102	10	25003-2685	23	3.125	4.188	0.500	79	106	13
25003-2570	23	4.062	5.125	0.500	103	130	13	25003-2686	23-L	45.500	47.000	0.750	1156	1194	19
25003-2572	23	5.315	6.693	0.500	135	170	13	25003-2687	23	4.313	5.500	0.500	110	140	13
25003-2573	23	4.062	5.250	0.500	103	133	13	25003-2688	23	7.600	8.894	0.750	193	226	19
25003-2575	23	7.937	9.250	0.625	202	235	16	25003-2689	23	4.313	5.500	0.625	110	140	16
25003-2578	23	4.250	5.062	0.375	108	129	10	25003-2690	23	4.313	5.625	0.500	110	143	13
25003-2579	23	4.062	5.500	0.500	103	140	13	25003-2691	23	4.313	5.501	0.438	110	140	11
25003-2580	23	9.375	11.250	0.750	238	286	19	25003-2696	23	4.313	5.313	0.438	110	135	11
25003-2581	23	7.480	8.465	0.500	190	215	13	25003-2697	23-L	18.449	19.449	0.500	469	494	13
25003-2582	23	11.024	12.205	0.630	280	310	16	25003-2700	23-L	14.394	15.394	0.500	366	391	13
25003-2597	23	8.465	9.843	0.591	215	250	15	25003-2703	23-L	50.000	52.250	0.750	1270	1327	19
25003-2598	23	8.214	9.464	0.500	209	240	13	25003-2704	23	11.750	13.562	0.500	298	344	13
25003-2600	23	4.125	5.125	0.500	105	130	13	25003-2707	23-L	26.625	28.125	0.750	676	714	19
25003-2603	23	4.125	5.250	0.500	105	133	13	25003-2708	23	4.375	5.375	0.500	111	137	13
25003-2606	23	4.125	5.375	0.500	105	137	13	25003-2709	23-L	25.375	26.875	0.562	645	683	14
25003-2607	23-L	15.157	16.890	0.787	385	429	20	25003-2711	23	4.375	5.500	0.500	111	140	13
25003-2609	23	4.125	5.500	0.500	105	140	13	25003-2714	23	4.375	5.625	0.500	111	143	13
25003-2612	23	4.125	5.625	0.500	105	143	13	25003-2717	23	4.375	5.750	0.500	111	146	13
25003-2613	23	10.433	11.417	0.625	265	290	16	25003-2719	23	4.625	6.095	0.500	117	155	13
25003-2614	23	7.625	9.188	0.625	194	233	16	25003-2720	23	4.375	5.875	0.500	111	149	13
25003-2615	23	8.750	10.312	0.625	222	262	16	25003-2721	23	8.970	10.500	0.500	228	267	13
25003-2617	23	2.563	3.438	0.375	65	87	10	25003-2724	23	4.375	6.000	0.563	111	152	14
25003-2619	23-L	15.625	17.625	0.812	397	448	21	25003-2727	23	8.375	9.875	0.375	213	251	10
25003-2620	23-L	19.625	21.080	0.500	498	535	13	25003-2728	23-L	19.250	20.250	0.500	489	514	13
25003-2621	23	4.125	6.000	0.500	105	152	13	25003-2732	23	4.438	5.500	0.500	113	140	13
25003-2622	23	3.938	4.950	0.500	100	126	13	25003-2734	23-L	14.188	16.188	0.750	360	411	19
25003-2623	23-L	55.906	57.874	0.812	1420	1470	21	25003-2735	23	4.438	5.625	0.500	113	143	13
25003-2624	23	5.500	6.375	0.437	140	162	11	25003-2738	23	4.438	5.750	0.500	113	146	13
25003-2625	23-L	16.535	17.913	0.787	420	455	20	25003-2744	23	4.438	6.000	0.500	113	152	13
25003-2628	23-L	26.750	28.563	0.813	679	726	21	25003-2745	23	4.438	6.000	0.563	113	152	14
25003-2630	23	4.188	5.250	0.500	106	133	13	25003-2750	23	4.438	6.250	0.500	113	159	13
25003-2632	23	3.187	4.447	0.500	81	113	13	25003-2753	23	4.500	5.500	0.500	114	140	13
25003-2633	23	4.188	5.375	0.500	106	137	13	25003-2756	23	4.500	5.625	0.500	114	143	13
25003-2634	23	4.724	5.708	0.500	120	145	13	25003-2759	23	4.500	5.750	0.500	114	146	13
25003-2635	23	4.187	5.375	0.625	106	137	16	25003-2760	23	4.500	5.750	0.562	114	146	14
25003-2636	23	4.188	5.500	0.500	106	140	13	25003-2762	23	4.500	5.875	0.500	114	149	13
25003-2640	23-L	16.530	17.854	0.500	420	453	13	25003-2763	23	4.500	5.750	0.375	114	146	10
25003-2641	23	4.188	5.188	0.500	106	132	13	25003-2764	23-L	29.000	31.000	1.000	737	787	25
25003-2643	23	7.283	8.464	0.590	185	215	15	25003-2765	23	4.500	6.000	0.500	114	152	13
25003-2644	23	4.188	5.250	0.469	106	133	12	25003-2773	23-L	33.858	35.858	0.813	860	911	21
25003-2646	23	11.500	13.125	0.812	292	333	21	25003-2774	23	4.500	6.375	0.500	114	162	13
25003-2647	23	8.250	9.688	0.750	210	246	19	25003-2775	23-L	21.000	22.760	0.750	533	578	19
25003-2652	23-L	20.375	22.188	0.812	518	564	21	25003-2777	23	4.563	5.625	0.500	116	143	13
25003-2653	23-L	20.500	22.000	0.625	521	559	16	25003-2780	23	4.563	5.750	0.500	116	146	13
25003-2655	23	10.438	12.000	0.625	265	305	16	25003-2781	23-L	16.500	17.875	0.750	419	454	19
25003-2657	23	4.250	5.250	0.500	108	133	13	25003-2786	23	4.563	6.000	0.500	116	152	13
25003-2658	23	4.250	5.250	0.563	108	133	14	25003-2790	23	4.494	5.925	0.500	114	150	13
25003-2660	23	4.250	5.375	0.500	108	137	13	25003-2791	23	10.688	12.250	0.625	271	311	16

All dimensions are in inches. Preferred sizes are indicated with **bold** type face.

Sizes listed are for standard nitrile elements, except Models 25 and 62 which have PTFE elements. Other material available on inquiry only.

## Oil Seals by Model Number

Product Code	Model	Inches			MM			Product Code	Model	Inches			MM		
		ID	OD	Width	ID	OD	Width			ID	OD	Width	ID	OD	Width
25003-2792	23	4.563	6.250	0.500	116	159	13	25003-2928	23	5.000	6.500	0.563	127	165	14
25003-2793	23	5.938	7.438	0.500	151	189	13	25003-2931	23	4.408	5.500	0.500	112	140	13
25003-2794	23-L	32.156	34.250	0.750	817	870	19	25003-2932	23	10.437	11.937	0.625	265	303	16
25003-2796	23-L	28.740	31.260	0.748	730	794	19	25003-2937	23	8.750	10.000	0.375	222	254	10
25003-2798	23	4.625	5.625	0.500	117	143	13	25003-2938	23	4.186	5.186	0.500	106	132	13
25003-2801	23	4.625	5.750	0.500	117	146	13	25003-2940	23	11.417	13.150	0.787	290	334	20
25003-2804	23	4.625	5.875	0.500	117	149	13	25003-2943	23	3.437	4.875	0.437	87	124	11
25003-2807	23	4.625	6.000	0.500	117	152	13	25003-2947	23-L	29.449	31.496	0.787	748	800	20
25003-2808	23-L	16.110	18.110	0.787	409	460	20	25003-2954	23	5.063	6.125	0.500	129	156	13
25003-2810	23	4.625	6.125	0.500	117	156	13	25003-2958	23	5.875	6.812	0.500	149	173	13
25003-2813	23	4.625	6.250	0.500	117	159	13	25003-2960	23	5.875	6.750	0.500	149	171	13
25003-2816	23	4.438	5.875	0.500	113	149	13	25003-2966	23	2.953	3.938	0.375	75	100	10
25003-2819	23	4.688	5.750	0.500	119	146	13	25003-2974	23	5.000	5.875	0.500	127	149	13
25003-2822	23	4.688	5.875	0.500	119	149	13	25003-2975	23	3.375	4.500	0.438	86	114	11
25003-2826	23	6.693	7.875	0.472	170	200	12	25003-2980	23-L	13.750	15.250	0.500	349	387	13
25003-2828	23	7.087	8.268	0.472	180	210	12	25003-2983	23	6.750	8.000	0.375	171	203	10
25003-2829	23	8.661	9.844	0.472	220	250	12	25003-2985	23	4.000	5.625	0.375	102	143	10
25003-2833	23	8.268	9.449	0.472	210	240	12	25003-2987	23	4.375	5.817	0.500	111	148	13
25003-2837	23	4.750	5.750	0.500	121	146	13	25003-2988	23	5.118	6.299	0.591	130	160	15
25003-2840	23	4.750	5.875	0.500	121	149	13	25003-2990	23	5.125	6.125	0.500	130	156	13
25003-2843	23	4.750	6.000	0.500	121	152	13	25003-2993	23	5.125	6.250	0.500	130	159	13
25003-2846	23	4.750	6.125	0.500	121	156	13	25003-2994	23	5.125	6.250	0.563	130	159	14
25003-2849	23	4.750	6.250	0.500	121	159	13	25003-2996	23	5.125	6.375	0.500	130	162	13
25003-2855	23	4.813	5.875	0.500	122	149	13	25003-2997	23	5.125	6.375	0.563	130	162	14
25003-2858	23	4.813	6.000	0.500	122	152	13	25003-2998	23	5.125	6.375	0.625	130	162	16
25003-2861	23	4.813	6.125	0.500	122	156	13	25003-2999	23	5.125	6.500	0.500	130	165	13
25003-2866	23	7.480	8.677	0.500	190	220	13	25003-3001	23	5.125	6.500	0.625	130	165	16
25003-2870	23	4.875	5.875	0.500	124	149	13	25003-3007	23	8.375	9.750	0.625	213	248	16
25003-2873	23	4.875	6.000	0.500	124	152	13	25003-3009	23-L	13.779	15.354	0.709	350	390	18
25003-2875	23	4.875	6.000	0.625	124	152	16	25003-3012	23	4.309	5.348	0.375	109	136	10
25003-2876	23	4.875	6.125	0.500	124	156	13	25003-3014	23	11.417	13.189	0.812	290	335	21
25003-2879	23	4.875	6.250	0.500	124	159	13	25003-3015	23-L	16.535	18.504	0.812	420	470	21
25003-2880	23	4.875	6.250	0.563	124	159	14	25003-3020	23-L	21.260	23.228	0.787	540	590	20
25003-2882	23	4.875	6.375	0.500	124	162	13	25003-3026	23	5.188	6.250	0.500	132	159	13
25003-2887	23	4.921	5.906	0.472	125	150	12	25003-3029	23	5.188	6.375	0.500	132	162	13
25003-2890	23	6.063	7.063	0.390	154	179	10	25003-3030	23-L	16.929	18.898	0.812	430	480	21
25003-2893	23	4.938	5.938	0.438	125	151	11	25003-3032	23	5.188	6.500	0.500	132	165	13
25003-2894	23	4.938	6.000	0.500	125	152	13	25003-3036	23-L	13.625	14.500	0.375	346	368	10
25003-2900	23	4.938	6.250	0.500	125	159	13	25003-3037	23	7.874	9.055	0.472	200	230	12
25003-2903	23	4.938	6.375	0.500	125	162	13	25003-3042	23	8.858	10.039	0.591	225	255	15
25003-2904	23	4.938	6.375	0.563	125	162	14	25003-3053	23-L	20.472	22.472	0.811	520	571	21
25003-2907	23-L	29.750	31.750	0.875	756	806	22	25003-3058	23	3.740	5.118	0.500	95	130	13
25003-2910	23	4.938	5.875	0.500	125	149	13	25003-3059	23	5.250	6.250	0.500	133	159	13
25003-2911	23-L	12.598	14.331	0.787	320	364	20	25003-3060	23	4.677	5.661	0.492	119	144	12
25003-2913	23	10.438	11.500	0.625	265	292	16	25003-3062	23	5.250	6.375	0.500	133	162	13
25003-2914	23	9.250	10.500	0.375	235	267	10	25003-3065	23	5.250	6.500	0.500	133	165	13
25003-2915	23	5.000	6.000	0.500	127	152	13	25003-3066	23-L	18.375	19.375	0.500	467	492	13
25003-2918	23	5.000	6.125	0.500	127	156	13	25003-3067	23	5.250	6.500	0.625	133	165	16
25003-2919	23	5.000	6.125	0.563	127	156	14	25003-3068	23	5.250	6.625	0.500	133	168	13
25003-2921	23	5.000	6.250	0.500	127	159	13	25003-3069	23	11.811	13.811	0.750	300	351	19
25003-2922	23	5.000	6.250	0.562	127	159	14	25003-3071	23	5.250	6.750	0.500	133	171	13
25003-2923	23	5.000	6.250	0.625	127	159	16	25003-3072	23	11.339	12.839	0.750	288	326	19
25003-2924	23	5.000	6.375	0.500	127	162	13	25003-3073	23	5.250	6.750	0.625	133	171	16
25003-2925	23	4.313	5.563	0.500	110	141	13	25003-3074	23	3.500	4.501	0.468	89	114	12
25003-2926	23	5.000	6.375	0.625	127	162	16	25003-3078	23	6.693	8.268	0.472	170	210	12
25003-2927	23	5.000	6.500	0.500	127	165	13	25003-3082	23	2.353	3.228	0.474	60	82	12

All dimensions are in inches. Preferred sizes are indicated with **bold** type face. Sizes listed are for standard nitrile elements, except Models 25 and 62 which have PTFE elements. Other material available on inquiry only.



## Oil Seals by Model Number

Product Code	Model	Inches			MM			Product Code	Model	Inches			MM		
		ID	OD	Width	ID	OD	Width			ID	OD	Width	ID	OD	Width
25003-3083	23-L	33.000	35.000	0.750	838	889	19	25003-3195	23	9.125	10.125	0.375	232	257	10
25003-3089	23	8.976	10.630	0.630	228	270	16	25003-3196	23	6.000	7.406	0.588	152	188	15
25003-3090	23	5.302	6.302	0.500	135	160	13	25003-3197	23	5.708	7.086	0.630	145	180	16
25003-3091	23-L	15.000	16.375	0.531	381	416	13	25003-3198	23	10.250	11.500	0.500	260	292	13
25003-3092	23	5.313	6.375	0.500	135	162	13	25003-3199	23	8.000	9.250	0.437	203	235	11
25003-3094	23	7.000	8.188	0.625	178	208	16	25003-3201	23	7.615	8.625	0.500	193	219	13
25003-3095	23	5.313	6.500	0.500	135	165	13	25003-3202	23-L	21.500	22.500	0.500	546	572	13
25003-3096	23	3.820	5.042	0.375	97	128	10	25003-3203	23	5.563	6.625	0.500	141	168	13
25003-3098	23	5.313	6.625	0.500	135	168	13	25003-3204	23	5.512	6.890	0.709	140	175	18
25003-3105	23	9.500	10.875	0.750	241	276	19	25003-3205	23-L	24.409	25.394	0.492	620	645	12
25003-3109	23	7.059	8.249	0.625	179	210	16	25003-3206	23	8.750	10.000	0.750	222	254	19
25003-3114	23-L	13.469	14.680	0.500	342	373	13	25003-3209	23-L	12.795	14.370	0.630	325	365	16
25003-3117	23	8.500	10.062	0.750	216	256	19	25003-3210	23-L	24.375	26.375	0.750	619	670	19
25003-3118	23	5.315	6.693	0.591	135	170	15	25003-3212	23	5.500	6.625	0.406	140	168	10
25003-3122	23	5.375	6.375	0.500	137	162	13	25003-3216	23	6.875	8.062	0.563	175	205	14
25003-3123	23	9.055	10.236	0.394	230	260	10	25003-3217	23	7.750	8.813	0.500	197	224	13
25003-3125	23	5.375	6.500	0.500	137	165	13	25003-3220	23-L	22.958	24.958	0.813	583	634	21
25003-3126	23	5.375	6.500	0.563	137	165	14	25003-3222	23-L	15.108	16.750	0.750	384	425	19
25003-3127	23	5.375	6.500	0.625	137	165	16	25003-3223	23-L	16.750	18.000	0.750	425	457	19
25003-3128	23	5.375	6.625	0.500	137	168	13	25003-3224	23-L	12.750	14.000	0.500	324	356	13
25003-3129	23	5.375	6.625	0.563	137	168	14	25003-3225	23	6.000	7.250	0.375	152	184	10
25003-3130	23	5.375	6.625	0.625	137	168	16	25003-3228	23	5.625	6.625	0.500	143	168	13
25003-3131	23	5.375	6.750	0.500	137	171	13	25003-3229	23	3.938	5.118	0.375	100	130	10
25003-3132	23	9.448	11.417	0.630	240	290	16	25003-3231	23	5.625	6.750	0.500	143	171	13
25003-3134	23	5.375	6.875	0.500	137	175	13	25003-3233	23	5.625	6.750	0.625	143	171	16
25003-3136	23	5.375	6.875	0.625	137	175	16	25003-3234	23	5.625	6.875	0.500	143	175	13
25003-3137	23	12.250	13.875	0.625	311	352	16	25003-3236	23	5.625	6.875	0.625	143	175	16
25003-3140	23-L	53.000	54.882	0.881	1346	1394	22	25003-3238	23-L	14.488	16.220	0.787	368	412	20
25003-3141	23-L	26.220	27.220	0.500	666	691	13	25003-3239	23	11.750	13.000	0.813	298	330	21
25003-3144	23	5.438	6.875	0.750	138	175	19	25003-3240	23	5.625	7.125	0.500	143	181	13
25003-3146	23	10.000	11.250	0.688	254	286	17	25003-3241	23	6.750	8.500	0.500	171	216	13
25003-3147	23-L	75.000	77.000	1.000	1905	1956	25	25003-3242	23-L	19.449	21.417	0.812	494	544	21
25003-3148	23	5.512	7.087	0.625	140	180	16	25003-3247	23-L	17.000	18.250	0.500	432	464	13
25003-3149	23-L	14.750	16.625	0.813	375	422	21	25003-3248	23	3.938	4.921	0.500	100	125	13
25003-3150	23	10.438	11.688	0.813	265	297	21	25003-3250	23-L	14.370	15.866	0.748	365	403	19
25003-3152	23	5.438	6.625	0.500	138	168	13	25003-3251	23	6.889	7.875	0.500	175	200	13
25003-3154	23	11.150	12.375	0.625	283	314	16	25003-3252	23	6.750	8.000	0.500	171	203	13
25003-3155	23	5.437	6.750	0.500	138	171	13	25003-3253	23	5.688	6.750	0.500	144	171	13
25003-3157	23	5.438	6.750	0.625	138	171	16	25003-3255	23	9.250	10.375	0.625	235	264	16
25003-3159	23	4.375	5.250	0.375	111	133	10	25003-3256	23	3.750	5.250	0.438	95	133	11
25003-3160	23	9.000	10.672	0.750	229	271	19	25003-3257	23	7.000	8.000	0.375	178	203	10
25003-3163	23	5.225	6.513	0.625	133	165	16	25003-3258	23	5.688	6.750	0.625	144	171	16
25003-3165	23-L	29.528	31.496	0.787	750	800	20	25003-3261	23	11.063	12.313	0.625	281	313	16
25003-3168	23	6.500	7.375	0.500	165	187	13	25003-3262	23-L	14.810	15.685	0.375	376	398	10
25003-3170	23-L	12.992	14.724	0.748	330	374	19	25003-3263	23	6.496	8.071	0.625	165	205	16
25003-3171	23	5.897	7.147	0.625	150	182	16	25003-3265	23	3.250	4.249	0.468	83	108	12
25003-3172	23	3.125	4.008	0.375	79	102	10	25003-3272	23	6.102	7.283	0.591	155	185	15
25003-3176	23	5.500	6.500	0.500	140	165	13	25003-3275	23	5.750	6.750	0.500	146	171	13
25003-3179	23	5.500	6.625	0.500	140	168	13	25003-3276	23	5.750	6.750	0.438	146	171	11
25003-3180	23	5.500	6.625	0.563	140	168	14	25003-3278	23	5.750	6.875	0.500	146	175	13
25003-3182	23	5.500	6.750	0.500	140	171	13	25003-3279	23	5.750	6.875	0.562	146	175	14
25003-3184	23	5.500	6.750	0.625	140	171	16	25003-3280	23	5.750	6.875	0.625	146	175	16
25003-3185	23	5.500	6.875	0.500	140	175	13	25003-3281	23	5.750	7.000	0.500	146	178	13
25003-3186	23-L	12.795	14.370	0.807	325	365	20	25003-3282	23	5.750	7.000	0.563	146	178	14
25003-3188	23	5.500	7.000	0.500	140	178	13	25003-3283	23	5.750	7.000	0.625	146	178	16
25003-3190	23	5.500	7.000	0.625	140	178	16	25003-3284	23	5.750	7.125	0.500	146	181	13

All dimensions are in inches. Preferred sizes are indicated with **bold** type face.

Sizes listed are for standard nitrile elements, except Models 25 and 62 which have PTFE elements. Other material available on inquiry only.

## Oil Seals by Model Number

Product Code	Model	Inches			MM			Product Code	Model	Inches			MM		
		ID	OD	Width	ID	OD	Width			ID	OD	Width	ID	OD	Width
25003-3286	23	8.625	10.000	0.625	219	254	16	25003-3405	23	6.250	7.750	0.750	159	197	19
25003-3287	23	5.750	7.250	0.500	146	184	13	25003-3406	23	6.375	7.375	0.500	162	187	13
25003-3288	23	5.750	7.500	0.563	146	191	14	25003-3408	23	8.000	9.500	0.375	203	241	10
25003-3293	23	5.750	7.500	0.500	146	191	13	25003-3409	23	6.375	7.500	0.500	162	191	13
25003-3302	23	6.469	7.469	0.500	164	190	13	25003-3412	23-L	17.625	19.125	0.750	448	486	19
25003-3303	23	5.875	6.750	0.625	149	171	16	25003-3413	23	6.375	7.625	0.500	162	194	13
25003-3307	23-L	26.375	28.188	0.812	670	716	21	25003-3415	23	6.375	7.625	0.625	162	194	16
25003-3316	23	5.875	6.875	0.500	149	175	13	25003-3417	23	6.375	7.750	0.500	162	197	13
25003-3319	23	5.875	7.000	0.500	149	178	13	25003-3419	23	6.375	7.500	0.625	162	191	16
25003-3324	23	5.875	7.125	0.625	149	181	16	25003-3421	23	6.375	7.875	0.500	162	200	13
25003-3325	23	5.875	7.250	0.500	149	184	13	25003-3423	23	6.375	7.875	0.625	162	200	16
25003-3327	23	5.906	7.087	0.591	150	180	15	25003-3424	23	6.375	7.875	0.750	162	200	19
25003-3328	23	5.875	7.375	0.500	149	187	13	25003-3425	23	6.438	7.750	0.750	164	197	19
25003-3330	23	5.875	7.375	0.625	149	187	16	25003-3426	23	6.500	7.500	0.625	165	191	16
25003-3332	23	5.875	7.500	0.563	149	191	14	25003-3427	23	2.313	3.194	0.500	59	81	13
25003-3333	23	4.450	5.500	0.500	113	140	13	25003-3428	23	6.500	7.625	0.625	165	194	16
25003-3335	23	5.938	7.000	0.500	151	178	13	25003-3429	23	2.165	3.150	0.394	55	80	10
25003-3336	23	3.470	4.470	0.375	88	114	10	25003-3430	23	6.500	7.750	0.625	165	197	16
25003-3338	23	5.938	7.125	0.500	151	181	13	25003-3431	23	6.500	7.750	0.750	165	197	19
25003-3343	23	5.938	7.250	0.625	151	184	16	25003-3432	23	6.500	7.875	0.625	165	200	16
25003-3344	23	5.938	7.375	0.500	151	187	13	25003-3433	23	5.500	7.193	0.625	140	183	16
25003-3347	23	5.938	7.500	0.500	151	191	13	25003-3434	23	6.500	8.000	0.625	165	203	16
25003-3348	23	3.935	4.960	0.500	100	126	13	25003-3435	23	6.500	8.000	0.750	165	203	19
25003-3351	23	5.938	7.625	0.500	151	194	13	25003-3436	23	6.625	7.625	0.625	168	194	16
25003-3355	23	6.000	7.000	0.500	152	178	13	25003-3438	23	6.625	7.750	0.625	168	197	16
25003-3357	23	6.000	7.000	0.625	152	178	16	25003-3439	23	3.500	4.631	0.500	89	118	13
25003-3359	23	6.000	7.125	0.563	152	181	14	25003-3440	23	6.625	7.875	0.625	168	200	16
25003-3360	23	6.000	7.125	0.625	152	181	16	25003-3442	23	6.625	8.000	0.625	168	203	16
25003-3361	23	6.000	7.250	0.500	152	184	13	25003-3444	23	6.625	8.125	0.625	168	206	16
25003-3363	23	6.000	7.250	0.625	152	184	16	25003-3445	23	6.625	8.125	0.750	168	206	19
25003-3364	23	6.000	7.375	0.500	152	187	13	25003-3446	23	6.625	8.250	0.625	168	210	16
25003-3366	23-L	28.000	29.250	0.625	711	743	16	25003-3452	23	3.750	4.625	0.500	95	117	13
25003-3367	23	6.000	7.500	0.500	152	191	13	25003-3455	23	6.750	7.750	0.438	171	197	11
25003-3369	23	6.000	7.500	0.625	152	191	16	25003-3456	23	6.750	7.750	0.625	171	197	16
25003-3370	23	6.000	7.500	0.750	152	191	19	25003-3458	23	6.750	7.875	0.625	171	200	16
25003-3373	23	6.000	7.625	0.625	152	194	16	25003-3459	23	6.750	7.875	0.375	171	200	10
25003-3375	23	6.125	7.125	0.500	156	181	13	25003-3460	23	6.750	8.000	0.625	171	203	16
25003-3376	23	6.063	7.063	0.438	154	179	11	25003-3462	23	6.750	8.125	0.625	171	206	16
25003-3378	23	6.125	7.250	0.500	156	184	13	25003-3463	23	7.500	9.008	0.750	191	229	19
25003-3379	23	3.937	5.197	0.492	100	132	12	25003-3464	23	6.750	8.250	0.625	171	210	16
25003-3380	23	6.125	7.250	0.625	156	184	16	25003-3465	23	6.750	8.250	0.750	171	210	19
25003-3381	23	6.125	7.375	0.500	156	187	13	25003-3469	23	10.040	11.811	0.625	255	300	16
25003-3382	23	10.125	11.750	0.750	257	298	19	25003-3471	23	6.688	7.750	0.500	170	197	13
25003-3383	23	6.125	7.375	0.625	156	187	16	25003-3476	23	6.875	8.000	0.625	175	203	16
25003-3385	23-L	15.000	16.000	0.375	381	406	10	25003-3477	23	6.875	7.875	0.438	175	200	11
25003-3387	23	6.125	7.500	0.750	156	191	19	25003-3478	23	6.875	8.125	0.625	175	206	16
25003-3388	23	6.250	7.250	0.500	159	184	13	25003-3480	23	6.875	8.250	0.625	175	210	16
25003-3389	23	4.961	6.024	0.500	126	153	13	25003-3481	23	6.875	8.250	0.750	175	210	19
25003-3394	23	6.250	7.500	0.500	159	191	13	25003-3482	23	6.875	8.375	0.625	175	213	16
25003-3395	23	6.250	7.500	0.562	159	191	14	25003-3483	23	6.875	8.375	0.750	175	213	19
25003-3396	23	6.250	7.500	0.625	159	191	16	25003-3490	23	6.938	8.125	0.750	176	206	19
25003-3398	23	6.250	7.625	0.500	159	194	13	25003-3492	23	7.000	8.000	0.625	178	203	16
25003-3400	23-L	21.654	23.654	0.812	550	601	21	25003-3495	23	7.000	8.125	0.750	178	206	19
25003-3401	23	10.827	11.811	0.492	275	300	12	25003-3496	23	7.000	8.250	0.625	178	210	16
25003-3402	23	6.250	7.750	0.500	159	197	13	25003-3497	23	7.000	8.250	0.750	178	210	19
25003-3404	23	6.250	7.750	0.625	159	197	16	25003-3498	23	7.000	8.375	0.625	178	213	16

All dimensions are in inches. Preferred sizes are indicated with **bold** type face. Sizes listed are for standard nitrile elements, except Models 25 and 62 which have PTFE elements. Other material available on inquiry only.

## Oil Seals by Model Number

Product Code	Model	Inches			MM			Product Code	Model	Inches			MM		
		ID	OD	Width	ID	OD	Width			ID	OD	Width	ID	OD	Width
25003-3499	23	7.000	8.375	0.750	178	213	19	25003-3592	23	8.000	9.000	0.625	203	229	16
25003-3500	23	7.000	8.500	0.625	178	216	16	25003-3594	23	8.000	9.125	0.625	203	232	16
25003-3501	23	7.000	8.500	0.750	178	216	19	25003-3595	23	8.000	9.125	0.750	203	232	19
25003-3502	23	7.000	8.000	0.438	178	203	11	25003-3596	23	8.000	9.250	0.625	203	235	16
25003-3506	23	7.125	8.125	0.625	181	206	16	25003-3597	23	8.000	9.250	0.750	203	235	19
25003-3507	23	11.024	12.756	0.787	280	324	20	25003-3598	23	8.000	9.375	0.625	203	238	16
25003-3508	23	7.125	8.250	0.625	181	210	16	25003-3599	23	8.875	10.875	0.625	225	276	16
25003-3510	23	7.125	8.375	0.625	181	213	16	25003-3600	23	8.000	9.500	0.625	203	241	16
25003-3512	23	7.125	8.500	0.625	181	216	16	25003-3601	23	8.000	9.500	0.750	203	241	19
25003-3515	23	7.125	8.625	0.750	181	219	19	25003-3604	23	8.250	9.250	0.625	210	235	16
25003-3518	23	7.250	8.250	0.625	184	210	16	25003-3606	23	8.250	9.500	0.625	210	241	16
25003-3521	23	7.188	8.437	0.625	183	214	16	25003-3608	23	8.375	9.750	0.750	213	248	19
25003-3522	23	7.250	8.500	0.625	184	216	16	25003-3611	23	8.625	10.625	0.750	219	270	19
25003-3523	23	7.250	8.500	0.750	184	216	19	25003-3616	23	9.000	10.125	0.750	229	257	19
25003-3524	23	7.250	8.625	0.625	184	219	16	25003-3619	23	9.000	10.500	0.750	229	267	19
25003-3525	23	7.250	8.625	0.750	184	219	19	25003-3620	23	9.000	10.625	0.750	229	270	19
25003-3526	23	7.250	8.750	0.625	184	222	16	25003-3621	23	9.000	10.750	0.750	229	273	19
25003-3527	23	7.250	8.750	0.750	184	222	19	25003-3622	23	9.000	10.875	0.750	229	276	19
25003-3528	23	7.375	8.375	0.625	187	213	16	25003-3623	23	9.000	11.000	0.750	229	279	19
25003-3530	23	7.375	8.500	0.625	187	216	16	25003-3632	23	9.250	10.750	0.750	235	273	19
25003-3532	23	7.375	8.625	0.625	187	219	16	25003-3636	23	9.438	10.625	0.750	240	270	19
25003-3533	23	7.375	8.625	0.750	187	219	19	25003-3638	23	9.500	10.500	0.625	241	267	16
25003-3536	23	7.375	8.875	0.625	187	225	16	25003-3640	23	9.500	10.750	0.625	241	273	16
25003-3537	23	7.375	8.875	0.750	187	225	19	25003-3641	23	7.283	8.858	0.625	185	225	16
25003-3538	23	7.375	9.000	0.625	187	229	16	25003-3642	23	9.500	11.000	0.625	241	279	16
25003-3544	23	7.500	8.500	0.625	191	216	16	25003-3645	23	9.500	11.375	0.625	241	289	16
25003-3546	23	7.500	8.625	0.625	191	219	16	25003-3646	23	9.500	11.500	0.625	241	292	16
25003-3548	23	7.500	8.750	0.625	191	222	16	25003-3647	23	9.250	10.826	0.625	235	275	16
25003-3549	23-L	13.875	15.875	0.500	352	403	13	25003-3652	23	9.750	11.000	0.750	248	279	19
25003-3551	23-L	16.068	17.568	0.750	408	446	19	25003-3654	23	9.750	11.250	0.750	248	286	19
25003-3552	23	7.500	9.000	0.625	191	229	16	25003-3660	23	10.000	11.000	0.563	254	279	14
25003-3553	23	7.500	9.000	0.750	191	229	19	25003-3661	23	10.000	11.125	0.563	254	283	14
25003-3554	23	7.500	9.125	0.625	191	232	16	25003-3662	23	10.000	11.250	0.563	254	286	14
25003-3558	23	7.625	8.625	0.625	194	219	16	25003-3666	23	10.000	11.750	0.563	254	298	14
25003-3562	23	7.625	8.875	0.625	194	225	16	25003-3667	23	10.000	11.875	0.563	254	302	14
25003-3563	23-L	13.875	14.875	0.500	352	378	13	25003-3672	23	10.000	11.500	0.750	254	292	19
25003-3564	23	7.625	9.000	0.625	194	229	16	25003-3676	23	10.250	12.250	0.750	260	311	19
25003-3566	23	7.625	9.125	0.625	194	232	16	25003-3679	23	11.500	13.500	0.500	292	343	13
25003-3567	23	7.625	9.125	0.750	194	232	19	25003-3682	23	10.750	11.750	0.563	273	298	14
25003-3569	23	5.000	5.938	0.500	127	151	13	25003-3685	23	10.750	12.250	0.563	273	311	14
25003-3570	23	7.750	8.750	0.625	197	222	16	25003-3686	23	10.750	12.500	0.563	273	318	14
25003-3571	23	10.826	12.000	0.590	275	305	15	25003-3690	23-L	15.472	17.472	0.750	393	444	19
25003-3573	23	7.750	8.875	0.750	197	225	19	25003-3691	23	11.000	12.000	0.625	279	305	16
25003-3574	23	7.750	9.000	0.625	197	229	16	25003-3692	23	11.000	12.250	0.625	279	311	16
25003-3576	23	7.750	9.125	0.625	197	232	16	25003-3693	23	11.000	12.500	0.625	279	318	16
25003-3577	23	7.844	8.844	0.500	199	225	13	25003-3695	23	11.062	12.250	0.750	281	311	19
25003-3578	23	7.750	9.250	0.625	197	235	16	25003-3696	23	11.063	12.500	0.750	281	318	19
25003-3579	23	7.750	9.250	0.750	197	235	19	25003-3701	23	12.000	13.750	0.688	305	349	17
25003-3580	23	7.875	8.875	0.625	200	225	16	25003-3708	23-L	14.173	15.945	0.812	360	405	21
25003-3581	23	7.813	8.813	0.438	198	224	11	25003-3711	23-L	12.992	14.961	0.812	330	380	21
25003-3584	23	7.875	9.125	0.625	200	232	16	25003-3712	23	12.250	13.500	0.625	311	343	16
25003-3586	23	7.875	9.250	0.625	200	235	16	25003-3724	23	11.024	12.795	0.812	280	325	21
25003-3587	23	7.875	9.250	0.750	200	235	19	25003-3728	23-L	14.500	16.500	0.750	368	419	19
25003-3588	23	7.875	9.375	0.625	200	238	16	25003-3741	23-L	18.000	19.500	0.750	457	495	19
25003-3589	23	7.875	9.375	0.750	200	238	19	25003-3747	23-L	18.898	20.866	0.591	480	530	15
25003-3590	23	7.938	9.125	0.625	202	232	16	25003-3755	23-L	23.071	23.976	0.453	586	609	12

All dimensions are in inches. Preferred sizes are indicated with **bold** type face.

Sizes listed are for standard nitrile elements, except Models 25 and 62 which have PTFE elements. Other material available on inquiry only.

## Oil Seals by Model Number

Product Code	Model	Inches			MM			Product Code	Model	Inches			MM		
		ID	OD	Width	ID	OD	Width			ID	OD	Width	ID	OD	Width
25003-3758	23	3.625	4.839	0.500	92	123	13	25003-3928	23	8.125	9.625	0.750	206	244	19
25003-3759	23	10.375	12.197	0.812	264	310	21	25003-3929	23	4.063	5.500	0.562	103	140	14
25003-3760	23-L	21.125	22.125	0.500	537	562	13	25003-3930	23	7.971	9.000	0.375	202	229	10
25003-3766	23-L	16.125	17.625	0.750	410	448	19	25003-3931	23-L	20.385	21.500	0.562	518	546	14
25003-3779	23-L	19.500	21.000	0.750	495	533	19	25003-3933	23	8.375	9.875	0.688	213	251	17
25003-3780	23-L	12.500	14.250	0.750	318	362	19	25003-3934	23	8.375	9.875	0.750	213	251	19
25003-3794	23-L	43.938	45.438	0.750	1116	1154	19	25003-3935	23	8.500	9.500	0.625	216	241	16
25003-3795	23	3.150	4.134	0.500	80	105	13	25003-3937	23	8.500	10.000	0.750	216	254	19
25003-3796	23-L	30.000	32.000	1.000	762	813	25	25003-3938	23	8.500	10.500	0.813	216	267	21
25003-3800	23	4.750	5.675	0.500	121	144	13	25003-3940	23	8.625	10.125	0.750	219	257	19
25003-3801	23	4.000	4.990	0.400	102	127	10	25003-3941	23	8.625	10.250	0.750	219	260	19
25003-3806	23-L	17.713	19.625	0.812	450	498	21	25003-3942	23	8.661	9.842	0.630	220	250	16
25003-3807	23-L	18.625	20.125	0.750	473	511	19	25003-3947	23	8.750	10.250	0.750	222	260	19
25003-3808	23	5.709	6.693	0.394	145	170	10	25003-3948	23	8.750	10.375	0.750	222	264	19
25003-3810	23-L	40.200	41.700	0.750	1021	1059	19	25003-3949	23	8.750	10.500	0.750	222	267	19
25003-3811	23-L	54.200	55.500	0.750	1377	1410	19	25003-3951	23	8.750	10.750	0.750	222	273	19
25003-3812	23	8.268	9.568	0.500	210	243	13	25003-3952	23	8.750	10.750	0.813	222	273	21
25003-3813	23-L	32.500	34.500	1.000	826	876	25	25003-3953	23	8.875	10.875	0.813	225	276	21
25003-3814	23	10.236	11.736	0.625	260	298	16	25003-3955	23	9.000	11.000	0.813	229	279	21
25003-3818	23	8.250	9.500	0.750	210	241	19	25003-3958	23	9.125	10.625	0.750	232	270	19
25003-3819	23	4.125	5.000	0.438	105	127	11	25003-3959	23	9.125	10.750	0.750	232	273	19
25003-3820	23	5.460	6.585	0.375	139	167	10	25003-3965	23	9.250	11.000	0.750	235	279	19
25003-3822	23-L	45.030	46.530	0.750	1144	1182	19	25003-3966	23	7.984	9.000	0.375	203	229	10
25003-3824	23	12.000	13.125	0.625	305	333	16	25003-3967	23	9.250	11.250	0.750	235	286	19
25003-3825	23	3.800	5.062	0.375	97	129	10	25003-3968	23-L	16.500	18.000	0.625	419	457	16
25003-3827	23	3.561	4.560	0.500	90	116	13	25003-3969	23	4.813	5.937	0.500	122	151	13
25003-3828	23	3.460	4.500	0.500	88	114	13	25003-3970	23	6.496	7.677	0.591	165	195	15
25003-3830	23-L	34.500	36.500	1.000	876	927	25	25003-3971	23	9.375	10.875	0.750	238	276	19
25003-3832	23	8.875	10.125	0.625	225	257	16	25003-3972	23	9.375	11.000	0.750	238	279	19
25003-3834	23-L	39.370	41.339	0.866	1000	1050	22	25003-3973	23	9.449	11.024	0.748	240	280	19
25003-3842	23-L	14.000	15.750	0.812	356	400	21	25003-3974	23	7.677	9.252	0.625	195	235	16
25003-3843	23-L	36.000	38.000	1.000	914	965	25	25003-3977	23	9.438	10.500	0.625	240	267	16
25003-3846	23-L	17.710	19.685	0.812	450	500	21	25003-3979	23	9.500	11.000	0.750	241	279	19
25003-3848	23	7.563	8.500	0.625	192	216	16	25003-3981	23	9.500	11.250	0.750	241	286	19
25003-3850	23	4.646	5.906	0.472	118	150	12	25003-3982	23-L	12.375	14.125	0.812	314	359	21
25003-3851	23	3.062	3.938	0.394	78	100	10	25003-3983	23	9.500	11.500	0.750	241	292	19
25003-3852	23	4.815	5.815	0.500	122	148	13	25003-3984	23	9.500	11.500	0.813	241	292	21
25003-3853	23-L	12.000	14.000	0.625	305	356	16	25003-3985	23	9.750	11.250	0.688	248	286	17
25003-3854	23	10.103	11.103	0.500	257	282	13	25003-3988	23	9.687	11.125	0.750	246	283	19
25003-3868	23-L	16.500	17.750	0.750	419	451	19	25003-3989	23	9.750	11.750	0.750	248	298	19
25003-3882	23	6.299	7.677	0.629	160	195	16	25003-3990	23	9.875	11.375	0.750	251	289	19
25003-3885	23	1.750	3.189	0.500	44	81	13	25003-3991	23	9.875	11.500	0.750	251	292	19
25003-3894	23	3.875	4.875	0.375	98	124	10	25003-3992	23	10.000	11.500	0.688	254	292	17
25003-3895	23	8.375	10.000	0.625	213	254	16	25003-3993	23	10.000	11.625	0.750	254	295	19
25003-3899	23-L	14.173	16.142	0.709	360	410	18	25003-3994	23	10.000	11.750	0.750	254	298	19
25003-3901	23	10.236	11.417	0.630	260	290	16	25003-3995	23	10.000	12.000	0.625	254	305	16
25003-3906	23	4.063	5.500	0.500	103	140	13	25003-3996	23	10.000	12.000	0.750	254	305	19
25003-3911	23	7.480	8.859	0.629	190	225	16	25003-3997	23	10.000	12.000	0.813	254	305	21
25003-3913	23	6.299	7.480	0.629	160	190	16	25003-4000	23	10.125	11.625	0.750	257	295	19
25003-3914	23	7.875	9.055	0.551	200	230	14	25003-4002	23	11.000	13.000	0.625	279	330	16
25003-3915	23-L	20.385	21.500	0.750	518	546	19	25003-4003	23	10.125	12.000	0.750	257	305	19
25003-3916	23	4.063	5.375	0.375	103	137	10	25003-4005	23	10.250	11.750	0.750	260	298	19
25003-3917	23	6.438	7.500	0.500	164	191	13	25003-4006	23-L	13.375	15.000	0.750	340	381	19
25003-3920	23	7.087	8.268	0.630	180	210	16	25003-4007	23	10.250	12.000	0.750	260	305	19
25003-3921	23	8.000	9.500	0.687	203	241	17	25003-4008	23-L	18.031	19.882	0.812	458	505	21
25003-3925	23	8.000	10.000	0.750	203	254	19	25003-4009	23	10.250	12.250	0.813	260	311	21

All dimensions are in inches. Preferred sizes are indicated with **bold** type face. Sizes listed are for standard nitrile elements, except Models 25 and 62 which have PTFE elements. Other material available on inquiry only.

## Oil Seals by Model Number

Product Code	Model	Inches			MM			Product Code	Model	Inches			MM		
		ID	OD	Width	ID	OD	Width			ID	OD	Width	ID	OD	Width
25003-4011	23	10.500	12.000	0.688	267	305	17	25003-4099	23-L	13.000	15.000	0.813	330	381	21
25003-4012	23	10.500	12.000	0.750	267	305	19	25003-4100	23-L	35.375	36.625	0.625	899	930	16
25003-4013	23	10.500	12.125	0.750	267	308	19	25003-4102	23-L	13.250	14.750	0.750	337	375	19
25003-4014	23	10.500	12.250	0.750	267	311	19	25003-4103	23-L	13.250	14.875	0.750	337	378	19
25003-4016	23	10.500	12.500	0.750	267	318	19	25003-4104	23-L	13.094	15.094	0.750	333	383	19
25003-4017	23	10.500	12.500	0.813	267	318	21	25003-4115	23	2.313	3.250	0.438	59	83	11
25003-4018	23	10.625	12.125	0.750	270	308	19	25003-4121	23-L	13.500	15.000	0.688	343	381	17
25003-4019	23	10.625	12.250	0.750	270	311	19	25003-4122	23-L	13.500	15.000	0.750	343	381	19
25003-4020	23	10.625	12.375	0.750	270	314	19	25003-4126	23	2.188	3.250	0.438	56	83	11
25003-4024	23	10.750	12.250	0.750	273	311	19	25003-4127	23-L	13.500	15.500	0.750	343	394	19
25003-4030	23	10.750	12.750	0.750	273	324	19	25003-4128	23-L	13.500	15.500	0.813	343	394	21
25003-4031	23	10.750	12.750	0.813	273	324	21	25003-4129	23-L	13.750	15.750	0.813	349	400	21
25003-4032	23	10.875	12.375	0.750	276	314	19	25003-4131	23-L	14.000	15.500	0.688	356	394	17
25003-4033	23-L	15.500	16.750	0.562	394	425	14	25003-4132	23-L	14.000	15.500	0.750	356	394	19
25003-4036	23	11.000	13.000	0.813	279	330	21	25003-4133	23-L	14.000	15.563	0.750	356	395	19
25003-4040	23	2.938	3.906	0.375	75	99	10	25003-4134	23-L	14.000	15.750	0.750	356	400	19
25003-4041	23	10.236	11.811	0.551	260	300	14	25003-4135	23-L	14.000	16.000	0.813	356	406	21
25003-4042	23	8.661	10.236	0.551	220	260	14	25003-4136	23	10.039	11.181	0.630	255	284	16
25003-4043	23	5.906	7.480	0.551	150	190	14	25003-4137	23-L	13.875	15.875	0.813	352	403	21
25003-4044	23	6.299	7.874	0.551	160	200	14	25003-4138	23-L	14.190	15.690	0.625	360	399	16
25003-4045	23	6.693	7.874	0.551	170	200	14	25003-4140	23-L	14.250	16.250	0.813	362	413	21
25003-4046	23	11.250	12.750	0.750	286	324	19	25003-4142	23-L	14.500	16.000	0.688	368	406	17
25003-4047	23	11.250	13.250	0.813	286	337	21	25003-4143	23-L	14.500	16.000	0.750	368	406	19
25003-4049	23	11.125	13.125	0.813	283	333	21	25003-4145	23-L	14.500	16.500	0.813	368	419	21
25003-4050	23	11.375	12.875	0.750	289	327	19	25003-4147	23-L	14.750	16.250	0.688	375	413	17
25003-4051	23	11.375	13.000	0.750	289	330	19	25003-4148	23-L	14.750	16.250	0.750	375	413	19
25003-4054	23	7.087	8.661	0.551	180	220	14	25003-4149	23-L	14.750	16.500	0.750	375	419	19
25003-4057	23	11.500	13.000	0.688	292	330	17	25003-4151	23-L	15.000	16.500	0.688	381	419	17
25003-4058	23	11.500	13.000	0.750	292	330	19	25003-4152	23-L	15.000	16.500	0.750	381	419	19
25003-4059	23-L	17.094	19.094	0.787	434	485	20	25003-4153	23-L	15.000	16.750	0.750	381	425	19
25003-4060	23	11.500	13.250	0.750	292	337	19	25003-4155	23-L	15.000	17.000	0.750	381	432	19
25003-4061	23	11.500	13.375	0.750	292	340	19	25003-4156	23-L	15.000	17.000	0.813	381	432	21
25003-4062	23	11.500	13.500	0.750	292	343	19	25003-4158	23-L	15.313	16.875	0.688	389	429	17
25003-4063	23	11.500	13.500	0.813	292	343	21	25003-4159	23-L	15.375	17.375	0.813	391	441	21
25003-4064	23	11.750	13.250	0.688	298	337	17	25003-4161	23	10.750	12.000	0.594	273	305	15
25003-4065	23	11.750	13.250	0.750	298	337	19	25003-4162	23-L	15.500	17.000	0.750	394	432	19
25003-4066	23	5.313	6.500	0.406	135	165	10	25003-4163	23-L	15.500	17.500	0.813	394	445	21
25003-4067	23	12.000	13.500	0.750	305	343	19	25003-4176	23-L	15.875	17.875	0.813	403	454	21
25003-4068	23	12.000	13.625	0.750	305	346	19	25003-4178	23-L	16.000	17.500	0.750	406	445	19
25003-4069	23	12.250	13.375	0.625	311	340	16	25003-4180	23-L	16.000	18.000	0.813	406	457	21
25003-4071	23-L	12.000	14.000	0.750	305	356	19	25003-4181	23-L	16.250	17.750	0.688	413	451	17
25003-4072	23-L	12.000	14.000	0.813	305	356	21	25003-4182	23-L	16.250	17.750	0.750	413	451	19
25003-4074	23	12.250	13.750	0.750	311	349	19	25003-4184	23-L	16.250	18.000	0.750	413	457	19
25003-4075	23-L	12.250	14.250	0.813	311	362	21	25003-4185	23-L	16.500	18.000	0.750	419	457	19
25003-4077	23	12.375	13.875	0.750	314	352	19	25003-4186	23-L	16.500	18.500	0.813	419	470	21
25003-4079	23-L	12.500	14.000	0.688	318	356	17	25003-4187	23-L	27.559	29.528	0.787	700	750	20
25003-4080	23-L	12.500	14.000	0.750	318	356	19	25003-4188	23-L	17.000	18.500	0.687	432	470	17
25003-4082	23-L	12.500	14.500	0.750	318	368	19	25003-4189	23-L	17.000	18.500	0.750	432	470	19
25003-4083	23-L	12.500	14.500	0.813	318	368	21	25003-4190	23-L	17.000	19.000	0.813	432	483	21
25003-4086	23-L	12.625	14.125	0.750	321	359	19	25003-4195	23-L	17.500	19.000	0.750	445	483	19
25003-4088	23-L	12.750	14.250	0.625	324	362	16	25003-4196	23-L	17.500	19.250	0.750	445	489	19
25003-4089	23-L	12.750	14.250	0.688	324	362	17	25003-4198	23-L	17.500	19.500	0.688	445	495	17
25003-4093	23-L	13.000	14.500	0.688	330	368	17	25003-4200	23-L	17.750	19.750	0.813	451	502	21
25003-4094	23-L	13.000	14.500	0.750	330	368	19	25003-4204	23-L	17.875	19.875	0.813	454	505	21
25003-4095	23-L	13.000	14.625	0.750	330	371	19	25003-4206	23-L	18.000	19.500	0.688	457	495	17
25003-4098	23-L	13.000	15.000	0.750	330	381	19	25003-4209	23-L	18.000	20.000	0.750	457	508	19

All dimensions are in inches. Preferred sizes are indicated with **bold** type face. Sizes listed are for standard nitrile elements, except Models 25 and 62 which have PTFE elements. Other material available on inquiry only.

## Oil Seals by Model Number

Product Code	Model	Inches			MM			Product Code	Model	Inches			MM		
		ID	OD	Width	ID	OD	Width			ID	OD	Width	ID	OD	Width
25003-4211	23-L	18.250	19.750	0.750	464	502	19	25003-4479	23	6.938	8.500	0.625	176	216	16
25003-4212	23-L	18.250	19.875	0.750	464	505	19	25003-4480	23-L	12.625	14.000	0.750	321	356	19
25003-4213	23-L	18.375	19.875	0.688	467	505	17	25003-4481	23-L	27.559	29.055	0.748	700	738	19
25003-4217	23-L	18.750	20.250	0.750	476	514	19	25003-4484	23	10.750	12.375	0.625	273	314	16
25003-4218	23-L	19.000	20.500	0.750	483	521	19	25003-4489	23	5.512	6.387	0.375	140	162	10
25003-4220	23	3.750	4.765	0.500	95	121	13	25003-4490	23	6.063	7.500	0.500	154	191	13
25003-4223	23	4.000	5.015	0.500	102	127	13	25003-4495	23	10.500	12.000	0.625	267	305	16
25003-4226	23	4.142	5.543	0.500	105	141	13	25003-4496	23-L	12.500	14.000	0.625	318	356	16
25003-4230	23-L	20.000	21.750	0.813	508	552	21	25003-4497	23	9.842	11.417	0.590	250	290	15
25003-4234	23-L	12.598	14.173	0.375	320	360	10	25003-4502	23	8.500	10.000	0.625	216	254	16
25003-4235	23-L	20.000	21.500	0.750	508	546	19	25003-4503	23	9.000	10.000	0.625	229	254	16
25003-4239	23-L	20.250	21.750	0.750	514	552	19	25003-4504	23	9.000	10.125	0.625	229	257	16
25003-4252	23-L	14.000	15.625	0.750	356	397	19	25003-4505	23	9.000	10.250	0.625	229	260	16
25003-4267	23-L	14.000	15.422	0.520	356	392	13	25003-4507	23	9.000	10.500	0.625	229	267	16
25003-4269	23-L	22.000	23.500	0.750	559	597	19	25003-4508	23	9.000	10.625	0.625	229	270	16
25003-4304	23-L	24.438	26.438	0.750	621	672	19	25003-4509	23	9.250	10.250	0.625	235	260	16
25003-4308	23-L	25.000	26.500	0.750	635	673	19	25003-4511	23	9.250	10.500	0.625	235	267	16
25003-4315	23-L	27.500	29.000	0.750	699	737	19	25003-4512	23	9.625	10.875	0.750	244	276	19
25003-4317	23-L	25.500	27.000	0.750	648	686	19	25003-4513	23	9.750	10.750	0.625	248	273	16
25003-4343	23-L	28.000	29.500	0.750	711	749	19	25003-4515	23	9.750	11.000	0.625	248	279	16
25003-4346	23-L	28.500	30.500	0.875	724	775	22	25003-4516	23	9.750	11.125	0.625	248	283	16
25003-4347	23-L	29.000	30.500	0.750	737	775	19	25003-4517	23	9.750	11.250	0.625	248	286	16
25003-4351	23-L	17.360	19.360	0.813	441	492	21	25003-4520	23	10.750	12.000	0.625	273	305	16
25003-4356	23-L	30.000	31.500	0.750	762	800	19	25003-4521	23-L	16.535	18.504	0.748	420	470	19
25003-4363	23-L	25.375	27.375	0.812	645	695	21	25003-4522	23	10.750	12.250	0.625	273	311	16
25003-4366	23	4.500	5.812	0.580	114	148	15	25003-4523	23-L	17.750	19.000	0.750	451	483	19
25003-4367	23-L	31.000	33.000	0.875	787	838	22	25003-4525	23-L	19.750	20.750	0.500	502	527	13
25003-4369	23	6.188	7.500	0.500	157	191	13	25003-4527	23	11.250	12.750	0.688	286	324	17
25003-4374	23-L	17.313	18.313	0.500	440	465	13	25003-4530	23-L	13.750	15.250	0.750	349	387	19
25003-4381	23-L	33.000	34.500	0.750	838	876	19	25003-4532	23-L	13.750	15.750	0.750	349	400	19
25003-4384	23-L	14.125	15.125	0.500	359	384	13	25003-4533	23-L	26.500	28.000	0.750	673	711	19
25003-4385	23	4.252	5.118	0.512	108	130	13	25003-4536	23	4.813	6.313	0.500	122	160	13
25003-4386	23-L	40.157	41.339	0.748	1020	1050	19	25003-4551	23	6.250	7.185	0.500	159	182	13
25003-4387	23	2.362	3.228	0.472	60	82	12	25003-4556	23-L	42.750	44.250	0.750	1086	1124	19
25003-4388	23	6.625	7.938	0.625	168	202	16	25003-4557	23	3.000	4.000	0.500	76	102	13
25003-4393	23-L	17.323	18.898	0.787	440	480	20	25003-4560	23	6.500	7.500	0.500	165	191	13
25003-4394	23-L	28.250	30.250	1.250	718	768	32	25003-4561	23	7.125	8.125	0.500	181	206	13
25003-4397	23	4.125	5.281	0.500	105	134	13	25003-4566	23	10.375	11.500	0.750	264	292	19
25003-4403	23-L	17.500	19.000	0.625	445	483	16	25003-4568	23-L	13.969	15.469	0.750	355	393	19
25003-4412	23	6.299	7.874	0.531	160	200	14	25003-4576	23	5.375	6.313	0.500	137	160	13
25003-4414	23-L	14.875	16.500	0.750	378	419	19	25003-4595	23	6.438	7.500	0.625	164	191	16
25003-4415	23	5.709	7.087	0.591	145	180	15	25003-4596	23-L	13.383	14.883	0.750	340	378	19
25003-4422	23-L	25.000	25.904	0.500	635	658	13	25003-4601	23-L	14.961	16.693	0.787	380	424	20
25003-4426	23	3.875	5.062	0.375	98	129	10	25003-4602	23	11.811	13.543	0.787	300	344	20
25003-4435	23-L	37.000	39.000	1.000	940	991	25	25003-4604	23	11.938	13.438	0.625	303	341	16
25003-4438	23-L	37.500	39.500	0.875	953	1003	22	25003-4608	23-L	48.000	50.000	1.000	1219	1270	25
25003-4439	23	11.188	12.500	0.750	284	318	19	25003-4610	23	9.375	11.375	0.813	238	289	21
25003-4440	23-L	57.500	59.500	0.812	1461	1511	21	25003-4612	23	12.000	13.500	0.688	305	343	17
25003-4450	23	11.000	12.375	0.750	279	314	19	25003-4615	23-L	15.250	16.750	0.688	387	425	17
25003-4452	23	11.938	13.760	0.750	303	350	19	25003-4616	23	3.938	4.875	0.437	100	124	11
25003-4455	23	3.750	4.750	0.438	95	121	11	25003-4617	23-L	19.250	20.750	0.750	489	527	19
25003-4457	23	7.087	8.465	0.630	180	215	16	25003-4618	23	9.937	11.937	0.625	252	303	16
25003-4461	23	5.500	6.756	0.500	140	172	13	25003-4619	23-L	20.500	22.000	0.750	521	559	19
25003-4476	23-L	15.250	17.250	0.813	387	438	21	25003-4621	23-L	21.750	23.250	0.750	552	591	19
25003-4477	23	6.938	8.125	0.625	176	206	16	25003-4623	23-L	24.000	25.500	0.750	610	648	19
25003-4478	23	6.938	8.375	0.625	176	213	16	25003-4624	23	6.889	7.874	0.591	175	200	15

All dimensions are in inches. Preferred sizes are indicated with **bold** type face.  
 Sizes listed are for standard nitrile elements, except Models 25 and 62 which have PTFE elements. Other material available on inquiry only.

## Oil Seals by Model Number

Product Code	Model	Inches			MM			Product Code	Model	Inches			MM		
		ID	OD	Width	ID	OD	Width			ID	OD	Width	ID	OD	Width
25003-4625	23-L	15.500	16.500	0.500	394	419	13	25003-4775	23	6.220	7.750	0.625	158	197	16
25003-4629	23-L	15.748	17.480	0.787	400	444	20	25003-4776	23	3.938	5.188	0.500	100	132	13
25003-4630	23-L	12.992	14.724	0.787	330	374	20	25003-4778	23	10.313	11.938	0.813	262	303	21
25003-4634	23	6.299	7.480	0.500	160	190	13	25003-4779	23-L	13.250	15.250	0.813	337	387	21
25003-4640	23	3.500	4.500	0.469	89	114	12	25003-4785	23	11.962	12.688	0.500	304	322	13
25003-4651	23	4.000	5.000	0.500	102	127	13	25003-4786	23	5.313	6.578	0.500	135	167	13
25003-4655	23	11.811	13.386	0.787	300	340	20	25003-4788	23-L	12.750	14.000	0.750	324	356	19
25003-4656	23	5.118	6.299	0.472	130	160	12	25003-4789	23	6.000	7.085	0.438	152	180	11
25003-4658	23-L	70.688	72.688	0.875	1795	1846	22	25003-4792	23	5.315	6.825	0.500	135	173	13
25003-4660	23	5.188	6.188	0.500	132	157	13	25003-4796	23	4.563	5.688	0.500	116	144	13
25003-4663	23-L	17.250	18.750	0.625	438	476	16	25003-4797	23	3.375	4.437	0.375	86	113	10
25003-4664	23-L	15.875	17.375	0.750	403	441	19	25003-4799	23	8.375	9.875	0.625	213	251	16
25003-4666	23-L	13.504	15.504	0.813	343	394	21	25003-4803	23	9.125	10.375	0.625	232	264	16
25003-4667	23-L	17.795	19.795	0.813	452	503	21	25003-4804	23	3.000	4.250	0.500	76	108	13
25003-4673	23-L	19.000	20.125	0.547	483	511	14	25003-4805	23	10.236	11.968	0.787	260	304	20
25003-4675	23-L	24.500	25.625	0.500	622	651	13	25003-4806	23	3.346	4.331	0.512	85	110	13
25003-4676	23-L	25.750	26.875	0.500	654	683	13	25003-4807	23	3.715	4.750	0.515	94	121	13
25003-4678	23-L	19.625	21.625	0.813	498	549	21	25003-4809	23-L	64.748	66.717	0.787	1645	1695	20
25003-4688	23	3.375	4.375	0.438	86	111	11	25003-4810	23	8.063	9.313	0.500	205	237	13
25003-4691	23-L	14.250	16.000	0.813	362	406	21	25003-4811	23-L	68.988	70.957	0.787	1752	1802	20
25003-4694	23	6.375	7.750	0.625	162	197	16	25003-4812	23	10.438	12.000	0.750	265	305	19
25003-4698	23-L	25.875	26.875	0.500	657	683	13	25003-4814	23	3.875	4.885	0.500	98	124	13
25003-4699	23-L	14.500	15.750	0.625	368	400	16	25003-4815	23-L	17.875	18.875	0.500	454	479	13
25003-4702	23-L	75.000	76.000	0.375	1905	1930	10	25003-4817	23	3.938	4.938	0.500	100	125	13
25003-4705	23	4.438	5.438	0.375	113	138	10	25003-4820	23	4.438	5.563	0.500	113	141	13
25003-4707	23	12.000	13.500	0.625	305	343	16	25003-4822	23	8.000	9.000	0.438	203	229	11
25003-4710	23	3.437	5.000	0.500	87	127	13	25003-4823	23	9.563	10.563	0.500	243	268	13
25003-4714	23-L	26.000	27.000	0.500	660	686	13	25003-4826	23	7.086	8.086	0.500	180	205	13
25003-4724	23	9.250	10.500	0.500	235	267	13	25003-4831	23	5.511	6.511	0.500	140	165	13
25003-4727	23	8.500	10.250	0.750	216	260	19	25003-4833	23	7.760	8.875	0.500	197	225	13
25003-4728	23-L	24.803	26.772	0.787	630	680	20	25003-4839	23-L	24.875	26.875	0.813	632	683	21
25003-4729	23	6.125	7.625	0.750	156	194	19	25003-4841	23	5.420	6.625	0.500	138	168	13
25003-4730	23	6.950	8.125	0.750	177	206	19	25003-4842	23	4.438	5.375	0.375	113	137	10
25003-4732	23-L	18.504	20.079	0.787	470	510	20	25003-4846	23	3.543	4.527	0.500	90	115	13
25003-4733	23	5.250	6.563	0.750	133	167	19	25003-4847	23	4.133	5.110	0.472	105	130	12
25003-4738	23	4.000	4.897	0.500	102	124	13	25003-4850	23	9.892	11.338	0.750	251	288	19
25003-4742	23	3.719	5.094	0.500	94	129	13	25003-4854	23	10.688	12.688	0.750	271	322	19
25003-4743	23-L	32.500	33.625	0.563	826	854	14	25003-4855	23	2.906	3.906	0.375	74	99	10
25003-4745	23	3.500	5.000	0.375	89	127	10	25003-4856	23-L	62.000	64.000	0.813	1575	1626	21
25003-4747	23	3.933	4.933	0.500	100	125	13	25003-4857	23-L	29.875	31.875	0.813	759	810	21
25003-4750	23	5.438	6.438	0.500	138	164	13	25003-4860	23	7.875	8.816	0.500	200	224	13
25003-4756	23-L	14.688	16.688	0.813	373	424	21	25003-4862	23	5.906	7.283	0.708	150	185	18
25003-4757	23	8.661	9.842	0.512	220	250	13	25003-4863	23-L	22.320	24.320	0.813	567	618	21
25003-4758	23	4.188	5.188	0.375	106	132	10	25003-4864	23	3.625	4.875	0.375	92	124	10
25003-4759	23	4.812	5.750	0.500	122	146	13	25003-4865	23	9.055	11.024	0.630	230	280	16
25003-4760	23	8.250	9.375	0.500	210	238	13	25003-4867	23	11.000	12.750	0.750	279	324	19
25003-4761	23-L	52.000	54.000	0.813	1321	1372	21	25003-4872	23-L	35.433	37.402	0.787	900	950	20
25003-4762	23	5.625	7.000	0.750	143	178	19	25003-4873	23	4.500	5.500	0.438	114	140	11
25003-4763	23	7.938	8.875	0.500	202	225	13	25003-4874	23-L	24.000	25.500	0.700	610	648	18
25003-4764	23	10.063	11.688	0.750	256	297	19	25003-4879	23	3.313	4.125	0.500	84	105	13
25003-4765	23	2.755	3.543	0.375	70	90	10	25003-4880	23	4.166	5.506	0.500	106	140	13
25003-4768	23	3.150	4.249	0.438	80	108	11	25003-4881	23	11.811	13.780	0.748	300	350	19
25003-4769	23	3.070	3.938	0.437	78	100	11	25003-4885	23	9.055	10.630	0.630	230	270	16
25003-4770	23-L	13.000	14.250	0.625	330	362	16	25003-4886	23	7.188	8.563	0.625	183	218	16
25003-4771	23	4.500	5.750	0.375	114	146	10	25003-4889	23	7.500	8.875	0.500	191	225	13
25003-4772	23	3.875	5.000	0.500	98	127	13	25003-4893	23	8.375	9.625	0.625	213	244	16

All dimensions are in inches. Preferred sizes are indicated with **bold** type face.

Sizes listed are for standard nitrile elements, except Models 25 and 62 which have PTFE elements. Other material available on inquiry only.

## Oil Seals by Model Number

Product Code	Model	Inches			MM			Product Code	Model	Inches			MM		
		ID	OD	Width	ID	OD	Width			ID	OD	Width	ID	OD	Width
25003-4895	23	12.250	13.821	0.750	311	351	19	25003-5100	23	3.542	4.542	0.375	90	115	10
25003-4897	23-L	29.918	31.418	0.750	760	798	19	25003-5102	23-L	26.875	28.875	0.813	683	733	21
25003-4900	23	6.813	8.313	0.750	173	211	19	25003-5107	23-L	46.000	48.000	0.813	1168	1219	21
25003-4911	23	12.000	13.750	0.750	305	349	19	25003-5114	23	12.500	13.500	0.500	318	343	13
25003-4912	23-L	82.283	84.252	0.813	2090	2140	21	25003-5116	23-L	16.000	18.000	0.750	406	457	19
25003-4919	23-L	88.031	90.031	0.813	2236	2287	21	25003-5117	23-L	14.250	16.250	0.750	362	413	19
25003-4921	23	7.375	8.375	0.500	187	213	13	25003-5118	23	4.724	5.906	0.500	120	150	13
25003-4922	23	8.500	9.750	0.500	216	248	13	25003-5119	23	6.063	7.563	0.750	154	192	19
25003-4923	23	10.000	11.250	0.500	254	286	13	25003-5122	23	3.500	4.625	0.375	89	117	10
25003-4924	23	7.000	8.250	0.500	178	210	13	25003-5126	23	9.156	10.656	0.750	233	271	19
25003-4926	23-L	20.250	22.250	0.813	514	565	21	25003-5127	23	2.875	4.125	0.500	73	105	13
25003-4934	23	4.750	6.250	0.750	121	159	19	25003-5130	23-L	18.625	20.625	0.812	473	524	21
25003-4935	23	4.563	5.563	0.375	116	141	10	25003-5132	23	3.188	4.313	0.500	81	110	13
25003-4939	23	4.563	5.563	0.375	116	141	10	25003-5134	23-L	14.375	16.375	0.750	365	416	19
25003-4940	23-L	21.000	22.000	0.500	533	559	13	25003-5138	23	4.938	6.188	0.500	125	157	13
25003-4948	23	3.188	4.188	0.500	81	106	13	25003-5139	23	6.625	8.125	0.500	168	206	13
25003-4949	23-L	15.000	17.000	0.500	381	432	13	25003-5141	23-L	25.750	26.750	0.500	654	679	13
25003-4950	23	10.000	11.500	0.625	254	292	16	25003-5153	23	8.875	10.125	0.625	225	257	16
25003-4954	23	3.071	4.571	0.500	78	116	13	25003-5158	23-L	19.000	20.000	0.500	483	508	13
25003-4963	23	10.563	12.563	0.750	268	319	19	25003-5159	23-L	33.000	34.000	0.500	838	864	13
25003-4969	23-L	13.000	14.125	0.547	330	359	14	25003-5160	23	3.250	4.750	0.438	83	121	11
25003-4970	23-L	15.000	16.125	0.547	381	410	14	25003-5161	23	8.313	9.313	0.500	211	237	13
25003-4971	23-L	17.000	18.125	0.547	432	460	14	25003-5166	23	4.875	5.875	0.375	124	149	10
25003-4981	23	8.750	10.000	0.515	222	254	13	25003-5168	23-L	17.000	19.000	0.750	432	483	19
25003-4989	23	9.724	10.724	0.500	247	272	13	25003-5172	23-L	17.625	18.500	0.375	448	470	10
25003-4990	23	7.854	8.854	0.500	199	225	13	25003-5174	23-L	40.500	42.000	0.750	1029	1067	19
25003-4992	23	8.859	9.859	0.500	225	250	13	25003-5178	23-L	16.378	17.874	0.748	416	454	19
25003-4994	23	10.728	11.728	0.500	272	298	13	25003-5186	23	10.236	11.736	0.750	260	298	19
25003-5003	23	4.475	5.500	0.500	114	140	13	25003-5189	23	5.125	6.125	0.375	130	156	10
25003-5006	23	11.000	12.625	0.625	279	321	16	25003-5190	23	4.188	5.688	0.375	106	144	10
25003-5009	23	8.063	9.563	0.750	205	243	19	25003-5202	23-L	37.250	39.250	0.813	946	997	21
25003-5010	23	5.500	7.000	0.750	140	178	19	25003-5204	23-L	39.500	41.500	0.812	1003	1054	21
25003-5012	23	11.500	12.875	0.750	292	327	19	25003-5209	23	3.125	4.000	0.500	79	102	13
25003-5014	23	11.344	12.594	0.625	288	320	16	25003-5213	23	8.875	10.500	0.750	225	267	19
25003-5017	23-L	26.375	28.375	0.813	670	721	21	25003-5219	23-L	40.500	42.500	0.813	1029	1080	21
25003-5023	23	3.000	4.000	0.375	76	102	10	25003-5222	23	5.000	6.062	0.500	127	154	13
25003-5025	23	3.125	4.250	0.500	79	108	13	25003-5236	23-L	77.500	79.500	0.813	1969	2019	21
25003-5029	23-L	16.929	18.897	0.787	430	480	20	25003-5241	23	7.563	9.062	0.750	192	230	19
25003-5032	23	6.688	7.938	0.500	170	202	13	25003-5245	23-L	51.000	52.000	0.500	1295	1321	13
25003-5033	23-L	31.250	33.250	0.750	794	845	19	25003-5254	23-L	22.125	24.125	0.812	562	613	21
25003-5039	23-L	16.250	17.250	0.500	413	438	13	25003-5258	23-L	21.653	23.153	0.750	550	588	19
25003-5050	23-L	27.000	28.500	0.625	686	724	16	25003-5259	23-L	21.000	22.500	0.750	533	572	19
25003-5051	23	3.563	4.563	0.500	91	116	13	25003-5261	23	11.375	13.000	0.688	289	330	17
25003-5055	23-L	20.500	22.500	0.813	521	572	21	25003-5262	23-L	19.500	20.500	0.500	495	521	13
25003-5057	23	6.063	7.125	0.500	154	181	13	25003-5263	23-L	29.250	30.250	0.500	743	768	13
25003-5058	23	4.688	5.938	0.500	119	151	13	25003-5264	23-L	57.086	59.086	0.812	1450	1501	21
25003-5061	23-L	49.498	51.375	0.813	1257	1305	21	25003-5266	23-L	28.500	29.500	0.500	724	749	13
25003-5062	23-L	14.250	15.750	0.750	362	400	19	25003-5267	23-L	41.929	43.929	0.813	1065	1116	21
25003-5067	23	10.625	11.625	0.625	270	295	16	25003-5271	23-L	19.125	20.125	0.500	486	511	13
25003-5075	23	4.310	5.300	0.475	109	135	12	25003-5273	23-L	52.000	53.000	0.500	1321	1346	13
25003-5079	23	3.750	5.000	0.500	95	127	13	25003-5274	23-L	55.000	56.000	0.500	1397	1422	13
25003-5081	23-L	42.750	43.750	0.500	1086	1111	13	25003-5278	23-L	26.781	28.781	0.812	680	731	21
25003-5082	23	9.875	11.875	0.750	251	302	19	25003-5279	23-L	84.000	86.000	0.812	2134	2184	21
25003-5092	23	5.313	6.563	0.625	135	167	16	25003-5281	23-L	29.625	31.625	0.812	752	803	21
25003-5097	23	3.688	5.000	0.500	94	127	13	25003-5287	23-L	43.543	45.543	0.812	1106	1157	21
25003-5099	23-L	18.938	20.938	0.813	481	532	21	25003-5290	23-L	15.354	16.929	0.748	390	430	19

All dimensions are in inches. Preferred sizes are indicated with **bold** type face. Sizes listed are for standard nitrile elements, except Models 25 and 62 which have PTFE elements. Other material available on inquiry only.



## Oil Seals by Model Number

Product Code	Model	Inches			MM			Product Code	Model	Inches			MM		
		ID	OD	Width	ID	OD	Width			ID	OD	Width	ID	OD	Width
25003-5291	23-L	19.875	21.875	0.813	505	556	21	25003-5386	23-L	44.000	46.000	0.813	1118	1168	21
25003-5294	23	10.625	11.625	0.415	270	295	11	25003-5388	23	5.118	6.118	0.500	130	155	13
25003-5297	23-L	85.000	87.000	0.812	2159	2210	21	25003-5395	23	11.125	12.500	0.750	283	318	19
25003-5298	23	11.625	13.625	0.812	295	346	21	25003-5397	23	11.375	12.625	0.625	289	321	16
25003-5302	23-L	21.375	23.375	0.813	543	594	21	25003-5402	23	8.464	9.448	0.500	215	240	13
25003-5303	23	11.027	12.500	0.625	280	318	16	25003-5403	23	9.055	10.039	0.500	230	255	13
25003-5307	23	11.575	12.575	0.500	294	319	13	25003-5409	23-L	45.750	47.750	0.750	1162	1213	19
25003-5308	23	8.394	9.394	0.500	213	239	13	25003-5425	23-L	35.000	36.500	0.750	889	927	19
25003-5312	23-L	21.000	22.750	0.750	533	578	19	25003-5426	23	3.250	4.125	0.500	83	105	13
25003-5313	23	3.625	4.500	0.500	92	114	13	25003-5428	23-L	21.688	23.188	0.750	551	589	19
25003-5320	23	9.250	10.250	0.438	235	260	11	25003-5431	23-L	18.110	20.110	0.813	460	511	21
25003-5326	23-L	39.250	40.750	0.750	997	1035	19	25003-5432	23-L	18.031	20.031	0.813	458	509	21
25003-5331	23	4.250	5.687	0.500	108	144	13	25003-5433	23-L	52.500	54.500	0.813	1334	1384	21
25003-5333	23	7.480	8.661	0.492	190	220	12	25003-5435	23-L	32.125	34.125	0.813	816	867	21
25003-5334	23	9.055	10.236	0.590	230	260	15	25003-5443	23	4.750	5.625	0.500	121	143	13
25003-5335	23	5.906	7.086	0.551	150	180	14	25003-5446	23-L	11.811	13.189	0.709	300	335	18
25003-5336	23	7.086	8.267	0.492	180	210	12	25003-5449	23	4.437	5.250	0.375	113	133	10
25003-5337	23	7.875	9.055	0.492	200	230	12	25003-5455	23-L	14.500	16.250	0.625	368	413	16
25003-5338	23	8.267	9.448	0.590	210	240	15	25003-5459	23	4.922	5.922	0.500	125	150	13
25003-5339	23	9.843	11.024	0.591	250	280	15	25003-5460	23	3.250	4.500	0.438	83	114	11
25003-5340	23	12.204	13.385	0.590	310	340	15	25003-5461	23	8.470	9.500	0.500	215	241	13
25003-5341	23-L	12.992	14.173	0.591	330	360	15	25003-5462	23	11.000	12.813	0.625	279	325	16
25003-5346	23	4.330	5.511	0.551	110	140	14	25003-5463	23	9.500	11.437	0.625	241	290	16
25003-5347	23	4.527	5.708	0.551	115	145	14	25003-5472	23	9.938	11.938	0.750	252	303	19
25003-5348	23	4.724	5.906	0.551	120	150	14	25003-5475	23-L	14.950	16.500	0.750	380	419	19
25003-5349	23	5.708	6.889	0.551	145	175	14	25003-5477	23-L	13.780	15.276	0.500	350	388	13
25003-5350	23	10.629	11.811	0.590	270	300	15	25003-5480	23	8.750	9.875	0.750	222	251	19
25003-5351	23	10.236	11.417	0.590	260	290	15	25003-5481	23-L	14.375	16.000	0.687	365	406	17
25003-5352	23	11.811	12.992	0.591	300	330	15	25003-5490	23	5.115	6.115	0.500	130	155	13
25003-5353	23	4.133	5.314	0.551	105	135	14	25003-5495	23	4.750	5.625	0.625	121	143	16
25003-5354	23	4.921	6.102	0.551	125	155	14	25003-5504	23-L	28.000	29.125	0.500	711	740	13
25003-5355	23	5.314	6.496	0.551	135	165	14	25003-5506	23-L	18.563	19.562	0.500	472	497	13
25003-5356	23	6.693	7.875	0.492	170	200	12	25003-5508	23-L	15.000	16.000	0.500	381	406	13
25003-5357	23	8.661	9.842	0.590	220	250	15	25003-5510	23-L	54.500	56.500	0.813	1384	1435	21
25003-5358	23	8.464	9.645	0.590	215	245	15	25003-5511	23	5.315	6.299	0.500	135	160	13
25003-5359	23	9.448	10.629	0.590	240	270	15	25003-5514	23-L	30.125	31.125	0.500	765	791	13
25003-5361	23-L	32.375	33.625	0.625	822	854	16	25003-5516	23	5.203	6.312	0.500	132	160	13
25003-5363	23	3.938	4.921	0.433	100	125	11	25003-5519	23-L	35.000	36.000	0.500	889	914	13
25003-5364	23	4.330	5.315	0.433	110	135	11	25003-5523	23	10.250	11.750	0.625	260	298	16
25003-5365	23	4.527	5.511	0.433	115	140	11	25003-5525	23	8.780	10.780	0.750	223	274	19
25003-5366	23	4.724	5.708	0.433	120	145	11	25003-5532	23-L	22.673	24.173	0.750	576	614	19
25003-5367	23	5.118	6.259	0.472	130	159	12	25003-5533	23-L	69.375	71.375	0.813	1762	1813	21
25003-5368	23	5.511	6.811	0.547	140	173	14	25003-5534	23-L	17.563	19.062	0.750	446	484	19
25003-5370	23	6.693	7.992	0.547	170	203	14	25003-5536	23	12.205	13.189	0.500	310	335	13
25003-5371	23	7.086	8.385	0.547	180	213	14	25003-5552	23-L	24.000	25.125	0.500	610	638	13
25003-5372	23	7.875	9.448	0.618	200	240	16	25003-5553	23-L	23.750	25.750	0.813	603	654	21
25003-5374	23	9.055	10.866	0.684	230	276	17	25003-5558	23	12.313	13.938	0.750	313	354	19
25003-5375	23	9.842	11.653	0.684	250	296	17	25003-5559	23	8.875	10.625	0.812	225	270	21
25003-5376	23-L	38.750	40.688	0.813	984	1033	21	25003-5563	23	6.188	7.250	0.500	157	184	13
25003-5377	23	4.922	6.063	0.487	125	154	12	25003-5575	23	9.063	10.062	0.375	230	256	10
25003-5378	23	5.315	6.456	0.487	135	164	12	25003-5576	23	12.598	13.583	0.500	320	345	13
25003-5380	23	9.448	11.259	0.684	240	286	17	25003-5577	23-L	51.000	52.875	0.813	1295	1343	21
25003-5381	23	10.236	12.047	0.684	260	306	17	25003-5578	23	7.563	9.065	0.375	192	230	10
25003-5383	23-L	13.625	14.625	0.500	346	371	13	25003-5579	23-L	45.000	46.500	0.750	1143	1181	19
25003-5384	23	8.125	9.125	0.438	206	232	11	25003-5585	23	5.000	6.000	0.687	127	152	17
25003-5385	23-L	55.500	57.500	0.813	1410	1461	21	25003-5586	23-L	64.488	66.488	0.813	1638	1689	21

All dimensions are in inches. Preferred sizes are indicated with **bold** type face.

Sizes listed are for standard nitrile elements, except Models 25 and 62 which have PTFE elements. Other material available on inquiry only.

## Oil Seals by Model Number

Product Code	Model	Inches			MM			Product Code	Model	Inches			MM		
		ID	OD	Width	ID	OD	Width			ID	OD	Width	ID	OD	Width
25003-5587	23-L	61.810	63.810	0.813	1570	1621	21	25003-5699	23-L	19.500	21.250	0.813	495	540	21
25003-5594	23-L	17.719	19.219	0.750	450	488	19	25003-5707	23-L	24.093	26.093	0.812	612	663	21
25003-5595	23-L	23.300	24.300	0.500	592	617	13	25003-5708	23-L	20.516	22.516	0.812	521	572	21
25003-5596	23-L	53.250	54.250	0.500	1353	1378	13	25003-5709	23-L	37.375	39.375	0.812	949	1000	21
25003-5597	23	5.875	7.140	0.563	149	181	14	25003-5712	23	11.220	12.953	0.787	285	329	20
25003-5598	23	8.661	9.661	0.500	220	245	13	25003-5714	23-L	36.000	37.500	0.750	914	953	19
25003-5599	23-L	16.062	17.062	0.500	408	433	13	25003-5716	23	4.342	5.342	0.375	110	136	10
25003-5601	23-L	38.250	40.250	0.813	972	1022	21	25003-5717	23	5.280	6.280	0.500	134	160	13
25003-5602	23-L	34.000	35.500	0.750	864	902	19	25003-5718	23-L	15.359	16.890	0.750	390	429	19
25003-5605	23	7.875	8.875	0.375	200	225	10	25003-5719	23	11.422	12.921	0.750	290	328	19
25003-5606	23	4.312	5.794	0.500	110	147	13	25003-5720	23-L	24.803	26.303	0.750	630	668	19
25003-5611	23-L	31.000	32.000	0.500	787	813	13	25003-5724	23	11.031	12.031	0.625	280	306	16
25003-5612	23-L	28.875	29.750	0.500	733	756	13	25003-5725	23-L	16.531	18.031	0.750	420	458	19
25003-5613	23-L	17.900	19.400	0.750	455	493	19	25003-5726	23	5.750	6.625	0.453	146	168	12
25003-5614	23-L	23.570	25.070	0.750	599	637	19	25003-5727	23-L	44.500	46.500	0.813	1130	1181	21
25003-5615	23-L	23.595	25.095	0.750	599	637	19	25003-5729	23-L	25.125	26.125	0.500	638	664	13
25003-5618	23-L	50.000	51.500	0.750	1270	1308	19	25003-5730	23-L	34.000	35.000	0.500	864	889	13
25003-5619	23-L	21.000	23.000	0.750	533	584	19	25003-5731	23	6.938	8.000	0.625	176	203	16
25003-5622	23-L	37.812	39.812	0.812	960	1011	21	25003-5735	23-L	57.875	58.875	0.500	1470	1495	13
25003-5624	23-L	74.500	76.000	0.750	1892	1930	19	25003-5739	23-L	31.000	32.500	0.750	787	826	19
25003-5625	23-L	40.000	41.500	0.750	1016	1054	19	25003-5740	23-L	21.259	22.759	0.688	540	578	17
25003-5628	23	6.300	7.781	0.500	160	198	13	25003-5743	23-L	25.530	27.030	0.750	648	687	19
25003-5629	23	7.078	8.562	0.500	180	217	13	25003-5744	23-L	47.000	49.000	0.812	1194	1245	21
25003-5634	23-L	53.625	54.625	0.500	1362	1387	13	25003-5745	23	9.125	11.125	0.750	232	283	19
25003-5635	23	4.217	5.280	0.500	107	134	13	25003-5747	23-L	16.500	17.500	0.500	419	445	13
25003-5636	23	5.780	7.030	0.625	147	179	16	25003-5749	23	3.688	4.750	0.375	94	121	10
25003-5637	23	6.280	7.530	0.625	160	191	16	25003-5756	23-L	23.500	24.500	0.500	597	622	13
25003-5638	23	7.530	8.780	0.625	191	223	16	25003-5757	23-L	80.500	82.500	0.813	2045	2096	21
25003-5639	23	10.530	12.030	0.625	267	306	16	25003-5761	23-L	20.866	22.638	0.811	530	575	21
25003-5640	23-L	13.580	14.580	0.500	345	370	13	25003-5763	23	4.134	5.315	0.500	105	135	13
25003-5642	23	11.500	12.625	0.625	292	321	16	25003-5765	23-L	35.000	36.500	0.625	889	927	16
25003-5647	23-L	30.563	32.563	0.813	776	827	21	25003-5768	23-L	21.500	23.000	0.750	546	584	19
25003-5650	23	3.346	4.330	0.500	85	110	13	25003-5769	23-L	18.062	20.062	0.812	459	510	21
25003-5654	23-L	20.469	21.969	0.750	520	558	19	25003-5776	23	11.688	13.188	0.625	297	335	16
25003-5658	23-L	35.750	37.750	0.813	908	959	21	25003-5777	23	3.344	4.437	0.500	85	113	13
25003-5659	23-L	13.563	15.062	0.750	345	383	19	25003-5779	23-L	25.590	26.590	0.500	650	675	13
25003-5661	23	6.062	7.375	0.500	154	187	13	25003-5780	23-L	29.527	30.527	0.500	750	775	13
25003-5662	23-L	36.000	38.000	0.750	914	965	19	25003-5783	23-L	13.125	15.125	0.813	333	384	21
25003-5663	23-L	84.000	86.000	0.500	2134	2184	13	25003-5784	23	9.055	10.551	0.750	230	268	19
25003-5664	23-L	13.386	15.236	0.748	340	387	19	25003-5788	23-L	102.000	104.000	0.812	2591	2642	21
25003-5665	23	10.236	11.732	0.750	260	298	19	25003-5789	23	7.875	8.938	0.500	200	227	13
25003-5666	23-L	15.748	17.244	0.748	400	438	19	25003-5792	23	6.500	7.938	0.625	165	202	16
25003-5667	23-L	12.598	14.094	0.748	320	358	19	25003-5795	23-L	21.250	22.750	0.750	540	578	19
25003-5668	23-L	21.456	23.456	0.813	545	596	21	25003-5796	23-L	79.500	81.500	0.813	2019	2070	21
25003-5669	23-L	12.688	14.688	0.813	322	373	21	25003-5797	23	5.118	5.992	0.375	130	152	10
25003-5670	23	12.000	13.500	0.813	305	343	21	25003-5799	23-L	26.771	27.771	0.500	680	705	13
25003-5680	23-L	18.125	19.625	0.750	460	498	19	25003-5801	23-L	14.960	16.460	0.750	380	418	19
25003-5682	23	3.280	4.280	0.375	83	109	10	25003-5802	23-L	20.078	22.078	0.813	510	561	21
25003-5683	23-L	13.580	15.030	0.750	345	382	19	25003-5803	23-L	16.141	18.141	0.812	410	461	21
25003-5684	23	8.530	9.780	0.625	217	248	16	25003-5804	23-L	42.250	44.250	0.813	1073	1124	21
25003-5685	23	7.960	9.460	0.625	202	240	16	25003-5808	23	10.826	11.826	0.590	275	300	15
25003-5689	23-L	61.000	63.000	0.813	1549	1600	21	25003-5811	23-L	66.500	68.000	0.750	1689	1727	19
25003-5691	23	6.625	8.375	0.500	168	213	13	25003-5815	23-L	14.166	15.750	0.625	360	400	16
25003-5696	23	5.250	6.437	0.500	133	163	13	25003-5818	23-L	24.500	25.500	0.500	622	648	13
25003-5697	23	5.250	6.437	0.375	133	163	10	25003-5819	23-L	16.125	18.125	0.812	410	460	21
25003-5698	23-L	33.000	34.500	0.625	838	876	16	25003-5820	23-L	18.500	19.500	0.500	470	495	13

All dimensions are in inches. Preferred sizes are indicated with **bold** type face.  
 Sizes listed are for standard nitrile elements, except Models 25 and 62 which have PTFE elements. Other material available on inquiry only.

## Oil Seals by Model Number

Product Code	Model	Inches			MM			Product Code	Model	Inches			MM		
		ID	OD	Width	ID	OD	Width			ID	OD	Width	ID	OD	Width
25003-5823	23-L	46.250	48.250	0.813	1175	1226	21	25003-5990	23-L	14.750	16.500	0.687	375	419	17
25003-5825	23-L	13.625	14.875	0.750	346	378	19	25003-6000	23	7.875	9.056	0.375	200	230	10
25003-5827	23-L	16.625	17.625	0.500	422	448	13	25003-6015	23	4.500	5.375	0.500	114	137	13
25003-5829	23-L	42.913	44.913	0.813	1090	1141	21	25003-6016	23	7.813	9.313	0.750	198	237	19
25003-5830	23-L	34.251	36.251	0.813	870	921	21	25003-6052	23	4.134	5.118	0.512	105	130	13
25003-5835	23	11.811	12.811	0.500	300	325	13	25003-6059	23-L	40.000	42.000	0.813	1016	1067	21
25003-5845	23-L	14.567	15.551	0.500	370	395	13	25003-6067	23	9.750	10.750	0.500	248	273	13
25003-5846	23-L	14.173	15.673	0.750	360	398	19	25003-6068	23-L	28.125	29.250	0.500	714	743	13
25003-5847	23-L	31.890	33.890	0.813	810	861	21	25003-6079	23-L	19.250	21.250	0.813	489	540	21
25003-5849	23-L	19.881	21.881	0.812	505	556	21	25003-6084	23	4.656	6.031	0.500	118	153	13
25003-5850	23-L	16.929	18.429	0.750	430	468	19	25003-6087	23	10.938	12.438	0.625	278	316	16
25003-5851	23	11.471	13.471	0.750	291	342	19	25003-6092	23	9.062	11.062	0.750	230	281	19
25003-5852	23	9.448	10.948	0.750	240	278	19	25003-6102	23	3.125	4.125	0.438	79	105	11
25003-5860	23-L	27.952	29.952	0.812	710	761	21	25003-6107	23-L	33.500	35.500	0.813	851	902	21
25003-5861	23	5.511	6.692	0.625	140	170	16	25003-6111	23	3.938	5.062	0.500	100	129	13
25003-5862	23	10.629	12.251	0.625	270	311	16	25003-6121	23	3.250	4.125	0.438	83	105	11
25003-5863	23-L	28.750	29.750	0.500	730	756	13	25003-6128	23	3.313	4.250	0.438	84	108	11
25003-5865	23-L	15.750	17.500	0.812	400	445	21	25003-6129	23	3.938	5.000	0.469	100	127	12
25003-5867	23-L	16.125	17.125	0.500	410	435	13	25003-6130	23-L	76.500	78.500	0.813	1943	1994	21
25003-5872	23	3.938	4.875	0.500	100	124	13	25003-6132	23-L	18.375	19.875	0.750	467	505	19
25003-5873	23-L	41.000	42.500	0.750	1041	1080	19	25003-6136	23	5.188	6.438	0.625	132	164	16
25003-5874	23-L	13.780	15.709	0.787	350	399	20	25003-6142	23	4.125	5.500	0.438	105	140	11
25003-5880	23	4.875	5.938	0.500	124	151	13	25003-6143	23-L	33.750	35.750	0.813	857	908	21
25003-5881	23	10.629	12.119	0.750	270	308	19	25003-6147	23	5.062	6.375	0.563	129	162	14
25003-5882	23	11.417	13.417	0.750	290	341	19	25003-6150	23	5.563	6.750	0.500	141	171	13
25003-5885	23-L	36.000	37.000	0.500	914	940	13	25003-6163	23	7.000	8.375	0.500	178	213	13
25003-5890	23	8.750	9.875	0.625	222	251	16	25003-6164	23	5.875	6.875	0.438	149	175	11
25003-5894	23-L	25.750	27.000	0.625	654	686	16	25003-6165	23	6.000	7.000	0.438	152	178	11
25003-5895	23-L	27.969	29.969	0.813	710	761	21	25003-6168	23-L	13.000	14.825	0.813	330	377	21
25003-5900	23	5.250	6.250	0.437	133	159	11	25003-6172	23	6.625	8.125	0.688	168	206	17
25003-5901	23	9.938	10.938	0.500	252	278	13	25003-6175	23	7.250	8.250	0.438	184	210	11
25003-5902	23-L	58.500	60.500	0.813	1486	1537	21	25003-6182	23	7.375	8.375	0.438	187	213	11
25003-5904	23-L	19.688	21.187	0.750	500	538	19	25003-6185	23	7.750	8.750	0.438	197	222	11
25003-5905	23-L	47.250	49.250	0.813	1200	1251	21	25003-6190	23	8.938	10.188	0.625	227	259	16
25003-5906	23	10.000	12.000	0.688	254	305	17	25003-6191	23-L	22.062	24.062	0.813	560	611	21
25003-5910	23	8.859	10.359	0.750	225	263	19	25003-6198	23	5.125	6.125	0.438	130	156	11
25003-5913	23	3.938	5.000	0.500	100	127	13	25003-6199	23	6.875	8.000	0.438	175	203	11
25003-5916	23	8.500	10.500	0.625	216	267	16	25003-6201	23	9.750	11.160	0.588	248	283	15
25003-5917	23-L	12.750	14.500	0.750	324	368	19	25003-6202	23-L	23.000	24.000	0.500	584	610	13
25003-5919	23-L	24.000	26.000	0.813	610	660	21	25003-6204	23	8.250	9.250	0.438	210	235	11
25003-5931	23	5.313	6.813	0.500	135	173	13	25003-6205	23	3.938	5.313	0.500	100	135	13
25003-5933	23	3.562	4.812	0.500	90	122	13	25003-6210	23	8.687	9.938	0.750	221	252	19
25003-5934	23	10.500	11.750	0.625	267	298	16	25003-6213	23	4.750	5.750	0.375	121	146	10
25003-5935	23-L	35.000	37.000	0.813	889	940	21	25003-6214	23	9.500	10.500	0.438	241	267	11
25003-5936	23-L	21.625	23.625	0.813	549	600	21	25003-6216	23	10.188	11.188	0.500	259	284	13
25003-5939	23-L	12.875	14.375	0.750	327	365	19	25003-6219	23	10.125	11.375	0.625	257	289	16
25003-5942	23-L	12.756	14.252	0.748	324	362	19	25003-6229	23	6.688	7.688	0.500	170	195	13
25003-5952	23	9.000	10.500	0.500	229	267	13	25003-6237	23-L	39.000	41.000	0.813	991	1041	21
25003-5953	23	12.406	13.906	0.750	315	353	19	25003-6238	23	11.188	12.188	0.500	284	310	13
25003-5954	23-L	24.250	25.625	0.563	616	651	14	25003-6247	23	8.250	9.750	0.500	210	248	13
25003-5957	23	10.236	11.486	0.625	260	292	16	25003-6250	23	3.741	5.240	0.500	95	133	13
25003-5959	23	3.875	4.844	0.484	98	123	12	25003-6251	23	7.250	8.750	0.500	184	222	13
25003-5960	23	9.500	11.500	0.688	241	292	17	25003-6253	23	12.188	13.688	0.625	310	348	16
25003-5961	23	9.842	11.467	0.750	250	291	19	25003-6258	23	6.938	8.062	0.500	176	205	13
25003-5983	23-L	17.125	19.125	0.813	435	486	21	25003-6263	23-L	13.250	14.750	0.625	337	375	16
25003-5984	23-L	13.469	14.469	0.500	342	368	13	25003-6264	23-L	13.250	15.250	0.750	337	387	19

All dimensions are in inches. Preferred sizes are indicated with **bold** type face.

Sizes listed are for standard nitrile elements, except Models 25 and 62 which have PTFE elements. Other material available on inquiry only.

## Oil Seals by Model Number

Product Code	Model	Inches			MM			Product Code	Model	Inches			MM		
		ID	OD	Width	ID	OD	Width			ID	OD	Width	ID	OD	Width
25003-6268	23-L	42.500	43.500	0.500	1080	1105	13	25003-6397	23-L	16.250	18.250	0.813	413	464	21
25003-6273	23	8.937	9.968	0.500	227	253	13	25003-6398	23-L	16.750	18.750	0.750	425	476	19
25003-6276	23-L	73.000	75.000	0.812	1854	1905	21	25003-6399	23-L	18.000	20.000	0.813	457	508	21
25003-6283	23-L	14.688	16.188	0.625	373	411	16	25003-6400	23-L	20.000	22.000	0.813	508	559	21
25003-6285	23	3.500	4.375	0.500	89	111	13	25003-6401	23-L	22.000	24.000	0.813	559	610	21
25003-6291	23-L	22.000	23.750	0.813	559	603	21	25003-6402	23	7.125	8.250	0.469	181	210	12
25003-6297	23-L	30.375	32.375	0.812	772	822	21	25003-6403	23-L	29.500	31.500	0.813	749	800	21
25003-6298	23	4.062	5.125	0.469	103	130	12	25003-6404	23-L	30.000	31.125	0.500	762	791	13
25003-6303	23-L	14.000	15.500	0.625	356	394	16	25003-6405	23-L	32.500	33.625	0.500	826	854	13
25003-6321	23-L	25.750	26.875	0.625	654	683	16	25003-6406	23-L	36.000	38.000	0.813	914	965	21
25003-6324	23-L	14.000	15.750	0.500	356	400	13	25003-6407	23-L	42.000	44.000	0.813	1067	1118	21
25003-6328	23	11.875	13.375	0.750	302	340	19	25003-6408	23-L	18.500	20.500	0.813	470	521	21
25003-6332	23-L	26.500	28.500	0.813	673	724	21	25003-6409	23	4.000	5.265	0.500	102	134	13
25003-6334	23	8.812	10.312	0.500	224	262	13	25003-6410	23	4.437	5.687	0.500	113	144	13
25003-6335	23-L	24.438	26.438	0.813	621	672	21	25003-6416	23	10.875	12.875	0.813	276	327	21
25003-6337	23-L	23.625	25.625	0.813	600	651	21	25003-6419	23-L	25.000	27.000	0.813	635	686	21
25003-6348	23-L	45.000	47.000	0.813	1143	1194	21	25003-6420	23-L	34.500	36.500	0.813	876	927	21
25003-6351	23	2.938	3.938	0.500	75	100	13	25003-6423	23	9.000	10.125	0.547	229	257	14
25003-6353	23-L	15.785	17.785	0.813	401	452	21	25003-6424	23-L	70.000	72.000	0.813	1778	1829	21
25003-6355	23	3.438	4.438	0.500	87	113	13	25003-6426	23-L	19.750	21.750	0.813	502	552	21
25003-6356	23	3.250	4.250	0.375	83	108	10	25003-6428	23	10.625	12.625	0.813	270	321	21
25003-6357	23	3.438	4.688	0.500	87	119	13	25003-6431	23	4.750	5.875	0.563	121	149	14
25003-6358	23	3.500	4.500	0.375	89	114	10	25003-6441	23	12.208	13.703	0.750	310	348	19
25003-6359	23	3.625	4.625	0.375	92	117	10	25003-6450	23	6.250	7.250	0.438	159	184	11
25003-6360	23	4.000	5.000	0.375	102	127	10	25003-6453	23	5.000	6.500	0.375	127	165	10
25003-6361	23	4.250	5.375	0.406	108	137	10	25003-6455	23-L	15.630	17.126	0.748	397	435	19
25003-6362	23	4.438	5.438	0.500	113	138	13	25003-6464	23	3.813	4.813	0.500	97	122	13
25003-6363	23	4.500	5.500	0.375	114	140	10	25003-6471	23	2.750	3.750	0.500	70	95	13
25003-6364	23	4.688	5.813	0.500	119	148	13	25003-6473	23-L	38.500	40.500	0.813	978	1029	21
25003-6365	23	5.000	6.000	0.375	127	152	10	25003-6474	23	5.750	6.968	0.500	146	177	13
25003-6366	23	5.250	6.750	0.750	133	171	19	25003-6483	23-L	26.000	28.000	0.813	660	711	21
25003-6367	23	5.438	6.688	0.625	138	170	16	25003-6484	23-L	12.125	14.125	0.750	308	359	19
25003-6368	23	5.625	7.125	0.750	143	181	19	25003-6485	23	5.063	6.062	0.500	129	154	13
25003-6370	23	6.500	8.000	0.500	165	203	13	25003-6491	23	4.813	5.813	0.500	122	148	13
25003-6371	23	6.563	7.563	0.500	167	192	13	25003-6492	23	7.875	8.875	0.500	200	225	13
25003-6372	23	6.750	7.750	0.500	171	197	13	25003-6504	23	10.938	12.938	0.750	278	329	19
25003-6373	23	6.938	7.938	0.500	176	202	13	25003-6508	23-L	19.000	21.000	0.813	483	533	21
25003-6374	23	7.000	8.000	0.500	178	203	13	25003-6510	23	8.000	9.250	0.500	203	235	13
25003-6375	23	7.000	8.500	0.500	178	216	13	25003-6512	23-L	45.125	47.125	0.813	1146	1197	21
25003-6376	23	7.250	8.250	0.500	184	210	13	25003-6515	23-L	13.850	15.500	0.750	352	394	19
25003-6377	23	7.250	8.500	0.500	184	216	13	25003-6518	23-L	13.980	15.500	0.750	355	394	19
25003-6378	23	7.500	8.500	0.500	191	216	13	25003-6525	23	4.688	5.688	0.500	119	144	13
25003-6379	23	7.750	8.750	0.500	197	222	13	25003-6531	23-L	15.156	17.156	0.813	385	436	21
25003-6380	23	8.000	9.000	0.500	203	229	13	25003-6532	23	5.438	6.656	0.463	138	169	12
25003-6382	23	8.250	9.250	0.500	210	235	13	25003-6535	23-L	21.000	23.000	0.813	533	584	21
25003-6384	23	8.500	9.750	0.625	216	248	16	25003-6539	23-L	25.750	27.000	0.500	654	686	13
25003-6387	23	9.000	10.000	0.500	229	254	13	25003-6540	23	5.500	6.765	0.500	140	172	13
25003-6388	23	9.500	10.500	0.500	241	267	13	25003-6542	23-L	21.437	23.437	0.812	544	595	21
25003-6389	23	9.625	11.625	0.750	244	295	19	25003-6544	23	4.625	5.625	0.375	117	143	10
25003-6390	23	9.750	11.000	0.500	248	279	13	25003-6549	23	11.375	12.375	0.500	289	314	13
25003-6391	23	10.000	11.000	0.500	254	279	13	25003-6556	23	7.250	8.438	0.590	184	214	15
25003-6392	23	5.125	6.125	0.422	130	156	11	25003-6560	23-L	14.000	15.000	0.500	356	381	13
25003-6393	23	11.000	12.125	0.547	279	308	14	25003-6561	23	4.938	5.938	0.500	125	151	13
25003-6394	23	11.000	12.500	0.750	279	318	19	25003-6562	23-L	15.500	17.250	0.750	394	438	19
25003-6395	23	11.000	13.000	0.750	279	330	19	25003-6565	23-L	49.500	51.500	0.813	1257	1308	21
25003-6396	23-L	12.750	14.750	0.750	324	375	19	25003-6568	23	10.441	11.441	0.375	265	291	10

All dimensions are in inches. Preferred sizes are indicated with **bold** type face. Sizes listed are for standard nitrile elements, except Models 25 and 62 which have PTFE elements. Other material available on inquiry only.

## Oil Seals by Model Number

Product Code	Model	Inches			MM			Product Code	Model	Inches			MM		
		ID	OD	Width	ID	OD	Width			ID	OD	Width	ID	OD	Width
25003-6570	23	8.625	9.875	0.625	219	251	16	25003-6783	23	4.188	5.438	0.500	106	138	13
25003-6574	23	5.500	6.750	0.750	140	171	19	25003-6786	23-L	28.000	30.000	0.813	711	762	21
25003-6578	23	4.125	5.188	0.500	105	132	13	25003-6797	23	8.938	10.000	0.500	227	254	13
25003-6579	23	5.225	6.225	0.500	133	158	13	25003-6801	23	4.500	5.938	0.500	114	151	13
25003-6582	23-L	53.000	54.875	0.813	1346	1394	21	25003-6803	23-L	28.750	30.750	0.813	730	781	21
25003-6587	23	4.500	5.512	0.375	114	140	10	25003-6805	23-L	32.750	34.750	0.813	832	883	21
25003-6595	23	9.250	10.750	0.625	235	273	16	25003-6807	23-L	21.500	22.750	0.750	546	578	19
25003-6597	23	6.906	8.156	0.625	175	207	16	25003-6812	23-L	17.322	18.822	0.750	440	478	19
25003-6601	23-L	16.625	18.625	0.813	422	473	21	25003-6813	23	8.875	9.875	0.500	225	251	13
25003-6602	23	6.125	7.625	0.625	156	194	16	25003-6817	23	6.500	7.750	0.500	165	197	13
25003-6609	23-L	32.000	33.125	0.500	813	841	13	25003-6818	23	6.690	7.940	0.625	170	202	16
25003-6615	23-L	17.750	19.250	0.750	451	489	19	25003-6819	23-L	26.815	28.815	0.812	681	732	21
25003-6616	23	4.062	5.313	0.500	103	135	13	25003-6820	23	4.331	5.831	0.500	110	148	13
25003-6618	23-L	15.250	17.250	0.625	387	438	16	25003-6821	23-L	16.000	17.750	0.750	406	451	19
25003-6619	23	3.750	4.875	0.375	95	124	10	25003-6822	23-L	36.750	38.750	0.813	933	984	21
25003-6621	23	11.500	12.750	0.500	292	324	13	25003-6823	23-L	25.196	26.696	0.750	640	678	19
25003-6622	23	5.375	6.375	0.375	137	162	10	25003-6826	23	11.750	13.500	0.750	298	343	19
25003-6625	23	4.125	5.125	0.375	105	130	10	25003-6827	23	8.750	9.750	0.500	222	248	13
25003-6626	23-L	17.125	18.625	0.750	435	473	19	25003-6829	23-L	12.250	14.250	0.750	311	362	19
25003-6638	23	4.920	6.125	0.438	125	156	11	25003-6830	23-L	20.472	21.972	0.750	520	558	19
25003-6646	23	8.875	10.875	0.750	225	276	19	25003-6836	23	11.750	13.750	0.750	298	349	19
25003-6648	23	9.375	10.625	0.625	238	270	16	25003-6839	23	3.250	4.250	0.438	83	108	11
25003-6653	23-L	59.750	60.750	0.500	1518	1543	13	25003-6840	23	11.688	13.250	0.625	297	337	16
25003-6657	23-L	16.250	18.250	0.750	413	464	19	25003-6841	23	7.078	8.578	0.625	180	218	16
25003-6664	23	9.625	10.875	0.500	244	276	13	25003-6844	23	7.875	9.000	0.500	200	229	13
25003-6669	23	9.500	10.625	0.500	241	270	13	25003-6845	23	8.750	10.250	0.500	222	260	13
25003-6671	23-L	48.000	50.000	0.813	1219	1270	21	25003-6849	23-L	30.000	32.000	0.813	762	813	21
25003-6672	23	11.250	12.500	0.625	286	318	16	25003-6851	23	4.313	5.188	0.375	110	132	10
25003-6676	23	9.250	10.250	0.500	235	260	13	25003-6853	23-L	21.500	23.000	0.625	546	584	16
25003-6677	23-L	30.750	31.750	0.500	781	806	13	25003-6861	23	7.250	8.250	0.375	184	210	10
25003-6683	23	10.500	12.000	0.500	267	305	13	25003-6862	23	3.125	4.250	0.375	79	108	10
25003-6684	23	8.250	9.750	0.625	210	248	16	25003-6867	23	6.299	7.549	0.625	160	192	16
25003-6687	23	11.500	13.000	0.625	292	330	16	25003-6868	23	3.000	4.125	0.375	76	105	10
25003-6697	23-L	16.500	18.500	0.750	419	470	19	25003-6870	23	4.125	5.000	0.500	105	127	13
25003-6698	23	10.250	11.500	0.625	260	292	16	25003-6873	23-L	15.750	16.750	0.500	400	425	13
25003-6704	23	10.625	12.625	0.750	270	321	19	25003-6877	23-L	14.000	16.000	0.750	356	406	19
25003-6705	23	11.875	12.875	0.500	302	327	13	25003-6878	23-L	16.125	18.125	0.750	410	460	19
25003-6709	23	3.938	4.938	0.375	100	125	10	25003-6879	23-L	23.500	25.500	0.813	597	648	21
25003-6710	23-L	20.125	22.125	0.813	511	562	21	25003-6882	23	10.375	11.875	0.500	264	302	13
25003-6713	23-L	35.125	36.250	0.500	892	921	13	25003-6883	23-L	15.125	17.125	0.625	384	435	16
25003-6718	23-L	20.125	22.125	0.750	511	562	19	25003-6885	23-L	43.500	45.000	0.750	1105	1143	19
25003-6719	23	11.906	13.156	0.625	302	334	16	25003-6888	23	7.312	8.438	0.562	186	214	14
25003-6728	23	5.750	6.938	0.500	146	176	13	25003-6889	23-L	45.748	47.520	0.787	1162	1207	20
25003-6740	23-L	18.375	20.375	0.813	467	518	21	25003-6890	23	6.750	7.875	0.500	171	200	13
25003-6748	23	4.531	5.531	0.500	115	140	13	25003-6891	23-L	39.000	40.747	0.787	991	1035	20
25003-6752	23	3.344	4.344	0.500	85	110	13	25003-6894	23-L	33.465	35.236	0.787	850	895	20
25003-6754	23	4.938	5.938	0.375	125	151	10	25003-6896	23	3.740	4.740	0.500	95	120	13
25003-6756	23	9.125	10.125	0.500	232	257	13	25003-6897	23	6.625	7.625	0.500	168	194	13
25003-6759	23	7.750	9.000	0.500	197	229	13	25003-6905	23-L	80.000	82.000	0.812	2032	2083	21
25003-6769	23-L	15.750	17.750	0.813	400	451	21	25003-6907	23-L	29.906	31.906	0.812	760	810	21
25003-6772	23-L	23.500	25.500	0.750	597	648	19	25003-6908	23-L	34.500	36.000	0.750	876	914	19
25003-6773	23	7.500	9.000	0.500	191	229	13	25003-6910	23-L	23.250	25.250	0.813	591	641	21
25003-6775	23-L	51.000	53.000	0.813	1295	1346	21	25003-6915	23-L	65.000	67.000	0.812	1651	1702	21
25003-6778	23-L	14.063	16.062	0.812	357	408	21	25003-6918	23-L	25.500	27.500	0.750	648	699	19
25003-6781	23	10.500	11.500	0.500	267	292	13	25003-6919	23	4.375	5.875	0.375	111	149	10
25003-6782	23-L	12.875	14.750	0.813	327	375	21	25003-6922	23	6.281	7.280	0.375	160	185	10

All dimensions are in inches. Preferred sizes are indicated with **bold** type face.

Sizes listed are for standard nitrile elements, except Models 25 and 62 which have PTFE elements. Other material available on inquiry only.

## Oil Seals by Model Number

Product Code	Model	Inches			MM			Product Code	Model	Inches			MM		
		ID	OD	Width	ID	OD	Width			ID	OD	Width	ID	OD	Width
25003-6923	23	3.563	4.625	0.375	91	117	10	25003-7157	23	8.250	9.750	0.750	210	248	19
25003-6924	23	5.750	7.000	0.375	146	178	10	25003-7161	23-L	30.500	32.500	0.750	775	826	19
25003-6926	23	7.874	9.291	0.748	200	236	19	25003-7162	23-L	23.250	24.750	0.750	591	629	19
25003-6932	23	11.811	13.311	0.750	300	338	19	25003-7172	23	5.750	6.750	0.438	146	171	11
25003-6933	23-L	16.929	17.929	0.500	430	455	13	25003-7175	23-L	13.750	14.750	0.500	349	375	13
25003-6935	23	10.625	12.000	0.750	270	305	19	25003-7180	23	7.500	8.750	0.500	191	222	13
25003-6939	23	5.000	6.500	0.750	127	165	19	25003-7199	23-L	42.500	44.500	0.750	1080	1130	19
25003-6943	23	8.813	9.813	0.500	224	249	13	25003-7200	23-L	24.750	26.750	0.813	629	679	21
25003-6947	23-L	33.000	34.125	0.500	838	867	13	25003-7204	23	11.000	12.625	0.750	279	321	19
25003-6951	23	6.875	8.000	0.500	175	203	13	25003-7205	23	4.500	5.625	0.375	114	143	10
25003-6957	23	4.328	5.203	0.375	110	132	10	25003-7212	23-L	20.000	22.000	0.750	508	559	19
25003-6960	23	3.750	4.813	0.500	95	122	13	25003-7213	23	3.125	3.875	0.375	79	98	10
25003-6964	23	11.023	12.023	0.500	280	305	13	25003-7214	23	5.938	7.437	0.750	151	189	19
25003-6965	23-L	24.625	25.875	0.563	625	657	14	25003-7219	23	11.500	13.000	0.500	292	330	13
25003-6967	23-L	17.250	18.750	0.750	438	476	19	25003-7221	23	5.118	6.299	0.511	130	160	13
25003-6972	23-L	21.750	23.750	0.813	552	603	21	25003-7227	23-L	50.000	51.000	0.500	1270	1295	13
25003-6973	23	7.875	9.875	0.625	200	251	16	25003-7239	23-L	15.375	16.875	0.750	391	429	19
25003-6982	23	6.102	7.102	0.500	155	180	13	25003-7244	23-L	33.000	35.000	0.813	838	889	21
25003-6984	23-L	16.375	17.375	0.500	416	441	13	25003-7250	23	12.062	13.563	0.750	306	345	19
25003-6987	23-L	24.500	26.250	0.813	622	667	21	25003-7251	23-L	27.500	29.500	0.813	699	749	21
25003-6989	23-L	58.000	60.000	0.750	1473	1524	19	25003-7253	23	3.500	5.000	0.500	89	127	13
25003-6991	23	9.448	10.448	0.500	240	265	13	25003-7263	23	11.500	12.750	0.625	292	324	16
25003-6992	23	4.331	5.906	0.625	110	150	16	25003-7264	23	6.250	7.688	0.625	159	195	16
25003-6998	23-L	25.750	27.250	0.750	654	692	19	25003-7267	23	5.512	6.693	0.591	140	170	15
25003-7010	23	10.236	11.811	0.630	260	300	16	25003-7268	23	6.693	7.875	0.591	170	200	15
25003-7015	23-L	63.500	65.500	0.812	1613	1664	21	25003-7271	23	4.528	5.512	0.472	115	140	12
25003-7018	23-L	48.875	50.875	0.813	1241	1292	21	25003-7274	23	6.875	8.125	0.500	175	206	13
25003-7019	23-L	13.622	15.122	0.750	346	384	19	25003-7275	23	5.813	6.938	0.500	148	176	13
25003-7036	23	3.938	4.813	0.375	100	122	10	25003-7276	23	6.299	7.480	0.591	160	190	15
25003-7039	23-L	29.375	31.375	0.813	746	797	21	25003-7277	23	4.724	5.906	0.591	120	150	15
25003-7053	23	11.625	12.625	0.500	295	321	13	25003-7279	23-L	12.625	14.625	0.750	321	371	19
25003-7059	23-L	18.500	20.500	0.750	470	521	19	25003-7281	23-L	18.898	20.472	0.787	480	520	20
25003-7063	23	6.781	8.031	0.625	172	204	16	25003-7284	23-L	22.834	24.334	0.750	580	618	19
25003-7075	23	3.438	4.438	0.375	87	113	10	25003-7288	23	10.433	11.683	0.625	265	297	16
25003-7098	23-L	22.813	24.313	0.750	579	618	19	25003-7291	23-L	94.000	96.000	0.813	2388	2438	21
25003-7101	23	8.500	10.500	0.750	216	267	19	25003-7298	23	5.938	6.938	0.500	151	176	13
25003-7102	23-L	49.250	51.250	0.813	1251	1302	21	25003-7306	23	12.000	13.250	0.625	305	337	16
25003-7107	23-L	29.133	31.133	0.813	740	791	21	25003-7320	23	7.667	9.055	0.591	195	230	15
25003-7108	23	7.875	9.125	0.375	200	232	10	25003-7321	23	6.438	7.438	0.500	164	189	13
25003-7117	23	5.906	7.410	0.625	150	188	16	25003-7322	23	9.062	10.062	0.500	230	256	13
25003-7119	23-L	24.016	25.984	0.811	610	660	21	25003-7323	23-L	13.375	14.875	0.750	340	378	19
25003-7123	23	4.063	5.063	0.500	103	129	13	25003-7331	23-L	29.000	31.000	0.813	737	787	21
25003-7124	23	5.375	6.875	0.750	137	175	19	25003-7334	23-L	98.750	100.750	0.813	2508	2559	21
25003-7127	23-L	16.535	18.035	0.750	420	458	19	25003-7336	23	8.875	10.375	0.750	225	264	19
25003-7129	23	4.188	5.375	0.470	106	137	12	25003-7340	23-L	27.000	29.000	0.813	686	737	21
25003-7131	23-L	22.000	23.000	0.500	559	584	13	25003-7344	23	8.375	9.500	0.625	213	241	16
25003-7132	23	5.313	6.313	0.500	135	160	13	25003-7352	23-L	24.250	26.250	0.813	616	667	21
25003-7133	23	7.938	9.438	0.750	202	240	19	25003-7355	23-L	31.750	33.750	0.812	806	857	21
25003-7135	23	12.625	13.875	0.625	321	352	16	25003-7356	23-L	22.625	24.625	0.813	575	625	21
25003-7137	23-L	96.620	98.620	0.813	2454	2505	21	25003-7362	23	5.687	6.937	0.500	144	176	13
25003-7138	23-L	34.000	36.000	0.813	864	914	21	25003-7367	23	7.625	8.625	0.500	194	219	13
25003-7139	23-L	23.375	25.375	0.813	594	645	21	25003-7374	23	3.250	4.250	0.500	83	108	13
25003-7144	23	3.071	4.071	0.500	78	103	13	25003-7376	23	4.724	5.910	0.472	120	150	12
25003-7147	23	10.125	11.500	0.750	257	292	19	25003-7378	23	6.938	8.438	0.500	176	214	13
25003-7148	23-L	20.750	22.750	0.813	527	578	21	25003-7379	23-L	13.875	15.375	0.750	352	391	19
25003-7149	23-L	14.500	16.000	0.625	368	406	16	25003-7383	23	5.512	6.693	0.551	140	170	14

All dimensions are in inches. Preferred sizes are indicated with **bold** type face. Sizes listed are for standard nitrile elements, except Models 25 and 62 which have PTFE elements. Other material available on inquiry only.

## Oil Seals by Model Number

Product Code	Model	Inches			MM			Product Code	Model	Inches			MM		
		ID	OD	Width	ID	OD	Width			ID	OD	Width	ID	OD	Width
25003-7387	23-L	32.500	34.500	0.813	826	876	21	25003-7621	23	9.875	10.875	0.500	251	276	13
25003-7388	23	7.875	9.055	0.591	200	230	15	25003-7624	23-L	87.000	89.000	0.813	2210	2261	21
25003-7389	23	3.750	4.750	0.375	95	121	10	25003-7625	23-L	17.500	19.500	0.750	445	495	19
25003-7391	23	11.024	12.598	0.787	280	320	20	25003-7639	23	11.500	12.375	0.375	292	314	10
25003-7394	23	3.346	4.724	0.472	85	120	12	25003-7640	23	9.250	10.125	0.375	235	257	10
25003-7396	23	4.331	5.512	0.472	110	140	12	25003-7642	23	3.375	4.250	0.500	86	108	13
25003-7407	23-L	21.500	23.500	0.813	546	597	21	25003-7643	23-L	69.000	71.000	0.813	1753	1803	21
25003-7412	23-L	31.000	33.000	0.813	787	838	21	25003-7644	23-L	31.500	33.500	0.813	800	851	21
25003-7413	23-L	18.000	19.750	0.813	457	502	21	25003-7646	23-L	25.438	27.188	0.750	646	691	19
25003-7414	23-L	23.375	24.875	0.750	594	632	19	25003-7647	23	5.938	7.188	0.500	151	183	13
25003-7416	23	3.938	5.438	0.500	100	138	13	25003-7655	23-L	28.500	30.500	0.813	724	775	21
25003-7425	23-L	15.938	17.938	0.750	405	456	19	25003-7656	23	3.188	4.188	0.375	81	106	10
25003-7426	23	3.150	4.331	0.472	80	110	12	25003-7661	23	7.938	8.938	0.500	202	227	13
25003-7431	23-L	15.500	17.500	0.750	394	445	19	25003-7674	23	7.063	8.063	0.500	179	205	13
25003-7432	23	10.625	11.875	0.625	270	302	16	25003-7695	23-L	35.500	37.500	1.000	902	953	25
25003-7437	23	11.365	12.625	0.625	289	321	16	25003-7699	23-L	26.125	28.125	0.813	664	714	21
25003-7438	23	3.437	4.437	0.437	87	113	11	25003-7709	23	10.629	11.629	0.409	270	295	10
25003-7441	23-L	32.000	34.000	0.813	813	864	21	25003-7710	23-L	26.000	28.000	0.750	660	711	19
25003-7442	23-L	15.750	17.500	0.750	400	445	19	25003-7714	23-L	23.110	24.610	0.750	587	625	19
25003-7443	23	7.438	8.500	0.625	189	216	16	25003-7716	23	11.000	12.500	0.500	279	318	13
25003-7444	23	5.688	7.000	0.625	144	178	16	25003-7719	23	6.188	7.438	0.500	157	189	13
25003-7446	23-L	20.032	21.654	0.813	509	550	21	25003-7736	23	10.000	11.125	0.547	254	283	14
25003-7447	23	9.438	10.625	0.625	240	270	16	25003-7740	23	7.125	8.250	0.500	181	210	13
25003-7464	23	3.740	4.990	0.500	95	127	13	25003-7744	23	7.750	8.938	0.625	197	227	16
25003-7469	23-L	24.500	25.625	0.625	622	651	16	25003-7746	23	3.875	4.750	0.375	98	121	10
25003-7470	23-L	39.500	40.500	0.500	1003	1029	13	25003-7751	23-L	38.000	39.000	0.500	965	991	13
25003-7472	23	6.188	7.500	0.625	157	191	16	25003-7755	23-L	50.500	52.500	0.813	1283	1334	21
25003-7481	23	5.938	7.188	0.625	151	183	16	25003-7758	23	8.000	9.500	0.500	203	241	13
25003-7482	23	4.332	5.250	0.375	110	133	10	25003-7771	23	6.500	7.688	0.625	165	195	16
25003-7487	23-L	18.000	19.000	0.500	457	483	13	25003-7773	23-L	30.250	32.250	0.813	768	819	21
25003-7489	23-L	22.500	24.500	0.813	572	622	21	25003-7785	23-L	56.250	58.125	0.813	1429	1476	21
25003-7507	23	5.800	6.800	0.500	147	173	13	25003-7795	23	4.750	6.000	0.375	121	152	10
25003-7539	23-L	15.250	17.250	0.750	387	438	19	25003-7801	23-L	15.250	16.750	0.750	387	425	19
25003-7543	23-L	47.375	48.875	0.750	1203	1241	19	25003-7804	23	8.688	9.938	0.625	221	252	16
25003-7544	23-L	60.000	61.500	0.750	1524	1562	19	25003-7805	23-L	13.000	14.500	0.625	330	368	16
25003-7547	23-L	13.000	14.750	0.750	330	375	19	25003-7807	23	7.086	8.267	0.591	180	210	15
25003-7548	23-L	38.000	39.500	0.750	965	1003	19	25003-7811	23	7.188	8.686	0.625	183	221	16
25003-7570	23	12.125	13.625	0.750	308	346	19	25003-7812	23	7.188	8.188	0.500	183	208	13
25003-7577	23	8.000	9.125	0.500	203	232	13	25003-7813	23-L	36.500	38.500	0.813	927	978	21
25003-7578	23	3.500	4.750	0.375	89	121	10	25003-7814	23-L	15.188	17.188	0.750	386	437	19
25003-7583	23-L	76.000	78.000	0.813	1930	1981	21	25003-7816	23	6.299	7.480	0.511	160	190	13
25003-7587	23	4.734	5.984	0.500	120	152	13	25003-7821	23	4.438	5.813	0.500	113	148	13
25003-7588	23	10.188	11.438	0.625	259	291	16	25003-7825	23-L	49.250	51.125	0.813	1251	1299	21
25003-7589	23-L	17.625	18.525	0.500	448	471	13	25003-7827	23-L	43.000	45.000	0.813	1092	1143	21
25003-7590	23	4.250	5.250	0.375	108	133	10	25003-7830	23-L	49.500	51.250	0.813	1257	1302	21
25003-7591	23	3.313	4.313	0.375	84	110	10	25003-7831	23	9.250	10.625	0.750	235	270	19
25003-7592	23-L	15.565	16.565	0.500	395	421	13	25003-7832	23	11.250	12.750	0.625	286	324	16
25003-7593	23-L	23.000	24.250	0.750	584	616	19	25003-7833	23	2.938	3.688	0.375	75	94	10
25003-7594	23-L	23.750	25.250	0.750	603	641	19	25003-7835	23	9.625	10.500	0.500	244	267	13
25003-7596	23	2.938	3.938	0.375	75	100	10	25003-7836	23	4.724	6.299	0.472	120	160	12
25003-7597	23	6.313	7.313	0.625	160	186	16	25003-7838	23-L	23.000	25.000	0.813	584	635	21
25003-7598	23	10.750	11.750	0.500	273	298	13	25003-7839	23	3.543	4.724	0.472	90	120	12
25003-7600	23	12.750	13.750	0.500	324	349	13	25003-7841	23	3.313	4.313	0.500	84	110	13
25003-7601	23-L	16.000	17.406	0.609	406	442	15	25003-7848	23	11.024	12.598	0.630	280	320	16
25003-7602	23-L	13.125	15.125	0.750	333	384	19	25003-7849	23-L	14.173	15.748	0.630	360	400	16
25003-7618	23-L	18.250	20.250	0.813	464	514	21	25003-7857	23	4.813	5.938	0.375	122	151	10

All dimensions are in inches. Preferred sizes are indicated with **bold** type face.

Sizes listed are for standard nitrile elements, except Models 25 and 62 which have PTFE elements. Other material available on inquiry only.

## Oil Seals by Model Number

Product Code	Model	Inches			MM			Product Code	Model	Inches			MM		
		ID	OD	Width	ID	OD	Width			ID	OD	Width	ID	OD	Width
25003-7858	23-L	15.750	17.250	0.563	400	438	14	25003-8261	23	12.795	13.669	0.375	325	347	10
25003-7859	23-L	25.250	27.250	0.813	641	692	21	25003-8271	23-L	14.875	16.875	0.813	378	429	21
25003-7863	23-L	38.000	40.000	0.813	965	1016	21	25003-8276	23	2.344	3.219	0.625	60	82	16
25003-7867	23	4.938	6.438	0.500	125	164	13	25003-8279	23-L	76.250	78.250	0.813	1937	1988	21
25003-7869	23	8.125	9.188	0.500	206	233	13	25003-8281	23-L	14.875	16.375	0.750	378	416	19
25003-7871	23-L	81.000	83.000	0.813	2057	2108	21	25003-8285	23-L	23.125	24.625	0.618	587	625	16
25003-7874	23	11.732	12.606	0.375	298	320	10	25003-8287	23	11.625	13.125	0.750	295	333	19
25003-7878	23	11.029	12.029	0.375	280	306	10	25003-8295	23-L	16.750	18.250	0.750	425	464	19
25003-7889	23	9.625	10.625	0.500	244	270	13	25003-8299	23-L	18.898	20.866	0.787	480	530	20
25003-7890	23	9.055	10.629	0.551	230	270	14	25003-8313	23	9.625	10.875	0.625	244	276	16
25003-7891	23	9.449	11.024	0.630	240	280	16	25003-8315	23	11.750	13.750	0.813	298	349	21
25003-7893	23	11.811	13.386	0.630	300	340	16	25003-8324	23-L	64.000	66.000	0.813	1626	1676	21
25003-7896	23-L	13.386	14.961	0.630	340	380	16	25003-8332	23-L	13.188	14.188	0.500	335	360	13
25003-7898	23-L	14.214	16.214	0.813	361	412	21	25003-8334	23	10.500	11.750	0.500	267	298	13
25003-7899	23-L	25.750	26.875	0.547	654	683	14	25003-8385	23	2.938	4.000	0.375	75	102	10
25003-7900	23-L	28.375	29.500	0.500	721	749	13	25003-8388	23	9.500	11.000	0.500	241	279	13
25003-7911	23-L	60.000	62.000	0.813	1524	1575	21	25003-8402	23	4.813	5.813	0.375	122	148	10
25003-7924	23	6.438	7.688	0.625	164	195	16	25003-8418	23	8.188	9.188	0.500	208	233	13
25003-7941	23	3.000	3.938	0.375	76	100	10	25003-8420	23	7.874	9.448	0.629	200	240	16
25003-7968	23	3.625	4.724	0.500	92	120	13	25003-8421	23-L	20.000	21.000	0.500	508	533	13
25003-7979	23	3.938	5.118	0.500	100	130	13	25003-8429	23	3.543	4.724	0.500	90	120	13
25003-8043	23-L	27.000	28.000	0.500	686	711	13	25003-8433	23	6.875	7.875	0.500	175	200	13
25003-8049	23	7.480	8.661	0.591	190	220	15	25003-8434	23	7.000	8.406	0.588	178	214	15
25003-8058	23-L	53.000	55.000	0.813	1346	1397	21	25003-8444	23	4.438	5.687	0.625	113	144	16
25003-8103	23-L	27.250	29.250	0.813	692	743	21	25003-8445	23	6.692	8.192	0.750	170	208	19
25003-8108	23-L	23.875	24.875	0.500	606	632	13	25003-8446	23-L	19.500	21.500	0.813	495	546	21
25003-8115	23-L	12.875	14.875	0.750	327	378	19	25003-8447	23	9.438	10.688	0.625	240	271	16
25003-8119	23-L	14.750	16.250	0.625	375	413	16	25003-8451	23	8.250	9.500	0.500	210	241	13
25003-8122	23-L	32.688	34.688	0.813	830	881	21	25003-8452	23	8.375	9.875	0.500	213	251	13
25003-8123	23-L	15.000	16.750	0.813	381	425	21	25003-8455	23	4.563	5.813	0.500	116	148	13
25003-8134	23	6.875	8.125	0.563	175	206	14	25003-8468	23-L	23.188	25.188	0.813	589	640	21
25003-8137	23	5.125	6.625	0.750	130	168	19	25003-8476	23-L	17.500	19.250	0.625	445	489	16
25003-8140	23	9.960	10.834	0.375	253	275	10	25003-8481	23	8.859	9.842	0.492	225	250	12
25003-8142	23	8.750	10.250	0.625	222	260	16	25003-8483	23	3.938	4.906	0.484	100	125	12
25003-8159	23	3.688	4.938	0.500	94	125	13	25003-8488	23	2.938	3.906	0.484	75	99	12
25003-8169	23	6.125	7.625	0.500	156	194	13	25003-8490	23	4.438	5.890	0.484	113	150	12
25003-8171	23	6.500	7.875	0.472	165	200	12	25003-8494	23	9.000	10.500	0.609	229	267	15
25003-8172	23-L	36.460	38.460	0.813	926	977	21	25003-8504	23-L	16.535	18.110	0.787	420	460	20
25003-8175	23	8.125	9.125	0.500	206	232	13	25003-8509	23-L	39.750	41.750	0.813	1010	1060	21
25003-8177	23	8.875	10.375	0.500	225	264	13	25003-8511	23-L	12.906	14.906	0.750	328	379	19
25003-8179	23	9.250	10.750	0.500	235	273	13	25003-8512	23-L	22.250	24.250	0.813	565	616	21
25003-8189	23	8.469	9.968	0.750	215	253	19	25003-8525	23	11.811	13.543	0.807	300	344	20
25003-8190	23-L	27.750	29.750	0.813	705	756	21	25003-8526	23-L	22.750	24.750	0.813	578	629	21
25003-8191	23-L	17.250	19.250	0.813	438	489	21	25003-8534	23	4.438	5.875	0.375	113	149	10
25003-8194	23	6.313	7.313	0.500	160	186	13	25003-8549	23-L	32.125	33.625	0.625	816	854	16
25003-8198	23-L	50.000	52.000	0.875	1270	1321	22	25003-8550	23-L	32.250	33.625	0.625	819	854	16
25003-8200	23-L	35.438	37.438	0.813	900	951	21	25003-8559	23	11.563	13.062	0.750	294	332	19
25003-8210	23-L	45.250	47.125	0.813	1149	1197	21	25003-8560	23	8.500	10.500	0.500	216	267	13
25003-8215	23	5.188	6.438	0.500	132	164	13	25003-8563	23-L	66.000	68.000	0.813	1676	1727	21
25003-8223	23	8.500	10.375	0.625	216	264	16	25003-8565	23	10.500	11.750	0.750	267	298	19
25003-8228	23-L	47.750	49.750	0.813	1213	1264	21	25003-8567	23	6.625	8.000	0.500	168	203	13
25003-8229	23	12.500	13.750	0.625	318	349	16	25003-8575	23	5.438	6.938	0.625	138	176	16
25003-8233	23	3.250	4.249	0.375	83	108	10	25003-8576	23-L	13.000	14.000	0.500	330	356	13
25003-8234	23	8.188	9.313	0.500	208	237	13	25003-8578	23	7.813	8.813	0.500	198	224	13
25003-8242	23	4.724	5.906	0.433	120	150	11	25003-8580	23	7.188	8.639	0.625	183	219	16
25003-8252	23	7.500	8.375	0.500	191	213	13	25003-8583	23	8.500	9.375	0.500	216	238	13

All dimensions are in inches. Preferred sizes are indicated with **bold** type face. Sizes listed are for standard nitrile elements, except Models 25 and 62 which have PTFE elements. Other material available on inquiry only.



## Oil Seals by Model Number

Product Code	Model	Inches			MM			Product Code	Model	Inches			MM		
		ID	OD	Width	ID	OD	Width			ID	OD	Width	ID	OD	Width
25003-8588	23-L	30.000	31.125	0.563	762	791	14	25003-8946	23-L	21.250	22.250	0.500	540	565	13
25003-8589	23-L	12.500	14.062	0.750	318	357	19	25003-8957	23	4.000	5.125	0.375	102	130	10
25003-8592	23	3.875	4.875	0.438	98	124	11	25003-8976	23	10.375	11.875	0.750	264	302	19
25003-8606	23	8.661	10.236	0.630	220	260	16	25003-8980	23-L	30.000	31.250	0.500	762	794	13
25003-8607	23	9.844	11.417	0.630	250	290	16	25003-8998	23	12.500	13.906	0.750	318	353	19
25003-8614	23	4.625	6.077	0.484	117	154	12	25003-8999	23-L	13.895	15.750	0.750	353	400	19
25003-8618	23-L	66.500	68.500	0.813	1689	1740	21	25003-9015	23	3.469	4.500	0.500	88	114	13
25003-8620	23-L	13.500	15.000	0.625	343	381	16	25003-9017	23	5.750	7.250	0.750	146	184	19
25003-8623	23	8.469	9.968	0.500	215	253	13	25003-9021	23	6.438	7.938	0.750	164	202	19
25003-8624	23-L	23.622	25.197	0.788	600	640	20	25003-9025	23-L	25.750	26.875	0.563	654	683	14
25003-8629	23	4.938	6.000	0.375	125	152	10	25003-9031	23	5.938	7.688	0.625	151	195	16
25003-8634	23-L	19.685	21.685	0.812	500	551	21	25003-9056	23	3.375	4.375	0.375	86	111	10
25003-8639	23	3.688	4.688	0.375	94	119	10	25003-9057	23	9.938	11.500	0.750	252	292	19
25003-8654	23	6.188	7.437	0.625	157	189	16	25003-9060	23	4.125	5.250	0.375	105	133	10
25003-8655	23	10.630	12.205	0.630	270	310	16	25003-9065	23	7.519	9.019	0.750	191	229	19
25003-8656	23-L	13.780	15.354	0.630	350	390	16	25003-9077	23-L	16.000	17.000	0.500	406	432	13
25003-8658	23-L	21.875	23.875	0.813	556	606	21	25003-9085	23	4.438	5.938	0.500	113	151	13
25003-8665	23	8.500	10.000	0.500	216	254	13	25003-9089	23	3.750	5.000	0.375	95	127	10
25003-8684	23-L	36.500	38.250	0.813	927	972	21	25003-9090	23-L	25.500	27.500	0.813	648	699	21
25003-8689	23-L	24.500	26.500	0.813	622	673	21	25003-9094	23	11.500	12.500	0.500	292	318	13
25003-8691	23-L	18.000	19.500	0.813	457	495	21	25003-9099	23	6.062	7.313	0.625	154	186	16
25003-8693	23	3.344	4.344	0.375	85	110	10	25003-9104	23	3.688	4.688	0.500	94	119	13
25003-8695	23-L	18.504	20.472	0.740	470	520	19	25003-9114	23-L	17.000	18.125	0.563	432	460	14
25003-8699	23	6.693	7.943	0.625	170	202	16	25003-9115	23-L	19.000	21.000	0.750	483	533	19
25003-8701	23-L	13.386	14.886	0.750	340	378	19	25003-9116	23-L	14.500	16.500	0.625	368	419	16
25003-8702	23-L	15.748	17.480	0.669	400	444	17	25003-9132	23	4.500	6.000	0.375	114	152	10
25003-8705	23-L	16.535	18.504	0.748	420	470	19	25003-9133	23	10.375	11.625	0.625	264	295	16
25003-8709	23	8.500	9.875	0.750	216	251	19	25003-9142	23	5.875	7.375	0.750	149	187	19
25003-8713	23-L	15.748	17.748	0.750	400	451	19	25003-9143	23	4.313	5.313	0.500	110	135	13
25003-8719	23-L	19.125	21.125	0.813	486	537	21	25003-9144	23	4.330	5.500	0.438	110	140	11
25003-8721	23	1.750	2.656	0.625	44	67	16	25003-9145	23	9.938	11.438	0.750	252	291	19
25003-8741	23-L	14.500	15.500	0.500	368	394	13	25003-9146	23	8.688	9.688	0.500	221	246	13
25003-8748	23-L	68.000	70.000	0.812	1727	1778	21	25003-9148	23	12.000	13.938	0.813	305	354	21
25003-8750	23-L	67.000	69.000	0.813	1702	1753	21	25003-9149	23	11.000	12.875	0.812	279	327	21
25003-8753	23	9.438	10.438	0.500	240	265	13	25003-9151	23	8.938	9.938	0.500	227	252	13
25003-8761	23	11.000	12.000	0.375	279	305	10	25003-9154	23-L	25.000	27.000	0.750	635	686	19
25003-8768	23	4.133	5.118	0.472	105	130	12	25003-9156	23-L	31.750	33.750	0.750	806	857	19
25003-8776	23	8.375	9.625	0.500	213	244	13	25003-9158	23	5.512	6.692	0.500	140	170	13
25003-8780	23-L	17.000	18.250	0.625	432	464	16	25003-9162	23	2.559	3.543	0.375	65	90	10
25003-8783	23	9.500	10.750	0.500	241	273	13	25003-9163	23-L	14.875	16.875	0.500	378	429	13
25003-8790	23	3.938	4.906	0.500	100	125	13	25003-9172	23	9.250	11.250	0.625	235	286	16
25003-8802	23-L	82.677	84.646	0.815	2100	2150	21	25003-9173	23-L	22.938	24.938	0.813	583	633	21
25003-8803	23	3.543	4.527	0.491	90	115	12	25003-9174	23	3.750	4.625	0.375	95	117	10
25003-8805	23	8.063	9.062	0.463	205	230	12	25003-9175	23	5.315	6.693	0.472	135	170	12
25003-8838	23	9.062	10.500	0.750	230	267	19	25003-9181	23-L	15.000	17.000	0.625	381	432	16
25003-8841	23	10.000	11.438	0.750	254	291	19	25003-9182	23-L	14.173	15.748	0.787	360	400	20
25003-8846	23	9.563	11.062	0.625	243	281	16	25003-9184	23	8.000	9.438	0.500	203	240	13
25003-8847	23-L	15.812	17.437	0.812	402	443	21	25003-9185	23	6.438	7.375	0.500	164	187	13
25003-8850	23-L	14.000	15.250	0.750	356	387	19	25003-9188	23-L	43.125	44.625	0.750	1095	1133	19
25003-8861	23-L	15.250	16.625	0.531	387	422	13	25003-9190	23	3.740	4.724	0.472	95	120	12
25003-8865	23-L	74.000	76.000	0.812	1880	1930	21	25003-9197	23	5.813	6.813	0.500	148	173	13
25003-8869	23-L	20.500	21.500	0.500	521	546	13	25003-9200	23-L	39.250	41.250	0.813	997	1048	21
25003-8874	23	10.938	12.500	0.625	278	318	16	25003-9201	23	9.000	10.000	0.438	229	254	11
25003-8888	23-L	14.750	16.125	0.688	375	410	17	25003-9202	23-L	52.250	54.125	0.813	1327	1375	21
25003-8905	23	2.362	3.112	0.375	60	79	10	25003-9203	23	8.625	10.625	0.813	219	270	21
25003-8934	23-L	30.500	32.500	0.813	775	826	21	25003-9204	23	4.375	5.375	0.375	111	137	10

All dimensions are in inches. Preferred sizes are indicated with **bold** type face.

Sizes listed are for standard nitrile elements, except Models 25 and 62 which have PTFE elements. Other material available on inquiry only.

## Oil Seals by Model Number

Product Code	Model	Inches			MM			Product Code	Model	Inches			MM		
		ID	OD	Width	ID	OD	Width			ID	OD	Width	ID	OD	Width
25003-9205	23-L	32.250	34.250	0.813	819	870	21	25003-9371	23-L	23.250	25.250	0.750	591	641	19
25003-9207	23	8.500	9.750	0.750	216	248	19	25003-9372	23	4.969	6.375	0.500	126	162	13
25003-9210	23	8.625	9.875	0.500	219	251	13	25003-9374	23	6.500	7.500	0.438	165	191	11
25003-9212	23-L	32.375	33.625	0.500	822	854	13	25003-9382	23-L	25.625	26.625	0.500	651	676	13
25003-9217	23	6.500	7.875	0.750	165	200	19	25003-9384	23	10.250	11.250	0.625	260	286	16
25003-9219	23-L	36.625	38.625	0.813	930	981	21	25003-9389	23	5.000	6.000	0.438	127	152	11
25003-9230	23	3.000	4.062	0.375	76	103	10	25003-9391	23-L	21.250	23.250	0.813	540	591	21
25003-9232	23	6.125	7.000	0.500	156	178	13	25003-9392	23-L	20.827	22.827	0.812	529	580	21
25003-9236	23-L	60.000	62.000	0.750	1524	1575	19	25003-9394	23-L	55.000	56.500	0.750	1397	1435	19
25003-9238	23-L	42.375	44.375	0.750	1076	1127	19	25003-9395	23-L	53.500	55.000	0.750	1359	1397	19
25003-9242	23	8.661	9.911	0.500	220	252	13	25003-9396	23-L	12.438	14.000	0.750	316	356	19
25003-9243	23	8.661	9.911	0.625	220	252	16	25003-9404	23	6.750	8.250	0.500	171	210	13
25003-9244	23	7.062	8.563	0.500	179	218	13	25003-9420	23-L	27.750	28.875	0.563	705	733	14
25003-9245	23	6.031	7.312	0.500	153	186	13	25003-9421	23-L	17.625	19.625	0.813	448	498	21
25003-9251	23	5.313	6.938	0.500	135	176	13	25003-9427	23-L	55.000	57.000	0.813	1397	1448	21
25003-9253	23	9.688	11.188	0.750	246	284	19	25003-9435	23	9.448	11.024	0.787	240	280	20
25003-9254	23-L	14.750	16.750	0.750	375	425	19	25003-9440	23	5.750	7.202	0.734	146	183	19
25003-9255	23-L	13.000	14.750	0.500	330	375	13	25003-9458	23	6.000	7.452	0.734	152	189	19
25003-9256	23-L	13.375	15.375	0.813	340	391	21	25003-9473	23	8.188	9.687	0.500	208	246	13
25003-9258	23-L	13.125	14.625	0.750	333	371	19	25003-9476	23	10.250	11.250	0.500	260	286	13
25003-9261	23-L	17.500	18.500	0.500	445	470	13	25003-9477	23-L	18.750	20.250	0.813	476	514	21
25003-9262	23	7.063	8.062	0.625	179	205	16	25003-9478	23-L	20.250	21.250	0.500	514	540	13
25003-9266	23-L	25.875	27.875	0.813	657	708	21	25003-9479	23-L	17.716	19.716	0.812	450	501	21
25003-9267	23	8.375	10.375	0.750	213	264	19	25003-9483	23	5.000	6.375	0.750	127	162	19
25003-9268	23	4.984	6.234	0.500	127	158	13	25003-9484	23-L	16.188	18.188	0.813	411	462	21
25003-9269	23-L	93.000	95.000	0.813	2362	2413	21	25003-9487	23	3.922	4.922	0.500	100	125	13
25003-9272	23	9.938	11.188	0.625	252	284	16	25003-9491	23	11.813	13.313	0.750	300	338	19
25003-9273	23-L	17.125	18.125	0.500	435	460	13	25003-9493	23-L	31.500	32.500	0.500	800	826	13
25003-9275	23	5.196	6.299	0.500	132	160	13	25003-9510	23	2.688	3.688	0.375	68	94	10
25003-9276	23-L	20.875	22.875	0.813	530	581	21	25003-9512	23-L	14.100	15.600	0.750	358	396	19
25003-9279	23-L	15.125	16.125	0.375	384	410	10	25003-9529	23-L	16.732	18.701	0.787	425	475	20
25003-9282	23-L	24.500	26.000	0.750	622	660	19	25003-9535	23	10.875	12.875	0.578	276	327	15
25003-9284	23	3.938	4.724	0.500	100	120	13	25003-9536	23	9.500	11.500	0.578	241	292	15
25003-9285	23-L	16.250	18.000	0.813	413	457	21	25003-9539	23	3.313	4.125	0.438	84	105	11
25003-9286	23-L	16.225	17.725	0.750	412	450	19	25003-9541	23	5.125	6.625	0.484	130	168	12
25003-9287	23-L	14.013	15.513	0.750	356	394	19	25003-9544	23	9.375	10.625	0.500	238	270	13
25003-9289	23-L	64.500	66.500	0.813	1638	1689	21	25003-9545	23-L	49.250	50.750	0.750	1251	1289	19
25003-9290	23-L	68.000	70.000	0.750	1727	1778	19	25003-9547	23	3.712	4.712	0.500	94	120	13
25003-9295	23	9.188	10.688	0.750	233	271	19	25003-9548	23	8.375	9.375	0.500	213	238	13
25003-9298	23	3.875	5.000	0.375	98	127	10	25003-9554	23-L	37.500	39.500	0.813	953	1003	21
25003-9300	23	9.625	11.125	0.625	244	283	16	25003-9559	23	8.750	9.875	0.688	222	251	17
25003-9301	23	12.375	13.875	0.625	314	352	16	25003-9567	23	4.331	5.512	0.500	110	140	13
25003-9303	23-L	16.875	18.875	0.813	429	479	21	25003-9569	23-L	25.750	27.750	0.813	654	705	21
25003-9305	23-L	25.750	26.875	0.750	654	683	19	25003-9575	23-L	28.250	30.250	0.813	718	768	21
25003-9313	23-L	24.750	25.750	0.500	629	654	13	25003-9578	23	8.000	8.875	0.438	203	225	11
25003-9315	23-L	17.332	18.832	0.750	440	478	19	25003-9581	23-L	17.750	18.750	0.500	451	476	13
25003-9316	23-L	13.780	15.276	0.748	350	388	19	25003-9591	23-L	14.750	16.750	0.813	375	425	21
25003-9317	23	9.774	11.024	0.500	248	280	13	25003-9594	23	9.625	11.625	0.813	244	295	21
25003-9324	23-L	37.000	39.000	0.813	940	991	21	25003-9595	23-L	15.750	17.250	0.750	400	438	19
25003-9327	23-L	57.375	58.875	0.750	1457	1495	19	25003-9598	23-L	13.000	15.000	0.625	330	381	16
25003-9331	23-L	13.375	14.375	0.500	340	365	13	25003-9599	23-L	63.000	65.000	0.813	1600	1651	21
25003-9335	23-L	35.375	37.375	0.813	899	949	21	25003-9601	23-L	17.500	19.500	0.813	445	495	21
25003-9338	23-L	17.375	18.875	0.750	441	479	19	25003-9602	23-L	39.000	40.000	0.500	991	1016	13
25003-9339	23-L	30.000	31.000	0.500	762	787	13	25003-9614	23	3.375	4.500	0.375	86	114	10
25003-9340	23	7.688	9.188	0.750	195	233	19	25003-9639	23-L	21.260	23.228	0.811	540	590	21
25003-9344	23-L	65.250	67.250	0.813	1657	1708	21	25003-9640	23	4.250	5.703	0.484	108	145	12

All dimensions are in inches. Preferred sizes are indicated with **bold** type face. Sizes listed are for standard nitrile elements, except Models 25 and 62 which have PTFE elements. Other material available on inquiry only.

## Oil Seals by Model Number

Product Code	Model	Inches			MM			Product Code	Model	Inches			MM		
		ID	OD	Width	ID	OD	Width			ID	OD	Width	ID	OD	Width
25003-9644	23-L	19.000	20.204	0.531	483	513	13	25003-9848	23-L	49.000	51.000	0.812	1245	1295	21
25003-9645	23-L	35.500	37.500	0.813	902	953	21	25003-9851	23	4.000	4.938	0.375	102	125	10
25003-9647	23-L	26.750	28.750	0.813	679	730	21	25003-9852	23-L	29.000	30.125	0.500	737	765	13
25003-9648	23	4.000	5.131	0.375	102	130	10	25003-9858	23	7.086	8.586	0.750	180	218	19
25003-9649	23	3.000	4.375	0.375	76	111	10	25003-9859	23-L	20.500	21.500	0.469	521	546	12
25003-9662	23	4.000	5.000	0.438	102	127	11	25003-9861	23	7.813	9.062	0.625	198	230	16
25003-9663	23	5.687	7.187	0.500	144	183	13	25003-9862	23	4.313	5.313	0.375	110	135	10
25003-9672	23	4.450	5.692	0.500	113	145	13	25003-9869	23-L	75.000	77.000	0.813	1905	1956	21
25003-9676	23	9.844	11.020	0.500	250	280	13	25003-9874	23	8.062	9.312	0.625	205	237	16
25003-9679	23	10.500	11.625	0.547	267	295	14	25003-9875	23	9.250	11.250	0.813	235	286	21
25003-9687	23-L	14.125	15.625	0.750	359	397	19	25003-9877	23	4.125	5.250	0.406	105	133	10
25003-9690	23-L	27.875	29.875	0.813	708	759	21	25003-9880	23	5.875	7.125	0.455	149	181	12
25003-9691	23	2.500	3.375	0.375	64	86	10	25003-9881	23-L	18.504	20.000	0.748	470	508	19
25003-9693	23	11.000	12.000	0.500	279	305	13	25003-9888	23	9.563	10.813	0.625	243	275	16
25003-9702	23	5.000	5.875	0.375	127	149	10	25003-9889	23	8.313	9.563	0.625	211	243	16
25003-9704	23	3.167	4.167	0.500	80	106	13	25003-9890	23-L	27.992	29.119	0.500	711	740	13
25003-9721	23	11.750	13.750	0.625	298	349	16	25003-9893	23-L	20.625	22.625	0.813	524	575	21
25003-9732	23-L	14.625	16.125	0.750	371	410	19	25003-9895	23	7.620	9.120	0.750	194	232	19
25003-9734	23-L	19.375	21.375	0.813	492	543	21	25003-9896	23-L	14.938	16.438	0.750	379	418	19
25003-9735	23-L	40.500	41.500	0.500	1029	1054	13	25003-9897	23-L	68.968	70.957	0.787	1752	1802	20
25003-9736	23-L	31.500	33.000	0.750	800	838	19	25003-9899	23-L	52.875	53.875	0.500	1343	1368	13
25003-9741	23	4.000	5.031	0.375	102	128	10	25003-9900	23-L	40.750	42.000	0.750	1035	1067	19
25003-9742	23-L	18.875	20.875	0.813	479	530	21	25003-9902	23-L	108.000	110.000	0.813	2743	2794	21
25003-9744	23-L	20.866	22.866	0.813	530	581	21	25003-9904	23-L	38.500	40.750	0.750	978	1035	19
25003-9749	23	11.875	13.875	0.750	302	352	19	25003-9906	23-L	15.125	17.125	0.750	384	435	19
25003-9752	23-L	16.750	18.750	0.813	425	476	21	25003-9907	23-L	21.500	23.500	0.750	546	597	19
25003-9757	23-L	16.375	18.375	0.813	416	467	21	25003-9908	23-L	44.290	45.790	0.750	1125	1163	19
25003-9759	23-L	26.250	28.250	0.813	667	718	21	25003-9912	23-L	54.000	56.000	0.813	1372	1422	21
25003-9760	23	5.563	6.563	0.500	141	167	13	25003-9913	23-L	40.750	42.000	0.687	1035	1067	17
25003-9761	23	4.321	5.195	0.500	110	132	13	25003-9914	23	5.688	6.938	0.625	144	176	16
25003-9763	23-L	14.000	16.000	0.625	356	406	16	25003-9915	23	3.000	4.000	0.438	76	102	11
25003-9776	23	10.438	11.938	0.750	265	303	19	25003-9916	23	9.438	10.938	0.750	240	278	19
25003-9777	23-L	41.250	43.250	0.750	1048	1099	19	25003-9917	23-L	56.102	58.346	0.750	1425	1482	19
25003-9779	23-L	52.000	54.000	0.750	1321	1372	19	25003-9918	23-L	44.337	45.837	0.750	1126	1164	19
25003-9780	23	6.500	7.500	0.563	165	191	14	25003-9919	23-L	54.331	56.299	0.984	1380	1430	25
25003-9781	23-L	58.000	60.000	0.813	1473	1524	21	25003-9920	23-L	70.000	71.000	0.500	1778	1803	13
25003-9783	23-L	13.937	15.437	0.750	354	392	19	25003-9925	23-L	17.717	19.409	0.787	450	493	20
25003-9785	23	4.375	5.828	0.484	111	148	12	25003-9928	23-L	12.380	14.380	0.813	314	365	21
25003-9789	23	6.299	7.299	0.500	160	185	13	25003-9929	23-L	13.925	15.925	0.812	354	404	21
25003-9791	23	4.937	6.062	0.500	125	154	13	25003-9932	23	10.938	12.188	0.813	278	310	21
25003-9792	23	7.438	8.938	0.750	189	227	19	25003-9938	23-L	51.575	53.575	0.813	1310	1361	21
25003-9797	23-L	28.875	30.875	0.813	733	784	21	25003-9939	23	6.375	7.375	0.375	162	187	10
25003-9800	23-L	68.500	70.500	0.813	1740	1791	21	25003-9940	23-L	18.750	20.750	0.813	476	527	21
25003-9801	23-L	20.063	22.062	0.813	510	560	21	25003-9941	23	9.445	10.633	0.500	240	270	13
25003-9805	23	7.063	8.563	0.750	179	218	19	25003-9942	23	11.335	12.520	0.500	288	318	13
25003-9806	23-L	65.354	67.354	0.813	1660	1711	21	25003-9944	23	3.438	4.938	0.500	87	125	13
25003-9820	23-L	50.000	52.000	0.813	1270	1321	21	25003-9947	23	9.750	11.750	0.625	248	298	16
25003-9823	23	6.438	7.938	0.625	164	202	16	25003-9948	23	9.000	11.000	0.625	229	279	16
25003-9824	23	4.000	5.031	0.500	102	128	13	25003-9949	23-L	13.125	14.875	0.625	333	378	16
25003-9828	23	6.688	8.007	0.625	170	203	16	25003-9953	23-L	88.583	90.583	0.813	2250	2301	21
25003-9829	23	11.250	12.250	0.625	286	311	16	25003-9954	23	3.375	4.375	0.515	86	111	13
25003-9830	23	3.219	4.469	0.500	82	114	13	25003-9955	23	7.938	9.188	0.625	202	233	16
25003-9839	23	4.750	5.938	0.500	121	151	13	25003-9956	23	7.207	8.225	0.500	183	209	13
25003-9842	23	4.563	5.438	0.375	116	138	10	25003-9957	23	10.000	11.500	0.375	254	292	10
25003-9846	23	7.438	8.688	0.625	189	221	16	25003-9958	23	6.670	7.750	0.500	169	197	13
25003-9847	23-L	22.875	24.875	0.813	581	632	21	25003-9960	23	4.250	5.250	0.438	108	133	11

All dimensions are in inches. Preferred sizes are indicated with **bold** type face.

Sizes listed are for standard nitrile elements, except Models 25 and 62 which have PTFE elements. Other material available on inquiry only.

## Oil Seals by Model Number

Product Code	Model	Inches			MM			Product Code	Model	Inches			MM		
		ID	OD	Width	ID	OD	Width			ID	OD	Width	ID	OD	Width
25003-9963	23	3.543	4.528	0.472	90	115	12	25004-2915	23	5.000	6.000	0.500	127	152	13
25003-9968	23-L	32.375	34.375	1.000	822	873	25	25004-2918	23	5.000	6.125	0.500	127	156	13
25003-9969	23	9.844	10.844	0.500	250	275	13	25004-2921	23	5.000	6.250	0.500	127	159	13
25003-9974	23-L	61.250	62.750	0.750	1556	1594	19	25004-2985	23	4.000	5.625	0.375	102	143	10
25003-9976	23	11.750	13.500	0.813	298	343	21	25004-3001	23	5.125	6.500	0.625	130	165	16
25003-9979	23-L	18.750	19.750	0.500	476	502	13	25004-3059	23	5.250	6.250	0.500	133	159	13
25003-9980	23	11.750	13.250	0.625	298	337	16	25004-3065	23	5.250	6.500	0.500	133	165	13
25003-9982	23-L	25.006	26.006	0.375	635	661	10	25004-3067	23	5.250	6.500	0.625	133	165	16
25003-9983	23-L	20.495	21.495	0.375	521	546	10	25004-3071	23	5.250	6.750	0.500	133	171	13
25003-9985	23-L	20.477	21.477	0.375	520	546	10	25004-3125	23	5.375	6.500	0.500	137	165	13
25003-9987	23-L	20.458	21.458	0.375	520	545	10	25004-3176	23	5.500	6.500	0.500	140	165	13
25003-9988	23-L	25.500	26.500	0.500	648	673	13	25004-3184	23	5.500	6.750	0.625	140	171	16
25003-9993	23-L	14.566	16.181	0.629	370	411	16	25004-3213	23-L	49.375	52.375	0.750	1254	1330	19
25003-9994	23	7.087	8.661	0.625	180	220	16	25004-3228	23	5.625	6.625	0.500	143	168	13
25003-9995	23	9.868	11.368	0.750	251	289	19	25004-3239	23	11.750	13.000	0.813	298	330	21
25003-9996	23-L	12.992	14.566	0.708	330	370	18	25004-3254	23-L	24.000	25.000	0.500	610	635	13
25003-9997	23	10.375	12.250	0.750	264	311	19	25004-3269	23	6.299	7.274	0.750	160	185	19
25004-0625	23	10.219	11.219	0.500	260	285	13	25004-3316	23	5.875	6.875	0.500	149	175	13
25004-1020	23	4.477	6.256	0.625	114	159	16	25004-3355	23	6.000	7.000	0.500	152	178	13
25004-1161	23	2.438	3.563	0.625	62	91	16	25004-3430	23	6.500	7.750	0.625	165	197	16
25004-1163	23	2.625	3.750	0.625	67	95	16	25004-3434	23	6.500	8.000	0.625	165	203	16
25004-1206	23	2.000	3.000	0.500	51	76	13	25004-3440	23	6.625	7.875	0.625	168	200	16
25004-1237	23-L	18.110	20.078	0.787	460	510	20	25004-3496	23	7.000	8.250	0.625	178	210	16
25004-1493	23	2.250	3.250	0.438	57	83	11	25004-3501	23	7.000	8.500	0.750	178	216	19
25004-1642	23	2.375	3.125	0.375	60	79	10	25004-3523	23	7.250	8.500	0.750	184	216	19
25004-1668	23	2.375	3.500	0.500	60	89	13	25004-3537	23	7.375	8.875	0.750	187	225	19
25004-1807	23	2.500	3.250	0.375	64	83	10	25004-3553	23	7.500	9.000	0.750	191	229	19
25004-1820	23	2.500	3.500	0.438	64	89	11	25004-3564	23	7.625	9.000	0.625	194	229	16
25004-1821	23	2.500	3.500	0.500	64	89	13	25004-3566	23	7.625	9.125	0.625	194	232	16
25004-1827	23	2.500	3.625	0.500	64	92	13	25004-3574	23	7.750	9.000	0.625	197	229	16
25004-1875	23	3.938	4.921	0.492	100	125	12	25004-3596	23	8.000	9.250	0.625	203	235	16
25004-1894	23	2.563	3.751	0.375	65	95	10	25004-3606	23	8.250	9.500	0.625	210	241	16
25004-1928	23	4.062	5.000	0.375	103	127	10	25004-3662	23	10.000	11.250	0.563	254	286	14
25004-1998	23	3.150	4.331	0.500	80	110	13	25004-3686	23	10.750	12.500	0.563	273	318	14
25004-2049	23	2.750	3.875	0.625	70	98	16	25004-3692	23	11.000	12.250	0.625	279	311	16
25004-2118	23	2.875	3.750	0.375	73	95	10	25004-3845	23-L	18.250	19.938	0.750	464	506	19
25004-2168	23	3.000	3.751	0.375	76	95	10	25004-3885	23	1.750	3.189	0.500	44	81	13
25004-2276	23	3.250	4.500	0.500	83	114	13	25004-3938	23	8.500	10.500	0.813	216	267	21
25004-2290	23	3.239	4.245	0.500	82	108	13	25004-4020	23	10.625	12.375	0.750	270	314	19
25004-2292	23	2.431	3.447	0.500	62	88	13	25004-4032	23	10.875	12.375	0.750	276	314	19
25004-2324	23	3.375	4.500	0.500	86	114	13	25004-4036	23	11.000	13.000	0.813	279	330	21
25004-2348	23	3.438	4.625	0.500	87	117	13	25004-4058	23	11.500	13.000	0.750	292	330	19
25004-2441	23	3.688	4.750	0.500	94	121	13	25004-4063	23	11.500	13.500	0.813	292	343	21
25004-2462	23	3.750	4.750	0.500	95	121	13	25004-4074	23	12.250	13.750	0.750	311	349	19
25004-2501	23	3.875	4.875	0.500	98	124	13	25004-4080	23-L	12.500	14.000	0.750	318	356	19
25004-2519	23	3.938	5.000	0.500	100	127	13	25004-4082	23-L	12.500	14.500	0.750	318	368	19
25004-2537	23	4.000	4.999	0.500	102	127	13	25004-4093	23-L	13.000	14.500	0.688	330	368	17
25004-2543	23	4.000	5.250	0.500	102	133	13	25004-4094	23-L	13.000	14.500	0.750	330	368	19
25004-2600	23	4.125	5.125	0.500	105	130	13	25004-4102	23-L	13.250	14.750	0.750	337	375	19
25004-2606	23	4.125	5.375	0.500	105	137	13	25004-4132	23-L	14.000	15.500	0.750	356	394	19
25004-2657	23	4.250	5.250	0.500	108	133	13	25004-4190	23-L	17.000	19.000	0.813	432	483	21
25004-2669	23	4.250	5.750	0.500	108	146	13	25004-4211	23-L	18.250	19.750	0.750	464	502	19
25004-2783	23	4.563	5.874	0.500	116	149	13	25004-4212	23-L	18.250	19.875	0.750	464	505	19
25004-2798	23	4.625	5.625	0.500	117	143	13	25004-4218	23-L	19.000	20.500	0.750	483	521	19
25004-2870	23	4.875	5.875	0.500	124	149	13	25004-4503	23	9.000	10.000	0.625	229	254	16
25004-2911	23-L	12.598	14.330	0.787	320	364	20	25004-4505	23	9.000	10.250	0.625	229	260	16

All dimensions are in inches. Preferred sizes are indicated with **bold** type face. Sizes listed are for standard nitrile elements, except Models 25 and 62 which have PTFE elements. Other material available on inquiry only.

## Oil Seals by Model Number

Product Code	Model	Inches			MM			Product Code	Model	Inches			MM		
		ID	OD	Width	ID	OD	Width			ID	OD	Width	ID	OD	Width
25004-4509	23	9.250	10.250	0.625	235	260	16	25004-6844	23	7.875	9.000	0.500	200	229	13
25004-4511	23	9.250	10.500	0.625	235	267	16	25004-6870	23	4.125	5.000	0.500	105	127	13
25004-4557	23	3.000	4.000	0.500	76	102	13	25004-6877	23-L	14.000	16.000	0.750	356	406	19
25004-4560	23	6.500	7.500	0.500	165	191	13	25004-7075	23	3.438	4.438	0.375	87	113	10
25004-4602	23	11.811	13.543	0.787	300	344	20	25004-7268	23	6.693	7.875	0.591	170	200	15
25004-4603	23-L	13.779	15.512	0.787	350	394	20	25004-7306	23	12.000	13.250	0.625	305	337	16
25004-4629	23-L	15.748	17.480	0.787	400	444	20	25004-7322	23	9.062	10.062	0.500	230	256	13
25004-4630	23-L	12.992	14.724	0.787	330	374	20	25004-7374	23	3.250	4.250	0.500	83	108	13
25004-4651	23	4.000	5.000	0.500	102	127	13	25004-7407	23-L	21.500	23.500	0.813	546	597	21
25004-4750	23	5.437	6.437	0.500	138	163	13	25004-7656	23	3.188	4.188	0.375	81	106	10
25004-4760	23	8.250	9.375	0.500	210	238	13	25004-7661	23	7.938	8.938	0.500	202	227	13
25004-4765	23	2.755	3.543	0.375	70	90	10	25004-7847	23	7.438	8.438	0.500	189	214	13
25004-4805	23	10.236	11.968	0.787	260	304	20	25004-7891	23	9.449	11.024	0.630	240	280	16
25004-4822	23	8.000	9.000	0.438	203	229	11	25004-8233	23	3.250	4.249	0.375	83	108	10
25004-4923	23	10.000	11.250	0.500	254	286	13	25004-8276	23	2.344	3.219	0.625	60	82	16
25004-4924	23	7.000	8.250	0.500	178	210	13	25004-8315	23	11.750	13.750	0.813	298	349	21
25004-5023	23	3.000	4.000	0.375	76	102	10	25004-8334	23	10.500	11.750	0.500	267	298	13
25004-5079	23	3.750	5.000	0.500	95	127	13	25004-8433	23	6.875	7.875	0.500	175	200	13
25004-5092	23	5.313	6.563	0.625	135	167	16	25004-8451	23	8.250	9.500	0.500	210	241	13
25004-5168	23-L	17.000	19.000	0.750	432	483	19	25004-8560	23	8.500	10.500	0.500	216	267	13
25004-5189	23	5.125	6.125	0.375	130	156	10	25004-8578	23	7.813	8.813	0.500	198	224	13
25004-5190	23	4.188	5.688	0.375	106	144	10	25004-8607	23	9.842	11.417	0.629	250	290	16
25004-5259	23-L	21.000	22.500	0.750	533	572	19	25004-8665	23	8.500	10.000	0.500	216	254	13
25004-5337	23	7.875	9.055	0.492	200	230	12	25004-8783	23	9.500	10.750	0.500	241	273	13
25004-5339	23	9.842	11.023	0.590	250	280	15	25004-9143	23	4.313	5.313	0.500	110	135	13
25004-5575	23	9.062	10.062	0.375	230	256	10	25004-9162	23	2.559	3.543	0.375	65	90	10
25004-5667	23-L	12.598	14.095	0.750	320	358	19	25004-9197	23	5.813	6.813	0.500	148	173	13
25004-5696	23	5.250	6.437	0.500	133	163	13	25004-9204	23	4.375	5.375	0.375	111	137	10
25004-5934	23	10.500	11.750	0.625	267	298	16	25004-9207	23	8.500	9.750	0.750	216	248	19
25004-5952	23	9.000	10.500	0.500	229	267	13	25004-9260	23	9.625	11.125	0.750	244	283	19
25004-6142	23	4.125	5.500	0.438	105	140	11	25004-9272	23	9.938	11.188	0.625	252	284	16
25004-6264	23-L	13.250	15.250	0.750	337	387	19	25004-9298	23	3.875	5.000	0.375	98	127	10
25004-6285	23	3.500	4.375	0.500	89	111	13	25004-9476	23	10.250	11.250	0.500	260	286	13
25004-6351	23	2.938	3.938	0.500	75	100	13	25004-9646	23	3.938	5.062	0.375	100	129	10
25004-6356	23	3.250	4.250	0.375	83	108	10	25004-9734	23-L	19.375	21.375	0.813	492	543	21
25004-6358	23	3.500	4.500	0.375	89	114	10	25004-9851	23	4.000	4.938	0.375	102	125	10
25004-6360	23	4.000	5.000	0.375	102	127	10	25004-9861	23	7.813	9.062	0.625	198	230	16
25004-6363	23	4.500	5.500	0.375	114	140	10	25004-9980	23	11.750	13.250	0.625	298	337	16
25004-6364	23	4.687	5.812	0.500	119	148	13	25006-0614	23-L	14.961	16.535	0.787	380	420	20
25004-6365	23	5.000	6.000	0.375	127	152	10	25006-0681	23-L	12.000	14.000	0.770	305	356	20
25004-6372	23	6.750	7.750	0.500	171	197	13	25006-0686	23	10.000	12.000	0.703	254	305	18
25004-6374	23	7.000	8.000	0.500	178	203	13	25006-0710	23	2.559	3.346	0.375	65	85	10
25004-6376	23	7.250	8.250	0.500	184	210	13	25006-0816	23	9.313	11.125	0.688	237	283	17
25004-6378	23	7.500	8.500	0.500	191	216	13	25006-0963	23-L	14.173	15.591	0.630	360	396	16
25004-6379	23	7.750	8.750	0.500	197	222	13	25006-0968	23-L	16.310	17.750	0.688	414	451	17
25004-6382	23	8.250	9.250	0.500	210	235	13	25006-0994	23-L	13.070	14.570	0.750	332	370	19
25004-6383	23	8.500	9.500	0.500	216	241	13	25006-1013	23-L	15.375	17.125	0.813	391	435	21
25004-6387	23	9.000	10.000	0.500	229	254	13	25006-1016	23-L	12.813	14.813	0.750	325	376	19
25004-6388	23	9.500	10.500	0.500	241	267	13	25006-1033	23	3.150	3.938	0.394	80	100	10
25004-6391	23	10.000	11.000	0.500	254	279	13	25006-1036	23	9.449	10.827	0.709	240	275	18
25004-6508	23-L	19.000	21.000	0.813	483	533	21	25006-1204	23	2.000	3.000	0.375	51	76	10
25004-6568	23	10.441	11.441	0.375	265	291	10	25006-1206	23	2.000	3.000	0.500	51	76	13
25004-6719	23	11.906	13.156	0.625	302	334	16	25006-1208	23	7.874	9.252	0.630	200	235	16
25004-6808	23	10.000	11.250	0.625	254	286	16	25006-1214	23	7.480	9.055	0.630	190	230	16
25004-6827	23	8.750	9.750	0.500	222	248	13	25006-1220	23	8.938	10.438	0.750	227	265	19
25004-6839	23	3.250	4.250	0.438	83	108	11	25006-1222	23	9.056	10.433	0.709	230	265	18

All dimensions are in inches. Preferred sizes are indicated with **bold** type face.

Sizes listed are for standard nitrile elements, except Models 25 and 62 which have PTFE elements. Other material available on inquiry only.

## Oil Seals by Model Number

Product Code	Model	Inches			MM			Product Code	Model	Inches			MM		
		ID	OD	Width	ID	OD	Width			ID	OD	Width	ID	OD	Width
25006-1290	23	7.480	8.425	0.472	190	214	12	25006-2866	23	7.480	8.677	0.500	190	220	13
25006-1293	23-L	15.375	16.250	0.437	391	413	11	25006-2870	23	4.875	5.875	0.500	124	149	13
25006-1314	23	9.842	11.842	0.750	250	301	19	25006-2894	23	4.938	6.000	0.500	125	152	13
25006-1316	23	7.480	8.980	0.750	190	228	19	25006-2900	23	4.938	6.250	0.500	125	159	13
25006-1392	23	8.661	10.236	0.787	220	260	20	25006-2911	23-L	12.598	14.330	0.787	320	364	20
25006-1440	23	3.437	4.500	0.437	87	114	11	25006-2915	23	5.000	6.000	0.500	127	152	13
25006-1515	23	3.625	4.609	0.492	92	117	12	25006-2921	23	5.000	6.250	0.500	127	159	13
25006-1590	23	3.228	4.488	0.500	82	114	13	25006-2928	23	5.000	6.500	0.563	127	165	14
25006-1657	23	2.375	3.350	0.375	60	85	10	25006-2929	23	5.000	6.500	0.625	127	165	16
25006-1682	23	5.500	6.375	0.500	140	162	13	25006-2956	23-L	29.134	31.102	0.812	740	790	21
25006-1718	23	5.512	6.693	0.472	140	170	12	25006-2990	23	5.125	6.125	0.500	130	156	13
25006-1820	23	2.500	3.500	0.437	64	89	11	25006-3012	23	4.310	5.348	0.375	109	136	10
25006-1821	23	2.500	3.500	0.500	64	89	13	25006-3059	23	5.250	6.250	0.500	133	159	13
25006-1844	23	2.625	3.625	0.500	67	92	13	25006-3065	23	5.250	6.500	0.500	133	165	13
25006-1885	23	2.563	3.500	0.375	65	89	10	25006-3096	23	3.820	5.042	0.375	97	128	10
25006-1911	23-L	20.866	22.835	0.787	530	580	20	25006-3131	23	5.375	6.750	0.500	137	171	13
25006-2035	23	2.750	3.500	0.375	70	89	10	25006-3148	23	5.512	7.087	0.625	140	180	16
25006-2044	23	2.750	3.751	0.375	70	95	10	25006-3176	23	5.500	6.500	0.500	140	165	13
25006-2069	23-L	15.748	17.717	0.788	400	450	20	25006-3182	23	5.500	6.750	0.500	140	171	13
25006-2104	23	10.985	12.993	0.748	279	330	19	25006-3209	23-L	12.795	14.370	0.630	325	365	16
25006-2118	23	2.875	3.750	0.375	73	95	10	25006-3228	23	5.625	6.625	0.500	143	168	13
25006-2167	23	2.938	4.000	0.500	75	102	13	25006-3236	23	5.625	6.875	0.625	143	175	16
25006-2168	23	3.000	3.751	0.375	76	95	10	25006-3260	23	6.250	7.875	0.625	159	200	16
25006-2176	23	3.000	4.003	0.500	76	102	13	25006-3275	23	5.750	6.750	0.500	146	171	13
25006-2181	23-L	54.331	56.693	0.812	1380	1440	21	25006-3281	23	5.750	7.000	0.500	146	178	13
25006-2214	23	3.346	4.331	0.472	85	110	12	25006-3282	23	5.750	7.000	0.563	146	178	14
25006-2225	23	3.125	4.125	0.500	79	105	13	25006-3283	23	5.750	7.000	0.625	146	178	16
25006-2245	23-L	13.386	15.118	0.787	340	384	20	25006-3316	23	5.875	6.875	0.500	149	175	13
25006-2297	23	3.313	4.375	0.500	84	111	13	25006-3319	23	5.875	7.000	0.500	149	178	13
25006-2324	23	3.375	4.500	0.500	86	114	13	25006-3327	23	5.906	7.087	0.591	150	180	15
25006-2348	23	3.438	4.625	0.500	87	117	13	25006-3331	23	5.875	7.500	0.500	149	191	13
25006-2364	23	3.500	4.375	0.375	89	111	10	25006-3335	23	5.938	7.000	0.500	151	178	13
25006-2366	23	3.500	4.500	0.500	89	114	13	25006-3355	23	6.000	7.000	0.500	152	178	13
25006-2372	23	3.500	4.750	0.500	89	121	13	25006-3361	23	6.000	7.250	0.500	152	184	13
25006-2441	23	3.688	4.750	0.500	94	121	13	25006-3363	23	6.000	7.250	0.625	152	184	16
25006-2462	23	3.750	4.750	0.500	95	121	13	25006-3364	23	6.000	7.375	0.500	152	187	13
25006-2501	23	3.875	4.875	0.500	98	124	13	25006-3367	23	6.000	7.500	0.500	152	191	13
25006-2537	23	4.000	4.999	0.500	102	127	13	25006-3369	23	6.000	7.500	0.625	152	191	16
25006-2540	23	4.000	5.125	0.500	102	130	13	25006-3375	23	6.125	7.125	0.500	156	181	13
25006-2543	23	4.000	5.250	0.500	102	133	13	25006-3388	23	6.250	7.250	0.500	159	184	13
25006-2603	23	4.125	5.250	0.500	105	133	13	25006-3394	23	6.250	7.500	0.500	159	191	13
25006-2609	23	4.125	5.500	0.500	105	140	13	25006-3396	23	6.250	7.500	0.625	159	191	16
25006-2657	23	4.250	5.250	0.500	108	133	13	25006-3406	23	6.375	7.375	0.500	162	187	13
25006-2663	23	4.250	5.500	0.500	108	140	13	25006-3415	23	6.375	7.625	0.625	162	194	16
25006-2738	23	4.437	5.750	0.500	113	146	13	25006-3426	23	6.500	7.500	0.625	165	191	16
25006-2753	23	4.500	5.500	0.500	114	140	13	25006-3428	23	6.500	7.625	0.625	165	194	16
25006-2759	23	4.500	5.750	0.500	114	146	13	25006-3435	23	6.500	8.000	0.750	165	203	19
25006-2763	23	4.500	5.750	0.375	114	146	10	25006-3444	23	6.625	8.125	0.625	168	206	16
25006-2790	23	4.494	5.925	0.500	114	150	13	25006-3456	23	6.750	7.750	0.625	171	197	16
25006-2798	23	4.625	5.625	0.500	117	143	13	25006-3460	23	6.750	8.000	0.625	171	203	16
25006-2801	23	4.625	5.750	0.500	117	146	13	25006-3464	23	6.750	8.250	0.625	171	210	16
25006-2826	23	6.693	7.874	0.472	170	200	12	25006-3480	23	6.875	8.250	0.625	175	210	16
25006-2828	23	7.087	8.268	0.472	180	210	12	25006-3492	23	7.000	8.000	0.625	178	203	16
25006-2829	23	8.661	9.843	0.472	220	250	12	25006-3496	23	7.000	8.250	0.625	178	210	16
25006-2833	23	8.268	9.449	0.472	210	240	12	25006-3497	23	7.000	8.250	0.750	178	210	19
25006-2843	23	4.750	6.000	0.500	121	152	13	25006-3500	23	7.000	8.500	0.625	178	216	16

All dimensions are in inches. Preferred sizes are indicated with **bold** type face. Sizes listed are for standard nitrile elements, except Models 25 and 62 which have PTFE elements. Other material available on inquiry only.

## Oil Seals by Model Number

Product Code	Model	Inches			MM			Product Code	Model	Inches			MM		
		ID	OD	Width	ID	OD	Width			ID	OD	Width	ID	OD	Width
25006-3501	23	7.000	8.500	0.750	178	216	19	25006-4163	23-L	15.500	17.500	0.813	394	445	21
25006-3518	23	7.250	8.250	0.625	184	210	16	25006-4178	23-L	16.000	17.500	0.750	406	445	19
25006-3522	23	7.250	8.500	0.625	184	216	16	25006-4180	23-L	16.000	18.000	0.813	406	457	21
25006-3526	23	7.250	8.750	0.625	184	222	16	25006-4181	23-L	16.250	17.750	0.688	413	451	17
25006-3532	23	7.375	8.625	0.625	187	219	16	25006-4186	23-L	16.500	18.500	0.813	419	470	21
25006-3537	23	7.375	8.875	0.750	187	225	19	25006-4189	23-L	17.000	18.500	0.750	432	470	19
25006-3544	23	7.500	8.500	0.625	191	216	16	25006-4190	23-L	17.000	19.000	0.813	432	483	21
25006-3548	23	7.500	8.750	0.625	191	222	16	25006-4230	23-L	20.000	21.750	0.813	508	552	21
25006-3552	23	7.500	9.000	0.625	191	229	16	25006-4269	23-L	22.000	23.500	0.750	559	597	19
25006-3553	23	7.500	9.000	0.750	191	229	19	25006-4283	23-L	23.000	24.500	0.750	584	622	19
25006-3564	23	7.625	9.000	0.625	194	229	16	25006-4308	23-L	25.000	26.500	0.750	635	673	19
25006-3566	23	7.625	9.125	0.625	194	232	16	25006-4415	23	5.709	7.087	0.591	145	180	15
25006-3588	23	7.875	9.375	0.625	200	238	16	25006-4433	23	11.417	12.992	0.630	290	330	16
25006-3596	23	8.000	9.250	0.625	203	235	16	25006-4452	23	11.938	13.760	0.750	303	350	19
25006-3600	23	8.000	9.500	0.625	203	241	16	25006-4504	23	9.000	10.125	0.625	229	257	16
25006-3601	23	8.000	9.500	0.750	203	241	19	25006-4505	23	9.000	10.250	0.625	229	260	16
25006-3604	23	8.250	9.250	0.625	210	235	16	25006-4512	23	9.625	10.875	0.750	244	276	19
25006-3606	23	8.250	9.500	0.625	210	241	16	25006-4520	23	10.750	12.000	0.625	273	305	16
25006-3619	23	9.000	10.500	0.750	229	267	19	25006-4530	23-L	13.750	15.250	0.750	349	387	19
25006-3623	23	9.000	11.000	0.750	229	279	19	25006-4557	23	3.000	4.000	0.500	76	102	13
25006-3640	23	9.500	10.750	0.625	241	273	16	25006-4560	23	6.500	7.500	0.500	165	191	13
25006-3692	23	11.000	12.250	0.625	279	311	16	25006-4602	23	11.811	13.543	0.787	300	344	20
25006-3796	23-L	30.000	32.000	1.000	762	813	25	25006-4615	23-L	15.250	16.750	0.688	387	425	17
25006-3813	23-L	32.500	34.500	1.000	826	876	25	25006-4620	23-L	15.749	17.323	0.787	400	440	20
25006-3853	23-L	12.000	14.000	0.625	305	356	16	25006-4627	23-L	34.000	36.500	0.812	864	927	21
25006-3911	23	7.481	8.859	0.630	190	225	16	25006-4629	23-L	15.748	17.480	0.787	400	444	20
25006-3937	23	8.500	10.000	0.750	216	254	19	25006-4636	23-L	36.500	39.000	0.812	927	991	21
25006-3949	23	8.750	10.500	0.750	222	267	19	25006-4651	23	4.000	5.000	0.500	102	127	13
25006-3951	23	8.750	10.750	0.750	222	273	19	25006-4655	23	11.811	13.386	0.787	300	340	20
25006-3955	23	9.000	11.000	0.813	229	279	21	25006-4664	23-L	15.875	17.375	0.750	403	441	19
25006-3979	23	9.500	11.000	0.750	241	279	19	25006-4707	23	12.000	13.500	0.625	305	343	16
25006-3988	23	9.688	11.125	0.750	246	283	19	25006-4750	23	5.438	6.438	0.500	138	164	13
25006-3995	23	10.000	12.000	0.625	254	305	16	25006-4796	23	4.563	5.688	0.500	116	144	13
25006-3996	23	10.000	12.000	0.750	254	305	19	25006-4805	23	10.236	11.968	0.787	260	304	20
25006-4007	23	10.250	12.000	0.750	260	305	19	25006-4817	23	3.938	4.938	0.500	100	125	13
25006-4012	23	10.500	12.000	0.750	267	305	19	25006-4820	23	4.438	5.563	0.500	113	141	13
25006-4024	23	10.750	12.250	0.750	273	311	19	25006-4822	23	8.000	9.000	0.438	203	229	11
25006-4031	23	10.750	12.750	0.813	273	324	21	25006-4885	23	9.055	10.630	0.630	230	270	16
25006-4046	23	11.250	12.750	0.750	286	324	19	25006-4923	23	10.000	11.250	0.500	254	286	13
25006-4058	23	11.500	13.000	0.750	292	330	19	25006-4924	23	7.000	8.250	0.500	178	210	13
25006-4065	23	11.750	13.250	0.750	298	337	19	25006-4950	23	10.000	11.500	0.625	254	292	16
25006-4067	23	12.000	13.500	0.750	305	343	19	25006-5023	23	3.000	4.000	0.375	76	102	10
25006-4071	23-L	12.000	14.000	0.750	305	356	19	25006-5025	23	3.125	4.250	0.500	79	108	13
25006-4072	23-L	12.000	14.000	0.813	305	356	21	25006-5092	23	5.313	6.563	0.625	135	167	16
25006-4080	23-L	12.500	14.000	0.750	318	356	19	25006-5099	23-L	18.938	20.938	0.813	481	532	21
25006-4093	23-L	13.000	14.500	0.688	330	368	17	25006-5100	23	3.542	4.542	0.375	90	115	10
25006-4094	23-L	13.000	14.500	0.750	330	368	19	25006-5118	23	4.724	5.906	0.500	120	150	13
25006-4122	23-L	13.500	15.000	0.750	343	381	19	25006-5166	23	4.875	5.875	0.375	124	149	10
25006-4128	23-L	13.500	15.500	0.813	343	394	21	25006-5168	23-L	17.000	19.000	0.750	432	483	19
25006-4132	23-L	14.000	15.500	0.750	356	394	19	25006-5189	23	5.125	6.125	0.375	130	156	10
25006-4135	23-L	14.000	16.000	0.813	356	406	21	25006-5190	23	4.188	5.688	0.375	106	144	10
25006-4140	23-L	14.250	16.250	0.813	362	413	21	25006-5209	23	3.125	4.000	0.500	79	102	13
25006-4143	23-L	14.500	16.000	0.750	368	406	19	25006-5259	23-L	21.000	22.500	0.750	533	572	19
25006-4148	23-L	14.750	16.250	0.750	375	413	19	25006-5290	23-L	15.354	16.929	0.750	390	430	19
25006-4152	23-L	15.000	16.500	0.750	381	419	19	25006-5334	23	9.055	10.236	0.591	230	260	15
25006-4156	23-L	15.000	17.000	0.813	381	432	21	25006-5339	23	9.843	11.024	0.591	250	280	15

All dimensions are in inches. Preferred sizes are indicated with **bold** type face.

Sizes listed are for standard nitrile elements, except Models 25 and 62 which have PTFE elements. Other material available on inquiry only.

## Oil Seals by Model Number

Product Code	Model	Inches			MM			Product Code	Model	Inches			MM		
		ID	OD	Width	ID	OD	Width			ID	OD	Width	ID	OD	Width
25006-5348	23	4.724	5.906	0.551	120	150	14	25006-6424	23-L	70.000	72.000	0.812	1778	1829	21
25006-5349	23	5.708	6.889	0.551	145	175	14	25006-6464	23	3.813	4.813	0.500	97	122	13
25006-5357	23	8.661	9.842	0.590	220	250	15	25006-6483	23-L	26.000	28.000	0.812	660	711	21
25006-5359	23	9.448	10.629	0.590	240	270	15	25006-6492	23	7.875	8.875	0.500	200	225	13
25006-5367	23	5.118	6.259	0.472	130	159	12	25006-6508	23-L	19.000	21.000	0.813	483	533	21
25006-5395	23	11.125	12.500	0.750	283	318	19	25006-6525	23	4.688	5.688	0.500	119	144	13
25006-5459	23	4.922	5.922	0.500	125	150	13	25006-6560	23-L	14.000	15.000	0.500	356	381	13
25006-5490	23	5.115	6.115	0.500	130	155	13	25006-6561	23	4.938	5.938	0.500	125	151	13
25006-5495	23	4.750	5.625	0.625	121	143	16	25006-6574	23	5.500	6.750	0.750	140	171	19
25006-5597	23	5.875	7.140	0.563	149	181	14	25006-6625	23	4.125	5.125	0.375	105	130	10
25006-5798	23-L	25.000	26.000	0.500	635	660	13	25006-6664	23	9.625	10.875	0.500	244	276	13
25006-5818	23-L	24.500	25.500	0.500	622	648	13	25006-6773	23	7.500	9.000	0.500	191	229	13
25006-5850	23-L	16.929	18.429	0.750	430	468	19	25006-6781	23	10.500	11.500	0.500	267	292	13
25006-5906	23	10.000	12.000	0.688	254	305	17	25006-6827	23	8.750	9.750	0.500	222	248	13
25006-5913	23	3.938	5.000	0.500	100	127	13	25006-6878	23-L	16.125	18.125	0.750	410	460	19
25006-5916	23	8.500	10.500	0.625	216	267	16	25006-6897	23	6.625	7.625	0.500	168	194	13
25006-5919	23-L	24.000	26.000	0.813	610	660	21	25006-6910	23-L	23.250	25.250	0.813	591	641	21
25006-5934	23	10.500	11.750	0.625	267	298	16	25006-7010	23	10.236	11.811	0.630	260	300	16
25006-5952	23	9.000	10.500	0.500	229	267	13	25006-7132	23	5.313	6.313	0.500	135	160	13
25006-6015	23	4.500	5.375	0.500	114	137	13	25006-7175	23-L	13.750	14.750	0.500	349	375	13
25006-6067	23	9.750	10.750	0.500	248	273	13	25006-7200	23-L	24.750	26.750	0.813	629	679	21
25006-6142	23	4.125	5.500	0.438	105	140	11	25006-7205	23	4.500	5.625	0.375	114	143	10
25006-6172	23	6.625	8.125	0.688	168	206	17	25006-7239	23-L	15.375	16.875	0.750	391	429	19
25006-6213	23	4.750	5.750	0.375	121	146	10	25006-7267	23	5.512	6.693	0.591	140	170	15
25006-6237	23-L	39.000	41.000	0.812	991	1041	21	25006-7276	23	6.299	7.480	0.591	160	190	15
25006-6264	23-L	13.250	15.250	0.750	337	387	19	25006-7298	23	5.938	6.938	0.500	151	176	13
25006-6285	23	3.500	4.375	0.500	89	111	13	25006-7306	23	12.000	13.250	0.625	305	337	16
25006-6297	23-L	30.375	32.375	0.812	772	822	21	25006-7321	23	6.438	7.438	0.500	164	189	13
25006-6337	23-L	23.625	25.625	0.812	600	651	21	25006-7331	23-L	29.000	31.000	0.813	737	787	21
25006-6356	23	3.250	4.250	0.375	83	108	10	25006-7367	23	7.625	8.625	0.500	194	219	13
25006-6358	23	3.500	4.500	0.375	89	114	10	25006-7374	23	3.250	4.250	0.500	83	108	13
25006-6360	23	4.000	5.000	0.375	102	127	10	25006-7389	23	3.750	4.750	0.375	95	121	10
25006-6363	23	4.500	5.500	0.375	114	140	10	25006-7391	23	11.024	12.598	0.787	280	320	20
25006-6365	23	5.000	6.000	0.375	127	152	10	25006-7396	23	4.331	5.512	0.472	110	140	12
25006-6367	23	5.438	6.688	0.625	138	170	16	25006-7443	23	7.438	8.500	0.625	189	216	16
25006-6370	23	6.500	8.000	0.500	165	203	13	25006-7547	23-L	13.000	14.750	0.750	330	375	19
25006-6372	23	6.750	7.750	0.500	171	197	13	25006-7548	23-L	38.000	39.500	0.750	965	1003	19
25006-6373	23	6.938	7.938	0.500	176	202	13	25006-7590	23	4.250	5.250	0.375	108	133	10
25006-6374	23	7.000	8.000	0.500	178	203	13	25006-7647	23	5.938	7.187	0.500	151	183	13
25006-6375	23	7.000	8.500	0.500	178	216	13	25006-7656	23	3.188	4.188	0.375	81	106	10
25006-6376	23	7.250	8.250	0.500	184	210	13	25006-7789	23	6.188	7.188	0.500	157	183	13
25006-6378	23	7.500	8.500	0.500	191	216	13	25006-7801	23-L	15.250	16.750	0.750	387	425	19
25006-6379	23	7.750	8.750	0.500	197	222	13	25006-7805	23-L	13.000	14.500	0.625	330	368	16
25006-6380	23	8.000	9.000	0.500	203	229	13	25006-7807	23	7.086	8.267	0.591	180	210	15
25006-6382	23	8.250	9.250	0.500	210	235	13	25006-7816	23	6.299	7.480	0.511	160	190	13
25006-6383	23	8.500	9.500	0.500	216	241	13	25006-7833	23	2.938	3.688	0.375	75	94	10
25006-6384	23	8.500	9.750	0.625	216	248	16	25006-7847	23	7.438	8.438	0.500	189	214	13
25006-6386	23	8.750	10.000	0.625	222	254	16	25006-7863	23-L	38.000	40.000	0.812	965	1016	21
25006-6388	23	9.500	10.500	0.500	241	267	13	25006-7891	23	9.449	11.023	0.630	240	280	16
25006-6389	23	9.625	11.625	0.750	244	295	19	25006-8123	23-L	15.000	16.750	0.813	381	425	21
25006-6391	23	10.000	11.000	0.500	254	279	13	25006-8139	23-L	24.250	25.250	0.500	616	641	13
25006-6396	23-L	12.750	14.750	0.750	324	375	19	25006-8175	23	8.125	9.125	0.500	206	232	13
25006-6399	23-L	18.000	20.000	0.813	457	508	21	25006-8229	23	12.500	13.750	0.625	318	349	16
25006-6400	23-L	20.000	22.000	0.813	508	559	21	25006-8299	23-L	18.898	20.866	0.787	480	530	20
25006-6401	23-L	22.000	24.000	0.813	559	610	21	25006-8315	23	11.750	13.750	0.813	298	349	21
25006-6408	23-L	18.500	20.500	0.813	470	521	21	25006-8334	23	10.500	11.750	0.500	267	298	13

All dimensions are in inches. Preferred sizes are indicated with **bold** type face. Sizes listed are for standard nitrile elements, except Models 25 and 62 which have PTFE elements. Other material available on inquiry only.



## Oil Seals by Model Number

Product Code	Model	Inches			MM			Product Code	Model	Inches			MM		
		ID	OD	Width	ID	OD	Width			ID	OD	Width	ID	OD	Width
25006-8421	23-L	20.000	21.000	0.500	508	533	13	25009-1652	23	2.375	3.125	0.375	60	79	10
25006-8446	23-L	19.500	21.500	0.813	495	546	21	25009-1736	23	2.437	3.313	0.375	62	84	10
25006-8481	23	8.859	9.842	0.492	225	250	12	25009-1807	23	2.500	3.250	0.375	64	83	10
25006-8483	23	3.938	4.906	0.484	100	125	12	25009-1819	23	2.500	3.500	0.375	64	89	10
25006-8525	23	11.811	13.543	0.807	300	344	20	25009-2024	23	4.910	5.910	0.500	125	150	13
25006-8578	23	7.813	8.813	0.500	198	224	13	25009-2035	23	2.750	3.500	0.375	70	89	10
25006-8580	23	7.188	8.639	0.625	183	219	16	25009-2118	23	2.875	3.750	0.375	73	95	10
25006-8607	23	9.843	11.417	0.630	250	290	16	25009-2146	23	2.938	3.750	0.375	75	95	10
25006-8639	23	3.688	4.688	0.375	94	119	10	25009-2168	23	3.000	3.750	0.375	76	95	10
25006-8665	23	8.500	10.000	0.500	216	254	13	25009-2186	23	3.000	4.500	0.500	76	114	13
25006-8773	23-L	25.625	26.750	0.500	651	679	13	25009-2225	23	3.125	4.125	0.500	79	105	13
25006-8957	23	4.000	5.125	0.375	102	130	10	25009-2364	23	3.500	4.375	0.375	89	111	10
25006-9015	23	3.469	4.500	0.500	88	114	13	25009-2366	23	3.500	4.500	0.500	89	114	13
25006-9056	23	3.375	4.375	0.375	86	111	10	25009-2629	23	6.687	8.250	0.500	170	210	13
25006-9077	23-L	16.000	17.000	0.500	406	432	13	25009-2669	23	4.250	5.750	0.500	108	146	13
25006-9085	23	4.438	5.938	0.500	113	151	13	25009-2772	23	2.948	4.448	0.375	75	113	10
25006-9115	23-L	19.000	21.000	0.750	483	533	19	25009-3096	23	3.820	5.042	0.375	97	128	10
25006-9158	23	5.512	6.692	0.500	140	170	13	25009-3275	23	5.750	6.750	0.500	146	171	13
25006-9172	23	9.250	11.250	0.625	235	286	16	25009-3335	23	5.938	7.000	0.500	151	178	13
25006-9173	23-L	22.938	24.938	0.813	583	633	21	25009-3606	23	8.250	9.500	0.625	210	241	16
25006-9175	23	5.315	6.693	0.472	135	170	12	25009-3840	23	3.812	4.812	0.375	97	122	10
25006-9190	23	3.740	4.724	0.472	95	120	12	25009-4557	23	3.000	4.000	0.500	76	102	13
25006-9197	23	5.813	6.813	0.500	148	173	13	25009-4560	23	6.500	7.500	0.500	165	191	13
25006-9244	23	7.062	8.563	0.500	179	218	13	25009-4651	23	4.000	5.000	0.500	102	127	13
25006-9254	23-L	14.750	16.750	0.750	375	425	19	25009-4705	23	4.437	5.437	0.375	113	138	10
25006-9260	23	9.625	11.125	0.750	244	283	19	25009-4750	23	5.438	6.437	0.500	138	163	13
25006-9285	23-L	16.250	18.000	0.813	413	457	21	25009-4758	23	4.188	5.188	0.375	106	132	10
25006-9316	23-L	13.779	15.279	0.750	350	388	19	25009-5079	23	3.750	5.000	0.500	95	127	13
25006-9382	23-L	25.625	26.625	0.500	651	676	13	25009-6213	23	4.750	5.750	0.375	121	146	10
25006-9404	23	6.750	8.250	0.500	171	210	13	25009-6229	23	6.688	7.688	0.500	170	195	13
25006-9476	23	10.250	11.250	0.500	260	286	13	25009-6358	23	3.500	4.500	0.375	89	114	10
25006-9591	23-L	14.750	16.750	0.813	375	425	21	25009-6359	23	3.625	4.625	0.375	92	117	10
25006-9646	23	3.938	5.062	0.375	100	129	10	25009-6362	23	4.438	5.437	0.500	113	138	13
25006-9662	23	4.000	5.000	0.438	102	127	11	25009-6363	23	4.500	5.500	0.375	114	140	10
25006-9702	23	5.000	5.875	0.375	127	149	10	25009-6365	23	5.000	6.000	0.375	127	152	10
25006-9734	23-L	19.375	21.375	0.813	492	543	21	25009-6383	23	8.500	9.500	0.500	216	241	13
25006-9789	23	6.299	7.299	0.500	160	185	13	25009-6602	23	6.125	7.625	0.625	156	194	16
25006-9820	23-L	50.000	52.000	0.812	1270	1321	21	25009-6625	23	4.125	5.125	0.375	105	130	10
25006-9824	23	4.000	5.031	0.500	102	128	13	25009-6851	23	4.313	5.188	0.375	110	132	10
25006-9862	23	4.313	5.313	0.375	110	135	10	25009-7075	23	3.438	4.438	0.375	87	113	10
25006-9881	23-L	18.500	20.000	0.750	470	508	19	25009-7123	23	4.063	5.063	0.500	103	129	13
25006-9906	23-L	15.125	17.125	0.750	384	435	19	25009-7276	23	6.299	7.480	0.591	160	190	15
25006-9915	23	3.000	4.000	0.438	76	102	11	25009-7389	23	3.750	4.750	0.375	95	121	10
25006-9955	23	7.938	9.188	0.625	202	233	16	25009-7472	23	6.188	7.500	0.625	157	191	16
25006-9960	23	4.250	5.250	0.437	108	133	11	25009-7656	23	3.188	4.188	0.375	81	106	10
25006-9966	23	10.425	12.000	0.625	265	305	16	25009-7838	23-L	23.000	25.000	0.813	584	635	21
25006-9968	23-L	32.375	34.375	1.000	822	873	25	25009-7941	23	3.000	3.938	0.375	76	100	10
25009-0829	23	1.688	2.438	0.375	43	62	10	25009-8252	23	7.500	8.375	0.500	191	213	13
25009-0904	23	1.750	2.500	0.375	44	64	10	25009-8639	23	3.688	4.688	0.375	94	119	10
25009-1204	23	2.000	3.000	0.375	51	76	10	25009-8957	23	4.000	5.125	0.375	102	130	10
25009-1206	23	2.000	3.000	0.500	51	76	13	25009-9056	23	3.375	4.375	0.375	86	111	10
25009-1229	23	5.094	6.586	0.484	129	167	12	25009-9204	23	4.375	5.375	0.375	111	137	10
25009-1408	23	2.188	3.125	0.375	56	79	10	25009-9298	23	3.875	5.000	0.375	98	127	10
25009-1448	23	3.938	5.000	0.400	100	127	10	25009-9646	23	3.938	5.062	0.375	100	129	10
25009-1586	23	3.250	4.225	0.375	83	107	10	25009-9662	23	4.000	5.000	0.438	102	127	11
25009-1642	23	2.375	3.125	0.375	60	79	10	25009-9663	23	5.687	7.187	0.500	144	183	13

All dimensions are in inches. Preferred sizes are indicated with **bold** type face.

Sizes listed are for standard nitrile elements, except Models 25 and 62 which have PTFE elements. Other material available on inquiry only.

## Oil Seals by Model Number

Product Code	Model	Inches			MM			Product Code	Model	Inches			MM		
		ID	OD	Width	ID	OD	Width			ID	OD	Width	ID	OD	Width
25009-9702	23	5.000	5.875	0.375	127	149	10	25010-2780	23	4.563	5.750	0.500	116	146	13
25009-9851	23	4.000	4.938	0.375	102	125	10	25010-2801	23	4.625	5.750	0.500	117	146	13
25009-9944	23	3.438	4.938	0.500	87	125	13	25010-2804	23	4.625	5.875	0.500	117	149	13
25010-0122	23-L	19.943	21.250	0.500	507	540	13	25010-2826	23	6.693	7.874	0.472	170	200	12
25010-0409	23	8.813	10.062	0.437	224	256	11	25010-2828	23	7.087	8.268	0.472	180	210	12
25010-0410	23-L	20.974	22.220	0.500	533	564	13	25010-2837	23	4.750	5.750	0.500	121	146	13
25010-0411	23-L	19.943	21.750	0.500	507	552	13	25010-2843	23	4.750	6.000	0.500	121	152	13
25010-0412	23-L	20.992	22.000	0.375	533	559	10	25010-2873	23	4.875	6.000	0.500	124	152	13
25010-0414	23-L	19.974	21.000	0.375	507	533	10	25010-2887	23	4.921	5.906	0.472	125	150	12
25010-0518	23-L	18.110	19.844	0.787	460	504	20	25010-2900	23	4.938	6.250	0.500	125	159	13
25010-0578	23	6.299	7.943	0.625	160	202	16	25010-2915	23	5.000	6.000	0.500	127	152	13
25010-0801	23	7.283	8.268	0.500	185	210	13	25010-2921	23	5.000	6.250	0.500	127	159	13
25010-0962	23	4.563	5.875	0.563	116	149	14	25010-2940	23	11.417	13.150	0.787	290	334	20
25010-1010	23	3.740	4.921	0.472	95	125	12	25010-2990	23	5.125	6.125	0.500	130	156	13
25010-1097	23	9.449	11.024	0.500	240	280	13	25010-3059	23	5.250	6.250	0.500	133	159	13
25010-1110	23	3.740	4.740	0.375	95	120	10	25010-3065	23	5.250	6.500	0.500	133	165	13
25010-1111	23	5.905	7.087	0.512	150	180	13	25010-3131	23	5.375	6.750	0.500	137	171	13
25010-1157	23	9.056	11.024	0.788	230	280	20	25010-3152	23	5.438	6.625	0.500	138	168	13
25010-1159	23	4.449	5.472	0.625	113	139	16	25010-3176	23	5.500	6.500	0.500	140	165	13
25010-1179	23-L	17.716	19.685	0.813	450	500	21	25010-3275	23	5.750	6.750	0.500	146	171	13
25010-1202	23-L	14.173	15.905	0.787	360	404	20	25010-3281	23	5.750	7.000	0.500	146	178	13
25010-1320	23	2.125	2.875	0.438	54	73	11	25010-3319	23	5.875	7.000	0.500	149	178	13
25010-1443	23	9.250	10.236	0.393	235	260	10	25010-3327	23	5.906	7.087	0.591	150	180	15
25010-1465	23	11.031	12.031	0.500	280	306	13	25010-3335	23	5.938	7.000	0.500	151	178	13
25010-1480	23	2.250	3.125	0.375	57	79	10	25010-3355	23	6.000	7.000	0.500	152	178	13
25010-1493	23	2.250	3.250	0.438	57	83	11	25010-3369	23	6.000	7.500	0.625	152	191	16
25010-1535	23-L	20.000	21.968	0.787	508	558	20	25010-3381	23	6.125	7.375	0.500	156	187	13
25010-1598	23-L	149.842	151.810	0.787	3806	3856	20	25010-3406	23	6.375	7.375	0.500	162	187	13
25010-1832	23	6.500	7.500	0.375	165	191	10	25010-3411	23	3.407	4.407	0.500	87	112	13
25010-1885	23	2.562	3.500	0.375	65	89	10	25010-3435	23	6.500	8.000	0.750	165	203	19
25010-1894	23	2.563	3.751	0.375	65	95	10	25010-3496	23	7.000	8.250	0.625	178	210	16
25010-1926	23	11.418	13.386	0.748	290	340	19	25010-3500	23	7.000	8.500	0.625	178	216	16
25010-2000	23	4.134	5.118	0.500	105	130	13	25010-3512	23	7.125	8.500	0.625	181	216	16
25010-2035	23	2.750	3.500	0.375	70	89	10	25010-3522	23	7.250	8.500	0.625	184	216	16
25010-2146	23	2.938	3.750	0.375	75	95	10	25010-3587	23	7.875	9.250	0.750	200	235	19
25010-2168	23	3.000	3.751	0.375	76	95	10	25010-3588	23	7.875	9.375	0.625	200	238	16
25010-2174	23	3.000	4.003	0.375	76	102	10	25010-3606	23	8.250	9.500	0.625	210	241	16
25010-2225	23	3.125	4.125	0.500	79	105	13	25010-3623	23	9.000	11.000	0.750	229	279	19
25010-2245	23-L	13.386	15.118	0.787	340	384	20	25010-3627	23-L	174.700	176.200	0.750	4437	4475	19
25010-2270	23	3.250	4.249	0.500	83	108	13	25010-3632	23	9.250	10.750	0.750	235	273	19
25010-2348	23	3.438	4.625	0.500	87	117	13	25010-3636	23	9.438	10.625	0.750	240	270	19
25010-2359	23-L	25.591	27.559	0.787	650	700	20	25010-3672	23	10.000	11.500	0.750	254	292	19
25010-2440	23	11.024	12.795	0.866	280	325	22	25010-3692	23	11.000	12.250	0.625	279	311	16
25010-2443	23	11.811	13.583	0.866	300	345	22	25010-3733	23	5.512	6.772	0.591	140	172	15
25010-2445	23-L	12.992	14.961	0.866	330	380	22	25010-3741	23-L	18.000	19.500	0.750	457	495	19
25010-2446	23-L	14.173	15.945	0.984	360	405	25	25010-3821	23-L	28.500	31.000	0.750	724	787	19
25010-2465	23	3.750	4.875	0.500	95	124	13	25010-3885	23	1.750	3.189	0.500	44	81	13
25010-2505	23-L	20.000	21.250	0.625	508	540	16	25010-3935	23	8.500	9.500	0.625	216	241	16
25010-2543	23	4.000	5.250	0.500	102	133	13	25010-3937	23	8.500	10.000	0.750	216	254	19
25010-2582	23	11.024	12.205	0.630	280	310	16	25010-3960	23-L	19.685	21.260	0.787	500	540	20
25010-2625	23-L	16.535	17.913	0.787	420	455	20	25010-3967	23	9.250	11.250	0.750	235	286	19
25010-2663	23	4.250	5.500	0.500	108	140	13	25010-3992	23	10.000	11.500	0.688	254	292	17
25010-2686	23-L	45.500	47.000	0.750	1156	1194	19	25010-4058	23	11.500	13.000	0.750	292	330	19
25010-2753	23	4.500	5.500	0.500	114	140	13	25010-4072	23-L	12.000	14.000	0.813	305	356	21
25010-2759	23	4.500	5.750	0.500	114	146	13	25010-4080	23-L	12.500	14.000	0.750	318	356	19
25010-2765	23	4.500	6.000	0.500	114	152	13	25010-4122	23-L	13.500	15.000	0.750	343	381	19

All dimensions are in inches. Preferred sizes are indicated with **bold** type face. Sizes listed are for standard nitrile elements, except Models 25 and 62 which have PTFE elements. Other material available on inquiry only.

## Oil Seals by Model Number

Product Code	Model	Inches			MM			Product Code	Model	Inches			MM		
		ID	OD	Width	ID	OD	Width			ID	OD	Width	ID	OD	Width
25010-4143	23-L	14.500	16.000	0.750	368	406	19	25010-6408	23-L	18.500	20.500	0.812	470	521	21
25010-4152	23-L	15.000	16.500	0.750	381	419	19	25010-6483	23-L	26.000	28.000	0.813	660	711	21
25010-4156	23-L	15.000	17.000	0.812	381	432	21	25010-6535	23-L	21.000	23.000	0.813	533	584	21
25010-4178	23-L	16.000	17.500	0.750	406	445	19	25010-6561	23	4.938	5.938	0.500	125	151	13
25010-4180	23-L	16.000	18.000	0.812	406	457	21	25010-6648	23	9.375	10.625	0.625	238	270	16
25010-4200	23-L	17.750	19.750	0.813	451	502	21	25010-6710	23-L	20.125	22.125	0.813	511	562	21
25010-4211	23-L	18.250	19.750	0.750	464	502	19	25010-6786	23-L	28.000	30.000	0.812	711	762	21
25010-4217	23-L	18.750	20.250	0.750	476	514	19	25010-6867	23	6.299	7.549	0.625	160	192	16
25010-4402	23	2.953	3.953	0.375	75	100	10	25010-6926	23	7.874	9.291	0.748	200	236	19
25010-4403	23-L	17.500	19.000	0.625	445	483	16	25010-7117	23	5.906	7.410	0.625	150	188	16
25010-4470	23-L	29.528	32.047	0.812	750	814	21	25010-7127	23-L	16.535	18.035	0.750	420	458	19
25010-4478	23	6.938	8.375	0.625	176	213	16	25010-7132	23	5.313	6.313	0.500	135	160	13
25010-4505	23	9.000	10.250	0.625	229	260	16	25010-7149	23-L	14.500	16.000	0.625	368	406	16
25010-4511	23	9.250	10.500	0.625	235	267	16	25010-7213	23	3.125	3.875	0.375	79	98	10
25010-4560	23	6.500	7.500	0.500	165	191	13	25010-7266	23-L	22.047	24.016	0.787	560	610	20
25010-4624	23	6.889	7.874	0.591	175	200	15	25010-7267	23	5.512	6.693	0.591	140	170	15
25010-4651	23	4.000	5.000	0.500	102	127	13	25010-7268	23	6.693	7.875	0.591	170	200	15
25010-4656	23	5.118	6.299	0.472	130	160	12	25010-7306	23	12.000	13.250	0.625	305	337	16
25010-4707	23	12.000	13.500	0.625	305	343	16	25010-7388	23	7.875	9.055	0.591	200	230	15
25010-4750	23	5.438	6.438	0.500	138	164	13	25010-7391	23	11.024	12.598	0.787	280	320	20
25010-4805	23	10.236	11.968	0.787	260	304	20	25010-7396	23	4.331	5.512	0.472	110	140	12
25010-4817	23	3.938	4.938	0.500	100	125	13	25010-7413	23-L	18.000	19.750	0.812	457	502	21
25010-4856	23-L	62.000	64.000	0.813	1575	1626	21	25010-7464	23	3.740	4.990	0.500	95	127	13
25010-4950	23	10.000	11.500	0.625	254	292	16	25010-7805	23-L	13.000	14.500	0.625	330	368	16
25010-4969	23-L	13.000	14.125	0.547	330	359	14	25010-7812	23	7.187	8.187	0.500	183	208	13
25010-5025	23	3.125	4.250	0.500	79	108	13	25010-7825	23-L	49.250	51.125	0.812	1251	1299	21
25010-5116	23-L	16.000	18.000	0.750	406	457	19	25010-7838	23-L	23.000	25.000	0.813	584	635	21
25010-5189	23	5.125	6.125	0.375	130	156	10	25010-7924	23	6.437	7.687	0.625	163	195	16
25010-5290	23-L	15.354	16.929	0.750	390	430	19	25010-8123	23-L	15.000	16.750	0.813	381	425	21
25010-5337	23	7.875	9.055	0.492	200	230	12	25010-8177	23	8.875	10.375	0.500	225	264	13
25010-5367	23	5.118	6.259	0.472	130	159	12	25010-8420	23	7.874	9.448	0.629	200	240	16
25010-5372	23	7.875	9.448	0.618	200	240	16	25010-8429	23	3.543	4.724	0.500	90	120	13
25010-5607	23-L	27.000	29.000	0.750	686	737	19	25010-8483	23	3.938	4.906	0.484	100	125	12
25010-5628	23	6.300	7.781	0.500	160	198	13	25010-8699	23	6.693	7.943	0.625	170	202	16
25010-5665	23	10.236	11.732	0.750	260	298	19	25010-9162	23	2.559	3.543	0.375	65	90	10
25010-5846	23-L	14.173	15.673	0.750	360	398	19	25010-9172	23	9.250	11.250	0.625	235	286	16
25010-5881	23	10.629	12.119	0.750	270	308	19	25010-9175	23	5.315	6.693	0.472	135	170	12
25010-5919	23-L	24.000	26.000	0.812	610	660	21	25010-9243	23	8.661	9.911	0.625	220	252	16
25010-5942	23-L	12.750	14.250	0.750	324	362	19	25010-9394	23-L	55.000	56.500	0.750	1397	1435	19
25010-6142	23	4.125	5.500	0.438	105	140	11	25010-9395	23-L	53.500	55.000	0.750	1359	1397	19
25010-6165	23	6.000	7.000	0.438	152	178	11	25010-9476	23	10.250	11.250	0.500	260	286	13
25010-6264	23-L	13.250	15.250	0.750	337	387	19	25010-9491	23	11.813	13.313	0.750	300	338	19
25010-6285	23	3.500	4.375	0.500	89	111	13	25010-9676	23	9.844	11.020	0.500	250	280	13
25010-6291	23-L	22.000	23.750	0.812	559	603	21	25010-9693	23	11.000	12.000	0.500	279	305	13
25010-6356	23	3.250	4.250	0.375	83	108	10	25010-9751	23	5.906	6.906	0.500	150	175	13
25010-6358	23	3.500	4.500	0.375	89	114	10	25010-9789	23	6.299	7.299	0.500	160	185	13
25010-6367	23	5.437	6.687	0.625	138	170	16	25010-9915	23	3.000	4.000	0.438	76	102	11
25010-6376	23	7.250	8.250	0.500	184	210	13	25010-9939	23	6.000	7.000	0.375	152	178	10
25010-6380	23	8.000	9.000	0.500	203	229	13	25010-9998	23-L	20.991	22.125	0.563	533	562	14
25010-6383	23	8.500	9.500	0.500	216	241	13	25011-2440	23	11.024	12.796	0.866	280	325	22
25010-6388	23	9.500	10.500	0.500	241	267	13	25011-3971	23	9.375	10.875	0.750	238	276	19
25010-6390	23	9.750	11.000	0.500	248	279	13	25011-4132	23-L	14.000	15.500	0.750	356	394	19
25010-6391	23	10.000	11.000	0.500	254	279	13	25011-6648	23	9.375	10.625	0.625	238	270	16
25010-6399	23-L	18.000	20.000	0.812	457	508	21	25011-6710	23-L	20.125	22.125	0.812	511	562	21
25010-6400	23-L	20.000	22.000	0.812	508	559	21	25011-7889	23	9.625	10.625	0.500	244	270	13
25010-6401	23-L	22.000	24.000	0.813	559	610	21	25011-8576	23-L	13.000	14.000	0.500	330	356	13

All dimensions are in inches. Preferred sizes are indicated with **bold** type face.

Sizes listed are for standard nitrile elements, except Models 25 and 62 which have PTFE elements. Other material available on inquiry only.

## Oil Seals by Model Number

Product Code	Model	Inches			MM			Product Code	Model	Inches			MM		
		ID	OD	Width	ID	OD	Width			ID	OD	Width	ID	OD	Width
25015-8299	23-L	18.898	20.866	0.787	480	530	20	25054-0786	23-L	28.346	30.315	0.984	720	770	25
25015-8464	23-L	15.157	16.732	0.787	385	425	20	25054-2537	23	4.000	4.999	0.500	102	127	13
25015-9396	23-L	12.438	14.000	0.750	316	356	19	25054-3128	23	5.375	6.625	0.500	137	168	13
25017-3631	23-L	169.760	171.260	0.750	4312	4350	19	25054-4464	23-L	133.406	135.030	1.000	3389	3430	25
25021-3244	23-L	16.875	18.375	0.750	429	467	19	25054-4466	23-L	130.265	131.890	1.000	3309	3350	25
25021-3672	23	10.000	11.500	0.750	254	292	19	25054-5294	23	10.625	11.625	0.415	270	295	11
25021-6775	23-L	51.000	53.000	0.813	1295	1346	21	25054-5789	23	7.875	8.938	0.500	200	227	13
25021-8108	23-L	23.875	24.875	0.500	606	632	13	25054-5798	23-L	25.000	26.000	0.500	635	660	13
25025-6390	23	9.750	11.000	0.500	248	279	13	25054-6367	23	5.438	6.688	0.625	138	170	16
25045-0506	23-L	22.625	24.125	0.500	575	613	13	25054-6835	23-L	36.465	38.465	1.000	926	977	25
25045-0614	23-L	14.961	16.535	0.787	380	420	20	25054-7431	23-L	15.500	17.500	0.750	394	445	19
25045-0932	23	11.417	13.417	0.812	290	341	21	25054-7646	23-L	25.438	27.188	0.750	646	691	19
25045-0935	23-L	20.470	22.470	0.812	520	571	21	25054-7924	23	6.437	7.687	0.625	163	195	16
25045-1273	23-L	25.000	26.811	0.813	635	681	21	25054-8276	23	2.344	3.219	0.625	60	82	16
25045-1780	23-L	19.625	21.125	0.500	498	537	13	25054-8421	23-L	20.000	21.000	0.500	508	533	13
25045-2012	23-L	19.000	21.000	0.781	483	533	20	25054-8494	23	9.000	10.500	0.609	229	267	15
25045-2457	23	6.890	8.071	0.591	175	205	15	25054-8580	23	7.187	8.639	0.625	183	219	16
25045-2462	23	3.750	4.750	0.500	95	121	13	25054-9602	23-L	39.000	40.000	0.500	991	1016	13
25045-2753	23	4.500	5.500	0.500	114	140	13	25054-9662	23	4.000	5.000	0.438	102	127	11
25045-2765	23	4.500	6.000	0.500	114	152	13	25054-9877	23	4.125	5.250	0.406	105	133	10
25045-2915	23	5.000	6.000	0.500	127	152	13	25054-9919	23-L	54.331	56.299	0.984	1380	1430	25
25045-2923	23	5.000	6.250	0.625	127	159	16	25054-9979	23-L	18.750	19.750	0.500	476	502	13
25045-3162	23	4.750	5.750	0.484	121	146	12	25072-8962	23	11.500	12.500	0.375	292	318	10
25045-3184	23	5.500	6.750	0.625	140	171	16	25087-2366	23	3.500	4.500	0.500	89	114	13
25045-3244	23-L	16.875	18.375	0.750	429	467	19	25087-2474	23	3.750	5.250	0.500	95	133	13
25045-3492	23	7.000	8.000	0.625	178	203	16	25087-2657	23	4.250	5.250	0.500	108	133	13
25045-4058	23	11.500	13.000	0.750	292	330	19	25087-2702	23	3.820	5.042	0.395	97	128	10
25045-4152	23-L	15.000	16.500	0.750	381	419	19	25087-2870	23	4.875	5.875	0.500	124	149	13
25045-4269	23-L	22.000	23.500	0.750	559	597	19	25087-2915	23	5.000	6.000	0.500	127	152	13
25045-4843	23-L	25.000	27.000	0.790	635	686	20	25087-4862	23	5.906	7.283	0.708	150	185	18
25045-5635	23	4.217	5.280	0.500	107	134	13	25087-6919	23	4.375	5.875	0.375	111	149	10
25045-5828	23-L	25.188	27.188	0.813	640	691	21	25087-7590	23	4.250	5.250	0.375	108	133	10
25045-5919	23-L	24.000	26.000	0.813	610	660	21	25087-7813	23-L	36.500	38.500	0.813	927	978	21
25045-6355	23	3.438	4.438	0.500	87	113	13	25087-9298	23	3.875	5.000	0.375	98	127	10
25045-6362	23	4.438	5.438	0.500	113	138	13	25087-9646	23	3.938	5.062	0.375	100	129	10
25045-6400	23-L	20.000	22.000	0.813	508	559	21	25087-9648	23	4.000	5.131	0.375	102	130	10
25045-6424	23-L	70.000	72.000	0.813	1778	1829	21	25113-5524	23	2.625	3.435	0.480	67	87	12
25045-6508	23-L	19.000	21.000	0.812	483	533	21	25113-7179	23	2.375	3.313	0.480	60	84	12
25045-6535	23-L	21.000	23.000	0.813	533	584	21	25113-8274	23	2.375	3.362	0.480	60	85	12
25045-6560	23-L	14.000	15.000	0.500	356	381	13	25135-1088	23-L	29.750	31.750	0.750	756	806	19
25045-6775	23-L	51.000	53.000	0.813	1295	1346	21	25135-1515	23	3.625	4.609	0.492	92	117	12
25045-6813	23	8.875	9.875	0.500	225	251	13	25135-1516	23	4.375	5.359	0.492	111	136	12
25045-6910	23-L	23.250	25.250	0.813	591	641	21	25135-1517	23	5.250	6.234	0.492	133	158	12
25045-7200	23-L	24.750	26.750	0.813	629	679	21	25135-1518	23	6.375	7.359	0.492	162	187	12
25045-7592	23-L	15.565	16.565	0.500	395	421	13	25135-1519	23	7.750	8.734	0.492	197	222	12
25045-7827	23-L	43.000	45.000	0.813	1092	1143	21	25135-1521	23	9.500	10.484	0.492	241	266	12
25045-7838	23-L	23.000	25.000	0.813	584	635	21	25135-1522	23	11.750	12.734	0.492	298	323	12
25045-8108	23-L	23.875	24.875	0.500	606	632	13	25135-1524	23	6.125	7.307	0.591	156	186	15
25045-8299	23-L	18.898	20.866	0.787	480	530	20	25135-1525	23	7.500	8.682	0.591	191	221	15
25045-8332	23-L	13.188	14.188	0.500	335	360	13	25135-1526	23	9.250	10.432	0.591	235	265	15
25045-8481	23	8.859	9.842	0.492	225	250	12	25135-1527	23	11.250	12.432	0.591	286	316	15
25045-8872	23-L	66.500	69.000	0.813	1689	1753	21	25135-1528	23-L	13.875	15.057	0.591	352	382	15
25045-9371	23-L	23.250	25.250	0.750	591	641	19	25135-1530	23	10.500	12.074	0.787	267	307	20
25045-9476	23	10.250	11.250	0.500	260	286	13	25135-1531	23-L	13.000	14.574	0.787	330	370	20
25045-9561	23-L	18.750	20.750	0.750	476	527	19	25135-1532	23-L	16.125	17.699	0.787	410	450	20
25045-9647	23-L	26.750	28.750	0.812	679	730	21	25135-1533	23-L	20.000	21.574	0.787	508	548	20

All dimensions are in inches. Preferred sizes are indicated with **bold** type face. Sizes listed are for standard nitrile elements, except Models 25 and 62 which have PTFE elements. Other material available on inquiry only.

## Oil Seals by Model Number

Product Code	Model	Inches			MM			Product Code	Model	Inches			MM		
		ID	OD	Width	ID	OD	Width			ID	OD	Width	ID	OD	Width
25135-1534	23-L	16.125	18.093	0.787	410	460	20	25145-3496	23	7.000	8.250	0.625	178	210	16
25135-1535	23-L	20.000	21.968	0.787	508	558	20	25145-4557	23	3.000	4.000	0.500	76	102	13
25135-2462	23	3.750	4.750	0.500	95	121	13	25145-6408	23-L	18.500	20.500	0.813	470	521	21
25135-3361	23	6.000	7.250	0.500	152	184	13	25145-6853	23-L	21.500	23.000	0.625	546	584	16
25135-3375	23	6.125	7.125	0.500	156	181	13	25145-8976	23	10.375	11.875	0.750	264	302	19
25135-3430	23	6.500	7.750	0.625	165	197	16	25166-3885	23	1.750	3.189	0.500	44	81	13
25135-4050	23	11.375	12.875	0.750	289	327	19	25166-7430	23	2.431	3.447	0.688	62	88	17
25135-4132	23-L	14.000	15.500	0.750	356	394	19	25166-7434	23	2.125	3.136	0.688	54	80	17
25135-4370	23-L	20.000	21.968	0.767	508	558	19	25205-6419	23-L	25.000	27.000	0.813	635	686	21
25135-4515	23	9.750	11.000	0.625	248	279	16	25270-2701	23	2.875	3.750	0.395	73	95	10
25135-4560	23	6.500	7.500	0.500	165	191	13	25278-5023	23	3.000	4.000	0.375	76	102	10
25135-4663	23-L	17.250	18.750	0.625	438	476	16	25284-0754	23	1.975	2.850	0.625	50	72	16
25135-4749	23	8.125	9.375	0.625	206	238	16	25284-0961	23	8.465	9.764	0.590	215	248	15
25135-5783	23-L	13.125	15.125	0.813	333	384	21	25284-1041	23	3.720	4.720	0.500	94	120	13
25135-5880	23	4.875	5.938	0.500	124	151	13	25284-1642	23	2.375	3.125	0.375	60	79	10
25135-6363	23	4.500	5.500	0.375	114	140	10	25284-2118	23	2.875	3.750	0.375	73	95	10
25135-7608	23	11.375	12.875	0.625	289	327	16	25284-2140	23	2.937	3.937	0.500	75	100	13
25138-1480	23	2.250	3.125	0.375	57	79	10	25284-2201	23	3.063	4.125	0.500	78	105	13
25138-2054	23	2.750	3.625	0.437	70	92	11	25284-2701	23	2.875	3.750	0.395	73	95	10
25138-2462	23	3.750	4.750	0.500	95	121	13	25284-2702	23	3.820	5.042	0.395	97	128	10
25138-2657	23	4.250	5.250	0.500	108	133	13	25284-2741	23	4.310	5.348	0.395	109	136	10
25138-2753	23	4.500	5.500	0.500	114	140	13	25284-2870	23	4.875	5.875	0.500	124	149	13
25138-2837	23	4.750	5.750	0.500	121	146	13	25284-2882	23	4.875	6.375	0.500	124	162	13
25138-3059	23	5.250	6.250	0.500	133	159	13	25284-2924	23	5.000	6.375	0.500	127	162	13
25138-3355	23	6.000	7.000	0.500	152	178	13	25284-3012	23	4.310	5.348	0.375	109	136	10
25138-3672	23	10.000	11.500	0.750	254	292	19	25284-3096	23	3.819	5.042	0.375	97	128	10
25138-4143	23-L	14.500	16.000	0.750	368	406	19	25284-3176	23	5.500	6.500	0.500	140	165	13
25138-4189	23-L	17.000	18.500	0.750	432	470	19	25284-3349	23	2.938	4.063	0.375	75	103	10
25138-4496	23-L	12.500	14.000	0.625	318	356	16	25284-3370	23	6.000	7.500	0.750	152	191	19
25138-4557	23	3.000	4.000	0.500	76	102	13	25284-3786	23	5.000	5.875	0.395	127	149	10
25138-4817	23	3.938	4.938	0.500	100	125	13	25284-4651	23	4.000	5.000	0.500	102	127	13
25138-5386	23-L	44.000	46.000	0.812	1118	1168	21	25284-4705	23	4.438	5.437	0.375	113	138	10
25138-5804	23-L	42.250	44.250	0.812	1073	1124	21	25284-4750	23	5.438	6.438	0.500	138	164	13
25138-6391	23	10.000	11.000	0.500	254	279	13	25284-4772	23	3.875	5.000	0.500	98	127	13
25138-6408	23-L	18.500	20.500	0.813	470	521	21	25284-4804	23	3.000	4.250	0.500	76	108	13
25138-6839	23	3.250	4.250	0.438	83	108	11	25284-5023	23	3.000	4.000	0.375	76	102	10
25138-6853	23-L	21.500	23.000	0.625	546	584	16	25284-6213	23	4.750	5.750	0.375	121	146	10
25138-8976	23	10.375	11.875	0.750	264	302	19	25284-6351	23	2.938	3.938	0.500	75	100	13
25144-2462	23	3.750	4.750	0.500	95	121	13	25284-6360	23	4.000	5.000	0.375	102	127	10
25144-2753	23	4.500	5.500	0.500	114	140	13	25284-6375	23	7.000	8.500	0.500	178	216	13
25144-2765	23	4.500	6.000	0.500	114	152	13	25284-6851	23	4.312	5.187	0.375	110	132	10
25144-3067	23	5.250	6.500	0.625	133	165	16	25284-6919	23	4.375	5.875	0.375	111	149	10
25144-3122	23	5.375	6.375	0.500	137	162	13	25284-6939	23	5.000	6.500	0.750	127	165	19
25144-3971	23	9.375	10.875	0.750	238	276	19	25284-7075	23	3.438	4.438	0.375	87	113	10
25144-4132	23-L	14.000	15.500	0.750	356	394	19	25284-7298	23	5.938	6.938	0.500	151	176	13
25144-4143	23-L	14.500	16.000	0.750	368	406	19	25284-8790	23	3.938	4.906	0.500	100	125	13
25144-4560	23	6.500	7.500	0.500	165	191	13	25284-9230	23	3.000	4.062	0.375	76	103	10
25144-6370	23	6.500	8.000	0.500	165	203	13	25284-9298	23	3.875	5.000	0.375	98	127	10
25144-6379	23	7.750	8.750	0.500	197	222	13	25284-9646	23	3.938	5.062	0.375	100	129	10
25144-6397	23-L	16.250	18.250	0.813	413	464	21	25284-9663	23	5.687	7.187	0.500	144	183	13
25144-6428	23	10.625	12.625	0.813	270	321	21	25284-9702	23	5.000	5.875	0.375	127	149	10
25144-6710	23-L	20.125	22.125	0.813	511	562	21	25284-9915	23	3.000	4.000	0.437	76	102	11
25144-6967	23-L	17.250	18.750	0.750	438	476	19	25284-9944	23	3.438	4.937	0.500	87	125	13
25144-7889	23	9.625	10.625	0.500	244	270	13	25287-2168	23	3.000	3.751	0.375	76	95	10
25144-8580	23	7.188	8.639	0.625	183	219	16	25287-3096	23	3.820	5.042	0.375	97	128	10
25145-2780	23	4.563	5.750	0.500	116	146	13	25287-9646	23	3.938	5.063	0.375	100	129	10

All dimensions are in inches. Preferred sizes are indicated with **bold** type face.

Sizes listed are for standard nitrile elements, except Models 25 and 62 which have PTFE elements. Other material available on inquiry only.

## Oil Seals by Model Number

Product Code	Model	Inches			MM			Product Code	Model	Inches			MM		
		ID	OD	Width	ID	OD	Width			ID	OD	Width	ID	OD	Width
25005-2879	24	4.875	6.250	0.500	124	159	13	25058-2168	25	3.000	3.750	0.375	76	95	10
25005-3240	24	5.625	7.125	0.500	143	181	13	25058-2176	25	3.000	4.003	0.500	76	102	13
25005-3287	24	5.750	7.250	0.500	146	184	13	25058-2192	25	3.000	4.750	0.500	76	121	13
25005-3367	24	6.000	7.500	0.500	152	191	13	25058-2249	25	3.188	4.250	0.500	81	108	13
25005-3996	24	10.000	12.000	0.750	254	305	19	25058-2276	25	3.250	4.500	0.500	83	114	13
25005-4098	24-L	13.000	15.000	0.750	330	381	19	25058-2366	25	3.500	4.500	0.500	89	114	13
25005-5139	24	6.625	8.125	0.500	168	206	13	25058-2462	25	3.750	4.750	0.500	95	121	13
25005-6247	24	8.250	9.750	0.500	210	248	13	25058-2657	25	4.250	5.250	0.500	108	133	13
25005-6375	24	7.000	8.500	0.500	178	216	13	25058-2915	25	5.000	6.000	0.500	127	152	13
25005-6380	24	8.000	9.000	0.500	203	229	13	25058-2918	25	5.000	6.125	0.500	127	156	13
25005-6395	24	11.000	13.000	0.750	279	330	19	25058-2923	25	5.000	6.250	0.625	127	159	16
25005-6693	24-L	16.000	18.000	0.500	406	457	13	25058-2973	25	5.000	6.437	0.500	127	163	13
25005-6758	24	10.438	12.438	0.750	265	316	19	25058-3122	25	5.375	6.375	0.500	137	162	13
25005-6773	24	7.500	9.000	0.500	191	229	13	25058-3355	25	6.000	7.000	0.500	152	178	13
25005-7758	24	8.000	9.500	0.500	203	241	13	25058-3367	25	6.000	7.500	0.500	152	191	13
25005-8171	24	6.500	7.875	0.472	165	200	12	25058-3370	25	6.000	7.500	0.750	152	191	19
25005-8452	24	8.375	9.875	0.500	213	251	13	25058-3496	25	7.000	8.250	0.625	178	210	16
25005-8665	24	8.500	10.000	0.500	216	254	13	25058-3552	25	7.500	9.000	0.625	191	229	16
25005-9035	24-L	21.500	23.500	0.500	546	597	13	25058-3619	25	9.000	10.500	0.750	229	267	19
25005-9108	24	9.000	10.375	0.500	229	264	13	25058-3652	25	9.750	11.000	0.750	248	279	19
25005-9663	24	5.688	7.188	0.500	144	183	13	25058-3673	25	10.000	12.000	1.000	254	305	25
25005-9930	24	5.000	6.563	0.500	127	167	13	25058-3979	25	9.500	11.000	0.750	241	279	19
25005-9937	24	12.875	15.000	0.750	327	381	19	25058-4032	25	10.875	12.375	0.750	276	314	19
25005-9951	24	6.693	8.193	0.500	170	208	13	25058-4050	25	11.375	12.875	0.750	289	327	19
25005-9952	24	5.905	7.405	0.500	150	188	13	25058-4058	25	11.500	13.000	0.750	292	330	19
25030-8173	24	7.125	8.625	0.500	181	219	13	25058-4152	25	15.000	16.500	0.750	381	419	19
25030-8452	24	8.375	9.875	0.500	213	251	13	25058-4502	25	8.500	10.000	0.625	216	254	16
25007-2915	25	5.000	6.000	0.500	127	152	13	25058-4505	25	9.000	10.250	0.625	229	260	16
25007-3355	25	6.000	7.000	0.500	152	178	13	25058-4517	25	9.750	11.250	0.625	248	286	16
25007-3410	25	11.950	13.500	0.625	304	343	16	25058-4557	25	3.000	4.000	0.500	76	102	13
25007-4560	25	6.500	7.500	0.500	165	191	13	25058-4551	25	4.000	5.000	0.500	102	127	13
25007-6374	25	7.000	8.000	0.500	178	203	13	25058-4799	25	8.375	9.875	0.625	213	251	16
25048-0502	25	4.724	5.709	0.492	120	145	12	25058-4923	25	10.000	11.250	0.500	254	286	13
25048-2171	25	3.000	3.875	0.375	76	98	10	25058-5023	25	3.000	4.000	0.375	76	102	10
25048-3043	25	7.874	9.449	0.512	200	240	13	25058-5240	25	2.375	4.000	0.500	60	102	13
25048-6380	25	8.000	9.000	0.500	203	229	13	25058-5825	25	13.625	14.875	0.750	346	378	19
25048-6709	25	3.938	4.938	0.375	100	125	10	25058-5913	25	3.938	5.000	0.500	100	127	13
25056-0396	25	1.375	3.250	0.375	35	83	10	25058-5934	25	10.500	11.750	0.625	267	298	16
25056-1010	25	3.740	4.921	0.472	95	125	12	25058-6356	25	3.250	4.250	0.375	83	108	10
25056-2923	25	5.000	6.250	0.625	127	159	16	25058-6360	25	4.000	5.000	0.375	102	127	10
25058-0353	25	1.125	1.750	0.375	29	44	10	25058-6363	25	4.500	5.500	0.375	114	140	10
25058-0427	25	1.250	2.000	0.375	32	51	10	25058-6374	25	7.000	8.000	0.500	178	203	13
25058-0544	25	1.375	2.250	0.375	35	57	10	25058-6380	25	8.000	9.000	0.500	203	229	13
25058-0655	25	1.500	2.500	0.375	38	64	10	25058-6382	25	8.250	9.250	0.500	210	235	13
25058-0813	25	1.750	2.375	0.375	44	60	10	25058-6387	25	9.000	10.000	0.500	229	254	13
25058-0814	25	1.437	2.062	0.375	36	52	10	25058-6471	25	2.750	3.750	0.500	70	95	13
25058-1189	25	2.000	2.750	0.375	51	70	10	25058-7033	25	0.750	1.250	0.250	19	32	6
25058-1204	25	2.000	3.000	0.375	51	76	10	25058-7133	25	7.938	9.438	0.750	202	240	19
25058-1205	25	2.000	3.000	0.437	51	76	11	25058-7293	25	1.000	1.500	0.281	25	38	7
25058-1404	25	2.188	3.000	0.500	56	76	13	25058-8782	25	5.438	6.938	0.750	138	176	19
25058-1494	25	2.250	3.250	0.500	57	83	13	25058-9145	25	9.938	11.438	0.750	252	291	19
25058-1637	25	2.375	3.375	0.469	60	86	12	25058-9207	25	8.500	9.750	0.750	216	248	19
25058-1807	25	2.500	3.250	0.375	64	83	10	25059-3355	25	6.000	7.000	0.500	152	178	13
25058-1809	25	2.500	3.250	0.500	64	83	13	25059-4152	25	15.000	16.500	0.750	381	419	19
25058-1939	25	2.625	3.500	0.375	67	89	10	25059-6285	25	3.500	4.375	0.500	89	111	13
25058-2152	25	2.938	4.003	0.375	75	102	10	25059-6380	25	8.000	9.000	0.500	203	229	13

All dimensions are in inches. Preferred sizes are indicated with **bold** type face. Sizes listed are for standard nitrile elements, except Models 25 and 62 which have PTFE elements. Other material available on inquiry only.

## Oil Seals by Model Number

Product Code	Model	Inches			MM			Product Code	Model	Inches			MM		
		ID	OD	Width	ID	OD	Width			ID	OD	Width	ID	OD	Width
25064-0942	25	3.313	4.336	0.500	84	110	13	24600-0839	26	3.375	4.250	0.375	86	108	10
25064-2102	25	2.625	4.000	0.500	67	102	13	24600-0840	26	1.688	2.625	0.500	43	67	13
25064-6374	25	7.000	8.000	0.500	178	203	13	24600-0841	26	4.527	5.708	0.551	115	145	14
25064-7841	25	3.313	4.313	0.500	84	110	13	24600-0842	26	1.125	2.001	0.375	29	51	10
24600-0041	26-L	9.250	10.500	0.625	235	267	16	24600-0845	26	2.781	3.500	0.375	71	89	10
24600-0044	26-L	9.250	11.250	0.750	235	286	19	24600-0874	26	1.500	3.000	0.500	38	76	13
24600-0055	26-L	9.500	11.500	0.625	241	292	16	24600-0876	26	1.625	2.875	0.500	41	73	13
24600-0126	26-L	11.500	13.000	0.625	292	330	16	24600-0898	26	1.750	2.437	0.375	44	62	10
24600-0131	26-L	11.750	13.250	0.625	298	337	16	24600-0904	26	1.750	2.500	0.375	44	64	10
24600-0233	26-L	14.375	16.000	0.688	365	406	17	24600-0913	26	1.378	3.465	0.500	35	88	13
24600-0287	26	1.000	1.500	0.313	25	38	8	24600-0914	26	3.125	4.250	0.500	79	108	13
24600-0303	26	1.000	2.062	0.375	25	52	10	24600-0933	26	4.250	5.375	0.500	108	137	13
24600-0351	26	1.125	1.625	0.313	29	41	8	24600-0973	26	1.813	2.500	0.375	46	64	10
24600-0353	26	1.125	1.750	0.375	29	44	10	24600-0976	26	1.812	2.625	0.375	46	67	10
24600-0378	26	1.181	1.969	0.276	30	50	7	24600-0978	26	4.000	5.000	0.375	102	127	10
24600-0383	26	1.188	1.875	0.375	30	48	10	24600-0983	26-L	18.000	20.000	0.625	457	508	16
24600-0441	26-L	24.438	26.438	0.750	621	672	19	24600-0985	26-L	12.000	13.750	0.688	305	349	17
24600-0532	26-L	33.500	36.000	0.875	851	914	22	24600-0992	26-L	14.173	15.354	0.709	360	390	18
24600-0547	26	1.375	2.375	0.375	35	60	10	24600-0994	26	4.724	5.708	0.433	120	145	11
24600-0549	26-L	35.500	37.500	0.875	902	953	22	24600-1007	26-L	15.000	17.500	1.250	381	445	32
24600-0556	26	1.375	2.500	0.375	35	64	10	24600-1039	26	1.875	2.750	0.500	48	70	13
24600-0575	26	1.378	2.244	0.394	35	57	10	24600-1040	26-L	10.826	12.000	0.590	275	305	15
24600-0598	26	1.438	2.375	0.375	37	60	10	24600-1060	26	6.494	7.525	0.516	165	191	13
24600-0609	26	1.437	2.500	0.500	36	64	13	24600-1063	26	1.875	3.000	0.375	48	76	10
24600-0622	26	1.875	2.875	0.313	48	73	8	24600-1067	26	1.875	3.543	0.375	48	90	10
24600-0631	26	1.250	2.250	0.500	32	57	13	24600-1068	26-L	8.250	10.250	0.750	210	260	19
24600-0634	26	1.438	2.438	0.500	37	62	13	24600-1096	26	1.653	2.441	0.315	42	62	8
24600-0635	26	1.500	2.500	0.500	38	64	13	24600-1097	26	1.772	2.441	0.394	45	62	10
24600-0639	26	1.750	2.750	0.500	44	70	13	24600-1103	26	1.969	3.150	0.315	50	80	8
24600-0643	26	1.500	2.250	0.375	38	57	10	24600-1104	26	1.969	2.756	0.394	50	70	10
24600-0644	26	1.500	2.250	0.438	38	57	11	24600-1111	26	1.938	2.500	0.375	49	64	10
24600-0672	26	5.750	6.750	0.500	146	171	13	24600-1114	26	1.937	2.625	0.375	49	67	10
24600-0674	26	5.875	6.875	0.500	149	175	13	24600-1125	26	1.938	3.000	0.438	49	76	11
24600-0698	26	1.563	2.189	0.313	40	56	8	24600-1126	26	1.938	3.188	0.469	49	81	12
24600-0705	26	1.375	2.064	0.500	35	52	13	24600-1130	26	1.938	2.875	0.438	49	73	11
24600-0708	26	1.375	2.439	0.500	35	62	13	24600-1137	26	1.938	3.000	0.500	49	76	13
24600-0733	26	1.575	2.362	0.354	40	60	9	24600-1139	26	1.378	2.047	0.276	35	52	7
24600-0737	26	1.438	2.125	0.375	37	54	10	24600-1149	26	1.938	3.188	0.500	49	81	13
24600-0741	26	1.438	2.250	0.500	37	57	13	24600-1155	26	1.962	3.188	0.469	50	81	12
24600-0754	26	1.375	2.500	0.625	35	64	16	24600-1173	26	2.000	2.715	0.438	51	69	11
24600-0758	26	1.625	2.188	0.375	41	56	10	24600-1182	26	2.000	3.375	0.375	51	86	10
24600-0760	26	1.625	2.375	0.375	41	60	10	24600-1190	26	2.000	2.750	0.438	51	70	11
24600-0784	26	0.875	1.500	0.375	22	38	10	24600-1191	26	2.000	2.750	0.500	51	70	13
24600-0785	26	0.938	1.500	0.375	24	38	10	24600-1195	26	2.000	2.783	0.375	51	71	10
24600-0791	26	1.654	2.165	0.394	42	55	10	24600-1198	26	2.000	2.875	0.375	51	73	10
24600-0800	26-L	10.000	12.000	1.000	254	305	25	24600-1204	26	2.000	3.000	0.375	51	76	10
24600-0809	26-L	9.000	10.500	0.500	229	267	13	24600-1206	26	2.000	3.000	0.500	51	76	13
24600-0814	26	1.125	2.062	0.375	29	52	10	24600-1217	26	2.000	3.188	0.438	51	81	11
24600-0817	26	2.125	3.192	0.500	54	81	13	24600-1224	26	2.062	2.875	0.468	52	73	12
24600-0827	26	2.953	3.937	0.512	75	100	13	24600-1228	26	1.575	2.559	0.276	40	65	7
24600-0828	26-L	9.448	12.598	0.984	240	320	25	24600-1234	26	1.563	2.250	0.375	40	57	10
24600-0829	26	2.519	3.464	0.472	64	88	12	24600-1258	26	2.062	3.000	0.375	52	76	10
24600-0831	26-L	37.000	39.250	0.875	940	997	22	24600-1259	26	5.935	6.963	0.516	151	177	13
24600-0833	26	1.687	2.561	0.500	43	65	13	24600-1260	26	2.062	3.000	0.500	52	76	13
24600-0834	26	1.688	2.502	0.375	43	64	10	24600-1261	26	2.062	3.062	0.375	52	78	10
24600-0835	26	1.688	2.500	0.375	43	64	10	24600-1275	26	0.875	1.375	0.375	22	35	10

All dimensions are in inches. Preferred sizes are indicated with **bold** type face.

Sizes listed are for standard nitrile elements, except Models 25 and 62 which have PTFE elements. Other material available on inquiry only.

## Oil Seals by Model Number

Product Code	Model	Inches			MM			Product Code	Model	Inches			MM		
		ID	OD	Width	ID	OD	Width			ID	OD	Width	ID	OD	Width
24600-1276	26	0.875	1.828	0.438	22	46	11	24600-1668	26	2.375	3.500	0.500	60	89	13
24600-1277	26	0.875	1.625	0.375	22	41	10	24600-1685	26	2.440	3.250	0.500	62	83	13
24600-1282	26	0.969	2.000	0.375	25	51	10	24600-1686	26	2.500	3.125	0.313	64	79	8
24600-1283	26	1.000	1.750	0.375	25	44	10	24600-1697	26	4.438	5.750	0.563	113	146	14
24600-1285	26	1.062	1.625	0.375	27	41	10	24600-1714	26	7.313	8.438	0.563	186	214	14
24600-1288	26	1.125	1.828	0.375	29	46	10	24600-1716	26	7.441	9.875	0.512	189	251	13
24600-1289	26	1.125	1.984	0.437	29	50	11	24600-1746	26	2.438	3.481	0.500	62	88	13
24600-1290	26	1.125	2.844	0.500	29	72	13	24600-1749	26	2.438	3.500	0.500	62	89	13
24600-1295	26	1.250	2.125	0.375	32	54	10	24600-1757	26	2.489	3.250	0.312	63	83	8
24600-1296	26	1.250	2.438	0.438	32	62	11	24600-1767	26	1.750	2.750	0.375	44	70	10
24600-1298	26	1.375	2.688	0.500	35	68	13	24600-1775	26	8.000	8.875	0.437	203	225	11
24600-1301	26	1.625	2.438	0.375	41	62	10	24600-1787	26	2.500	3.350	0.250	64	85	6
24600-1302	26	1.625	2.687	0.500	41	68	13	24600-1798	26	2.559	3.346	0.394	65	85	10
24600-1304	26	1.688	2.375	0.375	43	60	10	24600-1801	26	2.500	3.188	0.375	64	81	10
24600-1305	26	1.688	2.750	0.438	43	70	11	24600-1820	26	2.500	3.500	0.437	64	89	11
24600-1319	26	2.125	2.833	0.438	54	72	11	24600-1821	26	2.500	3.500	0.500	64	89	13
24600-1320	26	2.125	2.875	0.438	54	73	11	24600-1826	26	2.500	3.623	0.437	64	92	11
24600-1321	26	2.125	2.875	0.375	54	73	10	24600-1828	26	2.500	3.750	0.375	64	95	10
24600-1325	26	2.125	3.000	0.500	54	76	13	24600-1829	26	1.375	2.125	0.375	35	54	10
24600-1331	26-L	16.535	18.504	0.866	420	470	22	24600-1838	26	2.625	3.375	0.437	67	86	11
24600-1332	26-L	15.748	17.480	0.787	400	444	20	24600-1842	26	2.625	3.625	0.438	67	92	11
24600-1333	26	2.125	3.125	0.375	54	79	10	24600-1848	26	2.688	3.875	0.468	68	98	12
24600-1334	26	2.125	3.125	0.438	54	79	11	24600-1855	26	4.724	5.512	0.512	120	140	13
24600-1345	26	2.125	3.250	0.375	54	83	10	24600-1907	26	3.937	4.921	0.256	100	125	7
24600-1355	26	2.125	3.545	0.438	54	90	11	24600-1913	26	8.500	9.750	0.750	216	248	19
24600-1375	26	3.375	4.355	0.375	86	111	10	24600-1914	26-L	8.875	10.125	0.750	225	257	19
24600-1394	26	1.125	1.875	0.375	29	48	10	24600-1922	26-L	9.750	11.125	0.750	248	283	19
24600-1404	26	2.188	3.000	0.500	56	76	13	24600-1939	26	2.625	3.500	0.375	67	89	10
24600-1408	26	2.188	3.125	0.375	56	79	10	24600-1950	26	2.625	3.750	0.500	67	95	13
24600-1427	26	2.188	3.350	0.469	56	85	12	24600-1968	26	3.537	4.500	0.500	90	114	13
24600-1431	26	1.187	2.250	0.500	30	57	13	24600-1987	26	2.688	3.372	0.375	68	86	10
24600-1432	26	1.188	2.360	0.250	30	60	6	24600-2004	26	2.688	3.750	0.500	68	95	13
24600-1454	26	1.375	2.000	0.313	35	51	8	24600-2020	26	2.750	3.375	0.313	70	86	8
24600-1465	26	1.438	2.000	0.313	37	51	8	24600-2021	26	2.750	4.625	0.625	70	117	16
24600-1466	26	1.438	2.063	0.313	37	52	8	24600-2033	26	2.750	3.751	0.687	70	95	17
24600-1469	26	2.250	2.875	0.313	57	73	8	24600-2035	26	2.750	3.500	0.375	70	89	10
24600-1474	26	2.250	3.000	0.375	57	76	10	24600-2037	26	2.750	3.500	0.500	70	89	13
24600-1482	26	2.250	3.125	0.500	57	79	13	24600-2039	26	2.750	3.543	0.438	70	90	11
24600-1492	26	2.250	3.250	0.375	57	83	10	24600-2041	26-L	9.449	11.024	0.591	240	280	15
24600-1504	26	2.250	3.500	0.375	57	89	10	24600-2044	26-L	9.469	10.625	0.625	241	270	16
24600-1508	26	2.250	3.353	0.375	57	85	10	24600-2047	26	5.315	6.614	0.709	135	168	18
24600-1509	26	2.250	3.375	0.500	57	86	13	24600-2054	26	2.750	3.625	0.438	70	92	11
24600-1511	26	2.250	3.750	0.500	57	95	13	24600-2058	26	2.750	3.750	0.438	70	95	11
24600-1561	26	2.313	3.125	0.375	59	79	10	24600-2065	26	2.750	4.003	0.469	70	102	12
24600-1565	26	2.662	3.071	0.394	68	78	10	24600-2068	26	2.750	4.125	0.438	70	105	11
24600-1568	26	2.363	3.127	0.375	60	79	10	24600-2070	26	2.756	3.543	0.394	70	90	10
24600-1572	26	2.375	3.188	0.438	60	81	11	24600-2071	26	2.756	3.543	0.237	70	90	6
24600-1579	26	1.772	2.622	0.500	45	67	13	24600-2077	26	2.795	3.465	0.472	71	88	12
24600-1580	26	2.375	3.250	0.328	60	83	8	24600-2081	26	2.938	4.008	0.469	75	102	12
24600-1602	26	2.344	3.125	0.500	60	79	13	24600-2098	26	5.512	7.087	0.630	140	180	16
24600-1621	26	2.438	3.547	0.500	62	90	13	24600-2105	26	2.953	4.213	0.492	75	107	13
24600-1623	26	2.499	3.542	0.500	63	90	13	24600-2111	26	3.225	3.975	0.375	82	101	10
24600-1627	26	2.563	3.500	0.375	65	89	10	24600-2113	26	2.875	4.000	0.469	73	102	12
24600-1639	26	2.375	3.062	0.500	60	78	13	24600-2114	26	2.875	3.500	0.313	73	89	8
24600-1642	26	2.375	3.125	0.375	60	79	10	24600-2120	26	2.875	3.751	0.500	73	95	13
24600-1652	26	2.375	3.375	0.500	60	86	13	24600-2121	26	2.875	3.875	0.375	73	98	10

All dimensions are in inches. Preferred sizes are indicated with **bold** type face. Sizes listed are for standard nitrile elements, except Models 25 and 62 which have PTFE elements. Other material available on inquiry only.



## Oil Seals by Model Number

Product Code	Model	Inches			MM			Product Code	Model	Inches			MM		
		ID	OD	Width	ID	OD	Width			ID	OD	Width	ID	OD	Width
24600-2128	26	1.250	2.000	0.375	32	51	10	24600-2511	26-L	19.983	21.125	0.625	508	537	16
24600-2137	26	2.901	3.601	0.232	74	91	6	24600-2513	26	3.875	5.375	0.500	98	137	13
24600-2144	26	2.938	3.625	0.375	75	92	10	24600-2514	26	3.875	5.000	0.469	98	127	12
24600-2145	26	7.402	8.583	0.591	188	218	15	24600-2525	26	3.937	5.250	0.500	100	133	13
24600-2146	26	2.938	3.750	0.375	75	95	10	24600-2546	26	4.000	5.375	0.500	102	137	13
24600-2147	26	8.189	9.370	0.591	208	238	15	24600-2555	26	4.000	5.750	0.500	102	146	13
24600-2148	26-L	10.787	11.969	0.591	274	304	15	24600-2562	26	3.307	4.331	0.551	84	110	14
24600-2149	26-L	9.528	10.709	0.591	242	272	15	24600-2580	26-L	13.250	14.750	0.688	337	375	17
24600-2151	26	2.938	3.875	0.500	75	98	13	24600-2590	26	4.000	4.875	0.563	102	124	14
24600-2168	26	3.000	3.750	0.375	76	95	10	24600-2591	26	4.000	4.875	0.625	102	124	16
24600-2171	26	3.000	3.876	0.375	76	98	10	24600-2592	26	4.000	5.000	0.469	102	127	12
24600-2174	26	3.000	4.003	0.375	76	102	10	24600-2593	26	4.000	5.000	0.625	102	127	16
24600-2180	26	3.000	4.250	0.500	76	108	13	24600-2595	26	4.000	5.250	0.468	102	133	12
24600-2186	26	3.000	4.500	0.500	76	114	13	24600-2600	26	4.125	5.125	0.500	105	130	13
24600-2187	26	3.000	4.125	0.438	76	105	11	24600-2601	26	4.063	5.500	0.563	103	140	14
24600-2198	26	3.000	5.000	0.500	76	127	13	24600-2603	26	4.125	5.250	0.500	105	133	13
24600-2214	26	3.346	4.331	0.472	85	110	12	24600-2612	26	4.125	5.625	0.500	105	143	13
24600-2215	26	3.150	4.134	0.512	80	105	13	24600-2621	26	1.969	4.331	0.375	50	110	10
24600-2218	26	3.188	4.340	0.305	81	110	8	24600-2644	26	4.188	5.250	0.468	106	133	12
24600-2225	26	3.125	4.125	0.500	79	105	13	24600-2646	26	4.188	5.250	0.625	106	133	16
24600-2237	26	3.125	4.625	0.500	79	117	13	24600-2653	26	4.250	5.000	0.438	108	127	11
24600-2238	26	3.150	3.938	0.512	80	100	13	24600-2657	26	4.250	5.250	0.500	108	133	13
24600-2243	26	3.150	4.330	0.237	80	110	6	24600-2664	26	4.250	5.500	0.563	108	140	14
24600-2262	26	3.250	4.000	0.250	83	102	6	24600-2686	26	4.331	5.118	0.512	110	130	13
24600-2265	26	3.250	4.000	0.438	83	102	11	24600-2712	26	4.375	5.500	0.562	111	140	14
24600-2267	26	3.188	5.000	0.500	81	127	13	24600-2731	26	4.331	5.512	0.512	110	140	13
24600-2269	26	3.250	4.125	0.563	83	105	14	24600-2732	26	4.438	5.500	0.500	113	140	13
24600-2274	26	2.756	4.331	0.500	70	110	13	24600-2753	26	4.500	5.500	0.500	114	140	13
24600-2297	26	3.313	4.375	0.500	84	111	13	24600-2759	26	4.500	5.750	0.500	114	146	13
24600-2305	26	3.312	5.000	0.468	84	127	12	24600-2761	26	4.500	5.750	0.625	114	146	16
24600-2310	26	3.346	4.134	0.512	85	105	13	24600-2763	26	4.500	5.250	0.375	114	133	10
24600-2319	26	3.375	5.000	0.469	86	127	12	24600-2765	26	4.500	6.000	0.500	114	152	13
24600-2321	26	3.375	4.375	0.500	86	111	13	24600-2788	26	4.562	5.750	0.562	116	146	14
24600-2324	26	3.375	4.500	0.500	86	114	13	24600-2798	26	4.625	5.625	0.500	117	143	13
24600-2345	26	3.437	4.500	0.500	87	114	13	24600-2802	26	4.625	5.750	0.563	117	146	14
24600-2348	26	3.438	4.625	0.500	87	117	13	24600-2820	26	4.688	5.750	0.500	119	146	13
24600-2356	26	3.438	4.875	0.625	87	124	16	24600-2822	26-L	20.500	21.500	0.469	521	546	12
24600-2364	26	3.500	4.375	0.375	89	111	10	24600-2837	26	4.750	5.750	0.500	121	146	13
24600-2366	26	3.500	4.500	0.500	89	114	13	24600-2840	26	4.750	5.875	0.500	121	149	13
24600-2368	26	3.500	4.500	0.625	89	114	16	24600-2841	26	4.750	5.500	0.375	121	140	10
24600-2377	26	3.500	4.500	0.438	89	114	11	24600-2845	26	4.750	6.000	0.625	121	152	16
24600-2412	26	3.625	4.750	0.625	92	121	16	24600-2851	26	4.750	6.250	0.625	121	159	16
24600-2417	26	3.625	4.625	0.500	92	117	13	24600-2853	26	4.750	6.500	0.625	121	165	16
24600-2432	26	3.625	5.250	0.500	92	133	13	24600-2873	26-L	39.370	41.339	0.906	1000	1050	23
24600-2441	26	3.688	4.750	0.500	94	121	13	24600-2875	26	4.875	6.000	0.625	124	152	16
24600-2447	26	3.688	4.999	0.500	94	127	13	24600-2879	26	4.875	6.250	0.500	124	159	13
24600-2450	26	1.500	2.375	0.375	38	60	10	24600-2881	26	4.875	6.250	0.625	124	159	16
24600-2456	26	1.750	2.625	0.312	44	67	8	24600-2886	26	4.875	6.250	0.858	124	159	22
24600-2457	26	3.543	4.724	0.511	90	120	13	24600-2889	26	4.921	6.299	0.591	125	160	15
24600-2462	26	3.750	4.750	0.500	95	121	13	24600-2900	26	4.938	6.250	0.500	125	159	13
24600-2477	26	3.750	5.000	0.438	95	127	11	24600-2913	26	4.987	6.000	0.500	127	152	13
24600-2478	26	3.750	5.000	0.500	95	127	13	24600-2915	26	5.000	6.000	0.500	127	152	13
24600-2498	26	3.812	5.500	0.500	97	140	13	24600-2921	26	5.000	6.250	0.500	127	159	13
24600-2501	26-L	22.598	23.779	0.590	574	604	15	24600-2922	26	5.000	6.250	0.562	127	159	14
24600-2504	26-L	19.685	20.866	0.590	500	530	15	24600-2923	26	5.000	6.250	0.625	127	159	16
24600-2505	26-L	24.567	25.748	0.590	624	654	15	24600-2928	26	5.000	6.500	0.563	127	165	14

All dimensions are in inches. Preferred sizes are indicated with **bold** type face.

Sizes listed are for standard nitrile elements, except Models 25 and 62 which have PTFE elements. Other material available on inquiry only.

## Oil Seals by Model Number

Product Code	Model	Inches			MM			Product Code	Model	Inches			MM		
		ID	OD	Width	ID	OD	Width			ID	OD	Width	ID	OD	Width
24600-2932	26	5.000	5.750	0.437	127	146	11	24600-3460	26	6.750	8.000	0.625	171	203	16
24600-2940	26	6.679	7.406	0.250	170	188	6	24600-3461	26-L	22.047	24.016	0.787	560	610	20
24600-2988	26	5.118	6.299	0.591	130	160	15	24600-3486	26	6.875	8.384	0.625	175	213	16
24600-2990	26	5.125	6.125	0.500	130	156	13	24600-3492	26	7.000	8.000	0.625	178	203	16
24600-2998	26	5.125	6.375	0.625	130	162	16	24600-3494	26	7.000	8.125	0.625	178	206	16
24600-3019	26	5.500	6.375	0.563	140	162	14	24600-3500	26	7.000	8.500	0.625	178	216	16
24600-3026	26	5.188	6.250	0.500	132	159	13	24600-3511	26	6.938	8.000	0.625	176	203	16
24600-3037	26	3.688	4.750	0.438	94	121	11	24600-3512	26	7.125	8.500	0.625	181	216	16
24600-3050	26-L	15.000	17.500	0.938	381	445	24	24600-3522	26	7.250	8.500	0.625	184	216	16
24600-3055	26-L	17.250	19.250	0.875	438	489	22	24600-3544	26	7.500	8.500	0.625	191	216	16
24600-3059	26	5.250	6.250	0.500	133	159	13	24600-3552	26	7.500	9.000	0.625	191	229	16
24600-3067	26	5.250	6.500	0.625	133	165	16	24600-3553	26	7.500	9.000	0.750	191	229	19
24600-3122	26	5.375	6.375	0.500	137	162	13	24600-3566	26	7.625	9.125	0.625	194	232	16
24600-3124	26	5.375	6.750	0.625	137	171	16	24600-3578	26	7.750	9.250	0.625	197	235	16
24600-3135	26	6.625	8.750	0.500	168	222	13	24600-3583	26	5.063	6.125	0.500	129	156	13
24600-3136	26-L	7.500	10.250	0.500	191	260	13	24600-3587	26	2.165	3.150	0.394	55	80	10
24600-3173	26	5.438	6.625	0.500	138	168	13	24600-3589	26	7.875	9.375	0.750	200	238	19
24600-3176	26	5.500	6.500	0.500	140	165	13	24600-3592	26	8.000	9.000	0.625	203	229	16
24600-3177	26	5.500	6.250	0.438	140	159	11	24600-3594	26	8.000	9.125	0.625	203	232	16
24600-3182	26	5.500	6.750	0.500	140	171	13	24600-3598	26	8.000	9.375	0.625	203	238	16
24600-3183	26	5.500	6.750	0.563	140	171	14	24600-3606	26	8.250	9.500	0.625	210	241	16
24600-3184	26	5.500	6.750	0.625	140	171	16	24600-3611	26-L	8.625	10.625	0.750	219	270	19
24600-3189	26	5.500	7.000	0.750	140	178	19	24600-3619	26-L	9.000	10.500	0.750	229	267	19
24600-3194	26	5.500	7.250	0.500	140	184	13	24600-3623	26-L	9.000	11.000	0.750	229	279	19
24600-3203	26	5.512	6.693	0.295	140	170	7	24600-3633	26-L	9.250	11.250	1.000	235	286	25
24600-3204	26	5.512	6.890	0.709	140	175	18	24600-3635	26-L	16.688	18.031	0.750	424	458	19
24600-3216	26	2.500	3.228	0.315	64	82	8	24600-3637	26-L	34.016	36.535	0.984	864	928	25
24600-3236	26	5.625	6.875	0.625	143	175	16	24600-3640	26-L	9.500	10.750	0.625	241	273	16
24600-3260	26	4.331	5.118	0.354	110	130	9	24600-3644	26-L	9.500	11.250	0.625	241	286	16
24600-3277	26	5.750	6.750	0.625	146	171	16	24600-3648	26-L	9.500	11.500	1.000	241	292	25
24600-3281	26	5.750	7.000	0.500	146	178	13	24600-3654	26-L	9.750	11.250	0.750	248	286	19
24600-3283	26	5.750	7.000	0.625	146	178	16	24600-3655	26-L	9.750	11.750	1.000	248	298	25
24600-3287	26	5.750	6.950	0.305	146	177	8	24600-3663	26	2.953	3.740	0.511	75	95	13
24600-3300	26	2.313	3.062	0.375	59	78	10	24600-3665	26-L	10.500	11.750	0.625	267	298	16
24600-3308	26	1.938	3.250	0.375	49	83	10	24600-3667	26-L	20.866	22.835	0.866	530	580	22
24600-3326	26	6.102	6.850	0.472	155	174	12	24600-3677	26-L	10.250	12.250	1.000	260	311	25
24600-3329	26	6.693	8.268	0.630	170	210	16	24600-3680	26-L	10.500	12.500	1.000	267	318	25
24600-3330	26	5.875	7.375	0.625	149	187	16	24600-3682	26-L	10.750	11.750	0.563	273	298	14
24600-3354	26	6.000	7.000	0.438	152	178	11	24600-3685	26-L	10.750	12.250	0.562	273	311	14
24600-3361	26	6.000	7.250	0.500	152	184	13	24600-3686	26-L	10.750	12.500	0.563	273	318	14
24600-3362	26	6.000	7.000	0.750	152	178	19	24600-3687	26-L	10.750	12.750	0.563	273	324	14
24600-3373	26	6.000	7.625	0.625	152	194	16	24600-3691	26-L	11.000	12.000	0.625	279	305	16
24600-3377	26	6.125	7.125	0.625	156	181	16	24600-3695	26-L	11.024	12.598	0.787	280	320	20
24600-3379	26	6.000	7.500	0.375	152	191	10	24600-3720	26-L	11.000	12.250	0.688	279	311	17
24600-3389	26	6.000	7.508	0.625	152	191	16	24600-3721	26-L	12.598	14.331	0.787	320	364	20
24600-3390	26	6.188	7.688	0.750	157	195	19	24600-3722	26-L	10.827	12.205	0.591	275	310	15
24600-3404	26	6.300	7.480	0.295	160	190	7	24600-3726	26-L	14.000	16.250	1.000	356	413	25
24600-3415	26	3.188	4.500	0.500	81	114	13	24600-3742	26-L	18.000	20.000	1.000	457	508	25
24600-3418	26	6.125	7.625	0.625	156	194	16	24600-3758	26	7.480	9.250	0.630	190	235	16
24600-3423	26	6.375	7.875	0.625	162	200	16	24600-3793	26-L	17.000	18.250	0.625	432	464	16
24600-3424	26	6.437	7.687	0.625	163	195	16	24600-3811	26	7.875	9.000	0.438	200	229	11
24600-3430	26	6.500	7.750	0.625	165	197	16	24600-3817	26	8.250	9.250	0.625	210	235	16
24600-3435	26	6.500	8.000	0.750	165	203	19	24600-3825	26	8.625	9.625	0.500	219	244	13
24600-3438	26	6.625	7.725	0.305	168	196	8	24600-3828	26-L	8.625	10.500	0.500	219	267	13
24600-3451	26	6.693	7.874	0.295	170	200	7	24600-3829	26	8.750	9.750	0.563	222	248	14
24600-3452	26	7.000	8.000	0.437	178	203	11	24600-3832	26-L	8.875	10.125	0.625	225	257	16

All dimensions are in inches. Preferred sizes are indicated with **bold** type face. Sizes listed are for standard nitrile elements, except Models 25 and 62 which have PTFE elements. Other material available on inquiry only.

## Oil Seals by Model Number

Product Code	Model	Inches			MM			Product Code	Model	Inches			MM		
		ID	OD	Width	ID	OD	Width			ID	OD	Width	ID	OD	Width
24600-3833	26-L	8.875	10.875	1.000	225	276	25	24600-4269	26-L	22.000	23.500	0.750	559	597	19
24600-3834	26-L	9.000	10.000	0.469	229	254	12	24600-4294	26-L	24.000	26.000	0.875	610	660	22
24600-3840	26-L	9.250	10.750	0.656	235	273	17	24600-4345	26-L	9.844	11.024	0.650	250	280	17
24600-3841	26-L	9.500	10.500	0.438	241	267	11	24600-4388	26	6.188	7.508	0.250	157	191	6
24600-3842	26-L	9.500	11.000	0.688	241	279	17	24600-4393	26-L	17.323	18.898	0.787	440	480	20
24600-3850	26-L	11.500	12.500	0.500	292	318	13	24600-4394	26-L	14.173	15.748	0.709	360	400	18
24600-3853	26-L	12.000	14.000	0.625	305	356	16	24600-4395	26	5.906	7.480	0.591	150	190	15
24600-3867	26-L	15.551	17.283	0.866	395	439	22	24600-4396	26-L	15.748	17.323	0.787	400	440	20
24600-3868	26-L	16.500	17.750	0.750	419	451	19	24600-4397	26-L	12.598	14.173	0.787	320	360	20
24600-3882	26-L	13.386	14.961	0.709	340	380	18	24600-4405	26-L	34.500	36.500	0.875	876	927	22
24600-3885	26	1.125	2.750	0.375	29	70	10	24600-4406	26	4.500	5.750	0.438	114	146	11
24600-3891	26-L	14.250	16.250	0.625	362	413	16	24600-4486	26-L	18.110	20.079	0.866	460	510	22
24600-3908	26	7.875	9.252	0.630	200	235	16	24600-4496	26-L	12.500	14.000	0.625	318	356	16
24600-3910	26-L	9.449	10.828	0.630	240	275	16	24600-4515	26-L	9.750	11.000	0.625	248	279	16
24600-3913	26	6.300	7.481	0.630	160	190	16	24600-4530	26-L	13.750	15.250	0.750	349	387	19
24600-3914	26	7.874	9.055	0.551	200	230	14	24600-4557	26	3.000	4.000	0.500	76	102	13
24600-3916	26	7.874	9.449	0.787	200	240	20	24600-4558	26	4.921	5.906	0.512	125	150	13
24600-3919	26	6.693	7.874	0.630	170	200	16	24600-4582	26	2.000	2.625	0.313	51	67	8
24600-3920	26	7.087	8.268	0.630	180	210	16	24600-4612	26-L	12.000	13.500	0.688	305	343	17
24600-3933	26	8.375	9.875	0.688	213	251	17	24600-4614	26	4.500	5.500	0.375	114	140	10
24600-3935	26	8.500	9.500	0.625	216	241	16	24600-4632	26	1.574	2.448	0.314	40	62	8
24600-3937	26-L	8.500	10.000	0.750	216	254	19	24600-4633	26	1.771	2.568	0.398	45	65	10
24600-3942	26	8.661	9.843	0.630	220	250	16	24600-4634	26	3.938	4.734	0.511	100	120	13
24600-3944	26-L	8.661	10.236	0.866	220	260	22	24600-4635	26	4.330	5.127	0.511	110	130	13
24600-3951	26-L	8.750	10.750	0.750	222	273	19	24600-4645	26	4.000	5.250	0.313	102	133	8
24600-3955	26-L	9.055	10.236	0.591	230	260	15	24600-4651	26	4.000	5.000	0.500	102	127	13
24600-3956	26-L	9.055	10.591	0.866	230	269	22	24600-4657	26	0.875	1.875	0.312	22	48	8
24600-3973	26-L	9.449	11.024	0.748	240	280	19	24600-4710	26	3.435	5.000	0.500	87	127	13
24600-3981	26	3.500	4.438	0.313	89	113	8	24600-4803	26-L	9.125	10.375	0.625	232	264	16
24600-3988	26	2.500	4.003	0.375	64	102	10	24600-4817	26	3.938	4.938	0.500	100	125	13
24600-3993	26	1.531	2.500	0.438	39	64	11	24600-4856	26-L	19.291	21.260	0.866	490	540	22
24600-3994	26-L	10.000	11.750	0.750	254	298	19	24600-4873	26	4.500	5.500	0.437	114	140	11
24600-4003	26-L	10.125	12.000	0.750	257	305	19	24600-4927	26-L	10.000	11.000	0.375	254	279	10
24600-4005	26-L	10.250	11.750	0.750	260	298	19	24600-4941	26-L	15.354	16.929	0.787	390	430	20
24600-4015	26-L	16.142	18.110	0.866	410	460	22	24600-4977	26-L	17.000	19.000	0.625	432	483	16
24600-4019	26-L	22.047	24.016	0.866	560	610	22	24600-4997	26	7.480	8.465	0.630	190	215	16
24600-4041	26-L	12.250	13.750	0.625	311	349	16	24600-5002	26	3.543	4.330	0.500	90	110	13
24600-4044	26	1.772	2.559	0.394	45	65	10	24600-5077	26-L	16.000	18.000	0.875	406	457	22
24600-4056	26-L	11.811	13.543	0.787	300	344	20	24600-5102	26-L	13.780	15.512	0.787	350	394	20
24600-4068	26-L	12.000	13.625	0.750	305	346	19	24600-5111	26-L	10.236	11.417	0.630	260	290	16
24600-4074	26-L	12.250	13.750	0.750	311	349	19	24600-5114	26-L	12.500	13.500	0.500	318	343	13
24600-4082	26-L	12.500	14.500	0.750	318	368	19	24600-5115	26	2.362	3.150	0.394	60	80	10
24600-4093	26-L	13.000	14.500	0.688	330	368	17	24600-5120	26-L	16.250	17.750	0.680	413	451	17
24600-4095	26-L	13.000	14.625	0.750	330	371	19	24600-5192	26	8.062	9.563	0.500	205	243	13
24600-4098	26-L	13.000	15.000	0.750	330	381	19	24600-5226	26	2.156	2.875	0.375	55	73	10
24600-4127	26-L	13.500	15.500	0.750	343	394	19	24600-5228	26-L	20.079	21.260	0.866	510	540	22
24600-4155	26-L	15.000	17.000	0.750	381	432	19	24600-5229	26-L	23.622	24.803	0.866	600	630	22
24600-4162	26-L	15.500	17.000	0.750	394	432	19	24600-5231	26	8.268	9.803	0.866	210	249	22
24600-4178	26-L	16.000	17.500	0.750	406	445	19	24600-5233	26-L	11.024	12.441	0.709	280	316	18
24600-4180	26-L	16.000	18.000	0.812	406	457	21	24600-5239	26	1.250	1.750	0.250	32	44	6
24600-4221	26-L	19.500	21.500	0.875	495	546	22	24600-5273	26	7.188	8.640	0.625	183	219	16
24600-4224	26	3.425	4.685	0.492	87	119	12	24600-5335	26	5.906	7.087	0.551	150	180	14
24600-4225	26	3.976	5.551	0.630	101	141	16	24600-5338	26	8.267	9.448	0.590	210	240	15
24600-4226	26	5.433	7.008	0.630	138	178	16	24600-5341	26-L	12.992	14.173	0.590	330	360	15
24600-4227	26	7.007	8.582	0.629	178	218	16	24600-5343	26	3.346	4.331	0.512	85	110	13
24600-4232	26-L	12.250	14.000	0.750	311	356	19	24600-5344	26	3.543	4.528	0.512	90	115	13

All dimensions are in inches. Preferred sizes are indicated with **bold** type face.

Sizes listed are for standard nitrile elements, except Models 25 and 62 which have PTFE elements. Other material available on inquiry only.

## Oil Seals by Model Number

Product Code	Model	Inches			MM			Product Code	Model	Inches			MM		
		ID	OD	Width	ID	OD	Width			ID	OD	Width	ID	OD	Width
24600-5345	26	3.937	4.921	0.512	100	125	13	24600-7281	26-L	18.898	20.472	0.787	480	520	20
24600-5348	26	4.724	5.906	0.551	120	150	14	24600-7288	26-L	10.433	11.683	0.625	265	297	16
24600-5351	26-L	10.236	11.417	0.590	260	290	15	24600-7374	26	3.250	4.250	0.500	83	108	13
24600-5353	26	4.134	5.315	0.551	105	135	14	24600-7618	26-L	18.250	20.250	0.812	464	514	21
24600-5359	26-L	9.449	10.630	0.591	240	270	15	24600-7682	26	3.125	4.250	0.625	79	108	16
24600-5422	26	5.118	6.299	0.472	130	160	12	24600-7801	26-L	15.250	16.750	0.750	387	425	19
24600-5429	26-L	10.236	11.811	0.787	260	300	20	24600-7832	26-L	11.250	12.750	0.625	286	324	16
24600-5439	26	4.750	5.625	0.437	121	143	11	24600-7836	26	4.724	6.299	0.472	120	160	12
24600-5445	26-L	10.629	11.811	0.630	270	300	16	24600-8233	26	3.250	4.249	0.375	83	108	10
24600-5454	26-L	32.969	34.625	0.750	837	879	19	24600-8313	26-L	9.625	10.875	0.625	244	276	16
24600-5456	26-L	13.500	15.000	0.653	343	381	17	24600-8592	26	3.875	4.875	0.438	98	124	11
24600-5457	26	5.250	6.000	0.375	133	152	10	24600-8814	26-L	12.283	13.750	0.688	312	349	17
24600-5483	26-L	12.312	13.937	0.750	313	354	19	24600-8815	26-L	14.016	15.000	0.688	356	381	17
24600-5484	26-L	13.937	15.437	0.750	354	392	19	24600-8830	26-L	10.787	12.250	0.688	274	311	17
24600-5491	26-L	21.882	23.732	0.866	556	603	22	24600-9175	26	5.315	6.693	0.512	135	170	13
24600-5492	26-L	21.654	23.622	0.925	550	600	23	24600-9646	26	3.937	5.062	0.375	100	129	10
24600-5493	26-L	20.276	21.850	0.787	515	555	20	24600-9662	26	4.000	5.000	0.438	102	127	11
24600-5495	26	4.750	5.625	0.625	121	143	16	24600-9722	26	1.500	2.250	0.250	38	57	6
24600-5500	26-L	15.551	16.929	0.709	395	430	18	24600-9780	26	6.500	7.500	0.563	165	191	14
24600-5598	26	2.756	4.015	0.500	70	102	13	24600-9960	26	4.250	5.250	0.438	108	133	11
24600-5637	26	3.875	4.750	0.375	98	121	10	24602-0055	26-L	9.500	11.500	0.625	241	292	16
24600-5844	26	1.875	2.623	0.313	48	67	8	24602-0287	26	1.000	1.500	0.313	25	38	8
24600-5913	26	3.938	5.000	0.500	100	127	13	24602-0338	26-L	18.500	20.000	0.750	470	508	19
24600-5918	26	1.575	2.047	0.276	40	52	7	24602-0598	26	1.438	2.375	0.375	37	60	10
24600-5919	26	7.087	7.874	0.591	180	200	15	24602-0656	26	3.813	4.813	0.500	97	122	13
24600-5924	26	3.937	6.693	0.394	100	170	10	24602-0708	26	1.375	2.439	0.500	35	62	13
24600-5942	26-L	12.756	14.252	0.748	324	362	19	24602-0775	26	4.134	5.315	0.472	105	135	12
24600-5963	26	2.559	3.031	0.354	65	77	9	24602-0778	26	3.250	4.250	0.469	83	108	12
24600-5964	26	2.559	3.031	0.276	65	77	7	24602-0800	26-L	10.000	12.000	1.000	254	305	25
24600-5987	26-L	14.563	16.000	0.625	370	406	16	24602-0811	26	4.250	5.500	0.625	108	140	16
24600-5989	26-L	12.992	14.567	0.787	330	370	20	24602-0980	26-L	25.500	28.000	1.000	648	711	25
24600-6042	26	6.000	7.125	0.625	152	181	16	24602-1033	26	3.150	3.938	0.394	80	100	10
24600-6170	26-L	9.843	11.417	0.641	250	290	16	24602-1130	26	1.938	2.875	0.438	49	73	11
24600-6175	26	7.250	8.250	0.438	184	210	11	24602-1187	26	1.969	2.835	0.315	50	72	8
24600-6177	26-L	25.984	28.504	0.984	660	724	25	24602-1189	26	1.378	2.047	0.276	35	52	7
24600-6182	26	7.375	8.375	0.437	187	213	11	24602-1192	26	2.480	3.189	0.394	63	81	10
24600-6185	26	7.750	8.750	0.437	197	222	11	24602-1201	26	2.000	2.997	0.375	51	76	10
24600-6207	26	1.375	1.875	0.250	35	48	6	24602-1469	26	2.250	2.875	0.313	57	73	8
24600-6372	26	6.750	7.750	0.500	171	197	13	24602-1668	26	2.375	3.500	0.500	60	89	13
24600-6384	26	8.500	9.750	0.625	216	248	16	24602-1775	26	8.000	8.875	0.437	203	225	11
24600-6386	26-L	8.750	10.000	0.625	222	254	16	24602-1820	26	2.500	3.500	0.438	64	89	11
24600-6395	26-L	11.000	13.000	0.750	279	330	19	24602-1842	26	2.625	3.625	0.437	67	92	11
24600-6450	26	6.250	7.250	0.438	159	184	11	24602-1892	26-L	14.173	15.748	0.787	360	400	20
24600-6471	26	2.750	3.750	0.500	70	95	13	24602-1972	26	2.000	2.750	0.375	51	70	10
24600-6570	26	8.625	9.875	0.625	219	251	16	24602-2002	26-L	18.386	20.079	0.787	467	510	20
24600-6808	26-L	10.000	11.250	0.625	254	286	16	24602-2034	26	4.331	5.119	0.473	110	130	12
24600-6839	26	3.250	4.250	0.438	83	108	11	24602-2036	26	5.512	6.693	0.472	140	170	12
24600-6867	26	6.229	7.549	0.625	158	192	16	24602-2070	26	2.756	3.543	0.394	70	90	10
24600-7033	26	0.750	1.250	0.250	19	32	6	24602-2082	26	2.953	3.937	0.394	75	100	10
24600-7059	26-L	18.500	20.500	0.750	470	521	19	24602-2102	26	2.875	3.563	0.309	73	91	8
24600-7101	26-L	8.500	10.500	0.750	216	267	19	24602-2168	26	3.000	3.750	0.375	76	95	10
24600-7209	26	2.165	3.938	0.375	55	100	10	24602-2174	26	3.000	4.003	0.375	76	102	10
24600-7213	26	3.125	3.875	0.375	79	98	10	24602-2188	26-L	26.181	28.701	0.984	665	729	25
24600-7263	26-L	11.500	12.750	0.625	292	324	16	24602-2238	26	3.150	3.938	0.512	80	100	13
24600-7267	26	5.512	6.693	0.591	140	170	15	24602-2321	26	3.375	4.375	0.500	86	111	13
24600-7276	26	6.299	7.480	0.591	160	190	15	24602-2366	26	3.500	4.500	0.500	89	114	13

All dimensions are in inches. Preferred sizes are indicated with **bold** type face.  
 Sizes listed are for standard nitrile elements, except Models 25 and 62 which have PTFE elements. Other material available on inquiry only.

## Oil Seals by Model Number

Product Code	Model	Inches			MM			Product Code	Model	Inches			MM		
		ID	OD	Width	ID	OD	Width			ID	OD	Width	ID	OD	Width
24602-2437	26	3.543	4.331	0.472	90	110	12	24602-6061	26	3.740	4.724	0.512	95	120	13
24602-2441	26	3.688	4.750	0.500	94	121	13	24602-6372	26	6.750	7.750	0.500	171	197	13
24602-2516	26	3.875	5.500	0.500	98	140	13	24602-6374	26	7.000	8.000	0.500	178	203	13
24602-2537	26	4.000	4.999	0.500	102	127	13	24602-6384	26	8.500	9.750	0.625	216	248	16
24602-2590	26	4.000	4.875	0.563	102	124	14	24602-6450	26	6.250	7.250	0.438	159	184	11
24602-2636	26	4.188	5.500	0.500	106	140	13	24602-7267	26	5.512	6.693	0.591	140	170	15
24602-2657	26	4.250	5.250	0.500	108	133	13	24602-7268	26	6.693	7.874	0.591	170	200	15
24602-2658	26	1.688	2.563	0.313	43	65	8	24602-7276	26	6.299	7.480	0.591	160	190	15
24602-2663	26	4.250	5.500	0.500	108	140	13	24602-7367	26	7.625	8.625	0.500	194	219	13
24602-2753	26	4.500	5.500	0.500	114	140	13	24602-7388	26	7.874	9.055	0.591	200	230	15
24602-2763	26	4.500	5.250	0.375	114	133	10	24602-7807	26	7.087	8.268	0.591	180	210	15
24602-2765	26	4.500	6.000	0.500	114	152	13	24602-7839	26	3.543	4.724	0.472	90	120	12
24602-2870	26	6.875	8.500	0.500	175	216	13	24602-8876	26	3.062	4.003	0.375	78	102	10
24602-2879	26	4.875	6.250	0.500	124	159	13	24602-9662	26	4.000	5.000	0.438	102	127	11
24602-2887	26	4.921	5.906	0.472	125	150	12	24602-9780	26	6.500	7.500	0.562	165	191	14
24602-2966	26	6.000	7.490	0.500	152	190	13	24605-4927	26-L	10.000	11.000	0.375	254	279	10
24602-2988	26	5.118	6.299	0.591	130	160	15	24605-5939	26-L	53.000	55.000	0.780	1346	1397	20
24602-2997	26	5.125	6.375	0.563	130	162	14	24608-5499	26	4.938	6.438	0.500	125	164	13
24602-3118	26	5.315	6.693	0.591	135	170	15	24608-5591	26	3.937	4.937	0.437	100	125	11
24602-3176	26	5.500	6.500	0.500	140	165	13	24609-1332	26-L	15.748	17.481	0.787	400	444	20
24602-3184	26	5.500	6.750	0.625	140	171	16	24609-4056	26-L	11.811	13.543	0.787	300	344	20
24602-3200	26	6.125	7.250	0.500	156	184	13	24610-0023	26-L	8.750	10.500	0.750	222	267	19
24602-3276	26	5.750	6.750	0.438	146	171	11	24610-0055	26-L	9.500	11.500	0.625	241	292	16
24602-3327	26	5.906	7.087	0.591	150	180	15	24610-0074	26-L	10.000	12.000	0.625	254	305	16
24602-3346	26	5.906	7.087	0.630	150	180	16	24610-0080	26-L	10.250	11.500	0.625	260	292	16
24602-3372	26	3.750	4.750	0.438	95	121	11	24610-0100	26-L	10.750	12.000	0.625	273	305	16
24602-3394	26	6.250	7.500	0.500	159	191	13	24610-0106	26-L	11.000	12.250	0.625	279	311	16
24602-3435	26	6.500	8.000	0.750	165	203	19	24610-0126	26-L	11.500	13.000	0.625	292	330	16
24602-3460	26	6.750	8.000	0.625	171	203	16	24610-0134	26-L	11.811	13.386	0.709	300	340	18
24602-3648	26-L	9.500	11.500	1.000	241	292	25	24610-0140	26-L	12.000	13.500	0.625	305	343	16
24602-3680	26-L	10.500	12.500	1.000	267	318	25	24610-0182	26-L	13.250	15.250	0.750	337	387	19
24602-3689	26-L	10.750	12.750	1.000	273	324	25	24610-0217	26-L	14.000	16.000	0.750	356	406	19
24602-3891	26-L	14.250	16.250	0.625	362	413	16	24610-0229	26-L	14.250	16.250	0.812	362	413	21
24602-3910	26-L	9.449	10.827	0.630	240	275	16	24610-0247	26-L	14.961	16.535	0.787	380	420	20
24602-3911	26	7.480	8.858	0.630	190	225	16	24610-0248	26-L	15.000	16.500	0.687	381	419	17
24602-3913	26	6.299	7.480	0.630	160	190	16	24610-0288	26	1.000	1.500	0.375	25	38	10
24602-3929	26	4.134	5.118	0.472	105	130	12	24610-0312	26-L	17.625	19.125	0.750	448	486	19
24602-3937	26-L	8.500	10.000	0.750	216	254	19	24610-0342	26	1.045	1.670	0.375	27	42	10
24602-3942	26	8.661	9.843	0.630	220	250	16	24610-0346	26-L	19.000	21.000	0.875	483	533	22
24602-4082	26-L	12.500	14.500	0.750	318	368	19	24610-0409	26-L	22.438	24.438	0.875	570	621	22
24602-4180	26-L	16.000	18.000	0.813	406	457	21	24610-0427	26-L	23.500	25.500	0.875	597	648	22
24602-4231	26-L	20.000	22.000	0.625	508	559	16	24610-0437	26-L	24.000	26.500	1.000	610	673	25
24602-4505	26-L	9.000	10.250	0.625	229	260	16	24610-0462	26-L	26.000	28.500	0.875	660	724	22
24602-4917	26-L	29.920	31.496	0.787	760	800	20	24610-0467	26-L	26.500	28.000	0.750	673	711	19
24602-5118	26	4.724	5.906	0.500	120	150	13	24610-0506	26-L	30.000	32.500	0.875	762	826	22
24602-5155	26	7.874	9.055	0.492	200	230	12	24610-0512	26-L	31.000	33.000	0.875	787	838	22
24602-5156	26	1.750	2.375	0.313	44	60	8	24610-0520	26-L	32.500	34.500	0.875	826	876	22
24602-5273	26	7.188	8.640	0.625	183	219	16	24610-0592	26	1.437	2.188	0.375	36	56	10
24602-5304	26	1.575	2.835	0.276	40	72	7	24610-0621	26-L	14.000	15.500	0.750	356	394	19
24602-5323	26	7.125	8.250	0.750	181	210	19	24610-0634	26	1.438	2.438	0.500	37	62	13
24602-5339	26-L	9.842	11.023	0.590	250	280	15	24610-0635	26	1.500	2.500	0.500	38	64	13
24602-5357	26	8.661	9.842	0.590	220	250	15	24610-0638	26	1.688	2.688	0.500	43	68	13
24602-5359	26-L	9.449	10.630	0.591	240	270	15	24610-0639	26	1.750	2.750	0.500	44	70	13
24602-5690	26	4.921	5.906	0.394	125	150	10	24610-0641	26	1.938	2.938	0.500	49	75	13
24602-5913	26	3.938	5.000	0.500	100	127	13	24610-0642	26	2.188	3.188	0.500	56	81	13
24602-5916	26	6.496	7.480	0.512	165	190	13	24610-0643	26	1.500	2.250	0.375	38	57	10

All dimensions are in inches. Preferred sizes are indicated with **bold** type face.

Sizes listed are for standard nitrile elements, except Models 25 and 62 which have PTFE elements. Other material available on inquiry only.

## Oil Seals by Model Number

Product Code	Model	Inches			MM			Product Code	Model	Inches			MM		
		ID	OD	Width	ID	OD	Width			ID	OD	Width	ID	OD	Width
24610-0644	26	1.500	2.250	0.437	38	57	11	24610-1321	26	2.125	2.875	0.375	54	73	10
24610-0645	26	2.437	3.437	0.500	62	87	13	24610-1333	26	2.125	3.125	0.375	54	79	10
24610-0647	26	2.687	3.687	0.500	68	94	13	24610-1334	26	2.125	3.125	0.438	54	79	11
24610-0648	26	2.812	3.812	0.500	71	97	13	24610-1335	26	2.125	3.125	0.500	54	79	13
24610-0651	26	3.188	4.188	0.500	81	106	13	24610-1360	26	2.166	2.844	0.313	55	72	8
24610-0655	26	3.688	4.688	0.500	94	119	13	24610-1394	26	1.125	1.875	0.375	29	48	10
24610-0658	26	4.063	5.063	0.500	103	129	13	24610-1468	26	1.437	2.188	0.375	36	56	10
24610-0665	26	4.938	5.938	0.500	125	151	13	24610-1474	26	2.250	3.000	0.375	57	76	10
24610-0669	26	5.438	6.437	0.500	138	163	13	24610-1492	26	2.250	3.250	0.375	57	83	10
24610-0678	26	6.250	7.250	0.500	159	184	13	24610-1494	26	2.250	3.250	0.500	57	83	13
24610-0682	26	6.500	7.500	0.500	165	191	13	24610-1553	26	2.313	3.251	0.438	59	83	11
24610-0718	26	3.500	4.375	0.500	89	111	13	24610-1563	26	2.312	3.125	0.500	59	79	13
24610-0755	26	4.188	5.250	0.500	106	133	13	24610-1566	26	2.362	3.149	0.393	60	80	10
24610-0760	26	1.625	2.375	0.375	41	60	10	24610-1642	26	2.375	3.125	0.375	60	79	10
24610-0788	26	1.500	2.375	0.500	38	60	13	24610-1652	26	2.375	3.375	0.500	60	86	13
24610-0800	26-L	10.000	12.000	1.000	254	305	25	24610-1683	26	2.438	3.531	0.500	62	90	13
24610-0801	26-L	9.250	10.750	0.750	235	273	19	24610-1721	26	7.750	9.000	0.625	197	229	16
24610-0807	26	2.250	3.250	0.437	57	83	11	24610-1767	26	1.750	2.750	0.375	44	70	10
24610-0811	26	4.250	5.500	0.625	108	140	16	24610-1770	26-L	25.750	26.875	0.500	654	683	13
24610-0813	26	3.375	4.125	0.375	86	105	10	24610-1801	26	2.500	3.189	0.375	64	81	10
24610-0827	26	2.952	3.938	0.511	75	100	13	24610-1808	26	2.500	3.250	0.437	64	83	11
24610-0893	26	2.500	3.625	0.500	64	92	13	24610-1809	26	2.500	3.250	0.500	64	83	13
24610-0902	26	2.750	4.000	0.500	70	102	13	24610-1812	26	2.500	3.500	0.500	64	89	13
24610-0904	26	1.750	2.500	0.375	44	64	10	24610-1820	26	2.500	3.500	0.437	64	89	11
24610-0914	26	3.125	4.250	0.500	79	108	13	24610-1821	26	2.500	3.500	0.500	64	89	13
24610-0920	26	3.500	4.750	0.500	89	121	13	24610-1826	26	2.500	3.625	0.437	64	92	11
24610-0922	26	3.500	5.000	0.500	89	127	13	24610-1827	26	2.500	3.625	0.500	64	92	13
24610-0927	26	3.750	5.250	0.500	95	133	13	24610-1828	26	2.500	3.750	0.375	64	95	10
24610-0928	26	3.875	5.000	0.500	98	127	13	24610-1829	26	1.375	2.125	0.375	35	54	10
24610-0940	26	4.625	5.750	0.500	117	146	13	24610-1842	26	2.625	3.625	0.438	67	92	11
24610-0941	26	4.625	5.875	0.500	117	149	13	24610-1844	26	2.625	3.625	0.500	67	92	13
24610-0952	26	5.125	6.375	0.500	130	162	13	24610-1853	26	6.300	7.480	0.630	160	190	16
24610-0978	26	4.000	5.000	0.375	102	127	10	24610-1892	26-L	14.173	15.748	0.787	360	400	20
24610-0993	26	4.000	5.125	0.563	102	130	14	24610-1897	26	1.438	2.375	0.500	37	60	13
24610-1006	26-L	30.000	32.000	0.875	762	813	22	24610-1913	26	8.500	9.750	0.750	216	248	19
24610-1013	26-L	20.000	21.500	0.750	508	546	19	24610-1928	26	1.968	2.968	0.375	50	75	10
24610-1021	26-L	15.250	17.250	0.813	387	438	21	24610-1957	26	2.625	3.750	0.400	67	95	10
24610-1024	26	6.000	7.500	0.625	152	191	16	24610-1963	26	5.512	7.087	0.590	140	180	15
24610-1037	26-L	11.811	13.583	0.866	300	345	22	24610-1966	26-L	12.598	14.173	0.709	320	360	18
24610-1042	26	1.875	2.625	0.375	48	67	10	24610-1972	26	2.000	2.750	0.375	51	70	10
24610-1068	26-L	8.250	10.250	0.750	210	260	19	24610-2006	26-L	13.500	15.000	0.750	343	381	19
24610-1097	26	1.772	2.441	0.394	45	62	10	24610-2035	26	2.750	3.500	0.375	70	89	10
24610-1120	26	1.937	2.750	0.375	49	70	10	24610-2043	26	7.481	8.662	0.591	190	220	15
24610-1135	26-L	22.000	24.000	0.875	559	610	22	24610-2057	26	2.750	3.750	0.375	70	95	10
24610-1137	26	1.937	3.000	0.500	49	76	13	24610-2070	26	2.756	3.543	0.394	70	90	10
24610-1189	26	2.000	2.750	0.375	51	70	10	24610-2118	26	2.875	3.751	0.375	73	95	10
24610-1196	26-L	10.866	11.866	0.625	276	301	16	24610-2121	26	2.875	3.875	0.375	73	98	10
24610-1200	26	2.000	2.875	0.500	51	73	13	24610-2167	26	2.938	4.000	0.500	75	102	13
24610-1204	26	2.000	3.000	0.375	51	76	10	24610-2168	26	3.000	3.750	0.375	76	95	10
24610-1206	26	2.000	3.000	0.500	51	76	13	24610-2170	26	6.125	7.125	0.562	156	181	14
24610-1244	26	1.500	2.250	0.375	38	57	10	24610-2174	26	3.000	4.003	0.375	76	102	10
24610-1258	26	2.062	3.000	0.375	52	76	10	24610-2177	26	3.000	4.125	0.500	76	105	13
24610-1279	26-L	9.000	10.000	0.438	229	254	11	24610-2185	26	7.000	8.375	0.625	178	213	16
24610-1283	26	1.000	1.750	0.375	25	44	10	24610-2186	26	3.000	4.500	0.500	76	114	13
24610-1292	26	1.188	1.938	0.375	30	49	10	24610-2199	26-L	33.000	35.000	0.875	838	889	22
24610-1320	26	2.125	2.875	0.438	54	73	11	24610-2212	26-L	10.236	11.811	0.630	260	300	16

All dimensions are in inches. Preferred sizes are indicated with **bold** type face. Sizes listed are for standard nitrile elements, except Models 25 and 62 which have PTFE elements. Other material available on inquiry only.

## Oil Seals by Model Number

Product Code	Model	Inches			MM			Product Code	Model	Inches			MM		
		ID	OD	Width	ID	OD	Width			ID	OD	Width	ID	OD	Width
24610-2213	26	3.563	4.625	0.500	91	117	13	24610-2797	26	4.625	5.375	0.375	117	137	10
24610-2225	26	3.125	4.125	0.500	79	105	13	24610-2798	26	4.625	5.625	0.500	117	143	13
24610-2233	26	6.625	8.125	0.625	168	206	16	24610-2800	26-L	16.000	18.000	1.000	406	457	25
24610-2238	26	3.150	3.937	0.512	80	100	13	24610-2801	26	2.625	3.375	0.375	67	86	10
24610-2242	26	3.150	3.937	0.394	80	100	10	24610-2820	26	4.688	5.750	0.500	119	146	13
24610-2263	26	3.250	4.000	0.375	83	102	10	24610-2837	26	4.750	5.750	0.500	121	146	13
24610-2283	26	3.740	4.528	0.500	95	115	13	24610-2890	26	4.921	6.693	0.472	125	170	12
24610-2297	26	3.313	4.375	0.500	84	111	13	24610-2906	26-L	11.500	13.000	0.750	292	330	19
24610-2315	26	2.000	3.000	0.438	51	76	11	24610-2914	26-L	9.750	10.750	0.625	248	273	16
24610-2321	26	3.375	4.375	0.500	86	111	13	24610-2915	26	5.000	6.000	0.500	127	152	13
24610-2338	26	6.000	7.250	0.625	152	184	16	24610-2916	26-L	10.500	12.000	0.750	267	305	19
24610-2345	26	3.437	4.500	0.500	87	114	13	24610-2921	26	5.000	6.250	0.500	127	159	13
24610-2364	26	3.500	4.375	0.375	89	111	10	24610-2922	26	5.000	6.250	0.563	127	159	14
24610-2366	26	3.500	4.500	0.500	89	114	13	24610-2923	26	5.000	6.250	0.625	127	159	16
24610-2374	26	3.500	4.750	0.625	89	121	16	24610-2925	26	5.000	5.750	0.375	127	146	10
24610-2377	26	3.500	4.500	0.438	89	114	11	24610-2929	26	5.000	6.500	0.625	127	165	16
24610-2415	26	3.625	5.000	0.500	92	127	13	24610-2932	26	5.000	5.750	0.437	127	146	11
24610-2417	26	3.625	4.625	0.500	92	117	13	24610-2933	26	5.906	7.480	0.630	150	190	16
24610-2432	26	3.625	5.250	0.500	92	133	13	24610-2939	26-L	11.875	13.375	0.625	302	340	16
24610-2441	26	3.688	4.750	0.500	94	121	13	24610-2967	26	1.750	2.500	0.313	44	64	8
24610-2457	26	3.543	4.724	0.512	90	120	13	24610-2988	26	5.119	6.300	0.591	130	160	15
24610-2459	26	1.750	2.875	0.375	44	73	10	24610-2989	26	5.118	6.299	0.551	130	160	14
24610-2462	26	3.750	4.750	0.500	95	121	13	24610-3008	26	4.500	5.986	0.625	114	152	16
24610-2525	26	3.937	5.250	0.500	100	133	13	24610-3040	26-L	23.750	25.750	0.875	603	654	22
24610-2531	26	6.750	8.250	0.500	171	210	13	24610-3044	26	2.125	3.000	0.328	54	76	8
24610-2538	26-L	12.000	13.000	0.500	305	330	13	24610-3046	26	1.378	2.441	0.500	35	62	13
24610-2541	26	7.087	8.661	0.787	180	220	20	24610-3059	26	5.250	6.250	0.500	133	159	13
24610-2544	26	4.000	5.250	0.563	102	133	14	24610-3060	26	4.000	5.250	0.625	102	133	16
24610-2545	26-L	10.000	11.500	0.562	254	292	14	24610-3065	26	5.250	6.500	0.500	133	165	13
24610-2587	26	4.000	4.750	0.438	102	121	11	24610-3076	26	2.500	3.750	0.469	64	95	12
24610-2600	26	4.125	5.125	0.500	105	130	13	24610-3081	26-L	14.041	15.541	0.625	357	395	16
24610-2603	26	4.125	5.250	0.500	105	133	13	24610-3103	26	4.016	5.236	0.625	102	133	16
24610-2606	26	5.250	7.323	0.500	133	186	13	24610-3129	26	5.375	6.625	0.625	137	168	16
24610-2608	26	4.125	5.375	0.625	105	137	16	24610-3145	26	2.000	2.935	0.375	51	75	10
24610-2612	26	4.125	5.625	0.500	105	143	13	24610-3146	26	2.062	2.875	0.500	52	73	13
24610-2624	26	2.375	3.375	0.438	60	86	11	24610-3176	26	5.500	6.500	0.500	140	165	13
24610-2627	26	4.500	5.250	0.438	114	133	11	24610-3182	26	5.500	6.750	0.500	140	171	13
24610-2637	26	4.188	5.500	0.563	106	140	14	24610-3201	26	5.512	6.299	0.512	140	160	13
24610-2638	26-L	13.780	15.512	0.866	350	394	22	24610-3202	26	2.281	3.062	0.500	58	78	13
24610-2641	26	4.188	5.188	0.500	106	132	13	24610-3207	26	5.125	6.625	0.750	130	168	19
24610-2657	26	4.250	5.250	0.500	108	133	13	24610-3208	26	3.875	5.125	0.563	98	130	14
24610-2674	26	4.250	5.375	0.563	108	137	14	24610-3213	26	2.621	3.371	0.375	67	86	10
24610-2678	26	2.312	3.125	0.437	59	79	11	24610-3215	26	3.250	4.138	0.437	83	105	11
24610-2686	26	4.331	5.118	0.512	110	130	13	24610-3226	26	3.500	4.250	0.438	89	108	11
24610-2691	26-L	18.000	19.500	0.750	457	495	19	24610-3248	26	3.250	4.313	0.500	83	110	13
24610-2697	26	2.188	2.938	0.375	56	75	10	24610-3252	26	2.500	3.875	0.438	64	98	11
24610-2699	26	2.500	3.250	0.375	64	83	10	24610-3262	26	2.000	2.738	0.375	51	70	10
24610-2703	26	4.331	5.512	0.551	110	140	14	24610-3274	26	2.000	2.813	0.500	51	71	13
24610-2708	26	4.375	5.375	0.500	111	137	13	24610-3278	26	2.125	3.500	0.375	54	89	10
24610-2724	26-L	21.654	23.622	0.866	550	600	22	24610-3280	26-L	18.000	20.000	0.812	457	508	21
24610-2732	26	4.438	5.500	0.500	113	140	13	24610-3281	26	5.750	7.000	0.500	146	178	13
24610-2753	26	4.500	5.500	0.500	114	140	13	24610-3283	26	5.750	7.000	0.625	146	178	16
24610-2757	26	4.500	5.625	0.562	114	143	14	24610-3296	26	2.188	3.688	0.500	56	94	13
24610-2761	26	4.500	5.750	0.625	114	146	16	24610-3300	26	2.312	3.062	0.375	59	78	10
24610-2763	26	4.500	5.250	0.375	114	133	10	24610-3302	26-L	11.500	13.672	0.688	292	347	17
24610-2767	26	4.500	6.000	0.625	114	152	16	24610-3327	26	5.906	7.087	0.591	150	180	15

All dimensions are in inches. Preferred sizes are indicated with **bold** type face.

Sizes listed are for standard nitrile elements, except Models 25 and 62 which have PTFE elements. Other material available on inquiry only.

## Oil Seals by Model Number

Product Code	Model	Inches			MM			Product Code	Model	Inches			MM		
		ID	OD	Width	ID	OD	Width			ID	OD	Width	ID	OD	Width
24610-3335	26	2.500	3.375	0.437	64	86	11	24610-3742	26-L	18.000	20.000	1.000	457	508	25
24610-3340	26	2.345	3.095	0.375	60	79	10	24610-3768	26	8.000	9.500	0.687	203	241	17
24610-3354	26	6.000	7.000	0.438	152	178	11	24610-3773	26-L	20.750	22.750	0.875	527	578	22
24610-3355	26	6.000	7.000	0.500	152	178	13	24610-3785	26	5.000	6.375	0.625	127	162	16
24610-3374	26	3.500	4.750	0.438	89	121	11	24610-3827	26	2.688	3.625	0.500	68	92	13
24610-3389	26	6.000	7.500	0.625	152	191	16	24610-3841	26-L	9.500	10.500	0.438	241	267	11
24610-3391	26	1.500	2.313	0.375	38	59	10	24610-3847	26	2.937	3.687	0.375	75	94	10
24610-3396	26	6.250	7.500	0.625	159	191	16	24610-3882	26-L	13.386	14.961	0.709	340	380	18
24610-3401	26	1.969	2.756	0.500	50	70	13	24610-3900	26-L	14.961	16.693	0.866	380	424	22
24610-3412	26	2.353	3.228	0.375	60	82	10	24610-3911	26	7.480	8.859	0.630	190	225	16
24610-3424	26	6.437	7.688	0.625	163	195	16	24610-3925	26-L	8.000	10.000	0.750	203	254	19
24610-3426	26	6.500	7.500	0.625	165	191	16	24610-3937	26-L	8.500	10.000	0.750	216	254	19
24610-3430	26	6.500	7.750	0.625	165	197	16	24610-3951	26-L	8.750	10.750	0.750	222	273	19
24610-3452	26	7.000	8.000	0.437	178	203	11	24610-3955	26-L	9.055	10.236	0.591	230	260	15
24610-3456	26	8.250	9.750	0.500	210	248	13	24610-3977	26	1.875	2.750	0.375	48	70	10
24610-3460	26	6.750	8.000	0.625	171	203	16	24610-3979	26-L	9.500	11.000	0.750	241	279	19
24610-3464	26	6.750	8.250	0.625	171	210	16	24610-4016	26-L	10.500	12.500	0.750	267	318	19
24610-3466	26	2.125	3.100	0.315	54	79	8	24610-4018	26-L	30.512	33.031	0.984	775	839	25
24610-3468	26-L	11.000	12.750	0.750	279	324	19	24610-4044	26	1.772	2.559	0.394	45	65	10
24610-3471	26	3.437	4.688	0.500	87	119	13	24610-4045	26	4.000	5.125	0.500	102	130	13
24610-3477	26	5.000	6.750	0.500	127	171	13	24610-4050	26	2.953	3.740	0.394	75	95	10
24610-3481	26	1.875	2.688	0.469	48	68	12	24610-4052	26-L	11.811	13.386	0.788	300	340	20
24610-3485	26	2.250	3.313	0.500	57	84	13	24610-4059	26-L	11.625	13.625	1.000	295	346	25
24610-3492	26	7.000	8.000	0.625	178	203	16	24610-4067	26-L	12.000	13.500	0.750	305	343	19
24610-3496	26	7.000	8.250	0.625	178	210	16	24610-4071	26-L	12.000	14.000	0.750	305	356	19
24610-3500	26	7.000	8.500	0.625	178	216	16	24610-4074	26-L	12.250	13.750	0.750	311	349	19
24610-3501	26	7.000	8.500	0.750	178	216	19	24610-4075	26-L	9.938	11.437	0.563	252	290	14
24610-3507	26	1.938	2.938	0.438	49	75	11	24610-4080	26-L	12.500	14.000	0.750	318	356	19
24610-3508	26	7.087	8.268	0.551	180	210	14	24610-4090	26-L	12.750	14.750	1.000	324	375	25
24610-3511	26	6.938	8.000	0.625	176	203	16	24610-4093	26-L	13.000	14.500	0.688	330	368	17
24610-3518	26	7.250	8.250	0.625	184	210	16	24610-4098	26-L	13.000	15.000	0.750	330	381	19
24610-3522	26	7.250	8.500	0.625	184	216	16	24610-4127	26-L	13.500	15.500	0.750	343	394	19
24610-3532	26-L	9.500	10.500	0.375	241	267	10	24610-4180	26-L	16.000	18.000	0.813	406	457	21
24610-3544	26	7.500	8.500	0.625	191	216	16	24610-4221	26-L	19.500	21.500	0.875	495	546	22
24610-3548	26	7.500	8.750	0.625	191	222	16	24610-4246	26-L	20.500	22.500	0.875	521	572	22
24610-3563	26	1.750	2.563	0.375	44	65	10	24610-4254	26-L	21.250	23.250	0.875	540	591	22
24610-3566	26	7.625	9.125	0.625	194	232	16	24610-4294	26-L	24.000	26.000	0.875	610	660	22
24610-3589	26	7.875	9.375	0.750	200	238	19	24610-4344	26-L	22.500	24.500	0.875	572	622	22
24610-3591	26	1.938	2.813	0.500	49	71	13	24610-4355	26-L	12.500	14.500	1.000	318	368	25
24610-3592	26	8.000	9.000	0.625	203	229	16	24610-4393	26-L	17.323	18.898	0.787	440	480	20
24610-3596	26	8.000	9.250	0.625	203	235	16	24610-4396	26-L	15.748	17.323	0.787	400	440	20
24610-3599	26	2.188	3.000	0.375	56	76	10	24610-4397	26-L	12.598	14.173	0.787	320	360	20
24610-3601	26	8.000	9.500	0.750	203	241	19	24610-4405	26-L	34.500	36.500	0.875	876	927	22
24610-3606	26	8.250	9.500	0.625	210	241	16	24610-4421	26	1.688	2.437	0.313	43	62	8
24610-3611	26-L	8.625	10.625	0.750	219	270	19	24610-4505	26-L	9.000	10.250	0.625	229	260	16
24610-3621	26-L	9.000	10.750	0.750	229	273	19	24610-4509	26-L	15.748	17.748	0.625	400	451	16
24610-3624	26-L	9.000	11.000	1.000	229	279	25	24610-4515	26-L	9.750	11.000	0.625	248	279	16
24610-3633	26-L	9.250	11.250	1.000	235	286	25	24610-4530	26-L	13.750	15.250	0.750	349	387	19
24610-3643	26	2.875	4.000	0.438	73	102	11	24610-4543	26	3.313	4.249	0.313	84	108	8
24610-3648	26-L	9.500	11.500	1.000	241	292	25	24610-4557	26	3.000	4.000	0.500	76	102	13
24610-3653	26	3.938	5.188	0.563	100	132	14	24610-4614	26	4.500	5.500	0.375	114	140	10
24610-3655	26-L	9.750	11.750	1.000	248	298	25	24610-4651	26	4.000	5.000	0.500	102	127	13
24610-3660	26-L	10.000	11.000	0.562	254	279	14	24610-4674	26-L	14.961	16.693	0.787	380	424	20
24610-3694	26-L	11.000	13.000	1.000	279	330	25	24610-4750	26	5.438	6.438	0.500	138	164	13
24610-3706	26-L	11.750	13.750	1.000	298	349	25	24610-4803	26-L	9.125	10.375	0.625	232	264	16
24610-3723	26	1.188	2.000	0.500	30	51	13	24610-4817	26	3.938	4.938	0.500	100	125	13

All dimensions are in inches. Preferred sizes are indicated with **bold** type face. Sizes listed are for standard nitrile elements, except Models 25 and 62 which have PTFE elements. Other material available on inquiry only.



## Oil Seals by Model Number

Product Code	Model	Inches			MM			Product Code	Model	Inches			MM		
		ID	OD	Width	ID	OD	Width			ID	OD	Width	ID	OD	Width
24610-4869	26-L	11.750	13.250	0.750	298	337	19	24610-5800	26-L	21.000	23.000	0.875	533	584	22
24610-4931	26	2.432	3.444	0.500	62	87	13	24610-5811	26	5.987	7.562	0.630	152	192	16
24610-5002	26	3.543	4.331	0.512	90	110	13	24610-5913	26	3.937	5.000	0.500	100	127	13
24610-5077	26-L	16.000	18.000	0.875	406	457	22	24610-5985	26	4.438	5.938	0.625	113	151	16
24610-5084	26	2.479	3.543	0.500	63	90	13	24610-5997	26	1.500	2.125	0.313	38	54	8
24610-5091	26	4.188	5.313	0.563	106	135	14	24610-6011	26	3.514	4.500	0.512	89	114	13
24610-5092	26	3.688	4.813	0.468	94	122	12	24610-6012	26	4.125	5.125	0.375	105	130	10
24610-5100	26-L	16.500	18.500	0.625	419	470	16	24610-6080	26	2.925	4.000	0.375	74	102	10
24610-5111	26-L	10.236	11.417	0.630	260	290	16	24610-6082	26	2.925	3.925	0.500	74	100	13
24610-5212	26	3.347	4.607	0.493	85	117	13	24610-6083	26	2.675	3.675	0.500	68	93	13
24610-5224	26	3.949	5.197	0.563	100	132	14	24610-6086	26	5.299	6.299	0.500	135	160	13
24610-5260	26-L	24.500	25.625	0.500	622	651	13	24610-6096	26-L	27.843	29.843	0.875	707	758	22
24610-5281	26-L	15.354	17.087	0.787	390	434	20	24610-6101	26	2.750	4.750	0.500	70	121	13
24610-5286	26	7.480	9.055	0.787	190	230	20	24610-6104	26-L	54.000	56.000	0.800	1372	1422	20
24610-5302	26-L	27.953	30.473	0.984	710	774	25	24610-6120	26-L	17.716	19.685	0.866	450	500	22
24610-5315	26	3.621	4.606	0.512	92	117	13	24610-6129	26	3.938	5.000	0.469	100	127	12
24610-5321	26	2.438	4.000	0.500	62	102	13	24610-6153	26-L	15.375	16.875	0.750	391	429	19
24610-5335	26	5.905	7.086	0.590	150	180	15	24610-6175	26	7.250	8.250	0.438	184	210	11
24610-5336	26	2.062	2.997	0.375	52	76	10	24610-6178	26	5.118	6.693	0.630	130	170	16
24610-5338	26	8.267	9.448	0.590	210	240	15	24610-6187	26	7.563	9.062	0.625	192	230	16
24610-5343	26	3.346	4.331	0.512	85	110	13	24610-6190	26-L	16.000	17.500	0.680	406	445	17
24610-5344	26	3.543	4.528	0.512	90	115	13	24610-6194	26-L	16.500	18.500	0.875	419	470	22
24610-5348	26	4.724	5.906	0.551	120	150	14	24610-6217	26-L	41.500	43.500	0.800	1054	1105	20
24610-5353	26	4.134	5.315	0.551	105	135	14	24610-6235	26	4.250	5.750	0.625	108	146	16
24610-5357	26	8.661	9.842	0.590	220	250	15	24610-6237	26	1.750	2.686	0.313	44	68	8
24610-5358	26	2.750	3.687	0.500	70	94	13	24610-6243	26	4.938	6.188	0.500	125	157	13
24610-5374	26	1.595	2.345	0.375	41	60	10	24610-6263	26-L	17.087	19.094	0.748	434	485	19
24610-5380	26	3.150	4.150	0.500	80	105	13	24610-6282	26	2.687	3.751	0.468	68	95	12
24610-5390	26	7.750	9.250	0.500	197	235	13	24610-6285	26-L	14.875	16.875	0.875	378	429	22
24610-5421	26-L	15.500	17.500	0.812	394	445	21	24610-6314	26	4.563	5.813	0.500	116	148	13
24610-5427	26-L	18.750	20.750	0.875	476	527	22	24610-6319	26	3.937	5.197	0.469	100	132	12
24610-5429	26-L	10.236	11.811	0.787	260	300	20	24610-6352	26	2.762	3.700	0.500	70	94	13
24610-5430	26	2.500	3.623	0.468	64	92	12	24610-6372	26	6.750	7.750	0.500	171	197	13
24610-5483	26-L	12.312	13.937	0.750	313	354	19	24610-6384	26	8.500	9.750	0.625	216	248	16
24610-5484	26-L	13.937	15.437	0.750	354	392	19	24610-6386	26-L	8.750	10.000	0.625	222	254	16
24610-5503	26-L	14.214	16.214	0.812	361	412	21	24610-6395	26-L	11.000	13.000	0.750	279	330	19
24610-5553	26-L	30.750	32.750	0.875	781	832	22	24610-6411	26-L	11.813	13.313	0.750	300	338	19
24610-5557	26	1.897	2.835	0.375	48	72	10	24610-6412	26-L	10.236	11.732	0.625	260	298	16
24610-5580	26	8.000	9.055	0.630	203	230	16	24610-6413	26-L	14.173	15.673	0.750	360	398	19
24610-5582	26-L	14.250	16.250	0.750	362	413	19	24610-6434	26-L	8.750	10.250	0.656	222	260	17
24610-5597	26	2.559	4.134	0.500	65	105	13	24610-6471	26	2.750	3.750	0.500	70	95	13
24610-5600	26	7.000	8.562	0.781	178	217	20	24610-6496	26-L	29.528	32.047	0.875	750	814	22
24610-5601	26	6.000	7.562	0.781	152	192	20	24610-6535	26-L	21.000	23.000	0.813	533	584	21
24610-5605	26	5.469	6.469	0.500	139	164	13	24610-6549	26	5.315	6.496	0.551	135	165	14
24610-5608	26	6.625	8.125	0.625	168	206	16	24610-6582	26	6.062	7.312	0.625	154	186	16
24610-5612	26	2.188	3.125	0.438	56	79	11	24610-6669	26	3.937	4.724	0.354	100	120	9
24610-5625	26	7.087	8.465	0.626	180	215	16	24610-6747	26	2.441	3.937	0.500	62	100	13
24610-5631	26	2.500	3.688	0.468	64	94	12	24610-6773	26	7.500	9.000	0.500	191	229	13
24610-5635	26-L	9.449	10.828	0.591	240	275	15	24610-6792	26	7.875	9.375	0.500	200	238	13
24610-5683	26-L	23.622	24.803	0.591	600	630	15	24610-6800	26	3.062	4.125	0.500	78	105	13
24610-5686	26-L	13.625	16.000	0.984	346	406	25	24610-6838	26-L	14.000	15.375	0.709	356	391	18
24610-5688	26-L	20.079	21.260	0.591	510	540	15	24610-6839	26	3.250	4.250	0.437	83	108	11
24610-5704	26	2.438	3.125	0.312	62	79	8	24610-6855	26-L	10.039	11.220	0.591	255	285	15
24610-5720	26	2.756	3.543	0.511	70	90	13	24610-6858	26-L	8.661	10.236	0.591	220	260	15
24610-5782	26-L	24.250	26.750	1.000	616	679	25	24610-6859	26-L	11.625	13.250	0.750	295	337	19
24610-5784	26	4.512	5.512	0.500	115	140	13	24610-7101	26-L	8.500	10.500	0.750	216	267	19

All dimensions are in inches. Preferred sizes are indicated with **bold** type face.

Sizes listed are for standard nitrile elements, except Models 25 and 62 which have PTFE elements. Other material available on inquiry only.

## Oil Seals by Model Number

Product Code	Model	Inches			MM			Product Code	Model	Inches			MM		
		ID	OD	Width	ID	OD	Width			ID	OD	Width	ID	OD	Width
24610-7213	26	3.125	3.875	0.375	79	98	10	24612-3548	26	7.500	8.750	0.625	191	222	16
24610-7267	26	5.512	6.693	0.591	140	170	15	24612-3601	26	8.000	9.500	0.750	203	241	19
24610-7268	26	6.693	7.874	0.591	170	200	15	24612-3705	26-L	11.500	13.500	1.000	292	343	25
24610-7276	26	6.300	7.481	0.591	160	190	15	24612-3934	26	8.500	9.500	0.500	216	241	13
24610-7279	26-L	16.340	18.309	0.866	415	465	22	24612-3951	26-L	8.750	10.750	0.750	222	273	19
24610-7310	26	3.543	5.118	0.630	90	130	16	24612-3978	26-L	9.500	10.500	0.500	241	267	13
24610-7374	26	3.250	4.250	0.500	83	108	13	24612-4082	26-L	12.500	14.500	0.750	318	368	19
24610-7388	26	7.874	9.055	0.591	200	230	15	24612-4505	26-L	9.000	10.250	0.625	229	260	16
24610-7805	26-L	13.000	14.500	0.625	330	368	16	24612-4530	26-L	13.750	15.250	0.750	349	387	19
24610-7807	26	7.087	8.268	0.591	180	210	15	24612-5008	26	1.687	2.625	0.438	43	67	11
24610-7832	26-L	11.250	12.750	0.625	286	324	16	24612-5077	26-L	16.000	18.000	0.875	406	457	22
24610-8313	26-L	9.625	10.875	0.625	244	276	16	24612-5122	26-L	15.000	17.000	0.812	381	432	21
24610-8592	26	3.875	4.875	0.438	98	124	11	24612-5338	26	8.268	9.449	0.591	210	240	15
24610-9137	26	3.437	4.500	0.438	87	114	11	24612-5357	26	8.661	9.843	0.591	220	250	15
24610-9175	26	5.314	6.693	0.512	135	170	13	24612-5422	26	5.118	6.299	0.472	130	160	12
24610-9284	26	3.937	4.725	0.500	100	120	13	24612-6078	26	4.134	5.384	0.500	105	137	13
24610-9388	26-L	9.250	11.250	0.625	235	286	16	24612-6129	26	3.938	5.000	0.469	100	127	12
24610-9460	26-L	17.000	19.000	0.875	432	483	22	24612-6206	26	6.875	8.125	0.625	175	206	16
24610-9662	26	4.000	5.000	0.438	102	127	11	24612-6236	26	8.465	9.646	0.630	215	245	16
24610-9915	26	3.000	4.000	0.438	76	102	11	24612-6378	26	7.500	8.500	0.500	191	216	13
24610-9960	26	4.250	5.250	0.438	108	133	11	24612-6386	26-L	8.750	10.000	0.625	222	254	16
24612-0032	26-L	9.000	11.000	0.625	229	279	16	24612-6471	26	2.750	3.750	0.500	70	95	13
24612-0665	26	4.938	5.938	0.500	125	151	13	24612-6570	26	8.625	9.875	0.625	219	251	16
24612-0691	26	7.250	8.250	0.500	184	210	13	24612-7267	26	5.512	6.693	0.591	140	170	15
24612-0699	26	7.813	8.813	0.500	198	224	13	24612-7268	26	6.693	7.875	0.591	170	200	15
24612-0885	26	2.125	3.250	0.500	54	83	13	24612-7276	26	6.299	7.480	0.591	160	190	15
24612-0901	26	2.750	3.875	0.500	70	98	13	24612-7277	26	4.724	5.906	0.591	120	150	15
24612-0904	26	1.750	2.500	0.375	44	64	10	24612-7292	26-L	11.313	12.813	0.750	287	325	19
24612-0912	26-L	9.313	11.313	1.000	237	287	25	24612-9190	26	3.740	4.724	0.472	95	120	12
24612-0920	26	3.500	4.750	0.500	89	121	13	24612-9284	26	3.937	4.724	0.500	100	120	13
24612-1104	26	1.969	2.756	0.394	50	70	10	24612-9452	26-L	15.500	17.500	0.875	394	445	22
24612-1167	26	6.000	7.520	0.625	152	191	16	24612-9459	26-L	17.500	19.000	0.750	445	483	19
24612-1279	26-L	9.000	10.000	0.437	229	254	11	24614-0287	26	1.000	1.500	0.313	25	38	8
24612-1327	26	7.375	8.625	0.625	187	219	16	24614-0353	26	1.125	1.750	0.375	29	44	10
24612-1454	26	1.375	2.000	0.312	35	51	8	24614-1047	26	2.000	2.500	0.250	51	64	6
24612-1474	26	2.250	3.000	0.375	57	76	10	24614-1244	26	1.500	2.250	0.375	38	57	10
24612-1668	26	2.375	3.500	0.500	60	89	13	24614-1286	26	1.062	1.750	0.375	27	44	10
24612-1950	26	2.625	3.750	0.500	67	95	13	24614-1426	26	1.188	1.813	0.313	30	46	8
24612-2043	26	7.480	8.661	0.591	190	220	15	24614-1454	26	1.375	2.000	0.313	35	51	8
24612-2097	26	4.724	6.299	0.591	120	160	15	24614-1801	26	2.500	3.188	0.375	64	81	10
24612-2098	26	5.512	7.087	0.630	140	180	16	24614-2880	26	1.250	1.875	0.312	32	48	8
24612-2099	26	7.480	9.055	0.630	190	230	16	24614-3292	26	1.125	1.625	0.250	29	41	6
24612-2188	26-L	26.181	28.701	0.984	665	729	25	24614-3293	26	1.686	2.250	0.375	43	57	10
24612-2248	26	8.268	9.646	0.591	210	245	15	24614-3472	26	1.125	1.750	0.313	29	44	8
24612-2377	26	3.500	4.500	0.438	89	114	11	24614-4582	26	2.000	2.625	0.312	51	67	8
24612-2462	26	3.750	4.750	0.500	95	121	13	24618-0831	26-L	37.000	39.250	0.875	940	997	22
24612-2602	26	4.125	5.000	0.438	105	127	11	24618-2007	26-L	12.375	13.375	0.500	314	340	13
24612-2657	26	4.250	5.250	0.500	108	133	13	24618-3040	26-L	23.750	25.750	0.875	603	654	22
24612-2671	26	3.740	4.921	0.472	95	125	12	24618-5157	26-L	40.265	41.765	0.750	1023	1061	19
24612-2753	26	4.500	5.500	0.500	114	140	13	24618-6163	26-L	40.000	42.000	0.800	1016	1067	20
24612-2779	26	4.527	5.512	0.472	115	140	12	24626-0041	26-L	9.250	10.500	0.625	235	267	16
24612-2807	26	8.268	9.449	0.472	210	240	12	24626-0055	26-L	9.500	11.500	0.625	241	292	16
24612-2841	26	4.750	5.500	0.375	121	140	10	24626-0131	26-L	11.750	13.250	0.625	298	337	16
24612-2977	26	3.000	4.000	0.468	76	102	12	24626-0287	26	1.000	1.500	0.313	25	38	8
24612-3475	26	3.825	5.075	0.500	97	129	13	24626-0424	26-L	23.250	25.250	0.750	591	641	19
24612-3489	26-L	27.165	28.740	0.787	690	730	20	24626-0631	26	1.250	2.250	0.500	32	57	13

All dimensions are in inches. Preferred sizes are indicated with **bold** type face. Sizes listed are for standard nitrile elements, except Models 25 and 62 which have PTFE elements. Other material available on inquiry only.

## Oil Seals by Model Number

Product Code	Model	Inches			MM			Product Code	Model	Inches			MM		
		ID	OD	Width	ID	OD	Width			ID	OD	Width	ID	OD	Width
24626-0635	26	1.500	2.500	0.500	38	64	13	24626-2225	26	3.125	4.125	0.500	79	105	13
24626-0639	26	1.750	2.750	0.500	44	70	13	24626-2238	26	3.150	3.938	0.512	80	100	13
24626-0643	26	1.500	2.250	0.375	38	57	10	24626-2274	26	2.756	4.331	0.500	70	110	13
24626-0672	26	5.750	6.750	0.500	146	171	13	24626-2297	26	3.312	4.375	0.500	84	111	13
24626-0674	26	5.875	6.875	0.500	149	175	13	24626-2310	26	3.346	4.134	0.500	85	105	13
24626-0698	26	1.563	2.188	0.313	40	56	8	24626-2321	26	3.375	4.375	0.500	86	111	13
24626-0733	26	1.575	2.362	0.354	40	60	9	24626-2345	26	3.437	4.500	0.500	87	114	13
24626-0737	26	1.438	2.125	0.375	37	54	10	24626-2356	26	3.438	4.875	0.625	87	124	16
24626-0809	26-L	9.000	10.500	0.500	229	267	13	24626-2364	26	3.500	4.375	0.375	89	111	10
24626-0827	26	2.952	3.937	0.511	75	100	13	24626-2366	26	3.500	4.500	0.500	89	114	13
24626-0831	26-L	37.000	39.250	0.875	940	997	22	24626-2368	26	3.500	4.500	0.625	89	114	16
24626-0834	26	1.688	2.502	0.375	43	64	10	24626-2377	26	3.500	4.500	0.438	89	114	11
24626-0841	26	4.527	5.708	0.551	115	145	14	24626-2417	26	3.625	4.625	0.500	92	117	13
24626-0845	26	2.781	3.500	0.375	71	89	10	24626-2447	26	3.688	4.999	0.500	94	127	13
24626-0904	26	1.750	2.500	0.375	44	64	10	24626-2457	26	3.543	4.724	0.511	90	120	13
24626-0914	26	3.125	4.250	0.500	79	108	13	24626-2462	26	3.750	4.750	0.500	95	121	13
24626-0939	26	4.500	5.625	0.500	114	143	13	24626-2562	26	3.307	4.331	0.551	84	110	14
24626-0978	26	4.000	5.000	0.375	102	127	10	24626-2580	26-L	13.250	14.750	0.688	337	375	17
24626-0983	26-L	18.000	20.000	0.625	457	508	16	24626-2600	26	4.125	5.125	0.500	105	130	13
24626-0985	26-L	12.000	13.750	0.688	305	349	17	24626-2603	26	4.125	5.250	0.500	105	133	13
24626-0994	26	4.724	5.708	0.433	120	145	11	24626-2657	26	4.250	5.250	0.500	108	133	13
24626-1039	26	1.875	2.750	0.500	48	70	13	24626-2686	26	4.331	5.118	0.512	110	130	13
24626-1063	26	1.875	3.000	0.375	48	76	10	24626-2731	26	4.331	5.512	0.512	110	140	13
24626-1068	26-L	8.250	10.250	0.750	210	260	19	24626-2732	26	4.438	5.500	0.500	113	140	13
24626-1103	26	1.969	3.150	0.315	50	80	8	24626-2753	26	4.500	5.500	0.500	114	140	13
24626-1139	26	1.378	2.047	0.276	35	52	7	24626-2763	26	4.500	5.250	0.375	114	133	10
24626-1182	26	2.000	3.375	0.375	51	86	10	24626-2765	26	4.500	6.000	0.500	114	152	13
24626-1204	26	2.000	3.000	0.375	51	76	10	24626-2820	26	4.688	5.750	0.500	119	146	13
24626-1321	26	2.125	2.875	0.375	54	73	10	24626-2845	26	4.750	6.000	0.625	121	152	16
24626-1465	26	1.438	2.000	0.313	37	51	8	24626-2853	26	4.750	6.500	0.625	121	165	16
24626-1566	26	2.362	3.149	0.394	60	80	10	24626-2873	26-L	39.370	41.338	0.906	1000	1050	23
24626-1579	26	1.772	2.622	0.500	45	67	13	24626-2875	26	4.875	6.000	0.625	124	152	16
24626-1580	26	2.375	3.250	0.328	60	83	8	24626-2900	26	4.938	6.250	0.500	125	159	13
24626-1642	26	2.375	3.125	0.375	60	79	10	24626-2913	26	4.987	6.000	0.500	127	152	13
24626-1652	26	2.375	3.375	0.500	60	86	13	24626-2915	26	5.000	6.000	0.500	127	152	13
24626-1749	26	2.438	3.500	0.500	62	89	13	24626-2921	26	5.000	6.250	0.500	127	159	13
24626-1820	26	2.500	3.500	0.438	64	89	11	24626-2923	26	5.000	6.250	0.625	127	159	16
24626-1829	26	1.375	2.125	0.375	35	54	10	24626-2928	26	5.000	6.500	0.562	127	165	14
24626-1842	26	2.625	3.625	0.438	67	92	11	24626-2932	26	5.000	5.750	0.437	127	146	11
24626-1907	26	3.937	4.921	0.256	100	125	7	24626-2988	26	5.118	6.299	0.591	130	160	15
24626-1939	26	2.625	3.500	0.375	67	89	10	24626-2998	26	5.125	6.375	0.625	130	162	16
24626-2009	26	1.625	2.250	0.313	41	57	8	24626-3037	26	3.688	4.750	0.438	94	121	11
24626-2020	26	2.750	3.375	0.313	70	86	8	24626-3041	26	6.438	7.500	0.500	164	191	13
24626-2035	26	2.750	3.500	0.375	70	89	10	24626-3059	26	5.250	6.250	0.500	133	159	13
24626-2041	26-L	9.449	11.024	0.591	240	280	15	24626-3122	26	5.375	6.375	0.500	137	162	13
24626-2070	26	2.756	3.543	0.394	70	90	10	24626-3176	26	5.500	6.500	0.500	140	165	13
24626-2098	26	5.512	7.087	0.630	140	180	16	24626-3184	26	5.500	6.750	0.625	140	171	16
24626-2105	26	2.953	4.213	0.492	75	107	12	24626-3329	26	6.693	8.268	0.630	170	210	16
24626-2121	26	2.875	3.875	0.375	73	98	10	24626-3361	26	6.000	7.250	0.500	152	184	13
24626-2128	26	1.250	2.000	0.375	32	51	10	24626-3362	26	6.000	7.000	0.750	152	178	19
24626-2144	26	2.938	3.625	0.375	75	92	10	24626-3379	26	6.000	7.500	0.375	152	191	10
24626-2145	26	7.401	8.582	0.590	188	218	15	24626-3389	26	6.000	7.508	0.625	152	191	16
24626-2147	26	8.189	9.370	0.590	208	238	15	24626-3424	26	6.437	7.687	0.625	163	195	16
24626-2168	26	3.000	3.751	0.375	76	95	10	24626-3435	26	6.500	8.000	0.750	165	203	19
24626-2174	26	3.000	4.003	0.375	76	102	10	24626-3451	26	6.693	7.874	0.295	170	200	7
24626-2187	26	3.000	4.125	0.438	76	105	11	24626-3460	26	6.750	8.000	0.625	171	203	16

All dimensions are in inches. Preferred sizes are indicated with **bold** type face.

Sizes listed are for standard nitrile elements, except Models 25 and 62 which have PTFE elements. Other material available on inquiry only.

## Oil Seals by Model Number

Product Code	Model	Inches			MM			Product Code	Model	Inches			MM		
		ID	OD	Width	ID	OD	Width			ID	OD	Width	ID	OD	Width
24626-3461	26-L	22.047	24.016	0.787	560	610	20	24626-5327	26-L	14.173	15.905	0.787	360	404	20
24626-3492	26	7.000	8.000	0.625	178	203	16	24626-5335	26	5.906	7.087	0.551	150	180	14
24626-3500	26	7.000	8.500	0.625	178	216	16	24626-5338	26	8.268	9.449	0.591	210	240	15
24626-3511	26	6.938	8.000	0.625	176	203	16	24626-5348	26	4.724	5.906	0.551	120	150	14
24626-3522	26	7.250	8.500	0.625	184	216	16	24626-5353	26	4.134	5.315	0.551	105	135	14
24626-3544	26	7.500	8.500	0.625	191	216	16	24626-5359	26-L	9.449	10.630	0.591	240	270	15
24626-3546	26	2.563	3.888	0.750	65	99	19	24626-5409	26	1.496	2.246	0.374	38	57	10
24626-3547	26	2.250	4.751	0.750	57	121	19	24626-5422	26	5.118	6.299	0.472	130	160	12
24626-3548	26	7.500	8.750	0.625	191	222	16	24626-5429	26-L	10.236	11.811	0.787	260	300	20
24626-3587	26	2.165	3.150	0.394	55	80	10	24626-5496	26-L	12.441	14.173	0.787	316	360	20
24626-3596	26	8.000	9.250	0.625	203	235	16	24626-5566	26	3.713	4.972	0.492	94	126	12
24626-3598	26	8.000	9.375	0.625	203	238	16	24626-5598	26	2.756	4.015	0.500	70	102	13
24626-3623	26-L	9.000	11.000	0.750	229	279	19	24626-5715	26	23.622	24.803	0.433	600	630	11
24626-3663	26	2.953	3.740	0.511	75	95	13	24626-5918	26	1.575	2.047	0.276	40	52	7
24626-3665	26-L	10.500	11.750	0.625	267	298	16	24626-5942	26-L	12.750	14.250	0.750	324	362	19
24626-3680	26-L	10.500	12.500	1.000	267	318	25	24626-6185	26	7.750	8.750	0.437	197	222	11
24626-3682	26-L	10.750	11.750	0.563	273	298	14	24626-6204	26	6.890	8.465	0.591	175	215	15
24626-3696	26-L	11.417	13.150	0.787	290	334	20	24626-6374	26	7.000	8.000	0.500	178	203	13
24626-3720	26-L	11.000	12.250	0.688	279	311	17	24626-6378	26	7.500	8.500	0.500	191	216	13
24626-3742	26-L	18.000	20.000	1.000	457	508	25	24626-6386	26-L	8.750	10.000	0.625	222	254	16
24626-3825	26	8.625	9.625	0.500	219	244	13	24626-6542	26	3.917	4.724	0.472	99	120	12
24626-3828	26-L	8.625	10.500	0.500	219	267	13	24626-6543	26	4.508	5.512	0.472	115	140	12
24626-3853	26-L	12.000	14.000	0.625	305	356	16	24626-6607	26	5.886	7.087	0.512	150	180	13
24626-3882	26-L	13.386	14.961	0.709	340	380	18	24626-6608	26	6.476	7.480	0.512	164	190	13
24626-3914	26	7.874	9.055	0.551	200	230	14	24626-6808	26-L	10.000	11.250	0.625	254	286	16
24626-3916	26	7.874	9.449	0.787	200	240	20	24626-6817	26	6.500	7.500	0.500	165	191	13
24626-3919	26	6.693	7.874	0.630	170	200	16	24626-7209	26	2.165	3.938	0.375	55	100	10
24626-3920	26	7.087	8.268	0.630	180	210	16	24626-7267	26	5.512	6.693	0.591	140	170	15
24626-3944	26-L	8.661	10.236	0.866	220	260	22	24626-7276	26	6.299	7.480	0.591	160	190	15
24626-3955	26-L	9.055	10.236	0.591	230	260	15	24626-7288	26-L	10.433	11.683	0.625	265	297	16
24626-3973	26-L	9.449	11.024	0.748	240	280	19	24626-7374	26	3.250	4.250	0.500	83	108	13
24626-4006	26-L	10.500	12.500	0.625	267	318	16	24626-7832	26-L	11.250	12.750	0.625	286	324	16
24626-4044	26	1.772	2.559	0.394	45	65	10	24626-7836	26	4.724	6.299	0.472	120	160	12
24626-4068	26-L	12.000	13.625	0.750	305	346	19	24626-9175	26	5.315	6.693	0.512	135	170	13
24626-4098	26-L	13.000	15.000	0.750	330	381	19	24626-9646	26	3.937	5.062	0.375	100	129	10
24626-4155	26-L	15.000	17.000	0.750	381	432	19	24626-9662	26	4.000	5.000	0.438	102	127	11
24626-4394	26-L	14.173	15.748	0.709	360	400	18	24626-9708	26	4.375	5.375	0.687	111	137	17
24626-4396	26-L	15.748	17.323	0.787	400	440	20	24626-9780	26	6.500	7.500	0.563	165	191	14
24626-4397	26-L	12.598	14.173	0.787	320	360	20	24626-9960	26	4.250	5.250	0.438	108	133	11
24626-4520	26	1.938	2.875	0.313	49	73	8	24627-0067	26-L	9.875	11.375	0.750	251	289	19
24626-4530	26-L	13.750	15.250	0.750	349	387	19	24627-0081	26-L	10.250	11.750	0.625	260	298	16
24626-4557	26	3.000	4.000	0.500	76	102	13	24627-0106	26-L	11.000	12.250	0.625	279	311	16
24626-4558	26	4.921	5.906	0.512	125	150	13	24627-0107	26-L	11.000	13.000	0.625	279	330	16
24626-4612	26-L	12.000	13.500	0.688	305	343	17	24627-0217	26-L	14.000	16.000	0.750	356	406	19
24626-4644	26-L	9.750	10.750	0.438	248	273	11	24627-0420	26-L	23.000	25.000	0.875	584	635	22
24626-4651	26	4.000	5.000	0.500	102	127	13	24627-0467	26-L	26.500	28.000	0.750	673	711	19
24626-4710	26	3.435	5.000	0.500	87	127	13	24627-0516	26-L	32.000	34.000	0.875	813	864	22
24626-4854	26	3.150	4.409	0.492	80	112	12	24627-0520	26-L	32.500	34.500	0.875	826	876	22
24626-4870	26	3.125	4.500	0.472	79	114	12	24627-0536	26-L	34.000	36.000	0.875	864	914	22
24626-4873	26	4.500	5.500	0.437	114	140	11	24627-0621	26-L	14.000	15.500	0.750	356	394	19
24626-4997	26	7.480	8.465	0.630	190	215	16	24627-0633	26	1.375	2.375	0.500	35	60	13
24626-5002	26	3.543	4.330	0.511	90	110	13	24627-0642	26	2.188	3.188	0.500	56	81	13
24626-5077	26-L	16.000	18.000	0.875	406	457	22	24627-0643	26	1.500	2.250	0.375	38	57	10
24626-5115	26	2.362	3.150	0.394	60	80	10	24627-0645	26	2.437	3.437	0.500	62	87	13
24626-5239	26	1.250	1.750	0.250	32	44	6	24627-0649	26	2.875	3.875	0.500	73	98	13
24626-5273	26	7.188	8.640	0.625	183	219	16	24627-0658	26	4.062	5.062	0.500	103	129	13

All dimensions are in inches. Preferred sizes are indicated with **bold** type face.  
 Sizes listed are for standard nitrile elements, except Models 25 and 62 which have PTFE elements. Other material available on inquiry only.

## Oil Seals by Model Number

Product Code	Model	Inches			MM			Product Code	Model	Inches			MM		
		ID	OD	Width	ID	OD	Width			ID	OD	Width	ID	OD	Width
24627-0666	26	5.062	6.062	0.500	129	154	13	24627-2587	26	4.000	4.750	0.438	102	121	11
24627-0678	26	6.250	7.250	0.500	159	184	13	24627-2603	26	4.125	5.250	0.500	105	133	13
24627-0682	26	6.500	7.500	0.500	165	191	13	24627-2657	26	4.250	5.250	0.500	108	133	13
24627-0717	26	1.625	2.500	0.500	41	64	13	24627-2686	26	4.331	5.118	0.512	110	130	13
24627-0760	26	1.625	2.375	0.375	41	60	10	24627-2699	26	2.500	3.250	0.375	64	83	10
24627-0771	26	1.625	2.500	0.500	41	64	13	24627-2753	26	4.500	5.500	0.500	114	140	13
24627-0800	26-L	10.000	12.000	1.000	254	305	25	24627-2767	26	4.500	6.000	0.625	114	152	16
24627-0811	26	4.250	5.500	0.625	108	140	16	24627-2798	26	4.625	5.625	0.500	117	143	13
24627-0813	26	3.375	4.125	0.375	86	105	10	24627-2815	26	4.625	6.125	0.562	117	156	14
24627-0904	26	1.750	2.500	0.375	44	64	10	24627-2837	26	4.750	5.750	0.500	121	146	13
24627-0912	26-L	9.313	11.313	1.000	237	287	25	24627-2921	26	5.000	6.250	0.500	127	159	13
24627-0920	26	3.500	4.750	0.500	89	121	13	24627-2923	26	5.000	6.250	0.625	127	159	16
24627-0922	26	3.500	5.000	0.500	89	127	13	24627-2928	26	5.000	6.500	0.562	127	165	14
24627-0923	26	3.625	4.875	0.500	92	124	13	24627-2967	26	1.750	2.500	0.313	44	64	8
24627-0943	26	4.750	6.000	0.500	121	152	13	24627-2984	26-L	9.000	10.500	0.656	229	267	17
24627-1042	26	1.875	2.625	0.375	48	67	10	24627-2990	26	5.125	6.125	0.500	130	156	13
24627-1059	26	1.875	2.875	0.500	48	73	13	24627-3035	26	7.087	8.071	0.629	180	205	16
24627-1068	26-L	8.250	10.250	0.750	210	260	19	24627-3065	26	5.250	6.500	0.500	133	165	13
24627-1135	26-L	22.000	24.000	0.875	559	610	22	24627-3122	26	5.375	6.375	0.500	137	162	13
24627-1321	26	2.125	2.875	0.375	54	73	10	24627-3129	26	5.375	6.625	0.625	137	168	16
24627-1474	26	2.250	3.000	0.375	57	76	10	24627-3155	26	3.938	5.000	0.625	100	127	16
24627-1494	26	2.250	3.250	0.500	57	83	13	24627-3176	26	5.500	6.500	0.500	140	165	13
24627-1566	26	2.362	3.150	0.394	60	80	10	24627-3192	26	4.938	6.438	0.750	125	164	19
24627-1642	26	2.375	3.125	0.375	60	79	10	24627-3211	26	5.000	6.500	0.750	127	165	19
24627-1652	26	2.375	3.375	0.500	60	86	13	24627-3233	26-L	15.250	16.625	0.531	387	422	13
24627-1721	26	7.750	9.000	0.625	197	229	16	24627-3254	26	1.750	2.625	0.375	44	67	10
24627-1820	26	2.500	3.500	0.437	64	89	11	24627-3261	26	2.310	3.063	0.313	59	78	8
24627-1867	26-L	17.000	19.000	0.813	432	483	21	24627-3277	26	5.750	6.750	0.625	146	171	16
24627-1963	26	5.512	7.087	0.591	140	180	15	24627-3300	26	2.313	3.062	0.375	59	78	10
24627-1972	26	2.000	2.750	0.375	51	70	10	24627-3303	26	2.160	2.880	0.375	55	73	10
24627-1973	26-L	18.000	21.000	0.750	457	533	19	24627-3329	26	6.693	8.268	0.630	170	210	16
24627-1977	26-L	20.000	22.000	0.750	508	559	19	24627-3335	26	2.500	3.375	0.437	64	86	11
24627-1991	26-L	21.000	23.000	0.875	533	584	22	24627-3368	26	2.440	3.693	0.469	62	94	12
24627-2035	26	2.750	3.500	0.375	70	89	10	24627-3370	26	6.000	7.500	0.750	152	191	19
24627-2043	26	7.480	8.661	0.591	190	220	15	24627-3374	26	3.500	4.750	0.438	89	121	11
24627-2121	26	2.875	3.875	0.375	73	98	10	24627-3389	26	6.000	7.508	0.625	152	191	16
24627-2167	26	2.938	4.000	0.500	75	102	13	24627-3391	26	1.500	2.313	0.375	38	59	10
24627-2168	26	3.000	3.750	0.375	76	95	10	24627-3424	26	6.438	7.688	0.625	164	195	16
24627-2186	26	3.000	4.500	0.500	76	114	13	24627-3430	26	6.500	7.750	0.625	165	197	16
24627-2225	26	3.125	4.125	0.500	79	105	13	24627-3433	26-L	23.000	25.000	0.826	584	635	21
24627-2242	26	3.149	3.938	0.393	80	100	10	24627-3434	26	6.500	8.000	0.625	165	203	16
24627-2249	26	3.188	4.249	0.500	81	108	13	24627-3482	26	2.500	3.375	0.375	64	86	10
24627-2276	26	3.250	4.500	0.500	83	114	13	24627-3485	26	2.250	3.313	0.500	57	84	13
24627-2310	26	3.347	4.134	0.512	85	105	13	24627-3501	26	7.000	8.500	0.750	178	216	19
24627-2321	26	3.375	4.375	0.500	86	111	13	24627-3522	26	7.250	8.500	0.625	184	216	16
24627-2366	26	3.500	4.500	0.500	89	114	13	24627-3527	26	7.250	8.750	0.750	184	222	19
24627-2415	26	3.625	5.000	0.500	92	127	13	24627-3536	26	6.000	8.000	0.500	152	203	13
24627-2417	26	3.625	4.625	0.500	92	117	13	24627-3553	26	7.500	9.000	0.750	191	229	19
24627-2462	26	3.750	4.750	0.500	95	121	13	24627-3558	26	6.300	7.800	0.750	160	198	19
24627-2468	26	1.250	2.250	0.375	32	57	10	24627-3569	26	2.188	3.437	0.375	56	87	10
24627-2525	26	3.938	5.250	0.500	100	133	13	24627-3574	26	4.125	4.875	0.375	105	124	10
24627-2541	26	7.087	8.661	0.787	180	220	20	24627-3596	26	8.000	9.250	0.625	203	235	16
24627-2544	26	4.000	5.250	0.563	102	133	14	24627-3599	26	2.188	3.000	0.375	56	76	10
24627-2565	26-L	16.500	18.500	0.812	419	470	21	24627-3601	26	8.000	9.500	0.750	203	241	19
24627-2572	26-L	11.750	13.750	0.750	298	349	19	24627-3602	26-L	8.000	10.000	1.000	203	254	25
24627-2573	26	5.250	6.750	0.750	133	171	19	24627-3619	26-L	9.000	10.500	0.750	229	267	19

All dimensions are in inches. Preferred sizes are indicated with **bold** type face.

Sizes listed are for standard nitrile elements, except Models 25 and 62 which have PTFE elements. Other material available on inquiry only.

## Oil Seals by Model Number

Product Code	Model	Inches			MM			Product Code	Model	Inches			MM		
		ID	OD	Width	ID	OD	Width			ID	OD	Width	ID	OD	Width
24627-3623	26-L	9.000	11.000	0.750	229	279	19	24627-6263	26-L	17.087	19.094	0.748	434	485	19
24627-3625	26-L	9.125	11.125	1.000	232	283	25	24627-6333	26	5.625	7.125	0.375	143	181	10
24627-3643	26	2.875	4.000	0.438	73	102	11	24627-6334	26	3.625	4.625	0.375	92	117	10
24627-3648	26-L	9.500	11.500	1.000	241	292	25	24627-6370	26	6.500	8.000	0.500	165	203	13
24627-3666	26	1.938	2.750	0.500	49	70	13	24627-6384	26	8.500	9.750	0.625	216	248	16
24627-3680	26-L	10.500	12.500	1.000	267	318	25	24627-6386	26-L	8.750	10.000	0.625	222	254	16
24627-3696	26-L	11.417	13.150	0.787	290	334	20	24627-6400	26-L	20.000	22.000	0.813	508	559	21
24627-3774	26-L	25.000	27.000	0.875	635	686	22	24627-6405	26-L	16.000	19.000	0.750	406	483	19
24627-3850	26-L	11.500	12.500	0.500	292	318	13	24627-6411	26-L	11.813	13.313	0.750	300	338	19
24627-3876	26-L	30.500	32.500	0.875	775	826	22	24627-6471	26	2.750	3.750	0.500	70	95	13
24627-3913	26	6.299	7.480	0.630	160	190	16	24627-6473	26-L	15.874	18.000	0.984	403	457	25
24627-3925	26-L	8.000	10.000	0.750	203	254	19	24627-6474	26-L	20.906	24.000	0.750	531	610	19
24627-3951	26-L	8.750	10.750	0.750	222	273	19	24627-6480	26	2.735	3.485	0.375	69	89	10
24627-3959	26-L	8.500	10.000	0.500	216	254	13	24627-6615	26-L	11.688	13.188	0.750	297	335	19
24627-3979	26-L	9.500	11.000	0.750	241	279	19	24627-6669	26	3.937	4.724	0.354	100	120	9
24627-4006	26-L	10.500	12.500	0.625	267	318	16	24627-6697	26-L	19.000	21.000	0.813	483	533	21
24627-4016	26-L	10.500	12.500	0.750	267	318	19	24627-6817	26	6.500	7.500	0.500	165	191	13
24627-4060	26-L	13.375	14.875	0.653	340	378	17	24627-6839	26	3.250	4.250	0.438	83	108	11
24627-4068	26-L	12.000	13.625	0.750	305	346	19	24627-6903	26-L	15.354	17.323	0.866	390	440	22
24627-4071	26-L	12.000	14.000	0.750	305	356	19	24627-7276	26	6.299	7.480	0.591	160	190	15
24627-4082	26-L	12.500	14.500	0.750	318	368	19	24627-7374	26	3.250	4.250	0.500	83	108	13
24627-4090	26-L	12.750	14.750	1.000	324	375	25	24627-7383	26	5.512	6.693	0.551	140	170	14
24627-4254	26-L	21.250	23.250	0.875	540	591	22	24627-7805	26-L	13.000	14.500	0.625	330	368	16
24627-4355	26-L	12.500	14.500	1.000	318	368	25	24627-9452	26-L	15.500	17.500	0.875	394	445	22
24627-4505	26-L	9.000	10.250	0.625	229	260	16	24629-2965	26-L	10.630	12.205	0.787	270	310	20
24627-4508	26-L	18.110	19.685	0.787	460	500	20	24629-3235	26-L	12.992	14.567	0.482	330	370	12
24627-4509	26-L	15.748	17.748	0.625	400	451	16	24629-3640	26-L	9.500	10.750	0.625	241	273	16
24627-4510	26-L	12.500	14.000	0.653	318	356	17	24629-4006	26-L	10.500	12.500	0.625	267	318	16
24627-4557	26	3.000	4.000	0.500	76	102	13	24631-1933	26-L	30.709	33.228	0.984	780	844	25
24627-4702	26-L	11.422	12.922	0.750	290	328	19	24631-2628	26-L	22.750	24.330	0.578	578	618	15
24627-4941	26-L	15.354	16.929	0.787	390	430	20	24631-3522	26	7.250	8.500	0.625	184	216	16
24627-4950	26-L	10.000	11.500	0.625	254	292	16	24635-0758	26	1.625	2.188	0.375	41	56	10
24627-5077	26-L	16.000	18.000	0.875	406	457	22	24635-2225	26	3.125	4.125	0.500	79	105	13
24627-5302	26-L	27.953	30.472	0.984	710	774	25	24635-5239	26	1.250	1.750	0.250	32	44	6
24627-5310	26	3.000	4.437	0.625	76	113	16	24637-0576	26	1.378	2.087	.354	35	53	9
24627-5330	26-L	10.039	11.417	0.591	255	290	15	24637-0735	26	1.575	2.283	.354	40	58	9
24627-5338	26	8.267	9.448	0.590	210	240	15	24637-0968	26	1.811	2.520	.354	46	64	9
24627-5351	26-L	10.236	11.417	0.590	260	290	15	24637-0996	26	10.433	11.417	.630	265	290	16
24627-5357	26	8.661	9.843	0.591	220	250	15	24637-2560	26	3.938	4.724	.394	100	120	10
24627-5392	26-L	15.748	17.717	0.866	400	450	22	24637-2794	26	4.528	5.315	.394	115	135	10
24627-5421	26-L	15.500	17.500	0.812	394	445	21	24637-2835	26	4.724	5.512	.394	120	140	10
24627-5475	26-L	15.750	17.250	0.750	400	438	19	24637-3206	26	5.512	6.378	.472	140	162	12
24627-5528	26-L	53.000	55.000	0.800	1346	1397	20	24637-3313	26	6.102	6.968	.472	155	177	12
24627-5557	26	1.897	2.835	0.375	48	72	10	24637-3327	26	5.906	7.087	.591	150	180	15
24627-5580	26	8.000	9.055	0.630	203	230	16	24637-3955	26	9.055	10.236	.591	230	260	15
24627-5600	26	7.000	8.562	0.781	178	217	20	24637-4955	26	8.268	9.134	.472	210	232	12
24627-5629	26	8.625	9.625	0.562	219	244	14	24637-4956	26	7.875	8.740	.472	200	222	12
24627-5630	26	8.625	9.625	0.468	219	244	12	24637-4960	26	7.480	8.346	.472	190	212	12
24627-5720	26	2.756	3.543	0.512	70	90	13	24637-4962	26	6.693	7.559	.472	170	192	12
24627-5770	26	7.250	8.000	0.625	184	203	16	24637-7276	26	6.299	7.480	.591	160	190	15
24627-5800	26-L	21.000	23.000	0.875	533	584	22	24637-7807	26	7.087	8.268	.591	180	210	15
24627-5814	26-L	9.055	10.630	0.590	230	270	15	24638-0827	26	2.953	3.938	.512	75	100	13
24627-5923	26-L	27.953	29.921	0.787	710	760	20	24638-2559	26	3.938	4.921	.472	100	125	12
24627-6106	26	6.672	7.902	0.750	169	201	19	24638-2863	26	4.724	5.906	.512	120	150	13
24627-6189	26-L	21.000	22.181	0.591	533	563	15	24638-2989	26	5.118	6.299	.551	130	160	14
24627-6237	26	1.750	2.686	0.313	44	68	8	24638-3205	26	5.512	6.693	.512	140	170	13

All dimensions are in inches. Preferred sizes are indicated with **bold** type face. Sizes listed are for standard nitrile elements, except Models 25 and 62 which have PTFE elements. Other material available on inquiry only.

## Oil Seals by Model Number

Product Code	Model	Inches			MM			Product Code	Model	Inches			MM		
		ID	OD	Width	ID	OD	Width			ID	OD	Width	ID	OD	Width
24638-3310	26	5.906	7.087	.512	150	180	13	21086-2188	53	3.000	4.500	0.625	76	114	16
24638-3311	26	6.102	7.283	.591	155	185	15	21086-2189	53	3.000	4.625	0.500	76	117	13
24638-3327	26	5.906	7.087	.591	150	180	15	21086-2192	53	3.000	4.750	0.500	76	121	13
24638-3955	26-L	9.055	10.236	.591	230	260	15	21086-2195	53	3.000	4.875	0.500	76	124	13
24638-7276	26	6.299	7.480	.591	160	190	15	21086-2198	53	3.000	5.000	0.500	76	127	13
24638-8420	26	7.875	9.449	.630	200	240	16	21086-2201	53	3.063	4.125	0.500	78	105	13
24638-9963	26	3.543	4.528	.472	90	115	12	21086-2202	53	3.062	4.125	0.563	78	105	14
24641-1332	26-L	15.748	17.480	0.787	400	444	20	21086-2204	53	3.063	4.249	0.500	78	108	13
24641-3740	26-L	16.929	18.898	0.866	430	480	22	21086-2210	53	3.062	4.500	0.500	78	114	13
24641-4066	26-L	22.047	23.780	0.787	560	604	20	21086-2219	53	3.063	4.875	0.500	78	124	13
24641-5327	26-L	14.173	15.906	0.787	360	404	20	21086-2221	53	3.062	4.875	0.625	78	124	16
24648-1033	26	3.150	3.937	0.394	80	100	10	21086-2222	53	3.063	5.000	0.500	78	127	13
24648-5623	26	2.559	4.134	0.472	65	105	12	21086-2225	53	3.125	4.125	0.500	79	105	13
24648-7383	26	5.512	6.693	0.511	140	170	13	21086-2226	53	3.125	4.125	0.563	79	105	14
24649-0916	26	3.250	4.375	0.500	83	111	13	21086-2228	53	3.125	4.249	0.500	79	108	13
24649-1454	26	1.375	2.000	0.313	35	51	8	21086-2229	53	3.125	4.249	0.563	79	108	14
24649-2880	26	1.250	1.875	0.313	32	48	8	21086-2230	53	3.125	4.249	0.625	79	108	16
24649-5361	26	2.437	3.125	0.375	62	79	10	21086-2231	53	3.125	4.375	0.500	79	111	13
24650-5359	26-L	9.449	10.630	0.591	240	270	15	21086-2234	53	3.125	4.500	0.500	79	114	13
24657-3691	26-L	11.000	12.000	0.625	279	305	16	21086-2236	53	3.125	4.500	0.625	79	114	16
24658-2873	26-L	39.370	41.339	0.906	1000	1050	23	21086-2237	53	3.125	4.625	0.500	79	117	13
24667-0621	26-L	14.000	15.500	0.750	356	394	19	21086-2240	53	3.125	4.750	0.500	79	121	13
24667-2765	26	4.500	6.000	0.500	114	152	13	21086-2243	53	3.125	4.875	0.500	79	124	13
24667-3910	26-L	9.449	10.827	0.630	240	275	16	21086-2246	53	3.125	5.000	0.500	79	127	13
24667-5155	26	7.874	9.055	0.492	200	230	12	21086-2249	53	3.188	4.249	0.500	81	108	13
24667-5633	26-L	11.653	12.835	0.630	296	326	16	21086-2252	53	3.188	4.375	0.500	81	111	13
24683-0631	26	1.250	2.250	0.500	32	57	13	21086-2254	53	3.188	4.375	0.625	81	111	16
24683-0635	26	1.500	2.500	0.500	38	64	13	21086-2255	53	3.188	4.500	0.500	81	114	13
24683-0708	26	1.375	2.439	0.500	35	62	13	21086-2261	53	3.188	4.750	0.500	81	121	13
24683-0904	26	1.750	2.500	0.375	44	64	10	21086-2264	53	3.188	4.875	0.500	81	124	13
24683-1206	26	2.000	3.000	0.500	51	76	13	21086-2267	53	3.188	5.000	0.500	81	127	13
24683-1821	26	2.500	3.500	0.500	64	89	13	21086-2270	53	3.250	4.249	0.500	83	108	13
24683-2753	26	4.500	5.500	0.500	114	140	13	21086-2271	53	3.250	4.249	0.563	83	108	14
24683-4557	26	3.000	4.000	0.500	76	102	13	21086-2272	53	3.250	4.249	0.625	83	108	16
24683-4651	26	4.000	5.000	0.500	102	127	13	21086-2273	53	3.250	4.375	0.500	83	111	13
21020-2297	50	3.313	4.375	0.500	84	111	13	21086-2276	53	3.250	4.500	0.500	83	114	13
21020-3319	50	5.875	7.000	0.500	149	178	13	21086-2277	53	3.250	4.500	0.563	83	114	14
21020-3355	50	6.000	7.000	0.500	152	178	13	21086-2278	53	3.250	4.500	0.625	83	114	16
21020-3396	50	6.250	7.500	0.625	159	191	16	21086-2279	53	3.250	4.625	0.500	83	117	13
21020-3492	50	7.000	8.000	0.625	178	203	16	21086-2282	53	3.250	4.750	0.500	83	121	13
21020-3996	50	10.000	12.000	0.750	254	305	19	21086-2284	53	3.250	4.750	0.625	83	121	16
21017-3709	51-L	12.000	14.000	1.000	305	356	25	21086-2287	53	3.250	4.875	0.625	83	124	16
21022-3680	51	10.500	12.500	1.000	267	318	25	21086-2288	53	3.250	5.000	0.500	83	127	13
21022-3709	51-L	12.000	14.000	1.000	305	356	25	21086-2297	53	3.313	4.375	0.500	84	111	13
21486-3680	51	10.500	12.500	1.000	267	318	25	21086-2300	53	3.313	4.500	0.500	84	114	13
21486-3709	51-L	12.000	14.000	1.000	305	356	25	21086-2302	53	3.312	4.500	0.625	84	114	16
21619-3680	51	10.500	12.500	1.000	267	318	25	21086-2303	53	3.313	4.625	0.500	84	117	13
21619-3709	51-L	12.000	14.000	1.000	305	356	25	21086-2306	53	3.313	4.750	0.500	84	121	13
23704-7721	52	1.933	2.441	0.625	49	62	16	21086-2312	53	3.313	5.000	0.500	84	127	13
21086-0989	53	3.313	5.250	0.500	84	133	13	21086-2315	53	3.313	5.125	0.500	84	130	13
21086-2177	53	3.000	4.125	0.500	76	105	13	21086-2321	53	3.375	4.375	0.500	86	111	13
21086-2178	53	3.000	4.125	0.563	76	105	14	21086-2323	53	3.375	4.375	0.625	86	111	16
21086-2180	53	3.000	4.249	0.500	76	108	13	21086-2324	53	3.375	4.500	0.500	86	114	13
21086-2182	53	3.000	4.249	0.625	76	108	16	21086-2326	53	3.375	4.500	0.625	86	114	16
21086-2183	53	3.000	4.375	0.500	76	111	13	21086-2327	53	3.375	4.625	0.500	86	117	13
21086-2186	53	3.000	4.500	0.500	76	114	13	21086-2329	53	3.375	4.625	0.625	86	117	16

All dimensions are in inches. Preferred sizes are indicated with **bold** type face.

Sizes listed are for standard nitrile elements, except Models 25 and 62 which have PTFE elements. Other material available on inquiry only.

## Oil Seals by Model Number

Product Code	Model	Inches			MM			Product Code	Model	Inches			MM		
		ID	OD	Width	ID	OD	Width			ID	OD	Width	ID	OD	Width
21086-2330	53	3.375	4.750	0.500	86	121	13	21086-2465	53	3.750	4.875	0.500	95	124	13
21086-2333	53	3.375	4.875	0.500	86	124	13	21086-2468	53	3.750	4.999	0.500	95	127	13
21086-2336	53	3.375	5.000	0.500	86	127	13	21086-2469	53	3.750	4.999	0.562	95	127	14
21086-2339	53	3.375	5.125	0.500	86	130	13	21086-2470	53	3.750	4.999	0.625	95	127	16
21086-2342	53	3.375	5.250	0.500	86	133	13	21086-2471	53	3.750	5.125	0.500	95	130	13
21086-2345	53	3.438	4.500	0.500	87	114	13	21086-2474	53	3.750	5.250	0.500	95	133	13
21086-2348	53	3.438	4.625	0.500	87	117	13	21086-2476	53	3.750	5.250	0.625	95	133	16
21086-2351	53	3.438	4.750	0.500	87	121	13	21086-2480	53	3.750	5.500	0.500	95	140	13
21086-2353	53	3.437	4.750	0.625	87	121	16	21086-2483	53	3.813	4.875	0.500	97	124	13
21086-2354	53	3.438	4.875	0.500	87	124	13	21086-2486	53	3.813	5.000	0.500	97	127	13
21086-2356	53	3.438	4.875	0.625	87	124	16	21086-2489	53	3.812	5.125	0.500	97	130	13
21086-2357	53	3.438	5.000	0.500	87	127	13	21086-2492	53	3.813	5.250	0.500	97	133	13
21086-2360	53	3.438	5.125	0.500	87	130	13	21086-2495	53	3.813	5.375	0.500	97	137	13
21086-2362	53	3.437	5.125	0.625	87	130	16	21086-2498	53	3.813	5.500	0.500	97	140	13
21086-2363	53	3.438	5.250	0.500	87	133	13	21086-2501	53	3.875	4.875	0.500	98	124	13
21086-2365	53	3.437	5.250	0.625	87	133	16	21086-2504	53	3.875	5.000	0.500	98	127	13
21086-2366	53	3.500	4.500	0.500	89	114	13	21086-2506	53	3.875	4.999	0.625	98	127	16
21086-2367	53	3.500	4.500	0.563	89	114	14	21086-2507	53	3.875	5.125	0.500	98	130	13
21086-2368	53	3.500	4.500	0.625	89	114	16	21086-2510	53	3.875	5.250	0.500	98	133	13
21086-2369	53	3.500	4.625	0.500	89	117	13	21086-2511	53	3.875	5.250	0.563	98	133	14
21086-2370	53	3.500	4.625	0.563	89	117	14	21086-2513	53	3.875	5.375	0.500	98	137	13
21086-2372	53	3.500	4.750	0.500	89	121	13	21086-2516	53	3.875	5.500	0.500	98	140	13
21086-2374	53	3.500	4.750	0.625	89	121	16	21086-2519	53	3.938	4.999	0.500	100	127	13
21086-2375	53	3.500	4.875	0.500	89	124	13	21086-2521	53	3.938	5.000	0.625	100	127	16
21086-2378	53	3.500	4.999	0.500	89	127	13	21086-2522	53	3.938	5.125	0.500	100	130	13
21086-2381	53	3.500	5.125	0.500	89	130	13	21086-2525	53	3.938	5.250	0.500	100	133	13
21086-2384	53	3.500	5.250	0.500	89	133	13	21086-2527	53	3.938	5.250	0.625	100	133	16
21086-2386	53	3.500	5.250	0.625	89	133	16	21086-2528	53	3.938	5.375	0.500	100	137	13
21086-2387	53	3.500	5.375	0.500	89	137	13	21086-2531	53	3.938	5.500	0.500	100	140	13
21086-2390	53	3.500	5.500	0.500	89	140	13	21086-2534	53	3.938	5.625	0.500	100	143	13
21086-2392	53	3.500	5.500	0.625	89	140	16	21086-2537	53	4.000	4.999	0.500	102	127	13
21086-2393	53	3.563	4.625	0.500	91	117	13	21086-2539	53	4.000	5.000	0.625	102	127	16
21086-2396	53	3.563	4.750	0.500	91	121	13	21086-2540	53	4.000	5.125	0.500	102	130	13
21086-2399	53	3.563	4.875	0.500	91	124	13	21086-2541	53	4.000	5.125	0.563	102	130	14
21086-2402	53	3.563	5.000	0.500	91	127	13	21086-2542	53	4.000	5.125	0.625	102	130	16
21086-2408	53	3.563	5.250	0.500	91	133	13	21086-2543	53	4.000	5.250	0.500	102	133	13
21086-2417	53	3.625	4.625	0.500	92	117	13	21086-2544	53	4.000	5.250	0.563	102	133	14
21086-2419	53	3.625	4.625	0.625	92	117	16	21086-2545	53	4.000	5.250	0.625	102	133	16
21086-2420	53	3.625	4.750	0.500	92	121	13	21086-2546	53	4.000	5.375	0.500	102	137	13
21086-2423	53	3.625	4.875	0.500	92	124	13	21086-2549	53	4.000	5.500	0.500	102	140	13
21086-2424	53	3.625	4.875	0.562	92	124	14	21086-2550	53	4.000	5.500	0.563	102	140	14
21086-2425	53	3.625	4.875	0.625	92	124	16	21086-2551	53	4.000	5.500	0.625	102	140	16
21086-2426	53	3.625	5.000	0.500	92	127	13	21086-2552	53	4.000	5.625	0.500	102	143	13
21086-2429	53	3.625	5.125	0.500	92	130	13	21086-2555	53	4.000	5.750	0.500	102	146	13
21086-2432	53	3.625	5.250	0.500	92	133	13	21086-2556	53	4.000	5.750	0.563	102	146	14
21086-2435	53	3.625	5.375	0.500	92	137	13	21086-2558	53	4.000	5.875	0.500	102	149	13
21086-2438	53	3.625	5.500	0.500	92	140	13	21086-2561	53	4.000	6.000	0.500	102	152	13
21086-2441	53	3.688	4.750	0.500	94	121	13	21086-2564	53	4.000	6.125	0.500	102	156	13
21086-2444	53	3.688	4.875	0.500	94	124	13	21086-2566	53	4.000	6.125	0.625	102	156	16
21086-2447	53	3.688	5.000	0.500	94	127	13	21086-2567	53	4.000	6.250	0.500	102	159	13
21086-2450	53	3.688	5.125	0.500	94	130	13	21086-2570	53	4.063	5.125	0.500	103	130	13
21086-2453	53	3.688	5.250	0.500	94	133	13	21086-2573	53	4.063	5.250	0.500	103	133	13
21086-2459	53	3.688	5.500	0.500	94	140	13	21086-2579	53	4.063	5.500	0.500	103	140	13
21086-2462	53	3.750	4.750	0.500	95	121	13	21086-2588	53	4.063	5.875	0.500	103	149	13
21086-2463	53	3.750	4.750	0.563	95	121	14	21086-2600	53	4.125	5.125	0.500	105	130	13
21086-2464	53	3.750	4.750	0.625	95	121	16	21086-2603	53	4.125	5.250	0.500	105	133	13

All dimensions are in inches. Preferred sizes are indicated with **bold** type face. Sizes listed are for standard nitrile elements, except Models 25 and 62 which have PTFE elements. Other material available on inquiry only.



## Oil Seals by Model Number

Product Code	Model	Inches			MM			Product Code	Model	Inches			MM		
		ID	OD	Width	ID	OD	Width			ID	OD	Width	ID	OD	Width
21086-2604	53	4.125	5.250	0.563	105	133	14	21086-2751	53	4.437	6.250	0.563	113	159	14
21086-2605	53	4.125	5.250	0.625	105	133	16	21086-2753	53	4.500	5.500	0.500	114	140	13
21086-2606	53	4.125	5.375	0.500	105	137	13	21086-2754	53	4.500	5.500	0.563	114	140	14
21086-2608	53	4.125	5.375	0.625	105	137	16	21086-2755	53	4.500	5.500	0.625	114	140	16
21086-2609	53	4.125	5.500	0.500	105	140	13	21086-2756	53	4.500	5.625	0.500	114	143	13
21086-2610	53	4.125	5.500	0.563	105	140	14	21086-2759	53	4.500	5.750	0.500	114	146	13
21086-2612	53	4.125	5.625	0.500	105	143	13	21086-2760	53	4.500	5.750	0.563	114	146	14
21086-2618	53	4.125	5.875	0.500	105	149	13	21086-2761	53	4.500	5.750	0.625	114	146	16
21086-2621	53	4.125	6.000	0.500	105	152	13	21086-2762	53	4.500	5.875	0.500	114	149	13
21086-2630	53	4.188	5.250	0.500	106	133	13	21086-2765	53	4.500	6.000	0.500	114	152	13
21086-2635	53	4.188	5.375	0.625	106	137	16	21086-2766	53	4.500	6.000	0.563	114	152	14
21086-2636	53	4.188	5.500	0.500	106	140	13	21086-2767	53	4.500	6.000	0.625	114	152	16
21086-2637	53	4.187	5.500	0.562	106	140	14	21086-2768	53	4.500	6.125	0.500	114	156	13
21086-2639	53	4.188	5.625	0.500	106	143	13	21086-2771	53	4.500	6.250	0.500	114	159	13
21086-2642	53	4.187	5.750	0.500	106	146	13	21086-2774	53	4.500	6.375	0.500	114	162	13
21086-2645	53	4.188	5.875	0.500	106	149	13	21086-2777	53	4.563	5.625	0.500	116	143	13
21086-2648	53	4.188	6.000	0.500	106	152	13	21086-2780	53	4.563	5.750	0.500	116	146	13
21086-2657	53	4.250	5.250	0.500	108	133	13	21086-2782	53	4.563	5.750	0.625	116	146	16
21086-2659	53	4.250	5.250	0.625	108	133	16	21086-2783	53	4.562	5.875	0.500	116	149	13
21086-2660	53	4.250	5.375	0.500	108	137	13	21086-2786	53	4.563	6.000	0.500	116	152	13
21086-2662	53	4.250	5.375	0.625	108	137	16	21086-2789	53	4.563	6.125	0.500	116	156	13
21086-2663	53	4.250	5.500	0.500	108	140	13	21086-2792	53	4.563	6.250	0.500	116	159	13
21086-2664	53	4.250	5.500	0.563	108	140	14	21086-2798	53	4.625	5.625	0.500	117	143	13
21086-2665	53	4.250	5.500	0.625	108	140	16	21086-2801	53	4.625	5.750	0.500	117	146	13
21086-2666	53	4.250	5.625	0.500	108	143	13	21086-2802	53	4.625	5.750	0.563	117	146	14
21086-2669	53	4.250	5.750	0.500	108	146	13	21086-2804	53	4.625	5.875	0.500	117	149	13
21086-2670	53	4.250	5.750	0.562	108	146	14	21086-2807	53	4.625	6.000	0.500	117	152	13
21086-2671	53	4.250	5.750	0.625	108	146	16	21086-2809	53	4.625	6.000	0.625	117	152	16
21086-2675	53	4.250	6.000	0.500	108	152	13	21086-2810	53	4.625	6.125	0.500	117	156	13
21086-2678	53	4.250	6.125	0.500	108	156	13	21086-2813	53	4.625	6.250	0.500	117	159	13
21086-2684	53	4.313	5.375	0.500	110	137	13	21086-2818	53	4.449	5.512	0.492	113	140	12
21086-2687	53	4.313	5.500	0.500	110	140	13	21086-2819	53	4.688	5.750	0.500	119	146	13
21086-2689	53	4.313	5.500	0.625	110	140	16	21086-2820	53	4.688	5.750	0.563	119	146	14
21086-2690	53	4.313	5.625	0.500	110	143	13	21086-2822	53	4.688	5.875	0.500	119	149	13
21086-2693	53	4.313	5.750	0.500	110	146	13	21086-2825	53	4.688	6.000	0.500	119	152	13
21086-2699	53	4.313	6.000	0.500	110	152	13	21086-2831	53	4.688	6.250	0.500	119	159	13
21086-2705	53	4.313	6.250	0.500	110	159	13	21086-2834	53	4.687	6.375	0.500	119	162	13
21086-2708	53	4.375	5.375	0.500	111	137	13	21086-2837	53	4.750	5.750	0.500	121	146	13
21086-2711	53	4.375	5.500	0.500	111	140	13	21086-2838	53	4.750	5.750	0.563	121	146	14
21086-2712	53	4.375	5.500	0.563	111	140	14	21086-2839	53	4.750	5.750	0.625	121	146	16
21086-2714	53	4.375	5.625	0.500	111	143	13	21086-2840	53	4.750	5.875	0.500	121	149	13
21086-2717	53	4.375	5.750	0.500	111	146	13	21086-2842	53	4.750	5.875	0.625	121	149	16
21086-2720	53	4.375	5.875	0.500	111	149	13	21086-2843	53	4.750	6.000	0.500	121	152	13
21086-2723	53	4.375	6.000	0.500	111	152	13	21086-2845	53	4.750	6.000	0.625	121	152	16
21086-2726	53	4.375	6.125	0.500	111	156	13	21086-2846	53	4.750	6.125	0.500	121	156	13
21086-2729	53	4.375	6.250	0.500	111	159	13	21086-2849	53	4.750	6.250	0.500	121	159	13
21086-2730	53	4.375	6.250	0.563	111	159	14	21086-2852	53	4.750	6.375	0.500	121	162	13
21086-2732	53	4.438	5.500	0.500	113	140	13	21086-2855	53	4.813	5.875	0.500	122	149	13
21086-2733	53	4.437	5.500	0.563	113	140	14	21086-2857	53	4.812	5.875	0.625	122	149	16
21086-2735	53	4.438	5.625	0.500	113	143	13	21086-2858	53	4.813	6.000	0.500	122	152	13
21086-2738	53	4.438	5.750	0.500	113	146	13	21086-2864	53	4.813	6.250	0.500	122	159	13
21086-2739	53	4.437	5.750	0.562	113	146	14	21086-2870	53	4.875	5.875	0.500	124	149	13
21086-2740	53	4.437	5.750	0.625	113	146	16	21086-2873	53	4.875	6.000	0.500	124	152	13
21086-2744	53	4.438	6.000	0.500	113	152	13	21086-2875	53	4.875	6.000	0.625	124	152	16
21086-2747	53	4.438	6.125	0.500	113	156	13	21086-2876	53	4.875	6.125	0.500	124	156	13
21086-2750	53	4.438	6.250	0.500	113	159	13	21086-2878	53	4.875	6.125	0.625	124	156	16

All dimensions are in inches. Preferred sizes are indicated with **bold** type face.

Sizes listed are for standard nitrile elements, except Models 25 and 62 which have PTFE elements. Other material available on inquiry only.

## Oil Seals by Model Number

Product Code	Model	Inches			MM			Product Code	Model	Inches			MM		
		ID	OD	Width	ID	OD	Width			ID	OD	Width	ID	OD	Width
21086-2879	53	4.875	6.250	0.500	124	159	13	21086-3029	53	5.188	6.375	0.500	132	162	13
21086-2881	53	4.875	6.250	0.625	124	159	16	21086-3032	53	5.188	6.500	0.500	132	165	13
21086-2882	53	4.875	6.375	0.500	124	162	13	21086-3034	53	5.188	6.500	0.625	132	165	16
21086-2885	53	4.875	6.500	0.500	124	165	13	21086-3035	53	5.188	6.625	0.500	132	168	13
21086-2888	53	4.875	6.625	0.500	124	168	13	21086-3038	53	5.187	6.750	0.500	132	171	13
21086-2891	53	4.875	6.750	0.500	124	171	13	21086-3044	53	5.188	7.000	0.500	132	178	13
21086-2894	53	4.938	6.000	0.500	125	152	13	21086-3056	53	5.188	7.500	0.500	132	191	13
21086-2896	53	4.938	6.000	0.625	125	152	16	21086-3059	53	5.250	6.250	0.500	133	159	13
21086-2897	53	4.938	6.125	0.500	125	156	13	21086-3062	53	5.250	6.375	0.500	133	162	13
21086-2900	53	4.938	6.250	0.500	125	159	13	21086-3065	53	5.250	6.500	0.500	133	165	13
21086-2901	53	4.938	6.250	0.563	125	159	14	21086-3067	53	5.250	6.500	0.625	133	165	16
21086-2903	53	4.938	6.375	0.500	125	162	13	21086-3071	53	5.250	6.750	0.500	133	171	13
21086-2906	53	4.938	6.500	0.500	125	165	13	21086-3077	53	5.250	7.000	0.500	133	178	13
21086-2908	53	4.938	6.500	0.625	125	165	16	21086-3080	53	5.250	7.125	0.500	133	181	13
21086-2912	53	4.938	6.750	0.500	125	171	13	21086-3092	53	5.313	6.375	0.500	135	162	13
21086-2915	53	5.000	6.000	0.500	127	152	13	21086-3095	53	5.313	6.500	0.500	135	165	13
21086-2916	53	5.000	6.000	0.563	127	152	14	21086-3098	53	5.313	6.625	0.500	135	168	13
21086-2917	53	5.000	6.000	0.625	127	152	16	21086-3101	53	5.313	6.750	0.500	135	171	13
21086-2918	53	5.000	6.125	0.500	127	156	13	21086-3104	53	5.313	6.875	0.500	135	175	13
21086-2921	53	5.000	6.250	0.500	127	159	13	21086-3122	53	5.375	6.375	0.500	137	162	13
21086-2922	53	5.000	6.250	0.563	127	159	14	21086-3125	53	5.375	6.500	0.500	137	165	13
21086-2923	53	5.000	6.250	0.625	127	159	16	21086-3127	53	5.375	6.500	0.625	137	165	16
21086-2924	53	5.000	6.375	0.500	127	162	13	21086-3128	53	5.375	6.625	0.500	137	168	13
21086-2926	53	5.000	6.375	0.625	127	162	16	21086-3129	53	5.375	6.625	0.563	137	168	14
21086-2927	53	5.000	6.500	0.500	127	165	13	21086-3130	53	5.375	6.625	0.625	137	168	16
21086-2929	53	5.000	6.500	0.625	127	165	16	21086-3131	53	5.375	6.750	0.500	137	171	13
21086-2930	53	5.000	6.625	0.500	127	168	13	21086-3136	53	5.375	6.875	0.625	137	175	16
21086-2933	53	5.000	6.750	0.500	127	171	13	21086-3139	53	5.375	7.000	0.625	137	178	16
21086-2935	53	5.000	6.750	0.625	127	171	16	21086-3142	53	5.375	7.125	0.625	137	181	16
21086-2936	53	5.000	6.875	0.500	127	175	13	21086-3151	53	5.375	7.500	0.625	137	191	16
21086-2939	53	5.000	7.000	0.500	127	178	13	21086-3152	53	5.438	6.625	0.500	138	168	13
21086-2941	53	5.000	7.000	0.625	127	178	16	21086-3155	53	5.438	6.750	0.500	138	171	13
21086-2942	53	5.000	7.125	0.500	127	181	13	21086-3158	53	5.438	6.875	0.500	138	175	13
21086-2945	53	5.000	7.250	0.500	127	184	13	21086-3161	53	5.438	7.000	0.500	138	178	13
21086-2948	53	5.000	7.375	0.500	127	187	13	21086-3167	53	5.438	7.250	0.500	138	184	13
21086-2951	53	5.000	7.500	0.500	127	191	13	21086-3176	53	5.500	6.500	0.500	140	165	13
21086-2954	53	5.063	6.125	0.500	129	156	13	21086-3178	53	5.500	6.500	0.625	140	165	16
21086-2957	53	5.062	6.250	0.500	129	159	13	21086-3179	53	5.500	6.625	0.500	140	168	13
21086-2969	53	5.063	6.750	0.500	129	171	13	21086-3182	53	5.500	6.750	0.500	140	171	13
21086-2990	53	5.125	6.125	0.500	130	156	13	21086-3184	53	5.500	6.750	0.625	140	171	16
21086-2992	53	5.125	6.125	0.625	130	156	16	21086-3185	53	5.500	6.875	0.500	140	175	13
21086-2993	53	5.125	6.250	0.500	130	159	13	21086-3188	53	5.500	7.000	0.500	140	178	13
21086-2994	53	5.125	6.250	0.563	130	159	14	21086-3190	53	5.500	7.000	0.625	140	178	16
21086-2996	53	5.125	6.375	0.500	130	162	13	21086-3191	53	5.500	7.125	0.500	140	181	13
21086-2997	53	5.125	6.375	0.563	130	162	14	21086-3194	53	5.500	7.250	0.500	140	184	13
21086-2998	53	5.125	6.375	0.625	130	162	16	21086-3200	53	5.500	7.500	0.500	140	191	13
21086-2999	53	5.125	6.500	0.500	130	165	13	21086-3203	53	5.563	6.625	0.500	141	168	13
21086-3001	53	5.125	6.500	0.625	130	165	16	21086-3208	53	5.563	6.750	0.625	141	171	16
21086-3002	53	5.125	6.625	0.500	130	168	13	21086-3218	53	5.563	7.250	0.500	141	184	13
21086-3005	53	5.125	6.750	0.500	130	171	13	21086-3226	53	5.563	7.500	0.625	141	191	16
21086-3011	53	5.125	7.000	0.500	130	178	13	21086-3228	53	5.625	6.625	0.500	143	168	13
21086-3013	53	5.125	7.000	0.625	130	178	16	21086-3230	53	5.625	6.625	0.625	143	168	16
21086-3017	53	5.125	7.250	0.500	130	184	13	21086-3231	53	5.625	6.750	0.500	143	171	13
21086-3023	53	5.125	7.500	0.500	130	191	13	21086-3234	53	5.625	6.875	0.500	143	175	13
21086-3025	53	5.125	7.500	0.625	130	191	16	21086-3235	53	5.625	6.875	0.563	143	175	14
21086-3026	53	5.188	6.250	0.500	132	159	13	21086-3236	53	5.625	6.875	0.625	143	175	16

All dimensions are in inches. Preferred sizes are indicated with **bold** type face. Sizes listed are for standard nitrile elements, except Models 25 and 62 which have PTFE elements. Other material available on inquiry only.

## Oil Seals by Model Number

Product Code	Model	Inches			MM			Product Code	Model	Inches			MM		
		ID	OD	Width	ID	OD	Width			ID	OD	Width	ID	OD	Width
21086-3237	53	5.625	7.000	0.500	143	178	13	21086-3375	53	6.125	7.125	0.500	156	181	13
21086-3240	53	5.625	7.125	0.500	143	181	13	21086-3377	53	6.125	7.125	0.625	156	181	16
21086-3243	53	5.625	7.250	0.500	143	184	13	21086-3378	53	6.125	7.250	0.500	156	184	13
21086-3245	53	5.625	7.250	0.625	143	184	16	21086-3380	53	6.125	7.250	0.625	156	184	16
21086-3246	53	5.625	7.375	0.500	143	187	13	21086-3381	53	6.125	7.375	0.500	156	187	13
21086-3249	53	5.625	7.500	0.500	143	191	13	21086-3384	53	6.125	7.500	0.500	156	191	13
21086-3253	53	5.688	6.750	0.500	144	171	13	21086-3387	53	6.125	7.500	0.750	156	191	19
21086-3258	53	5.688	6.875	0.625	144	175	16	21086-3388	53	6.250	7.250	0.500	159	184	13
21086-3259	53	5.688	7.000	0.500	144	178	13	21086-3391	53	6.250	7.375	0.500	159	187	13
21086-3268	53	5.688	7.375	0.500	144	187	13	21086-3394	53	6.250	7.500	0.500	159	191	13
21086-3270	53	5.688	7.375	0.625	144	187	16	21086-3395	53	6.250	7.500	0.563	159	191	14
21086-3271	53	5.688	7.500	0.500	144	191	13	21086-3396	53	6.250	7.500	0.625	159	191	16
21086-3275	53	5.750	6.750	0.500	146	171	13	21086-3397	53	6.250	7.500	0.750	159	191	19
21086-3276	53	5.750	6.750	0.563	146	171	14	21086-3398	53	6.250	7.625	0.500	159	194	13
21086-3278	53	5.750	6.875	0.500	146	175	13	21086-3402	53	6.250	7.750	0.500	159	197	13
21086-3281	53	5.750	7.000	0.500	146	178	13	21086-3405	53	6.250	7.750	0.750	159	197	19
21086-3282	53	5.750	7.000	0.563	146	178	14	21086-3406	53	6.375	7.375	0.500	162	187	13
21086-3283	53	5.750	7.000	0.625	146	178	16	21086-3409	53	6.375	7.500	0.500	162	191	13
21086-3284	53	5.750	7.125	0.500	146	181	13	21086-3413	53	6.375	7.625	0.500	162	194	13
21086-3287	53	5.750	7.250	0.500	146	184	13	21086-3415	53	6.375	7.625	0.625	162	194	16
21086-3289	53	5.750	7.250	0.625	146	184	16	21086-3417	53	6.375	7.750	0.500	162	197	13
21086-3290	53	5.750	7.375	0.500	146	187	13	21086-3421	53	6.375	7.875	0.500	162	200	13
21086-3293	53	5.750	7.500	0.500	146	191	13	21086-3424	53	6.375	7.875	0.750	162	200	19
21086-3297	53	5.813	6.875	0.500	148	175	13	21086-3425	53	6.438	7.750	0.750	164	197	19
21086-3300	53	5.813	7.000	0.500	148	178	13	21086-3426	53	6.500	7.500	0.625	165	191	16
21086-3305	53	5.813	7.125	0.500	148	181	13	21086-3428	53	6.500	7.625	0.625	165	194	16
21086-3309	53	5.812	7.375	0.500	148	187	13	21086-3430	53	6.500	7.750	0.625	165	197	16
21086-3312	53	5.812	7.500	0.500	148	191	13	21086-3432	53	6.500	7.875	0.625	165	200	16
21086-3316	53	5.875	6.875	0.500	149	175	13	21086-3434	53	6.500	8.000	0.625	165	203	16
21086-3319	53	5.875	7.000	0.500	149	178	13	21086-3435	53	6.500	8.000	0.750	165	203	19
21086-3322	53	5.875	7.125	0.500	149	181	13	21086-3436	53	6.625	7.625	0.625	168	194	16
21086-3324	53	5.875	7.125	0.625	149	181	16	21086-3438	53	6.625	7.750	0.625	168	197	16
21086-3325	53	5.875	7.250	0.500	149	184	13	21086-3440	53	6.625	7.875	0.625	168	200	16
21086-3328	53	5.875	7.375	0.500	149	187	13	21086-3442	53	6.625	8.000	0.625	168	203	16
21086-3331	53	5.875	7.500	0.500	149	191	13	21086-3444	53	6.625	8.125	0.625	168	206	16
21086-3335	53	5.938	7.000	0.500	151	178	13	21086-3445	53	6.625	8.125	0.750	168	206	19
21086-3338	53	5.938	7.125	0.500	151	181	13	21086-3446	53	6.625	8.250	0.625	168	210	16
21086-3343	53	5.938	7.250	0.625	151	184	16	21086-3447	53	6.625	8.250	0.750	168	210	19
21086-3344	53	5.938	7.375	0.500	151	187	13	21086-3448	53	6.625	8.375	0.625	168	213	16
21086-3347	53	5.938	7.500	0.500	151	191	13	21086-3450	53	6.625	8.500	0.625	168	216	16
21086-3351	53	5.938	7.625	0.500	151	194	13	21086-3454	53	6.625	8.750	0.625	168	222	16
21086-3355	53	6.000	7.000	0.500	152	178	13	21086-3456	53	6.750	7.750	0.625	171	197	16
21086-3356	53	6.000	7.000	0.563	152	178	14	21086-3458	53	6.750	7.875	0.625	171	200	16
21086-3357	53	6.000	7.000	0.625	152	178	16	21086-3460	53	6.750	8.000	0.625	171	203	16
21086-3358	53	6.000	7.125	0.500	152	181	13	21086-3462	53	6.750	8.125	0.625	171	206	16
21086-3359	53	6.000	7.125	0.563	152	181	14	21086-3464	53	6.750	8.250	0.625	171	210	16
21086-3360	53	6.000	7.125	0.625	152	181	16	21086-3465	53	6.750	8.250	0.750	171	210	19
21086-3361	53	6.000	7.250	0.500	152	184	13	21086-3466	53	6.750	8.375	0.625	171	213	16
21086-3363	53	6.000	7.250	0.625	152	184	16	21086-3468	53	6.750	8.500	0.625	171	216	16
21086-3364	53	6.000	7.375	0.500	152	187	13	21086-3472	53	6.750	8.750	0.625	171	222	16
21086-3367	53	6.000	7.500	0.500	152	191	13	21086-3474	53	6.875	7.875	0.625	175	200	16
21086-3369	53	6.000	7.500	0.625	152	191	16	21086-3476	53	6.875	8.000	0.625	175	203	16
21086-3370	53	6.000	7.500	0.750	152	191	19	21086-3478	53	6.875	8.125	0.625	175	206	16
21086-3371	53	6.000	7.625	0.500	152	194	13	21086-3480	53	6.875	8.250	0.625	175	210	16
21086-3372	53	6.000	7.625	0.563	152	194	14	21086-3482	53	6.875	8.375	0.625	175	213	16
21086-3374	53	6.000	7.625	0.750	152	194	19	21086-3483	53	6.875	8.375	0.750	175	213	19

All dimensions are in inches. Preferred sizes are indicated with **bold** type face.

Sizes listed are for standard nitrile elements, except Models 25 and 62 which have PTFE elements. Other material available on inquiry only.

## Oil Seals by Model Number

Product Code	Model	Inches			MM			Product Code	Model	Inches			MM		
		ID	OD	Width	ID	OD	Width			ID	OD	Width	ID	OD	Width
21086-3484	53	6.875	8.500	0.625	175	216	16	21086-3584	53	7.875	9.125	0.625	200	232	16
21086-3485	53	6.875	8.500	0.750	175	216	19	21086-3586	53	7.875	9.250	0.625	200	235	16
21086-3488	53	6.875	8.750	0.625	175	222	16	21086-3588	53	7.875	9.375	0.625	200	238	16
21086-3492	53	7.000	8.000	0.625	178	203	16	21086-3589	53	7.875	9.375	0.750	200	238	19
21086-3494	53	7.000	8.125	0.625	178	206	16	21086-3590	53	7.938	9.125	0.625	202	232	16
21086-3495	53	7.000	8.125	0.750	178	206	19	21086-3592	53	8.000	9.000	0.625	203	229	16
21086-3496	53	7.000	8.250	0.625	178	210	16	21086-3593	53	8.000	9.000	0.750	203	229	19
21086-3498	53	7.000	8.375	0.625	178	213	16	21086-3594	53	8.000	9.125	0.625	203	232	16
21086-3500	53	7.000	8.500	0.625	178	216	16	21086-3596	53	8.000	9.250	0.625	203	235	16
21086-3501	53	7.000	8.500	0.750	178	216	19	21086-3597	53	8.000	9.250	0.750	203	235	19
21086-3504	53	7.000	8.750	0.625	178	222	16	21086-3598	53	8.000	9.375	0.625	203	238	16
21086-3506	53	7.125	8.125	0.625	181	206	16	21086-3600	53	8.000	9.500	0.625	203	241	16
21086-3508	53	7.125	8.250	0.625	181	210	16	21086-3601	53	8.000	9.500	0.750	203	241	19
21086-3510	53	7.125	8.375	0.625	181	213	16	21086-3602	53	8.000	10.000	1.000	203	254	25
21086-3512	53	7.125	8.500	0.625	181	216	16	21086-3603	53	8.125	10.000	1.000	206	254	25
21086-3514	53	7.125	8.625	0.625	181	219	16	21086-3604	53	8.250	9.250	0.625	210	235	16
21086-3515	53	7.125	8.625	0.750	181	219	19	21086-3605	53	8.250	9.375	0.625	210	238	16
21086-3516	53	7.125	8.750	0.625	181	222	16	21086-3606	53	8.250	9.500	0.625	210	241	16
21086-3518	53	7.250	8.250	0.625	184	210	16	21086-3607	53	8.250	10.250	1.000	210	260	25
21086-3520	53	7.250	8.375	0.625	184	213	16	21086-3608	53	8.375	9.750	0.750	213	248	19
21086-3522	53	7.250	8.500	0.625	184	216	16	21086-3609	53	8.375	10.375	1.000	213	264	25
21086-3524	53	7.250	8.625	0.625	184	219	16	21086-3610	53	8.500	10.500	1.000	216	267	25
21086-3526	53	7.250	8.750	0.625	184	222	16	21086-3611	53	8.625	10.625	0.750	219	270	19
21086-3527	53	7.250	8.750	0.750	184	222	19	21086-3612	53	8.625	10.750	1.000	219	273	25
21086-3528	53	7.375	8.375	0.625	187	213	16	21086-3613	53	8.750	10.750	1.000	222	273	25
21086-3530	53	7.375	8.500	0.625	187	216	16	21086-3615	53	9.000	10.000	0.750	229	254	19
21086-3532	53	7.375	8.625	0.625	187	219	16	21086-3616	53	9.000	10.125	0.750	229	257	19
21086-3534	53	7.375	8.750	0.625	187	222	16	21086-3617	53	9.000	10.250	0.750	229	260	19
21086-3536	53	7.375	8.875	0.625	187	225	16	21086-3619	53	9.000	10.500	0.750	229	267	19
21086-3538	53	7.375	9.000	0.625	187	229	16	21086-3621	53	9.000	10.750	0.750	229	273	19
21086-3540	53	7.375	9.125	0.625	187	232	16	21086-3622	53	9.000	10.875	0.750	229	276	19
21086-3542	53	7.375	9.250	0.625	187	235	16	21086-3623	53	9.000	11.000	0.750	229	279	19
21086-3544	53	7.500	8.500	0.625	191	216	16	21086-3624	53	9.000	11.000	1.000	229	279	25
21086-3546	53	7.500	8.625	0.625	191	219	16	21086-3628	53	9.250	10.250	0.750	235	260	19
21086-3548	53	7.500	8.750	0.625	191	222	16	21086-3629	53	9.250	10.375	0.750	235	264	19
21086-3550	53	7.500	8.875	0.625	191	225	16	21086-3630	53	9.250	10.500	0.750	235	267	19
21086-3552	53	7.500	9.000	0.625	191	229	16	21086-3632	53	9.250	10.750	0.750	235	273	19
21086-3553	53	7.500	9.000	0.750	191	229	19	21086-3633	53	9.250	11.250	1.000	235	286	25
21086-3554	53	7.500	9.125	0.625	191	232	16	21086-3634	53	9.375	11.375	1.000	238	289	25
21086-3555	53	7.500	9.125	0.750	191	232	19	21086-3635	53	9.437	10.500	0.750	240	267	19
21086-3556	53	7.500	9.250	0.625	191	235	16	21086-3636	53	9.438	10.625	0.750	240	270	19
21086-3558	53	7.625	8.625	0.625	194	219	16	21086-3638	53	9.500	10.500	0.625	241	267	16
21086-3560	53	7.625	8.750	0.625	194	222	16	21086-3639	53	9.500	10.625	0.625	241	270	16
21086-3562	53	7.625	8.875	0.625	194	225	16	21086-3640	53	9.500	10.750	0.625	241	273	16
21086-3564	53	7.625	9.000	0.625	194	229	16	21086-3642	53	9.500	11.000	0.625	241	279	16
21086-3566	53	7.625	9.125	0.625	194	232	16	21086-3643	53	9.500	11.125	0.625	241	283	16
21086-3567	53	7.625	9.125	0.750	194	232	19	21086-3644	53	9.500	11.250	0.625	241	286	16
21086-3568	53	7.625	9.250	0.625	194	235	16	21086-3646	53	9.500	11.500	0.625	241	292	16
21086-3570	53	7.750	8.750	0.625	197	222	16	21086-3648	53	9.500	11.500	1.000	241	292	25
21086-3572	53	7.750	8.875	0.625	197	225	16	21086-3649	53	9.625	11.625	1.000	244	295	25
21086-3574	53	7.750	9.000	0.625	197	229	16	21086-3650	53	9.750	10.750	0.750	248	273	19
21086-3576	53	7.750	9.125	0.625	197	232	16	21086-3652	53	9.750	11.000	0.750	248	279	19
21086-3578	53	7.750	9.250	0.625	197	235	16	21086-3653	53	9.750	11.125	0.750	248	283	19
21086-3579	53	7.750	9.250	0.750	197	235	19	21086-3654	53	9.750	11.250	0.750	248	286	19
21086-3580	53	7.875	8.875	0.625	200	225	16	21086-3655	53	9.750	11.750	1.000	248	298	25
21086-3582	53	7.875	9.000	0.625	200	229	16	21086-3658	53	9.937	12.000	1.000	252	305	25

All dimensions are in inches. Preferred sizes are indicated with **bold** type face. Sizes listed are for standard nitrile elements, except Models 25 and 62 which have PTFE elements. Other material available on inquiry only.

## Oil Seals by Model Number

Product Code	Model	Inches			MM			Product Code	Model	Inches			MM		
		ID	OD	Width	ID	OD	Width			ID	OD	Width	ID	OD	Width
21086-3660	53	10.000	11.000	0.563	254	279	14	21086-3736	53-L	16.000	18.000	1.000	406	457	25
21086-3661	53	10.000	11.125	0.563	254	283	14	21086-3737	53-L	16.250	18.000	1.000	413	457	25
21086-3662	53	10.000	11.250	0.563	254	286	14	21086-3738	53-L	16.500	18.500	1.000	419	470	25
21086-3663	53	10.000	11.375	0.563	254	289	14	21086-3741	53-L	18.000	19.500	0.750	457	495	19
21086-3664	53	10.000	11.500	0.563	254	292	14	21086-3742	53-L	18.000	20.000	1.000	457	508	25
21086-3666	53	10.000	11.750	0.563	254	298	14	21086-3749	53-L	20.000	22.000	1.000	508	559	25
21086-3667	53	10.000	11.875	0.563	254	302	14	21086-3781	53-L	27.000	29.000	1.000	686	737	25
21086-3668	53	10.000	11.000	0.750	254	279	19	21086-3787	53	3.938	5.512	0.472	100	140	12
21086-3670	53	10.000	11.250	0.750	254	286	19	21086-3793	53	4.252	5.866	0.472	108	149	12
21086-3671	53	10.000	11.375	0.750	254	289	19	21086-3844	53-L	36.000	38.500	1.000	914	978	25
21086-3672	53	10.000	11.500	0.750	254	292	19	21086-3917	53	6.438	7.500	0.500	164	191	13
21086-3673	53	10.000	12.000	1.000	254	305	25	21086-3918	53	6.688	7.750	0.625	170	197	16
21086-3674	53	10.125	12.000	1.000	257	305	25	21086-3922	53	8.000	9.750	0.750	203	248	19
21086-3675	53	10.188	12.250	1.000	259	311	25	21086-3924	53	8.000	10.000	0.688	203	254	17
21086-3676	53	10.250	12.250	0.750	260	311	19	21086-3925	53	8.000	10.000	0.750	203	254	19
21086-3677	53	10.250	12.250	1.000	260	311	25	21086-3932	53	8.125	10.125	0.750	206	257	19
21086-3678	53	10.438	12.500	1.000	265	318	25	21086-3933	53	8.375	9.875	0.688	213	251	17
21086-3680	53	10.500	12.500	1.000	267	318	25	21086-3934	53	8.375	9.875	0.750	213	251	19
21086-3681	53	10.500	12.625	1.000	267	321	25	21086-3935	53	8.500	9.500	0.625	216	241	16
21086-3682	53	10.750	11.750	0.563	273	298	14	21086-3937	53	8.500	10.000	0.750	216	254	19
21086-3684	53	10.750	12.000	0.563	273	305	14	21086-3939	53	8.625	10.125	0.688	219	257	17
21086-3685	53	10.750	12.250	0.563	273	311	14	21086-3940	53	8.625	10.125	0.750	219	257	19
21086-3686	53	10.750	12.500	0.563	273	318	14	21086-3941	53	8.625	10.250	0.750	219	260	19
21086-3687	53	10.750	12.750	0.563	273	324	14	21086-3943	53	8.625	10.500	0.750	219	267	19
21086-3688	53	10.750	12.750	0.875	273	324	22	21086-3945	53	8.625	10.625	1.000	219	270	25
21086-3689	53	10.750	12.750	1.000	273	324	25	21086-3946	53	8.750	10.250	0.688	222	260	17
21086-3691	53	11.000	12.000	0.625	279	305	16	21086-3947	53	8.750	10.250	0.750	222	260	19
21086-3692	53	11.000	12.250	0.625	279	311	16	21086-3948	53	8.750	10.375	0.750	222	264	19
21086-3693	53	11.000	12.500	0.625	279	318	16	21086-3949	53	8.750	10.500	0.750	222	267	19
21086-3694	53	11.000	13.000	1.000	279	330	25	21086-3950	53	8.750	10.625	0.750	222	270	19
21086-3695	53	11.063	12.250	0.750	281	311	19	21086-3951	53	8.750	10.750	0.750	222	273	19
21086-3696	53	11.062	12.500	0.750	281	318	19	21086-3954	53	9.000	10.500	0.688	229	267	17
21086-3697	53	11.063	12.750	0.750	281	324	19	21086-3958	53	9.125	10.625	0.750	232	270	19
21086-3698	53	11.062	13.000	0.750	281	330	19	21086-3959	53	9.125	10.750	0.750	232	273	19
21086-3703	53	11.250	13.250	1.000	286	337	25	21086-3961	53	9.125	11.000	0.750	232	279	19
21086-3704	53	11.375	13.500	1.000	289	343	25	21086-3963	53	9.250	10.750	0.688	235	273	17
21086-3705	53	11.500	13.500	1.000	292	343	25	21086-3964	53	9.250	10.875	0.750	235	276	19
21086-3706	53	11.750	13.750	1.000	298	349	25	21086-3965	53	9.250	11.000	0.750	235	279	19
21086-3707	53-L	11.750	14.000	1.000	298	356	25	21086-3967	53	9.250	11.250	0.750	235	286	19
21086-3709	53-L	12.000	14.000	1.000	305	356	25	21086-3972	53	9.375	11.000	0.750	238	279	19
21086-3710	53-L	12.000	14.250	1.000	305	362	25	21086-3975	53	9.375	11.375	0.750	238	289	19
21086-3713	53-L	12.250	14.250	1.000	311	362	25	21086-3977	53	9.437	10.500	0.625	240	267	16
21086-3714	53-L	12.500	14.500	1.000	318	368	25	21086-3981	53	9.500	11.250	0.750	241	286	19
21086-3715	53-L	12.625	14.625	1.000	321	371	25	21086-3989	53	9.750	11.750	0.750	248	298	19
21086-3717	53-L	12.688	14.750	1.000	322	375	25	21086-3990	53	9.875	11.375	0.750	251	289	19
21086-3718	53-L	12.875	14.750	1.000	327	375	25	21086-3991	53	9.875	11.500	0.750	251	292	19
21086-3719	53-L	13.000	15.000	1.000	330	381	25	21086-3992	53	10.000	11.500	0.688	254	292	17
21086-3721	53-L	13.500	15.500	1.000	343	394	25	21086-3993	53	10.000	11.625	0.750	254	295	19
21086-3722	53-L	13.750	15.750	1.000	349	400	25	21086-3994	53	10.000	11.750	0.750	254	298	19
21086-3725	53-L	14.000	16.000	1.000	356	406	25	21086-3996	53	10.000	12.000	0.750	254	305	19
21086-3726	53-L	14.000	16.250	1.000	356	413	25	21086-3998	53	10.000	12.000	0.875	254	305	22
21086-3727	53-L	14.000	16.500	1.000	356	419	25	21086-3999	53	10.125	11.625	0.688	257	295	17
21086-3728	53-L	14.500	16.500	0.750	368	419	19	21086-4000	53	10.125	11.625	0.750	257	295	19
21086-3730	53-L	15.000	17.000	0.875	381	432	22	21086-4003	53	10.125	12.000	0.750	257	305	19
21086-3731	53-L	15.000	17.000	1.000	381	432	25	21086-4004	53	10.250	11.750	0.688	260	298	17
21086-3734	53-L	15.250	17.250	0.875	387	438	22	21086-4005	53	10.250	11.750	0.750	260	298	19

All dimensions are in inches. Preferred sizes are indicated with **bold** type face.

Sizes listed are for standard nitrile elements, except Models 25 and 62 which have PTFE elements. Other material available on inquiry only.

## Oil Seals by Model Number

Product Code	Model	Inches			MM			Product Code	Model	Inches			MM		
		ID	OD	Width	ID	OD	Width			ID	OD	Width	ID	OD	Width
21086-4007	53	10.250	12.000	0.750	260	305	19	21086-4154	53-L	15.000	16.875	0.750	381	429	19
21086-4010	53	10.375	12.197	1.000	264	310	25	21086-4155	53-L	15.000	17.000	0.750	381	432	19
21086-4011	53	10.500	12.000	0.688	267	305	17	21086-4157	53-L	15.250	17.250	1.000	387	438	25
21086-4012	53	10.500	12.000	0.750	267	305	19	21086-4160	53-L	15.375	17.375	1.000	391	441	25
21086-4013	53	10.500	12.125	0.750	267	308	19	21086-4177	53-L	16.000	17.500	0.688	406	445	17
21086-4014	53	10.500	12.250	0.750	267	311	19	21086-4178	53-L	16.000	17.500	0.688	406	445	17
21086-4016	53	10.500	12.500	0.750	267	318	19	21086-4181	53-L	16.250	17.750	0.688	413	451	17
21086-4018	53	10.625	12.125	0.750	270	308	19	21086-4182	53-L	16.250	17.750	0.750	413	451	19
21086-4019	53	10.625	12.250	0.750	270	311	19	21086-4184	53-L	16.250	18.000	0.750	413	457	19
21086-4020	53	10.625	12.375	0.750	270	314	19	21086-4185	53-L	16.500	18.000	0.750	419	457	19
21086-4021	53	10.625	12.500	0.750	270	318	19	21086-4192	53-L	17.250	19.250	0.938	438	489	24
21086-4024	53	10.750	12.250	0.750	273	311	19	21086-4194	53-L	17.500	19.000	0.688	445	483	17
21086-4025	53	10.750	12.375	0.562	273	314	14	21086-4195	53-L	17.500	19.000	0.750	445	483	19
21086-4029	53	10.750	12.625	0.750	273	321	19	21086-4196	53-L	17.500	19.250	0.750	445	489	19
21086-4030	53	10.750	12.750	0.750	273	324	19	21086-4201	53-L	17.750	19.750	1.000	451	502	25
21086-4046	53	11.250	12.750	0.750	286	324	19	21086-4202	53-L	17.750	20.089	1.000	451	510	25
21086-4048	53	11.250	13.500	1.000	286	343	25	21086-4206	53-L	18.000	19.500	0.688	457	495	17
21086-4050	53	11.378	12.874	0.748	289	327	19	21086-4249	53-L	20.750	22.750	1.000	527	578	25
21086-4051	53	11.375	13.000	0.750	289	330	19	21086-4264	53-L	21.625	23.625	1.000	549	600	25
21086-4057	53	11.500	13.000	0.688	292	330	17	21086-4289	53-L	23.500	25.500	1.000	597	648	25
21086-4058	53	11.500	13.000	0.750	292	330	19	21086-4477	53	6.938	8.125	0.625	176	206	16
21086-4060	53	11.500	13.250	0.750	292	337	19	21086-4478	53	6.938	8.375	0.625	176	213	16
21086-4062	53	11.500	13.500	0.750	292	343	19	21086-4479	53	6.937	8.500	0.625	176	216	16
21086-4064	53	11.750	13.250	0.688	298	337	17	21086-4490	53	6.063	7.500	0.500	154	191	13
21086-4065	53	11.750	13.250	0.750	298	337	19	21086-4492	53	7.313	8.375	0.625	186	213	16
21086-4067	53	12.000	13.500	0.750	305	343	19	21086-4501	53	8.438	10.000	0.625	214	254	16
21086-4068	53	12.000	13.625	0.750	305	346	19	21086-4502	53	8.500	10.000	0.625	216	254	16
21086-4071	53-L	12.000	14.000	0.750	305	356	19	21086-4503	53	9.000	10.000	0.625	229	254	16
21086-4073	53-L	12.125	14.000	1.000	308	356	25	21086-4504	53	9.000	10.125	0.625	229	257	16
21086-4074	53	12.250	13.750	0.750	311	349	19	21086-4505	53	9.000	10.250	0.625	229	260	16
21086-4077	53	12.375	13.875	0.750	314	352	19	21086-4506	53	9.000	10.375	0.625	229	264	16
21086-4080	53-L	12.500	14.000	0.750	318	356	19	21086-4507	53	9.000	10.500	0.625	229	267	16
21086-4085	53-L	12.500	14.750	1.000	318	375	25	21086-4508	53	9.000	10.625	0.625	229	270	16
21086-4093	53-L	13.000	14.500	0.688	330	368	17	21086-4509	53	9.250	10.250	0.625	235	260	16
21086-4094	53-L	13.000	14.500	0.750	330	368	19	21086-4511	53	9.250	10.500	0.625	235	267	16
21086-4095	53-L	13.000	14.625	0.750	330	371	19	21086-4512	53	9.625	10.875	0.750	244	276	19
21086-4098	53-L	13.000	15.000	0.750	330	381	19	21086-4513	53	9.750	10.750	0.625	248	273	16
21086-4101	53-L	13.250	14.750	0.688	337	375	17	21086-4514	53	9.750	10.875	0.625	248	276	16
21086-4102	53-L	13.250	14.750	0.750	337	375	19	21086-4515	53	9.750	11.000	0.625	248	279	16
21086-4103	53-L	13.250	14.875	0.750	337	378	19	21086-4516	53	9.750	11.125	0.625	248	283	16
21086-4107	53-L	13.250	15.250	1.000	337	387	25	21086-4517	53	9.750	11.250	0.625	248	286	16
21086-4109	53-L	13.250	15.375	1.000	337	391	25	21086-4519	53	10.750	11.875	0.625	273	302	16
21086-4113	53-L	13.250	15.500	1.000	337	394	25	21086-4520	53	10.750	12.000	0.625	273	305	16
21086-4121	53-L	13.504	15.000	0.709	343	381	18	21086-4522	53	10.750	12.250	0.625	273	311	16
21086-4122	53-L	13.504	15.000	0.748	343	381	19	21086-4524	53	10.750	12.500	0.625	273	318	16
21086-4125	53-L	13.500	15.375	0.750	343	391	19	21086-4527	53	11.250	12.750	0.688	286	324	17
21086-4127	53-L	13.500	15.500	0.750	343	394	19	21086-4529	53-L	13.750	15.250	0.688	349	387	17
21086-4132	53-L	14.000	15.500	0.750	356	394	19	21086-4530	53-L	13.750	15.250	0.750	349	387	19
21086-4133	53-L	14.000	15.563	0.750	356	395	19	21086-4531	53-L	13.750	15.500	0.750	349	394	19
21086-4134	53-L	14.000	15.750	0.750	356	400	19	21086-4546	53	3.000	4.500	0.563	76	114	14
21086-4142	53-L	14.500	16.000	0.688	368	406	17	21086-4561	53	7.125	8.125	0.500	181	206	13
21086-4144	53-L	14.500	16.250	0.750	368	413	19	21086-4587	53	8.500	10.625	0.750	216	270	19
21086-4150	53-L	14.875	16.875	1.000	378	429	25	21086-4729	53	6.125	7.625	0.750	156	194	19
21086-4151	53-L	15.000	16.500	0.688	381	419	17	21086-4817	53	3.938	4.938	0.500	100	125	13
21086-4152	53-L	15.000	16.500	0.750	381	419	19	21086-4834	53	7.874	9.055	0.500	200	230	13
21086-4153	53-L	15.000	16.750	0.750	381	425	19	21086-5115	53	7.500	8.464	0.625	191	215	16

All dimensions are in inches. Preferred sizes are indicated with **bold** type face.  
 Sizes listed are for standard nitrile elements, except Models 25 and 62 which have PTFE elements. Other material available on inquiry only.

## Oil Seals by Model Number

Product Code	Model	Inches			MM			Product Code	Model	Inches			MM		
		ID	OD	Width	ID	OD	Width			ID	OD	Width	ID	OD	Width
21086-5277	53-L	15.000	17.250	0.875	381	438	22	21086-8429	53	3.543	4.724	0.500	90	120	13
21086-5357	53	8.661	9.842	0.590	220	250	15	21086-8877	53	3.500	4.921	0.562	89	125	14
21086-5359	53	9.448	10.629	0.590	240	270	15	21086-9724	53	3.000	4.250	0.625	76	108	16
21086-5582	53	3.625	5.000	0.563	92	127	14	21086-9780	53	6.500	7.500	0.563	165	191	14
21086-5677	53	6.625	7.875	0.500	168	200	13	21087-2177	53	3.000	4.125	0.500	76	105	13
21086-5906	53	10.000	12.000	0.688	254	305	17	21087-2249	53	3.188	4.249	0.500	81	108	13
21086-5987	53-L	14.563	16.000	0.625	370	406	16	21087-2270	53	3.250	4.249	0.500	83	108	13
21086-6381	53	8.000	9.625	0.750	203	244	19	21087-2277	53	3.250	4.500	0.563	83	114	14
21086-6386	53	8.750	10.000	0.625	222	254	16	21087-2324	53	3.375	4.500	0.500	86	114	13
21086-6435	53	3.000	4.331	0.500	76	110	13	21087-2345	53	3.438	4.500	0.500	87	114	13
21086-6501	53	6.500	8.125	0.625	165	206	16	21087-2366	53	3.500	4.500	0.500	89	114	13
21086-6602	53	6.125	7.625	0.625	156	194	16	21087-2372	53	3.500	4.750	0.500	89	121	13
21086-6697	53-L	16.500	18.500	0.750	419	470	19	21087-2378	53	3.500	4.999	0.500	89	127	13
21086-6817	53	6.500	7.750	0.500	165	197	13	21087-2387	53	3.500	5.375	0.500	89	137	13
21086-6903	53	3.313	4.331	0.500	84	110	13	21087-2423	53	3.625	4.875	0.500	92	124	13
21086-7101	53	8.500	10.500	0.750	216	267	19	21087-2426	53	3.625	5.000	0.500	92	127	13
21086-7253	53	3.500	5.000	0.500	89	127	13	21087-2462	53	3.750	4.750	0.500	95	121	13
21086-7267	53	5.512	6.693	0.591	140	170	15	21087-2471	53	3.750	5.125	0.500	95	130	13
21086-7268	53	6.693	7.875	0.591	170	200	15	21087-2516	53	3.875	5.500	0.500	98	140	13
21086-7271	53	4.528	5.512	0.472	115	140	12	21087-2519	53	3.938	4.999	0.500	100	127	13
21086-7276	53	6.299	7.480	0.591	160	190	15	21087-2525	53	3.938	5.250	0.500	100	133	13
21086-7277	53	4.724	5.906	0.591	120	150	15	21087-2537	53	4.000	4.999	0.500	102	127	13
21086-7376	53	4.724	5.906	0.472	120	150	12	21087-2540	53	4.000	5.125	0.500	102	130	13
21086-7383	53	5.512	6.693	0.551	140	170	14	21087-2630	53	4.188	5.250	0.500	106	133	13
21086-7388	53	7.875	9.055	0.591	200	230	15	21087-2657	53	4.250	5.250	0.500	108	133	13
21086-7394	53	3.346	4.724	0.472	85	120	12	21087-2708	53	4.375	5.375	0.500	111	137	13
21086-7396	53	4.331	5.512	0.472	110	140	12	21087-2753	53	4.500	5.500	0.500	114	140	13
21086-7399	53	3.346	4.921	0.472	85	125	12	21087-2765	53	4.500	6.000	0.500	114	152	13
21086-7426	53	3.150	4.331	0.472	80	110	12	21087-2819	53	4.688	5.750	0.500	119	146	13
21086-7447	53	9.438	10.625	0.625	240	270	16	21087-2822	53	4.688	5.875	0.500	119	149	13
21086-7495	53	6.889	8.465	0.629	175	215	16	21087-2840	53	4.750	5.875	0.500	121	149	13
21086-7664	53-L	18.000	20.250	1.000	457	514	25	21087-2870	53	4.875	5.875	0.500	124	149	13
21086-7807	53	7.087	8.267	0.591	180	210	15	21087-2873	53	4.875	6.000	0.500	124	152	13
21086-7836	53	4.724	6.299	0.472	120	160	12	21087-2894	53	4.938	6.000	0.500	125	152	13
21086-7839	53	3.543	4.724	0.472	90	120	12	21087-2900	53	4.938	6.250	0.500	125	159	13
21086-7842	53	3.938	5.118	0.472	100	130	12	21087-2915	53	5.000	6.000	0.500	127	152	13
21086-7848	53	11.024	12.598	0.630	280	320	16	21087-2918	53	5.000	6.125	0.500	127	156	13
21086-7849	53-L	14.173	15.748	0.630	360	400	16	21087-2922	53	5.000	6.250	0.563	127	159	14
21086-7868	53	3.375	4.724	0.500	86	120	13	21087-2923	53	5.000	6.250	0.625	127	159	16
21086-7887	53	8.267	9.842	0.551	210	250	14	21087-2957	53	5.062	6.250	0.500	129	159	13
21086-7890	53	9.055	10.630	0.551	230	270	14	21087-2990	53	5.125	6.125	0.500	130	156	13
21086-7891	53	9.448	11.023	0.629	240	280	16	21087-2997	53	5.125	6.375	0.563	130	162	14
21086-7892	53	11.811	13.386	0.630	300	340	16	21087-3059	53	5.250	6.250	0.500	133	159	13
21086-7893	53	11.811	13.386	0.629	300	340	16	21087-3176	53	5.500	6.500	0.500	140	165	13
21086-7896	53-L	13.386	14.961	0.630	340	380	16	21087-3228	53	5.625	6.625	0.500	143	168	13
21086-7942	53	3.000	4.724	0.500	76	120	13	21087-3231	53	5.625	6.750	0.500	143	171	13
21086-7945	53	3.062	4.724	0.500	78	120	13	21087-3275	53	5.750	6.750	0.500	146	171	13
21086-7950	53	3.187	4.331	0.500	81	110	13	21087-3316	53	5.875	6.875	0.500	149	175	13
21086-7953	53	3.250	4.724	0.500	83	120	13	21087-3367	53	6.000	7.500	0.500	152	191	13
21086-7955	53	3.250	5.118	0.500	83	130	13	21087-3378	53	6.125	7.250	0.500	156	184	13
21086-7960	53	3.438	4.724	0.500	87	120	13	21087-3388	53	6.250	7.250	0.500	159	184	13
21086-7968	53	3.625	4.724	0.500	92	120	13	21087-3394	53	6.250	7.500	0.500	159	191	13
21086-7979	53	3.938	5.118	0.500	100	130	13	21087-3436	53	6.625	7.625	0.625	168	194	16
21086-7980	53	4.000	5.118	0.500	102	130	13	21087-3444	53	6.625	8.125	0.625	168	206	16
21086-8049	53	7.480	8.661	0.591	190	220	15	21087-3456	53	6.750	7.750	0.625	171	197	16
21086-8121	53	3.187	4.724	0.500	81	120	13	21087-3468	53	6.750	8.500	0.625	171	216	16

All dimensions are in inches. Preferred sizes are indicated with **bold** type face.

Sizes listed are for standard nitrile elements, except Models 25 and 62 which have PTFE elements. Other material available on inquiry only.

## Oil Seals by Model Number

Product Code	Model	Inches			MM			Product Code	Model	Inches			MM		
		ID	OD	Width	ID	OD	Width			ID	OD	Width	ID	OD	Width
21087-3474	53	6.875	7.875	0.625	175	200	16	21091-3544	53	7.500	8.500	0.625	191	216	16
21087-3480	53	6.875	8.250	0.625	175	210	16	21091-3604	53	8.250	9.250	0.625	210	235	16
21087-3492	53	7.000	8.000	0.625	178	203	16	21091-3676	53	10.250	12.250	0.750	260	311	19
21087-3500	53	7.000	8.500	0.625	178	216	16	21091-3709	53-L	12.000	14.000	1.000	305	356	25
21087-3526	53	7.250	8.750	0.625	184	222	16	21091-3917	53	6.437	7.500	0.500	163	191	13
21087-3544	53	7.500	8.500	0.625	191	216	16	21091-3935	53	8.500	9.500	0.625	216	241	16
21087-3553	53	7.500	9.000	0.750	191	229	19	21091-4531	53-L	13.750	15.500	0.750	349	394	19
21087-3558	53	7.625	8.625	0.625	194	219	16	21093-2270	53	3.250	4.249	0.500	83	108	13
21087-3570	53	7.750	8.750	0.625	197	222	16	21093-4509	53	9.250	10.250	0.625	235	260	16
21087-3600	53	8.000	9.500	0.625	203	241	16	21095-2201	53	3.062	4.125	0.500	78	105	13
21087-3606	53	8.250	9.500	0.625	210	241	16	21095-2249	53	3.188	4.249	0.500	81	108	13
21087-3608	53	8.375	9.750	0.750	213	248	19	21095-2276	53	3.250	4.500	0.500	83	114	13
21087-3646	53	9.500	11.500	0.625	241	292	16	21095-2300	53	3.313	4.500	0.500	84	114	13
21087-3691	53	11.000	12.000	0.625	279	305	16	21095-2324	53	3.375	4.500	0.500	86	114	13
21087-3692	53	11.000	12.250	0.625	279	311	16	21095-2357	53	3.438	5.000	0.500	87	127	13
21087-3924	53	8.000	10.000	0.688	203	254	17	21095-2360	53	3.437	5.125	0.500	87	130	13
21087-3937	53	8.500	10.000	0.750	216	254	19	21095-2366	53	3.500	4.500	0.500	89	114	13
21087-3967	53	9.250	11.250	0.750	235	286	19	21095-2368	53	3.500	4.500	0.625	89	114	16
21087-3991	53	9.875	11.500	0.750	251	292	19	21095-2378	53	3.500	5.000	0.500	89	127	13
21087-4005	53	10.250	11.750	0.750	260	298	19	21095-2402	53	3.563	5.000	0.500	91	127	13
21087-4014	53	10.500	12.250	0.750	267	311	19	21095-2423	53	3.625	4.875	0.500	92	124	13
21087-4019	53	10.625	12.250	0.750	270	311	19	21095-2450	53	3.688	5.125	0.500	94	130	13
21087-4067	53	12.000	13.500	0.750	305	343	19	21095-2462	53	3.750	4.750	0.500	95	121	13
21087-4094	53-L	13.000	14.500	0.750	330	368	19	21095-2474	53	3.750	5.250	0.500	95	133	13
21087-4185	53-L	16.500	18.000	0.750	419	457	19	21095-2486	53	3.813	5.000	0.500	97	127	13
21087-4503	53	9.000	10.000	0.625	229	254	16	21095-2507	53	3.875	5.125	0.500	98	130	13
21087-4509	53	9.250	10.250	0.625	235	260	16	21095-2516	53	3.875	5.500	0.500	98	140	13
21087-4834	53	7.875	9.055	0.500	200	230	13	21095-2519	53	3.938	5.000	0.500	100	127	13
21087-7268	53	6.693	7.875	0.591	170	200	15	21095-2537	53	4.000	4.999	0.500	102	127	13
21087-7383	53	5.512	6.693	0.551	140	170	14	21095-2600	53	4.125	5.125	0.500	105	130	13
21087-7388	53	7.874	9.055	0.591	200	230	15	21095-2630	53	4.188	5.250	0.500	106	133	13
21087-7839	53	3.543	4.724	0.472	90	120	12	21095-2636	53	4.188	5.500	0.500	106	140	13
21088-2255	53	3.188	4.500	0.500	81	114	13	21095-2645	53	4.188	5.875	0.500	106	149	13
21088-2270	53	3.250	4.249	0.500	83	108	13	21095-2657	53	4.250	5.250	0.500	108	133	13
21088-2297	53	3.313	4.375	0.500	84	111	13	21095-2753	53	4.500	5.500	0.500	114	140	13
21088-2392	53	3.500	5.500	0.625	89	140	16	21095-2759	53	4.500	5.750	0.500	114	146	13
21088-2420	53	3.625	4.750	0.500	92	121	13	21095-2837	53	4.750	5.750	0.500	121	146	13
21088-2421	53	3.625	4.750	0.563	92	121	14	21095-2918	53	5.000	6.125	0.500	127	156	13
21088-2786	53	4.563	6.000	0.500	116	152	13	21095-2954	53	5.062	6.125	0.500	129	156	13
21088-3200	53	5.500	7.500	0.500	140	191	13	21095-2990	53	5.125	6.125	0.500	130	156	13
21088-3343	53	5.938	7.250	0.625	151	184	16	21095-3001	53	5.125	6.500	0.625	130	165	16
21091-2270	53	3.250	4.249	0.500	83	108	13	21095-3059	53	5.250	6.250	0.500	133	159	13
21091-2321	53	3.375	4.375	0.500	86	111	13	21095-3128	53	5.375	6.625	0.500	137	168	13
21091-2380	53	3.500	4.999	0.625	89	127	16	21095-3316	53	5.875	6.875	0.500	149	175	13
21091-2504	53	3.875	4.999	0.500	98	127	13	21095-3355	53	6.000	7.000	0.500	152	178	13
21091-2537	53	4.000	4.999	0.500	102	127	13	21095-3361	53	6.000	7.250	0.500	152	184	13
21091-2600	53	4.125	5.125	0.500	105	130	13	21095-3367	53	6.000	7.500	0.500	152	191	13
21091-2657	53	4.250	5.250	0.500	108	133	13	21095-3375	53	6.125	7.125	0.500	156	181	13
21091-2708	53	4.375	5.375	0.500	111	137	13	21095-3394	53	6.250	7.500	0.500	159	191	13
21091-2729	53	4.375	6.250	0.500	111	159	13	21095-3406	53	6.375	7.375	0.500	162	187	13
21091-2753	53	4.500	5.500	0.500	114	140	13	21095-3413	53	6.375	7.625	0.500	162	194	13
21091-2802	53	4.625	5.750	0.563	117	146	14	21095-3415	53	6.375	7.625	0.625	162	194	16
21091-2990	53	5.125	6.125	0.500	130	156	13	21095-3421	53	6.375	7.875	0.500	162	200	13
21091-3176	53	5.500	6.500	0.500	140	165	13	21095-3436	53	6.625	7.625	0.625	168	194	16
21091-3375	53	6.125	7.125	0.500	156	181	13	21095-3460	53	6.750	8.000	0.625	171	203	16
21091-3394	53	6.250	7.500	0.500	159	191	13	21095-3468	53	6.750	8.500	0.625	171	216	16

All dimensions are in inches. Preferred sizes are indicated with **bold** type face. Sizes listed are for standard nitrile elements, except Models 25 and 62 which have PTFE elements. Other material available on inquiry only.



## Oil Seals by Model Number

Product Code	Model	Inches			MM			Product Code	Model	Inches			MM		
		ID	OD	Width	ID	OD	Width			ID	OD	Width	ID	OD	Width
21095-3478	53	6.875	8.125	0.625	175	206	16	21096-2753	53	4.500	5.500	0.500	114	140	13
21095-3522	53	7.250	8.500	0.625	184	216	16	21096-2759	53	4.500	5.750	0.500	114	146	13
21095-3528	53	7.375	8.375	0.625	187	213	16	21096-2765	53	4.500	6.000	0.500	114	152	13
21095-3544	53	7.500	8.500	0.625	191	216	16	21096-2804	53	4.625	5.875	0.500	117	149	13
21095-3570	53	7.750	8.750	0.625	197	222	16	21096-2819	53	4.688	5.750	0.500	119	146	13
21095-3578	53	7.750	9.250	0.625	197	235	16	21096-2837	53	4.750	5.750	0.500	121	146	13
21095-3592	53	8.000	9.000	0.625	203	229	16	21096-2840	53	4.750	5.875	0.500	121	149	13
21095-3596	53	8.000	9.250	0.625	203	235	16	21096-2894	53	4.938	6.000	0.500	125	152	13
21095-3600	53	8.000	9.500	0.625	203	241	16	21096-2900	53	4.938	6.250	0.500	125	159	13
21095-3604	53	8.250	9.250	0.625	210	235	16	21096-2906	53	4.938	6.500	0.500	125	165	13
21095-3606	53	8.250	9.500	0.625	210	241	16	21096-2915	53	5.000	6.000	0.500	127	152	13
21095-3607	53	8.250	10.250	1.000	210	260	25	21096-2921	53	5.000	6.250	0.500	127	159	13
21095-3608	53	8.375	9.750	0.750	213	248	19	21096-2922	53	5.000	6.250	0.562	127	159	14
21095-3610	53	8.500	10.500	1.000	216	267	25	21096-2923	53	5.000	6.250	0.625	127	159	16
21095-3624	53	9.000	11.000	1.000	229	279	25	21096-2924	53	5.000	6.375	0.500	127	162	13
21095-3638	53	9.500	10.500	0.625	241	267	16	21096-2930	53	5.000	6.625	0.500	127	168	13
21095-3640	53	9.500	10.750	0.625	241	273	16	21096-2945	53	5.000	7.250	0.500	127	184	13
21095-3660	53	10.000	11.000	0.563	254	279	14	21096-3026	53	5.188	6.250	0.500	132	159	13
21095-3685	53	10.750	12.250	0.562	273	311	14	21096-3059	53	5.250	6.250	0.500	133	159	13
21095-3694	53	11.000	13.000	1.000	279	330	25	21096-3062	53	5.250	6.375	0.500	133	162	13
21095-3917	53	6.438	7.500	0.500	164	191	13	21096-3071	53	5.250	6.750	0.500	133	171	13
21095-3949	53	8.750	10.500	0.750	222	267	19	21096-3122	53	5.375	6.375	0.500	137	162	13
21095-4020	53	10.625	12.375	0.750	270	314	19	21096-3131	53	5.375	6.750	0.500	137	171	13
21095-4058	53	11.500	13.000	0.750	292	330	19	21096-3152	53	5.437	6.625	0.500	138	168	13
21095-4152	53-L	15.000	16.500	0.750	381	419	19	21096-3155	53	5.438	6.750	0.500	138	171	13
21095-4503	53	9.000	10.000	0.625	229	254	16	21096-3176	53	5.500	6.500	0.500	140	165	13
21095-4817	53	3.938	4.938	0.500	100	125	13	21096-3184	53	5.500	6.750	0.625	140	171	16
21095-7271	53	4.528	5.512	0.472	115	140	12	21096-3185	53	5.500	6.875	0.500	140	175	13
21095-7807	53	7.087	8.267	0.591	180	210	15	21096-3188	53	5.500	7.000	0.500	140	178	13
21095-7887	53	8.267	9.842	0.551	210	250	14	21096-3200	53	5.500	7.500	0.500	140	191	13
21095-7942	53	3.000	4.724	0.500	76	120	13	21096-3228	53	5.625	6.625	0.500	143	168	13
21096-2180	53	3.000	4.249	0.500	76	108	13	21096-3234	53	5.625	6.875	0.500	143	175	13
21096-2229	53	3.125	4.249	0.563	79	108	14	21096-3275	53	5.750	6.750	0.500	146	171	13
21096-2252	53	3.188	4.375	0.500	81	111	13	21096-3283	53	5.750	7.000	0.625	146	178	16
21096-2270	53	3.250	4.249	0.500	83	108	13	21096-3316	53	5.875	6.875	0.500	149	175	13
21096-2288	53	3.250	4.999	0.500	83	127	13	21096-3319	53	5.875	7.000	0.500	149	178	13
21096-2345	53	3.438	4.500	0.500	87	114	13	21096-3322	53	5.875	7.125	0.500	149	181	13
21096-2348	53	3.438	4.625	0.500	87	117	13	21096-3335	53	5.938	7.000	0.500	151	178	13
21096-2366	53	3.500	4.500	0.500	89	114	13	21096-3355	53	6.000	7.000	0.500	152	178	13
21096-2378	53	3.500	5.000	0.500	89	127	13	21096-3361	53	6.000	7.250	0.500	152	184	13
21096-2384	53	3.500	5.250	0.500	89	133	13	21096-3367	53	6.000	7.500	0.500	152	191	13
21096-2420	53	3.625	4.750	0.500	92	121	13	21096-3369	53	6.000	7.500	0.625	152	191	16
21096-2462	53	3.750	4.750	0.500	95	121	13	21096-3378	53	6.125	7.250	0.500	156	184	13
21096-2465	53	3.750	4.875	0.500	95	124	13	21096-3388	53	6.250	7.250	0.500	159	184	13
21096-2468	53	3.750	4.999	0.500	95	127	13	21096-3405	53	6.250	7.750	0.750	159	197	19
21096-2516	53	3.875	5.500	0.500	98	140	13	21096-3406	53	6.375	7.375	0.500	162	187	13
21096-2519	53	3.938	5.000	0.500	100	127	13	21096-3426	53	6.500	7.500	0.625	165	191	16
21096-2537	53	4.000	4.999	0.500	102	127	13	21096-3428	53	6.500	7.625	0.625	165	194	16
21096-2539	53	4.000	4.999	0.625	102	127	16	21096-3434	53	6.500	8.000	0.625	165	203	16
21096-2540	53	4.000	5.125	0.500	102	130	13	21096-3435	53	6.500	8.000	0.750	165	203	19
21096-2600	53	4.125	5.125	0.500	105	130	13	21096-3436	53	6.625	7.625	0.625	168	194	16
21096-2642	53	4.188	5.750	0.500	106	146	13	21096-3442	53	6.625	8.000	0.625	168	203	16
21096-2645	53	4.188	5.875	0.500	106	149	13	21096-3456	53	6.750	7.750	0.625	171	197	16
21096-2669	53	4.250	5.750	0.500	108	146	13	21096-3464	53	6.750	8.250	0.625	171	210	16
21096-2708	53	4.375	5.375	0.500	111	137	13	21096-3474	53	6.875	7.875	0.625	175	200	16
21096-2739	53	4.438	5.750	0.563	113	146	14	21096-3492	53	7.000	8.000	0.625	178	203	16

All dimensions are in inches. Preferred sizes are indicated with **bold** type face.

Sizes listed are for standard nitrile elements, except Models 25 and 62 which have PTFE elements. Other material available on inquiry only.

## Oil Seals by Model Number

Product Code	Model	Inches			MM			Product Code	Model	Inches			MM		
		ID	OD	Width	ID	OD	Width			ID	OD	Width	ID	OD	Width
21096-3496	53	7.000	8.250	0.625	178	210	16	21096-7396	53	4.331	5.512	0.472	110	140	12
21096-3500	53	7.000	8.500	0.625	178	216	16	21096-7399	53	3.346	4.921	0.472	85	125	12
21096-3508	53	7.125	8.250	0.625	181	210	16	21096-7807	53	7.087	8.267	0.591	180	210	15
21096-3510	53	7.125	8.375	0.625	181	213	16	21096-7836	53	4.724	6.299	0.472	120	160	12
21096-3514	53	7.125	8.625	0.625	181	219	16	21096-7842	53	3.938	5.118	0.472	100	130	12
21096-3518	53	7.250	8.250	0.625	184	210	16	21096-7887	53	8.267	9.842	0.551	210	250	14
21096-3536	53	7.375	8.875	0.625	187	225	16	21096-7893	53	11.811	13.386	0.629	300	340	16
21096-3544	53	7.500	8.500	0.625	191	216	16	21096-7979	53	3.938	5.118	0.500	100	130	13
21096-3548	53	7.500	8.750	0.625	191	222	16	21096-8049	53	7.480	8.661	0.591	190	220	15
21096-3558	53	7.625	8.625	0.625	194	219	16	21098-2372	53	3.500	4.750	0.500	89	121	13
21096-3570	53	7.750	8.750	0.625	197	222	16	21098-2546	53	4.000	5.375	0.500	102	137	13
21096-3578	53	7.750	9.250	0.625	197	235	16	21098-4560	53	6.500	7.500	0.500	165	191	13
21096-3584	53	7.875	9.125	0.625	200	232	16	21100-3394	53	6.250	7.500	0.500	159	191	13
21096-3588	53	7.875	9.375	0.625	200	238	16	21373-2186	53	3.000	4.500	0.500	76	114	13
21096-3592	53	8.000	9.000	0.625	203	229	16	21373-2561	53	4.000	6.000	0.500	102	152	13
21096-3596	53	8.000	9.250	0.625	203	235	16	21409-2177	53	3.000	4.125	0.500	76	105	13
21096-3600	53	8.000	9.500	0.625	203	241	16	21409-2225	53	3.125	4.125	0.500	79	105	13
21096-3604	53	8.250	9.250	0.625	210	235	16	21409-2249	53	3.188	4.249	0.500	81	108	13
21096-3606	53	8.250	9.500	0.625	210	241	16	21409-2270	53	3.250	4.249	0.500	83	108	13
21096-3624	53	9.000	11.000	1.000	229	279	25	21409-2366	53	3.500	4.500	0.500	89	114	13
21096-3629	53	9.250	10.375	0.750	235	264	19	21409-2417	53	3.625	4.625	0.500	92	117	13
21096-3632	53	9.250	10.750	0.750	235	273	19	21409-2465	53	3.750	4.875	0.500	95	124	13
21096-3634	53	9.375	11.375	1.000	238	289	25	21409-2537	53	4.000	4.999	0.500	102	127	13
21096-3642	53	9.500	11.000	0.625	241	279	16	21409-2543	53	4.000	5.250	0.500	102	133	13
21096-3648	53	9.500	11.500	1.000	241	292	25	21409-2630	53	4.188	5.250	0.500	106	133	13
21096-3649	53	9.625	11.625	1.000	244	295	25	21409-2753	53	4.500	5.500	0.500	114	140	13
21096-3673	53	10.000	12.000	1.000	254	305	25	21409-2837	53	4.750	5.750	0.500	121	146	13
21096-3691	53	11.000	12.000	0.625	279	305	16	21409-2900	53	4.938	6.250	0.500	125	159	13
21096-3692	53	11.000	12.250	0.625	279	311	16	21409-3122	53	5.375	6.375	0.500	137	162	13
21096-3693	53	11.000	12.500	0.625	279	318	16	21409-3421	53	6.375	7.875	0.500	162	200	13
21096-3722	53-L	13.750	15.750	1.000	349	400	25	21409-3426	53	6.500	7.500	0.625	165	191	16
21096-3924	53	8.000	10.000	0.688	203	254	17	21409-3492	53	7.000	8.000	0.625	178	203	16
21096-3935	53	8.500	9.500	0.625	216	241	16	21409-7268	53	6.693	7.874	0.591	170	200	15
21096-3937	53	8.500	10.000	0.750	216	254	19	21409-7376	53	4.724	5.906	0.472	120	150	12
21096-3941	53	8.625	10.250	0.750	219	260	19	21409-7383	53	5.512	6.693	0.551	140	170	14
21096-3991	53	9.875	11.500	0.750	251	292	19	21477-3428	53	6.500	7.625	0.625	165	194	16
21096-3992	53	10.000	11.500	0.688	254	292	17	21477-3456	53	6.750	7.750	0.625	171	197	16
21096-4016	53	10.500	12.500	0.750	267	318	19	21477-3460	53	6.750	8.000	0.625	171	203	16
21096-4068	53	12.000	13.625	0.750	305	346	19	21477-3648	53	9.500	11.500	1.000	241	292	25
21096-4071	53-L	12.000	14.000	0.750	305	356	19	21477-3682	53	10.750	11.750	0.563	273	298	14
21096-4502	53	8.500	10.000	0.625	216	254	16	21477-3924	53	8.000	10.000	0.688	203	254	17
21096-4503	53	9.000	10.000	0.625	229	254	16	21477-3990	53	9.875	11.375	0.750	251	289	19
21096-4507	53	9.000	10.500	0.625	229	267	16	21477-4016	53	10.500	12.500	0.750	267	318	19
21096-4513	53	9.750	10.750	0.625	248	273	16	21477-4067	53	12.000	13.500	0.750	305	343	19
21096-4524	53	10.750	12.500	0.625	273	318	16	21477-4198	53-L	17.500	19.500	0.688	445	495	17
21096-4643	53	3.937	5.118	0.591	100	130	15	21477-4501	53	8.437	10.000	0.625	214	254	16
21096-4644	53	4.134	5.512	0.591	105	140	15	21477-4503	53	9.000	10.000	0.625	229	254	16
21096-4649	53	4.921	6.299	0.591	125	160	15	21477-4505	53	9.000	10.250	0.625	229	260	16
21096-5357	53	8.661	9.842	0.591	220	250	15	21530-4501	53	8.438	10.000	0.625	214	254	16
21096-6386	53	8.750	10.000	0.625	222	254	16	21557-2324	53	3.375	4.500	0.500	86	114	13
21096-7267	53	5.512	6.693	0.591	140	170	15	21557-2345	53	3.438	4.500	0.500	87	114	13
21096-7268	53	6.693	7.875	0.591	170	200	15	21557-2462	53	3.750	4.750	0.500	95	121	13
21096-7276	53	6.299	7.480	0.591	160	190	15	21557-2753	53	4.500	5.500	0.500	114	140	13
21096-7277	53	4.724	5.906	0.591	120	150	15	21557-3059	53	5.250	6.250	0.500	133	159	13
21096-7376	53	4.724	5.905	0.472	120	150	12	21557-3179	53	5.500	6.625	0.500	140	168	13
21096-7388	53	7.874	9.055	0.591	200	230	15	21557-3474	53	6.875	7.875	0.625	175	200	16

All dimensions are in inches. Preferred sizes are indicated with **bold** type face. Sizes listed are for standard nitrile elements, except Models 25 and 62 which have PTFE elements. Other material available on inquiry only.

## Oil Seals by Model Number

Product Code	Model	Inches			MM			Product Code	Model	Inches			MM		
		ID	OD	Width	ID	OD	Width			ID	OD	Width	ID	OD	Width
21557-3478	53	6.875	8.125	0.625	175	206	16	21699-2356	53	3.437	4.875	0.625	87	124	16
21597-2177	53	3.000	4.125	0.500	76	105	13	21699-2357	53	3.438	4.999	0.500	87	127	13
21597-2186	53	3.000	4.500	0.500	76	114	13	21699-2366	53	3.500	4.500	0.500	89	114	13
21597-2249	53	3.188	4.250	0.500	81	108	13	21699-2372	53	3.500	4.750	0.500	89	121	13
21597-2366	53	3.500	4.500	0.500	89	114	13	21699-2384	53	3.500	5.250	0.500	89	133	13
21597-2372	53	3.500	4.750	0.500	89	121	13	21699-2387	53	3.500	5.375	0.500	89	137	13
21597-2426	53	3.625	5.000	0.500	92	127	13	21699-2390	53	3.500	5.500	0.500	89	140	13
21597-2462	53	3.750	4.750	0.500	95	121	13	21699-2396	53	3.562	4.750	0.500	90	121	13
21597-2510	53	3.875	5.250	0.500	98	133	13	21699-2417	53	3.625	4.625	0.500	92	117	13
21597-2537	53	4.000	4.999	0.500	102	127	13	21699-2420	53	3.625	4.750	0.500	92	121	13
21597-2543	53	4.000	5.250	0.500	102	133	13	21699-2423	53	3.625	4.875	0.500	92	124	13
21597-2717	53	4.375	5.750	0.500	111	146	13	21699-2432	53	3.625	5.250	0.500	92	133	13
21597-2753	53	4.500	5.500	0.500	114	140	13	21699-2441	53	3.688	4.750	0.500	94	121	13
21597-2917	53	5.000	6.000	0.625	127	152	16	21699-2447	53	3.688	5.000	0.500	94	127	13
21597-2954	53	5.063	6.125	0.500	129	156	13	21699-2450	53	3.688	5.125	0.500	94	130	13
21597-3122	53	5.375	6.375	0.500	137	162	13	21699-2462	53	3.750	4.750	0.500	95	121	13
21597-3276	53	5.750	6.750	0.563	146	171	14	21699-2465	53	3.750	4.875	0.500	95	124	13
21597-3319	53	5.875	7.000	0.500	149	178	13	21699-2468	53	3.750	4.999	0.500	95	127	13
21597-3335	53	5.938	7.000	0.500	151	178	13	21699-2480	53	3.750	5.500	0.500	95	140	13
21597-3343	53	5.938	7.250	0.625	151	184	16	21699-2486	53	3.813	5.000	0.500	97	127	13
21597-3355	53	6.000	7.000	0.500	152	178	13	21699-2501	53	3.875	4.875	0.500	98	124	13
21597-3446	53	6.625	8.250	0.625	168	210	16	21699-2507	53	3.875	5.125	0.500	98	130	13
21597-3544	53	7.500	8.500	0.625	191	216	16	21699-2510	53	3.875	5.250	0.500	98	133	13
21597-3606	53	8.250	9.500	0.625	210	241	16	21699-2513	53	3.875	5.375	0.500	98	137	13
21597-4185	53-L	16.500	18.000	0.750	419	457	19	21699-2516	53	3.875	5.500	0.500	98	140	13
21597-6602	53	6.125	7.625	0.625	156	194	16	21699-2519	53	3.938	5.000	0.500	100	127	13
21683-2177	53	3.000	4.125	0.500	76	105	13	21699-2537	53	4.000	4.999	0.500	102	127	13
21683-2270	53	3.250	4.249	0.500	83	108	13	21699-2540	53	4.000	5.125	0.500	102	130	13
21683-2753	53	4.500	5.500	0.500	114	140	13	21699-2546	53	4.000	5.375	0.500	102	137	13
21683-3275	53	5.750	6.750	0.500	146	171	13	21699-2549	53	4.000	5.500	0.500	102	140	13
21683-3518	53	7.250	8.250	0.625	184	210	16	21699-2555	53	4.000	5.750	0.500	102	146	13
21684-3574	53	7.750	9.000	0.625	197	229	16	21699-2556	53	4.000	5.750	0.563	102	146	14
21684-3606	53	8.250	9.500	0.625	210	241	16	21699-2567	53	4.000	6.250	0.500	102	159	13
21699-2177	53	3.000	4.125	0.500	76	105	13	21699-2573	53	4.063	5.250	0.500	103	133	13
21699-2182	53	3.000	4.249	0.625	76	108	16	21699-2600	53	4.125	5.125	0.500	105	130	13
21699-2186	53	3.000	4.500	0.500	76	114	13	21699-2603	53	4.125	5.250	0.500	105	133	13
21699-2198	53	3.000	5.000	0.500	76	127	13	21699-2606	53	4.125	5.375	0.500	105	137	13
21699-2201	53	3.062	4.125	0.500	78	105	13	21699-2609	53	4.125	5.500	0.500	105	140	13
21699-2225	53	3.125	4.125	0.500	79	105	13	21699-2630	53	4.188	5.250	0.500	106	133	13
21699-2228	53	3.125	4.249	0.500	79	108	13	21699-2636	53	4.188	5.500	0.500	106	140	13
21699-2231	53	3.125	4.375	0.500	79	111	13	21699-2645	53	4.188	5.875	0.500	106	149	13
21699-2234	53	3.125	4.500	0.500	79	114	13	21699-2648	53	4.188	6.000	0.500	106	152	13
21699-2240	53	3.125	4.750	0.500	79	121	13	21699-2657	53	4.250	5.250	0.500	108	133	13
21699-2249	53	3.188	4.250	0.500	81	108	13	21699-2660	53	4.250	5.375	0.500	108	137	13
21699-2252	53	3.188	4.375	0.500	81	111	13	21699-2663	53	4.000	5.500	0.500	102	140	13
21699-2255	53	3.188	4.500	0.500	81	114	13	21699-2665	53	4.250	5.500	0.625	108	140	16
21699-2261	53	3.188	4.750	0.500	81	121	13	21699-2669	53	4.250	5.750	0.500	108	146	13
21699-2270	53	3.250	4.249	0.500	83	108	13	21699-2675	53	4.250	6.000	0.500	108	152	13
21699-2272	53	3.250	4.249	0.625	83	108	16	21699-2684	53	4.313	5.375	0.500	110	137	13
21699-2273	53	3.250	4.375	0.500	83	111	13	21699-2687	53	4.313	5.500	0.500	110	140	13
21699-2276	53	3.250	4.500	0.500	83	114	13	21699-2690	53	4.313	5.625	0.500	110	143	13
21699-2279	53	3.250	4.625	0.500	83	117	13	21699-2708	53	4.375	5.375	0.500	111	137	13
21699-2321	53	3.375	4.375	0.500	86	111	13	21699-2711	53	4.375	5.500	0.500	111	140	13
21699-2336	53	3.375	5.000	0.500	86	127	13	21699-2732	53	4.438	5.500	0.500	113	140	13
21699-2345	53	3.437	4.500	0.500	87	114	13	21699-2738	53	4.437	5.750	0.500	113	146	13
21699-2351	53	3.437	4.750	0.500	87	121	13	21699-2753	53	4.500	5.500	0.500	114	140	13

All dimensions are in inches. Preferred sizes are indicated with **bold** type face.

Sizes listed are for standard nitrile elements, except Models 25 and 62 which have PTFE elements. Other material available on inquiry only.

## Oil Seals by Model Number

Product Code	Model	Inches			MM			Product Code	Model	Inches			MM		
		ID	OD	Width	ID	OD	Width			ID	OD	Width	ID	OD	Width
21699-2755	53	4.500	5.500	0.625	114	140	16	21699-3240	53	5.625	7.125	0.500	143	181	13
21699-2756	53	4.500	5.625	0.500	114	143	13	21699-3275	53	5.750	6.750	0.500	146	171	13
21699-2760	53	4.500	5.750	0.563	114	146	14	21699-3276	53	5.750	6.750	0.563	146	171	14
21699-2765	53	4.500	6.000	0.500	114	152	13	21699-3281	53	5.750	7.000	0.500	146	178	13
21699-2767	53	4.500	6.000	0.625	114	152	16	21699-3289	53	5.750	7.250	0.625	146	184	16
21699-2771	53	4.500	6.250	0.500	114	159	13	21699-3316	53	5.875	6.875	0.500	149	175	13
21699-2780	53	4.562	5.750	0.500	116	146	13	21699-3319	53	5.875	7.000	0.500	149	178	13
21699-2798	53	4.625	5.625	0.500	117	143	13	21699-3322	53	5.875	7.125	0.500	149	181	13
21699-2802	53	4.625	5.750	0.563	117	146	14	21699-3331	53	5.875	7.500	0.500	149	191	13
21699-2807	53	4.625	6.000	0.500	117	152	13	21699-3343	53	5.938	7.250	0.625	151	184	16
21699-2813	53	4.625	6.250	0.500	117	159	13	21699-3355	53	6.000	7.000	0.500	152	178	13
21699-2819	53	4.688	5.750	0.500	119	146	13	21699-3357	53	6.000	7.000	0.625	152	178	16
21699-2822	53	4.688	5.875	0.500	119	149	13	21699-3358	53	6.000	7.125	0.500	152	181	13
21699-2837	53	4.750	5.750	0.500	121	146	13	21699-3359	53	6.000	7.125	0.563	152	181	14
21699-2840	53	4.750	5.875	0.500	121	149	13	21699-3360	53	6.000	7.125	0.625	152	181	16
21699-2849	53	4.750	6.250	0.500	121	159	13	21699-3363	53	6.000	7.250	0.625	152	184	16
21699-2870	53	4.875	5.875	0.500	124	149	13	21699-3367	53	6.000	7.500	0.500	152	191	13
21699-2873	53	4.875	6.000	0.500	124	152	13	21699-3375	53	6.125	7.125	0.500	156	181	13
21699-2879	53	4.875	6.250	0.500	124	159	13	21699-3378	53	6.125	7.250	0.500	156	184	13
21699-2888	53	4.875	6.625	0.500	124	168	13	21699-3381	53	6.125	7.375	0.500	156	187	13
21699-2894	53	4.938	6.000	0.500	125	152	13	21699-3384	53	6.125	7.500	0.500	156	191	13
21699-2900	53	4.938	6.250	0.500	125	159	13	21699-3388	53	6.250	7.250	0.500	159	184	13
21699-2915	53	5.000	6.000	0.500	127	152	13	21699-3394	53	6.250	7.500	0.500	159	191	13
21699-2918	53	5.000	6.125	0.500	127	156	13	21699-3396	53	6.250	7.500	0.625	159	191	16
21699-2921	53	5.000	6.250	0.500	127	159	13	21699-3402	53	6.250	7.750	0.500	159	197	13
21699-2922	53	5.000	6.250	0.563	127	159	14	21699-3406	53	6.375	7.375	0.500	162	187	13
21699-2924	53	5.000	6.375	0.500	127	162	13	21699-3409	53	6.375	7.500	0.500	162	191	13
21699-2927	53	5.000	6.500	0.500	127	165	13	21699-3415	53	6.375	7.625	0.625	162	194	16
21699-2954	53	5.062	6.125	0.500	129	156	13	21699-3421	53	6.375	7.875	0.500	162	200	13
21699-2990	53	5.125	6.125	0.500	130	156	13	21699-3423	53	6.375	7.875	0.625	162	200	16
21699-3001	53	5.125	6.500	0.625	130	165	16	21699-3425	53	6.438	7.750	0.750	164	197	19
21699-3011	53	5.125	7.000	0.500	130	178	13	21699-3426	53	6.500	7.500	0.625	165	191	16
21699-3026	53	5.188	6.250	0.500	132	159	13	21699-3428	53	6.500	7.625	0.625	165	194	16
21699-3035	53	5.188	6.625	0.500	132	168	13	21699-3430	53	6.500	7.750	0.625	165	197	16
21699-3059	53	5.250	6.250	0.500	133	159	13	21699-3436	53	6.625	7.625	0.625	168	194	16
21699-3062	53	5.250	6.375	0.500	133	162	13	21699-3438	53	6.625	7.750	0.625	168	197	16
21699-3065	53	5.250	6.500	0.500	133	165	13	21699-3442	53	6.625	8.000	0.625	168	203	16
21699-3071	53	5.250	6.750	0.500	133	171	13	21699-3444	53	6.625	8.125	0.625	168	206	16
21699-3092	53	5.313	6.375	0.500	135	162	13	21699-3450	53	6.625	8.500	0.625	168	216	16
21699-3095	53	5.313	6.500	0.500	135	165	13	21699-3456	53	6.750	7.750	0.625	171	197	16
21699-3122	53	5.375	6.375	0.500	137	162	13	21699-3460	53	6.750	8.000	0.625	171	203	16
21699-3125	53	5.375	6.500	0.500	137	165	13	21699-3464	53	6.750	8.250	0.625	171	210	16
21699-3139	53	5.375	7.000	0.625	137	178	16	21699-3465	53	6.750	8.250	0.750	171	210	19
21699-3152	53	5.437	6.625	0.500	138	168	13	21699-3468	53	6.750	8.500	0.625	171	216	16
21699-3155	53	5.437	6.750	0.500	138	171	13	21699-3472	53	6.750	8.750	0.625	171	222	16
21699-3161	53	5.438	7.000	0.500	138	178	13	21699-3474	53	6.875	7.875	0.625	175	200	16
21699-3176	53	5.500	6.500	0.500	140	165	13	21699-3476	53	6.875	8.000	0.625	175	203	16
21699-3179	53	5.500	6.625	0.500	140	168	13	21699-3482	53	6.875	8.375	0.625	175	213	16
21699-3182	53	5.500	6.750	0.500	140	171	13	21699-3492	53	7.000	8.000	0.625	178	203	16
21699-3184	53	5.500	6.750	0.625	140	171	16	21699-3494	53	7.000	8.125	0.625	178	206	16
21699-3188	53	5.500	7.000	0.500	140	178	13	21699-3496	53	7.000	8.250	0.625	178	210	16
21699-3200	53	5.500	7.500	0.500	140	191	13	21699-3498	53	7.000	8.375	0.625	178	213	16
21699-3228	53	5.625	6.625	0.500	143	168	13	21699-3500	53	7.000	8.500	0.625	178	216	16
21699-3231	53	5.625	6.750	0.500	143	171	13	21699-3504	53	7.000	8.750	0.625	178	222	16
21699-3234	53	5.625	6.875	0.500	143	175	13	21699-3506	53	7.125	8.125	0.625	181	206	16
21699-3237	53	5.625	7.000	0.500	143	178	13	21699-3508	53	7.125	8.250	0.625	181	210	16

All dimensions are in inches. Preferred sizes are indicated with **bold** type face. Sizes listed are for standard nitrile elements, except Models 25 and 62 which have PTFE elements. Other material available on inquiry only.

## Oil Seals by Model Number

Product Code	Model	Inches			MM			Product Code	Model	Inches			MM		
		ID	OD	Width	ID	OD	Width			ID	OD	Width	ID	OD	Width
21699-3510	53	7.125	8.375	0.625	181	213	16	21699-4502	53	8.500	10.000	0.625	216	254	16
21699-3518	53	7.250	8.250	0.625	184	210	16	21699-4503	53	9.000	10.000	0.625	229	254	16
21699-3522	53	7.250	8.500	0.625	184	216	16	21699-4507	53	9.000	10.500	0.625	229	267	16
21699-3526	53	7.250	8.750	0.625	184	222	16	21699-4509	53	9.250	10.250	0.625	235	260	16
21699-3528	53	7.375	8.375	0.625	187	213	16	21699-4515	53	9.750	11.000	0.625	248	279	16
21699-3530	53	7.375	8.500	0.625	187	216	16	21699-4817	53	3.938	4.937	0.500	100	125	13
21699-3536	53	7.375	8.875	0.625	187	225	16	21699-5906	53	10.000	12.000	0.688	254	305	17
21699-3544	53	7.500	8.500	0.625	191	216	16	21699-7267	53	5.512	6.693	0.591	140	170	15
21699-3546	53	7.500	8.625	0.625	191	219	16	21699-7271	53	4.528	5.512	0.472	115	140	12
21699-3552	53	7.500	9.000	0.625	191	229	16	21699-7276	53	6.299	7.480	0.591	160	190	15
21699-3554	53	7.500	9.125	0.625	191	232	16	21699-7383	53	5.512	6.693	0.551	140	170	14
21699-3556	53	7.500	9.250	0.625	191	235	16	21699-7394	53	3.346	4.724	0.472	85	120	12
21699-3558	53	7.625	8.625	0.625	194	219	16	21699-7396	53	4.331	5.512	0.472	110	140	12
21699-3566	53	7.625	9.125	0.625	194	232	16	21699-7979	53	3.938	5.118	0.500	100	130	13
21699-3570	53	7.750	8.750	0.625	197	222	16	21699-8049	53	7.480	8.661	0.591	190	220	15
21699-3574	53	7.750	9.000	0.625	197	229	16	21699-8429	53	3.543	4.724	0.500	90	120	13
21699-3582	53	7.875	9.000	0.625	200	229	16	21699-9724	53	3.000	4.250	0.625	76	108	16
21699-3586	53	7.875	9.250	0.625	200	235	16	21806-3059	53	5.250	6.250	0.500	133	159	13
21699-3588	53	7.875	9.375	0.625	200	238	16	21806-3228	53	5.625	6.625	0.500	143	168	13
21699-3592	53	8.000	9.000	0.625	203	229	16	21806-4515	53	9.750	11.000	0.625	248	279	16
21699-3593	53	8.000	9.000	0.750	203	229	19	21947-2177	53	3.000	4.125	0.500	76	105	13
21699-3596	53	8.000	9.250	0.625	203	235	16	21947-2270	53	3.250	4.249	0.500	83	108	13
21699-3600	53	8.000	9.500	0.625	203	241	16	21947-2324	53	3.375	4.500	0.500	86	114	13
21699-3604	53	8.250	9.250	0.625	210	235	16	21947-2366	53	3.500	4.500	0.500	89	114	13
21699-3606	53	8.250	9.500	0.625	210	241	16	21947-2369	53	3.500	4.625	0.500	89	117	13
21699-3607	53	8.250	10.250	1.000	210	260	25	21947-2444	53	3.688	4.875	0.500	94	124	13
21699-3619	53	9.000	10.500	0.750	229	267	19	21947-2462	53	3.750	4.750	0.500	95	121	13
21699-3623	53	9.000	11.000	0.750	229	279	19	21947-2474	53	3.750	5.250	0.500	95	133	13
21699-3638	53	9.500	10.500	0.625	241	267	16	21947-2519	53	3.938	4.999	0.500	100	127	13
21699-3640	53	9.500	10.750	0.625	241	273	16	21947-2537	53	4.000	4.999	0.500	102	127	13
21699-3643	53	9.500	11.125	0.625	241	283	16	21947-2606	53	4.125	5.375	0.500	105	137	13
21699-3649	53	9.625	11.625	1.000	244	295	25	21947-2663	53	4.250	5.500	0.500	108	140	13
21699-3660	53	10.000	11.000	0.563	254	279	14	21947-2738	53	4.438	5.750	0.500	113	146	13
21699-3668	53	10.000	11.000	0.750	254	279	19	21947-2753	53	4.500	5.500	0.500	114	140	13
21699-3677	53	10.250	12.250	1.000	260	311	25	21947-2894	53	4.938	6.000	0.500	125	152	13
21699-3682	53	10.750	11.750	0.563	273	298	14	21947-2922	53	5.000	6.250	0.563	127	159	14
21699-3694	53	11.000	13.000	1.000	279	330	25	21947-2990	53	5.125	6.125	0.500	130	156	13
21699-3703	53	11.250	13.250	1.000	286	337	25	21947-3059	53	5.250	6.250	0.500	133	159	13
21699-3706	53	11.750	13.750	1.000	298	349	25	21947-3122	53	5.375	6.375	0.500	137	162	13
21699-3717	53-L	12.688	14.750	1.000	322	375	25	21947-3184	53	5.500	6.750	0.625	140	171	16
21699-3718	53-L	12.875	14.750	1.000	327	375	25	21947-3275	53	5.750	6.750	0.500	146	171	13
21699-3917	53	6.437	7.500	0.500	163	191	13	21947-3355	53	6.000	7.000	0.500	152	178	13
21699-3918	53	6.688	7.750	0.625	170	197	16	21947-3394	53	6.250	7.500	0.500	159	191	13
21699-3935	53	8.500	9.500	0.625	216	241	16	21947-3421	53	6.375	7.875	0.500	162	200	13
21699-3943	53	8.625	10.500	0.750	219	267	19	21947-3428	53	6.500	7.625	0.625	165	194	16
21699-3949	53	8.750	10.500	0.750	222	267	19	21947-3480	53	6.875	8.250	0.625	175	210	16
21699-3959	53	9.125	10.750	0.750	232	273	19	21947-3492	53	7.000	8.000	0.625	178	203	16
21699-3967	53	9.250	11.250	0.750	235	286	19	21947-3518	53	7.250	8.250	0.625	184	210	16
21699-3992	53	10.000	11.500	0.688	254	292	17	21947-3592	53	8.000	9.000	0.625	203	229	16
21699-4005	53	10.250	11.750	0.750	260	298	19	21947-3967	53	9.250	11.250	0.750	235	286	19
21699-4012	53	10.500	12.000	0.750	267	305	19	21947-4509	53	9.250	10.250	0.625	235	260	16
21699-4046	53	11.250	12.750	0.750	286	324	19	21947-7268	53	6.693	7.875	0.591	170	200	15
21699-4109	53-L	13.250	15.375	1.000	337	391	25	21947-7276	53	6.299	7.480	0.590	160	190	15
21699-4477	53	6.938	8.125	0.625	176	206	16	21947-7383	53	5.512	6.693	0.551	140	170	14
21699-4478	53	6.938	8.375	0.625	176	213	16	21947-7388	53	7.875	9.055	0.591	200	230	15
21699-4490	53	6.062	7.500	0.500	154	191	13	21947-7950	53	3.187	4.331	0.500	81	110	13

All dimensions are in inches. Preferred sizes are indicated with **bold** type face.

Sizes listed are for standard nitrile elements, except Models 25 and 62 which have PTFE elements. Other material available on inquiry only.

## Oil Seals by Model Number

Product Code	Model	Inches			MM			Product Code	Model	Inches			MM		
		ID	OD	Width	ID	OD	Width			ID	OD	Width	ID	OD	Width
21947-8768	53	4.134	5.118	0.472	105	130	12	26060-3911	57	7.480	8.858	0.630	190	225	16
21140-6003	54	2.375	5.125	0.625	60	130	16	26063-2455	57	2.559	4.724	0.315	65	120	8
21140-6005	54	2.750	6.000	0.625	70	152	16	26063-2522	57	3.938	5.125	0.500	100	130	13
21140-6008	54	3.563	7.250	0.563	91	184	14	26063-2921	57	5.000	6.250	0.500	127	159	13
21140-6009	54	3.750	8.000	0.625	95	203	16	26063-2933	57	5.000	6.750	0.500	127	171	13
21140-6010	54	4.000	8.000	0.625	102	203	16	26063-3355	57	6.000	7.000	0.500	152	178	13
21140-6014	54	4.375	9.125	0.625	111	232	16	26063-3920	57	7.087	8.268	0.630	180	210	16
21140-6018	54	5.000	9.750	0.625	127	248	16	26063-7267	57	5.512	6.693	0.591	140	170	15
21140-6020	54	5.250	10.750	0.688	133	273	17	26063-7268	57	6.693	7.875	0.591	170	200	15
21140-6021	54	5.625	11.375	1.000	143	289	25	26063-7276	57	6.299	7.480	0.591	160	190	15
21140-6022	54-L	6.380	14.000	0.875	162	356	22	21003-0584	58	6.496	7.480	0.512	165	190	13
21140-6023	54	6.625	12.500	0.625	168	318	16	21003-0595	58	1.438	2.250	0.375	37	57	10
21140-6024	54	7.000	13.500	0.750	178	343	19	21003-0646	58	1.500	2.375	0.375	38	60	10
21140-7351	54	4.250	8.250	0.625	108	210	16	21003-0655	58	1.500	2.500	0.375	38	64	10
21140-9750	54-L	8.000	14.750	0.625	203	375	16	21003-1189	58	2.000	2.750	0.375	51	70	10
21140-9986	54	4.750	9.250	0.625	121	235	16	21003-1490	58	2.362	2.953	0.315	60	75	8
26056-4214	57	1.949	3.031	0.709	50	77	18	21003-1797	58	1.772	2.441	0.394	45	62	10
26056-4656	57	5.118	6.299	0.472	130	160	12	21003-1921	58	2.953	3.937	0.512	75	100	13
26056-7267	57	5.512	6.693	0.591	140	170	15	21003-1979	58	3.937	5.118	0.630	100	130	16
26057-0783	57	6.693	7.875	0.512	170	200	13	21003-2180	58	3.000	4.249	0.500	76	108	13
26057-0958	57	5.709	6.890	0.591	145	175	15	21003-2225	58	3.125	4.125	0.500	79	105	13
26057-2522	57	3.938	5.125	0.500	100	130	13	21003-2255	58	3.187	4.500	0.500	81	114	13
26057-2779	57	4.528	5.512	0.472	115	140	12	21003-2262	58	4.409	5.709	0.551	112	145	14
26057-2921	57	5.000	6.250	0.500	127	159	13	21003-2295	58	1.375	2.562	0.500	35	65	13
26057-2933	57	5.000	6.750	0.500	127	171	13	21003-2384	58	3.500	5.250	0.500	89	133	13
26057-3065	57	5.250	6.500	0.500	133	165	13	21003-2417	58	3.625	4.625	0.500	92	117	13
26057-3355	57	6.000	7.000	0.500	152	178	13	21003-2462	58	3.750	4.750	0.500	95	121	13
26057-3910	57	9.449	10.828	0.630	240	275	16	21003-2488	58	2.362	4.331	0.512	60	110	13
26057-3911	57	7.480	8.859	0.630	190	225	16	21003-2490	58	8.540	9.750	0.625	217	248	16
26057-5335	57	5.906	7.087	0.551	150	180	14	21003-2692	58	7.250	8.750	0.875	184	222	22
26057-7267	57	5.512	6.693	0.591	140	170	15	21003-2710	58	4.999	5.905	0.512	127	150	13
26057-7268	57	6.693	7.875	0.591	170	200	15	21003-2782	58	4.563	5.750	0.625	116	146	16
26057-7276	57	6.299	7.480	0.591	160	190	15	21003-2887	58	4.922	5.906	0.473	125	150	12
26057-7816	57	6.299	7.480	0.512	160	190	13	21003-2902	58	1.969	2.835	0.394	50	72	10
26058-0958	57	5.709	6.890	0.591	145	175	15	21003-2989	58	5.118	6.299	0.551	130	160	14
26058-2522	57	3.938	5.125	0.500	100	130	13	21003-3059	58	5.250	6.250	0.500	133	159	13
26058-2716	57	8.465	9.646	0.630	215	245	16	21003-3085	58	3.150	3.937	0.472	80	100	12
26058-2779	57	4.528	5.512	0.472	115	140	12	21003-3176	58	5.500	6.500	0.500	140	165	13
26058-2921	57	5.000	6.250	0.500	127	159	13	21003-3327	58	5.906	7.087	0.591	150	180	15
26058-2933	57	5.000	6.750	0.500	127	171	13	21003-3331	58	5.875	7.500	0.500	149	191	13
26058-3355	57	6.000	7.000	0.500	152	178	13	21003-3346	58	3.813	4.999	0.625	97	127	16
26058-3911	57	7.480	8.859	0.630	190	225	16	21003-3464	58	6.750	8.250	0.625	171	210	16
26058-3920	57	7.087	8.268	0.630	180	210	16	21003-3474	58	6.875	7.875	0.625	175	200	16
26058-4656	57	5.118	6.299	0.472	130	160	12	21003-3499	58	7.000	8.375	0.750	178	213	19
26058-5334	57	9.055	10.236	0.591	230	260	15	21003-3515	58	7.125	8.625	0.750	181	219	19
26058-5335	57	5.906	7.087	0.551	150	180	14	21003-3528	58	7.375	8.375	0.625	187	213	16
26058-6061	57	3.740	4.724	0.512	95	120	13	21003-3866	58	1.500	2.250	0.468	38	57	12
26058-7267	57	5.512	6.693	0.591	140	170	15	21003-3967	58	9.250	11.250	0.750	235	286	19
26058-7268	57	6.693	7.874	0.591	170	200	15	21003-4263	58	3.937	4.724	0.433	100	120	11
26058-7276	57	6.299	7.480	0.591	160	190	15	21003-4264	58	4.331	5.512	0.551	110	140	14
26058-7816	57	6.299	7.480	0.512	160	190	13	21003-4392	58	2.756	3.740	0.472	70	95	12
26058-8049	57	7.480	8.661	0.591	190	220	15	21003-4410	58	3.307	4.331	0.500	84	110	13
26058-8655	57	10.630	12.205	0.630	270	310	16	21003-4411	58	2.375	3.375	0.500	60	86	13
26058-8768	57	4.133	5.118	0.472	105	130	12	21003-7388	58	7.875	9.055	0.591	200	230	15
26059-2779	57	4.528	5.512	0.472	115	140	12	21003-7884	58	1.575	2.441	0.394	40	62	10
26060-2522	57	3.938	5.125	0.500	100	130	13	21003-9724	58	3.000	4.250	0.625	76	108	16

All dimensions are in inches. Preferred sizes are indicated with **bold** type face. Sizes listed are for standard nitrile elements, except Models 25 and 62 which have PTFE elements. Other material available on inquiry only.

## Oil Seals by Model Number

Product Code	Model	Inches			MM			Product Code	Model	Inches			MM		
		ID	OD	Width	ID	OD	Width			ID	OD	Width	ID	OD	Width
21005-1819	58	2.500	3.500	0.375	64	89	10	24700-0090	59	10.500	12.000	0.625	267	305	16
21005-1862	58	4.724	5.512	0.512	120	140	13	24700-0094	59	10.625	11.813	0.625	270	300	16
21005-3045	58	6.000	6.750	0.375	152	171	10	24700-0095	59	10.625	12.125	0.750	270	308	19
24700-0001	59	7.283	8.850	0.625	185	225	16	24700-0096	59	10.625	12.375	0.750	270	314	19
24700-0002	59	8.000	10.000	0.625	203	254	16	24700-0097	59	10.625	12.500	0.750	270	318	19
24700-0004	59	8.125	10.125	0.625	206	257	16	24700-0098	59	10.625	13.000	0.750	270	330	19
24700-0005	59	8.250	10.250	0.625	210	260	16	24700-0100	59	10.750	12.000	0.625	273	305	16
24700-0006	59	8.250	10.500	0.875	210	267	22	24700-0102	59	10.750	12.500	0.625	273	318	16
24700-0007	59	8.250	11.500	0.750	210	292	19	24700-0104	59	10.875	12.375	0.750	276	314	19
24700-0008	59	8.375	9.750	0.625	213	248	16	24700-0106	59	11.000	12.250	0.625	279	311	16
24700-0009	59	8.375	9.875	0.625	213	251	16	24700-0107	59	11.000	13.000	0.625	279	330	16
24700-0010	59	8.375	10.375	0.750	213	264	19	24700-0108	59	11.024	12.197	0.629	280	310	16
24700-0012	59	8.500	10.000	0.625	216	254	16	24700-0109	59	11.024	13.386	0.984	280	340	25
24700-0013	59	8.500	10.500	0.625	216	267	16	24700-0116	59	11.250	12.500	0.625	286	318	16
24700-0015	59	8.625	10.125	0.625	219	257	16	24700-0117	59	11.250	13.250	0.625	286	337	16
24700-0016	59	8.625	10.250	0.625	219	260	16	24700-0118	59	11.250	13.500	0.875	286	343	22
24700-0017	59	8.625	10.625	0.625	219	270	16	24700-0119	59	11.375	12.875	0.750	289	327	19
24700-0019	59	8.661	10.236	0.625	220	260	16	24700-0120	59	11.375	13.000	0.625	289	330	16
24700-0020	59	8.661	10.228	0.625	220	260	16	24700-0122	59	11.375	13.500	1.000	289	343	25
24700-0021	59	8.661	10.819	0.950	220	275	24	24700-0124	59	11.438	13.000	0.688	291	330	17
24700-0022	59	8.750	10.250	0.625	222	260	16	24700-0125	59	11.500	12.875	0.688	292	327	17
24700-0024	59	8.750	10.625	0.750	222	270	19	24700-0127	59	11.500	13.500	0.750	292	343	19
24700-0025	59	8.858	11.016	0.906	225	280	23	24700-0128	59	11.500	13.375	0.750	292	340	19
24700-0030	59	9.000	10.500	0.625	229	267	16	24700-0129	59	11.500	13.500	0.625	292	343	16
24700-0032	59	9.000	11.000	0.625	229	279	16	24700-0130	59	11.625	13.191	0.750	295	335	19
24700-0033	59	9.000	11.054	0.750	229	281	19	24700-0131	59	11.750	13.250	0.625	298	337	16
24700-0035	59	9.055	10.621	0.629	230	270	16	24700-0132	59	11.750	13.750	0.625	298	349	16
24700-0036	59	9.055	11.024	0.625	230	280	16	24700-0133	59	11.750	14.000	1.000	298	356	25
24700-0037	59	9.125	10.625	0.625	232	270	16	24700-0134	59	11.811	13.386	0.709	300	340	18
24700-0038	59	9.125	10.750	0.625	232	273	16	24700-0137	59	11.813	14.000	0.750	300	356	19
24700-0039	59	9.125	11.125	0.625	232	283	16	24700-0139	59	12.000	13.250	0.625	305	337	16
24700-0041	59	9.250	10.500	0.625	235	267	16	24700-0140	59	12.000	13.500	0.625	305	343	16
24700-0042	59	9.250	10.750	0.625	235	273	16	24700-0141	59	12.000	13.625	0.625	305	346	16
24700-0043	59	9.250	11.000	0.625	235	279	16	24700-0146	59	12.125	13.875	0.750	308	352	19
24700-0044	59	9.250	11.250	0.750	235	286	19	24700-0147	59	12.125	14.000	0.875	308	356	22
24700-0045	59	9.250	11.375	0.875	235	289	22	24700-0148	59	12.188	13.438	0.625	310	341	16
24700-0048	59	9.375	10.625	0.625	238	270	16	24700-0152	59	12.250	14.250	0.625	311	362	16
24700-0049	59	9.375	10.875	0.750	238	276	19	24700-0153	59	12.375	13.875	0.688	314	352	17
24700-0051	59	9.438	10.625	0.750	240	270	19	24700-0157	59	12.500	13.750	0.625	318	349	16
24700-0052	59	9.438	11.500	0.875	240	292	22	24700-0158	59	12.500	14.750	1.000	318	375	25
24700-0054	59	9.449	11.811	0.984	240	300	25	24700-0160	59	12.565	14.063	0.750	319	357	19
24700-0055	59	9.500	11.000	0.625	241	279	16	24700-0161	59	12.590	14.125	1.000	320	359	25
24700-0057	59	9.500	11.500	0.625	241	292	16	24700-0162	59	12.598	13.780	0.630	320	350	16
24700-0058	59	9.620	10.875	0.625	244	276	16	24700-0168	59	12.756	14.252	0.630	324	362	16
24700-0061	59	9.750	11.125	0.625	248	283	16	24700-0169	59	12.750	14.750	0.750	324	375	19
24700-0066	59	9.844	11.409	0.625	250	290	16	24700-0173	59	12.875	15.500	0.875	327	394	22
24700-0067	59	9.875	11.375	0.750	251	289	19	24700-0174	59	12.992	14.567	0.709	330	370	18
24700-0068	59	9.875	12.000	0.875	251	305	22	24700-0176	59	13.000	14.875	0.875	330	378	22
24700-0074	59	10.000	12.000	0.625	254	305	16	24700-0177	59	13.220	14.407	0.625	336	366	16
24700-0077	59	10.125	11.750	0.688	257	298	17	24700-0178	59	13.250	14.750	0.625	337	375	16
24700-0078	59	10.188	12.250	1.000	259	311	25	24700-0179	59	13.250	14.875	0.750	337	378	19
24700-0079	59	10.236	12.590	0.984	260	320	25	24700-0180	59	13.250	15.000	0.750	337	381	19
24700-0080	59	10.250	11.500	0.625	260	292	16	24700-0182	59	13.250	15.250	0.750	337	387	19
24700-0081	59	10.250	11.750	0.625	260	298	16	24700-0183	59	13.250	15.375	1.000	337	391	25
24700-0084	59	10.375	11.625	0.625	264	295	16	24700-0186	59	13.375	15.000	0.750	340	381	19
24700-0088	59	10.438	12.438	0.875	265	316	22	24700-0188	59	13.386	14.646	0.630	340	372	16

All dimensions are in inches. Preferred sizes are indicated with **bold** type face.

Sizes listed are for standard nitrile elements, except Models 25 and 62 which have PTFE elements. Other material available on inquiry only.

## Oil Seals by Model Number

Product Code	Model	Inches			MM			Product Code	Model	Inches			MM		
		ID	OD	Width	ID	OD	Width			ID	OD	Width	ID	OD	Width
24700-0189	59	13.386	14.961	0.689	340	380	18	24700-0307	59	17.500	19.000	0.625	445	483	16
24700-0199	59	13.750	15.250	0.625	349	387	16	24700-0309	59	17.500	19.500	0.688	445	495	17
24700-0200	59	13.750	15.500	0.750	349	394	19	24700-0312	59	17.625	19.125	0.750	448	486	19
24700-0203	59	13.750	16.000	0.875	349	406	22	24700-0314	59	17.625	19.375	0.750	448	492	19
24700-0204	59	13.780	15.354	0.709	350	390	18	24700-0316	59	17.750	19.750	0.750	451	502	19
24700-0211	59	13.938	16.000	0.875	354	406	22	24700-0318	59	17.818	19.750	0.750	453	502	19
24700-0212	59	14.000	15.500	0.625	356	394	16	24700-0319	59	17.818	20.500	1.000	453	521	25
24700-0213	59	14.000	15.563	0.750	356	395	19	24700-0321	59	17.875	19.875	0.750	454	505	19
24700-0214	59	14.000	15.625	0.625	356	397	16	24700-0322	59	18.000	19.500	0.688	457	495	17
24700-0215	59	14.000	15.750	0.688	356	400	17	24700-0323	59	18.000	19.750	0.750	457	502	19
24700-0217	59	14.000	16.000	0.750	356	406	19	24700-0325	59	18.000	20.000	0.750	457	508	19
24700-0219	59	14.000	16.625	0.625	356	422	16	24700-0330	59	18.250	19.750	0.750	464	502	19
24700-0223	59	14.188	15.750	0.750	360	400	19	24700-0333	59	18.375	19.875	0.688	467	505	17
24700-0225	59	14.188	16.188	0.813	360	411	21	24700-0340	59	18.750	20.250	0.750	476	514	19
24700-0227	59	14.250	15.750	0.750	362	400	19	24700-0343	59	18.750	20.750	0.750	476	527	19
24700-0228	59	14.250	16.000	0.875	362	406	22	24700-0345	59	19.000	20.500	0.750	483	521	19
24700-0229	59	14.250	16.250	0.813	362	413	21	24700-0346	59	19.000	21.000	0.875	483	533	22
24700-0231	59	14.370	15.938	0.709	365	405	18	24700-0349	59	19.250	21.000	0.750	489	533	19
24700-0232	59	14.375	15.875	0.750	365	403	19	24700-0352	59	19.375	21.000	0.812	492	533	21
24700-0233	59	14.375	16.000	0.688	365	406	17	24700-0355	59	19.500	21.500	0.750	495	546	19
24700-0234	59	14.500	16.500	0.750	368	419	19	24700-0357	59	19.750	21.750	0.875	502	552	22
24700-0235	59	14.625	16.125	0.750	371	410	19	24700-0362	59	20.000	21.500	0.625	508	546	16
24700-0238	59	14.688	16.188	0.625	373	411	16	24700-0363	59	20.000	21.750	0.750	508	552	19
24700-0239	59	14.750	16.260	0.625	375	413	16	24700-0364	59	20.000	22.126	1.024	508	562	26
24700-0240	59	14.750	16.500	0.688	375	419	17	24700-0367	59	20.250	22.250	0.875	514	565	22
24700-0246	59	14.906	17.000	0.875	379	432	22	24700-0369	59	20.250	22.500	0.875	514	572	22
24700-0247	59	14.961	16.535	0.787	380	420	20	24700-0370	59	20.438	22.500	0.750	519	572	19
24700-0248	59	15.000	16.500	0.688	381	419	17	24700-0373	59	20.750	22.750	0.750	527	578	19
24700-0250	59	15.000	17.500	0.875	381	445	22	24700-0381	59	21.000	22.750	0.750	533	578	19
24700-0252	59	15.125	16.750	0.750	384	425	19	24700-0382	59	21.000	23.000	0.625	533	584	16
24700-0253	59	15.250	16.750	0.688	387	425	17	24700-0386	59	21.250	23.000	0.750	540	584	19
24700-0254	59	15.250	17.250	0.750	387	438	19	24700-0387	59	21.250	23.250	0.625	540	591	16
24700-0257	59	15.375	17.250	0.750	391	438	19	24700-0390	59	21.500	23.250	0.750	546	591	19
24700-0260	59	15.500	16.875	0.625	394	429	16	24700-0391	59	21.500	23.500	0.750	546	597	19
24700-0261	59	15.500	17.500	0.750	394	445	19	24700-0395	59	21.625	23.625	0.875	549	600	22
24700-0265	59	15.630	17.126	0.748	397	435	19	24700-0397	59	21.750	23.750	0.750	552	603	19
24700-0266	59	15.625	17.625	0.875	397	448	22	24700-0400	59	21.750	24.750	1.000	552	629	25
24700-0268	59	15.748	17.717	0.709	400	450	18	24700-0401	59	22.000	24.000	0.750	559	610	19
24700-0270	59	15.750	17.250	0.688	400	438	17	24700-0404	59	22.250	24.250	0.875	565	616	22
24700-0275	59	15.875	17.875	0.750	403	454	19	24700-0406	59	22.375	24.368	0.875	568	619	22
24700-0277	59	16.000	17.500	0.688	406	445	17	24700-0407	59	22.375	24.375	0.875	568	619	22
24700-0279	59	16.000	18.000	0.750	406	457	19	24700-0411	59	22.500	24.250	0.750	572	616	19
24700-0282	59	16.250	17.750	0.625	413	451	16	24700-0416	59	22.750	24.750	0.875	578	629	22
24700-0284	59	16.250	18.250	1.000	413	464	25	24700-0418	59	23.000	24.500	0.750	584	622	19
24700-0287	59	16.375	18.375	1.000	416	467	25	24700-0419	59	23.000	24.750	0.750	584	629	19
24700-0289	59	16.500	18.000	0.750	419	457	19	24700-0420	59	23.000	25.000	0.875	584	635	22
24700-0290	59	16.500	18.250	0.750	419	464	19	24700-0421	59	23.000	25.375	0.875	584	645	22
24700-0291	59	16.500	18.500	0.750	419	470	19	24700-0422	59	23.000	25.500	0.875	584	648	22
24700-0295	59	16.535	18.110	0.787	420	460	20	24700-0424	59	23.250	25.250	0.750	591	641	19
24700-0296	59	16.750	18.250	0.688	425	464	17	24700-0427	59	23.500	25.500	0.875	597	648	22
24700-0300	59	17.000	18.500	0.625	432	470	16	24700-0433	59	23.875	26.000	0.875	606	660	22
24700-0301	59	17.000	19.000	0.750	432	483	19	24700-0434	59	24.000	25.500	0.750	610	648	19
24700-0302	59	17.000	19.250	1.000	432	489	25	24700-0435	59	24.000	26.000	0.750	610	660	19
24700-0304	59	17.000	19.500	0.875	432	495	22	24700-0436	59	24.000	26.250	1.000	610	667	25
24700-0305	59	17.250	18.750	0.750	438	476	19	24700-0437	59	24.000	26.500	1.000	610	673	25
24700-0306	59	17.250	19.250	0.938	438	489	24	24700-0439	59	24.375	26.375	0.750	619	670	19

All dimensions are in inches. Preferred sizes are indicated with **bold** type face.  
 Sizes listed are for standard nitrile elements, except Models 25 and 62 which have PTFE elements. Other material available on inquiry only.



## Oil Seals by Model Number

Product Code	Model	Inches			MM			Product Code	Model	Inches			MM		
		ID	OD	Width	ID	OD	Width			ID	OD	Width	ID	OD	Width
24700-0441	59	24.438	26.438	0.750	621	672	19	24700-0579	59	39.000	41.000	0.750	991	1041	19
24700-0443	59	25.000	26.500	0.750	635	673	19	24700-0583	59	40.000	42.000	0.875	1016	1067	22
24700-0444	59	25.000	27.000	0.875	635	686	22	24700-0584	59	40.500	42.500	0.875	1029	1080	22
24700-0445	59	25.000	27.375	0.875	635	695	22	24700-0585	59	40.500	43.000	0.875	1029	1092	22
24700-0450	59	25.250	27.250	0.875	641	692	22	24700-0586	59	41.500	43.500	0.875	1054	1105	22
24700-0454	59	25.500	27.500	0.750	648	699	19	24700-0589	59	42.250	44.250	1.000	1073	1124	25
24700-0456	59	25.750	27.250	0.750	654	692	19	24700-0590	59	43.000	45.000	0.875	1092	1143	22
24700-0460	59	26.000	27.625	0.750	660	702	19	24700-0592	59	43.750	45.750	0.875	1111	1162	22
24700-0464	59	26.378	28.189	0.748	670	716	19	24700-0593	59	44.000	46.000	0.875	1118	1168	22
24700-0466	59	26.375	28.375	1.000	670	721	25	24700-0594	59	44.000	46.500	0.875	1118	1181	22
24700-0467	59	26.500	28.000	0.750	673	711	19	24700-0595	59	44.000	47.000	1.250	1118	1194	32
24700-0470	59	27.000	29.000	0.750	686	737	19	24700-0601	59	46.500	48.500	0.875	1181	1232	22
24700-0475	59	27.500	29.500	0.875	699	749	22	24700-0602	59	47.000	49.000	0.875	1194	1245	22
24700-0476	59	27.625	29.125	0.750	702	740	19	24700-0604	59	48.250	50.250	0.875	1226	1276	22
24700-0479	59	27.875	29.815	0.875	708	757	22	24700-0607	59	50.000	52.000	0.875	1270	1321	22
24700-0480	59	28.000	29.500	0.750	711	749	19	24700-0614	59	57.875	60.000	0.938	1470	1524	24
24700-0482	59	28.000	29.813	0.750	711	757	19	24700-0616	59	61.250	63.250	1.000	1556	1607	25
24700-0483	59	28.000	30.000	0.875	711	762	22	24700-0687	59	6.875	7.875	0.500	175	200	13
24700-0485	59	28.000	30.500	0.875	711	775	22	24700-0782	59	17.000	19.000	1.000	432	483	25
24700-0492	59	28.750	30.750	0.875	730	781	22	24700-0811	59	4.250	5.500	0.625	108	140	16
24700-0493	59	29.000	30.500	0.750	737	775	19	24700-0820	59	28.000	30.500	1.000	711	775	25
24700-0494	59	29.000	31.000	0.875	737	787	22	24700-0821	59	25.000	27.500	1.000	635	699	25
24700-0497	59	29.134	30.709	0.650	740	780	17	24700-0823	59	17.500	19.000	0.688	445	483	17
24700-0498	59	29.500	31.500	0.750	749	800	19	24700-0824	59	21.438	23.188	0.750	545	589	19
24700-0499	59	29.500	32.000	0.875	749	813	22	24700-0826	59	29.500	31.500	0.875	749	800	22
24700-0504	59	30.000	32.000	0.750	762	813	19	24700-0844	59	6.750	8.250	0.563	171	210	14
24700-0506	59	30.000	32.500	0.875	762	826	22	24700-0982	59	11.024	12.205	0.630	280	310	16
24700-0508	59	30.500	32.500	0.750	775	826	19	24700-0986	59	23.375	25.375	0.813	594	645	21
24700-0509	59	30.500	33.000	0.750	775	838	19	24700-0992	59	14.173	15.354	0.709	360	390	18
24700-0510	59	30.500	33.500	0.875	775	851	22	24700-0999	59	12.205	13.780	0.787	310	350	20
24700-0512	59	31.000	33.000	0.875	787	838	22	24700-1000	59	12.992	15.354	0.984	330	390	25
24700-0514	59	31.250	33.250	0.750	794	845	19	24700-1006	59	30.000	32.000	0.875	762	813	22
24700-0515	59	31.750	33.750	0.875	806	857	22	24700-1020	59	16.250	17.750	0.688	413	451	17
24700-0516	59	32.000	34.000	0.875	813	864	22	24700-1024	59	6.000	7.500	0.625	152	191	16
24700-0519	59	32.313	34.500	0.875	821	876	22	24700-1043	59	33.859	35.433	0.787	860	900	20
24700-0520	59	32.500	34.500	0.875	826	876	22	24700-1044	59	25.590	27.165	0.787	650	690	20
24700-0522	59	33.000	34.500	0.750	838	876	19	24700-1068	59	8.250	10.250	0.750	210	260	19
24700-0525	59	33.000	34.625	0.750	838	879	19	24700-1070	59	24.803	26.750	0.875	630	679	22
24700-0526	59	33.000	34.630	0.750	838	880	19	24700-1134	59	5.512	6.693	0.630	140	170	16
24700-0528	59	33.000	35.000	0.750	838	889	19	24700-1135	59	22.000	24.000	0.875	559	610	22
24700-0531	59	33.500	35.500	0.875	851	902	22	24700-1239	59	7.250	8.750	0.625	184	222	16
24700-0532	59	33.500	36.000	0.875	851	914	22	24700-1246	59	19.685	21.654	0.866	500	550	22
24700-0536	59	34.000	36.000	0.875	864	914	22	24700-1247	59	18.898	20.866	0.787	480	530	20
24700-0538	59	34.000	36.500	0.875	864	927	22	24700-1255	59	13.500	16.500	1.000	343	419	25
24700-0542	59	34.500	36.000	0.750	876	914	19	24700-1331	59	16.535	18.504	0.866	420	470	22
24700-0545	59	35.000	37.000	0.813	889	940	21	24700-1332	59	15.748	17.481	0.787	400	444	20
24700-0547	59	35.250	38.250	0.750	895	972	19	24700-1343	59	9.375	11.000	0.625	238	279	16
24700-0552	59	36.000	38.500	0.875	914	978	22	24700-1741	59	8.625	10.500	0.750	219	267	19
24700-0559	59	37.000	39.000	0.875	940	991	22	24700-1867	59	17.000	19.000	0.813	432	483	21
24700-0560	59	37.250	39.250	0.875	946	997	22	24700-1868	59	12.250	14.250	0.813	311	362	21
24700-0562	59	37.500	39.000	0.875	953	991	22	24700-1869	59	12.250	14.000	0.875	311	356	22
24700-0563	59	37.500	39.500	0.750	953	1003	19	24700-1875	59	11.625	13.000	0.750	295	330	19
24700-0565	59	37.795	40.945	0.906	960	1040	23	24700-1892	59	14.174	15.748	0.788	360	400	20
24700-0568	59	38.000	40.000	0.875	965	1016	22	24700-1902	59	13.780	16.142	0.787	350	410	20
24700-0569	59	38.250	40.250	0.875	972	1022	22	24700-1904	59	11.250	12.750	0.750	286	324	19
24700-0577	59	38.500	41.000	1.000	978	1041	25	24700-1933	59	30.709	33.228	0.984	780	844	25

All dimensions are in inches. Preferred sizes are indicated with **bold** type face.

Sizes listed are for standard nitrile elements, except Models 25 and 62 which have PTFE elements. Other material available on inquiry only.

## Oil Seals by Model Number

Product Code	Model	Inches			MM			Product Code	Model	Inches			MM		
		ID	OD	Width	ID	OD	Width			ID	OD	Width	ID	OD	Width
24700-1959	59	43.500	45.500	0.875	1105	1156	22	24700-3464	59	6.750	8.250	0.625	171	210	16
24700-1966	59	12.598	14.173	0.709	320	360	18	24700-3489	59	27.165	28.740	0.787	690	730	20
24700-1971	59	27.000	29.000	1.000	686	737	25	24700-3490	59	13.780	15.748	0.669	350	400	17
24700-1977	59	20.000	22.000	0.750	508	559	19	24700-3492	59	7.000	8.000	0.625	178	203	16
24700-1991	59	21.000	23.000	0.750	533	584	19	24700-3500	59	7.000	8.500	0.625	178	216	16
24700-1992	59	21.250	23.250	0.750	540	591	19	24700-3501	59	7.000	8.500	0.750	178	216	19
24700-1997	59	28.500	30.500	0.750	724	775	19	24700-3512	59	7.125	8.500	0.625	181	216	16
24700-2018	59	13.625	14.875	0.688	346	378	17	24700-3535	59	20.866	23.228	0.984	530	590	25
24700-2022	59	15.938	18.000	0.750	405	457	19	24700-3539	59	20.000	21.250	0.625	508	540	16
24700-2043	59	7.480	8.661	0.591	190	220	15	24700-3544	59	7.500	8.500	0.625	191	216	16
24700-2044	59	9.469	10.625	0.625	241	270	16	24700-3548	59	7.500	8.750	0.625	191	222	16
24700-2049	59	15.354	17.717	0.984	390	450	25	24700-3552	59	7.500	9.000	0.625	191	229	16
24700-2099	59	7.480	9.055	0.630	190	230	16	24700-3573	59	70.000	72.000	0.875	1778	1829	22
24700-2126	59	20.000	21.500	0.875	508	546	22	24700-3578	59	7.750	9.250	0.625	197	235	16
24700-2183	59	7.677	9.055	0.591	195	230	15	24700-3588	59	7.875	9.375	0.625	200	238	16
24700-2189	59	9.725	11.750	0.625	247	298	16	24700-3596	59	8.000	9.250	0.625	203	235	16
24700-2229	59	20.000	21.500	0.688	508	546	17	24700-3606	59	8.250	9.500	0.625	210	241	16
24700-2493	59	15.875	17.500	0.750	403	445	19	24700-3613	59	11.250	13.250	0.813	286	337	21
24700-2521	59	41.625	44.000	0.875	1057	1118	22	24700-3631	59	8.375	9.750	0.750	213	248	19
24700-2543	59	28.740	31.260	0.984	730	794	25	24700-3640	59	9.500	10.750	0.625	241	273	16
24700-2565	59	16.500	18.500	0.813	419	470	21	24700-3660	59	10.000	11.000	0.563	254	279	14
24700-2569	59	11.500	13.000	0.688	292	330	17	24700-3665	59	10.500	11.750	0.625	267	298	16
24700-2654	59	19.635	21.635	0.813	499	550	21	24700-3667	59	20.866	22.835	0.866	530	580	22
24700-2703	59	4.331	5.512	0.551	110	140	14	24700-3682	59	10.750	11.750	0.563	273	298	14
24700-2724	59	21.654	23.622	0.866	550	600	22	24700-3685	59	10.750	12.250	0.563	273	311	14
24700-2726	59	15.748	17.717	0.748	400	450	19	24700-3693	59	11.000	12.500	0.625	279	318	16
24700-2765	59	4.500	6.000	0.500	114	152	13	24700-3695	59	11.024	12.598	0.787	280	320	20
24700-2906	59	11.500	13.000	0.750	292	330	19	24700-3699	59	37.500	39.500	0.875	953	1003	22
24700-2914	59	9.750	10.750	0.625	248	273	16	24700-3718	59	12.875	14.750	1.000	327	375	25
24700-2936	59	12.500	14.000	0.688	318	356	17	24700-3726	59	14.000	16.250	1.000	356	413	25
24700-2980	59	12.000	14.000	0.938	305	356	24	24700-3740	59	16.929	18.898	0.866	430	480	22
24700-2992	59	7.625	8.750	0.625	194	222	16	24700-3741	59	17.000	18.750	0.750	432	476	19
24700-3003	59	14.125	15.625	0.750	359	397	19	24700-3768	59	8.000	9.500	0.688	203	241	17
24700-3042	59	16.250	18.500	0.813	413	470	21	24700-3769	59	22.441	24.016	0.787	570	610	20
24700-3080	59	39.370	41.339	0.866	1000	1050	22	24700-3793	59	17.000	18.250	0.625	432	464	16
24700-3091	59	13.780	15.748	0.984	350	400	25	24700-3817	59	8.250	9.250	0.625	210	235	16
24700-3100	59	11.417	13.780	0.984	290	350	25	24700-3832	59	8.875	10.125	0.625	225	257	16
24700-3132	59	29.921	31.890	0.984	760	810	25	24700-3837	59	29.921	32.008	0.866	760	813	22
24700-3133	59	19.291	20.866	0.787	490	530	20	24700-3853	59	12.000	14.000	0.625	305	356	16
24700-3134	59	23.228	24.803	0.787	590	630	20	24700-3876	59	30.500	32.500	0.875	775	826	22
24700-3140	59	9.875	11.875	0.969	251	302	25	24700-3880	59	14.567	16.299	0.787	370	414	20
24700-3171	59	42.500	45.000	0.750	1080	1143	19	24700-3882	59	13.386	14.961	0.709	340	380	18
24700-3182	59	5.500	6.750	0.500	140	171	13	24700-3903	59	64.000	65.375	0.875	1626	1661	22
24700-3212	59	13.780	14.961	0.630	350	380	16	24700-3919	59	6.693	7.874	0.630	170	200	16
24700-3220	59	19.938	21.688	0.625	506	551	16	24700-3935	59	8.500	9.500	0.625	216	241	16
24700-3240	59	3.562	4.500	0.625	90	114	16	24700-3943	59	17.717	19.291	0.787	450	490	20
24700-3250	59	32.750	34.500	0.875	832	876	22	24700-3945	59	26.378	27.953	0.787	670	710	20
24700-3281	59	5.750	7.000	0.500	146	178	13	24700-3949	59	42.520	45.039	0.984	1080	1144	25
24700-3352	59	6.102	7.087	0.591	155	180	15	24700-3950	59	15.354	17.323	0.787	390	440	20
24700-3355	59	6.000	7.000	0.500	152	178	13	24700-3955	59	9.055	10.236	0.591	230	260	15
24700-3369	59	22.375	25.250	0.875	568	641	22	24700-3961	59	63.780	65.551	0.787	1620	1665	20
24700-3387	59	23.500	25.500	1.000	597	648	25	24700-3992	59	10.000	11.500	0.688	254	292	17
24700-3424	59	6.437	7.687	0.625	163	195	16	24700-4002	59	16.339	18.307	0.787	415	465	20
24700-3426	59	6.500	7.500	0.625	165	191	16	24700-4006	59	10.500	12.500	0.625	267	318	16
24700-3427	59	10.500	11.500	0.625	267	292	16	24700-4009	59	11.811	13.071	0.630	300	332	16
24700-3461	59	22.047	24.016	0.787	560	610	20	24700-4019	59	22.047	24.016	0.870	560	610	22

All dimensions are in inches. Preferred sizes are indicated with **bold** type face.  
 Sizes listed are for standard nitrile elements, except Models 25 and 62 which have PTFE elements. Other material available on inquiry only.

## Oil Seals by Model Number

Product Code	Model	Inches			MM			Product Code	Model	Inches			MM		
		ID	OD	Width	ID	OD	Width			ID	OD	Width	ID	OD	Width
24700-4028	59	11.024	12.598	0.709	280	320	18	24700-4496	59	12.500	14.000	0.625	318	356	16
24700-4029	59	12.402	13.976	0.709	315	355	18	24700-4501	59	8.438	10.000	0.625	214	254	16
24700-4035	59	9.055	10.629	0.551	230	270	14	24700-4503	59	9.000	10.000	0.625	229	254	16
24700-4038	59	6.299	7.874	0.551	160	200	14	24700-4505	59	9.000	10.250	0.625	229	260	16
24700-4039	59	7.087	8.662	0.630	180	220	16	24700-4508	59	18.110	19.685	0.787	460	500	20
24700-4041	59	12.250	13.750	0.625	311	349	16	24700-4512	59	16.142	17.717	0.787	410	450	20
24700-4043	59	9.843	11.024	0.551	250	280	14	24700-4514	59	21.654	24.016	0.984	550	610	25
24700-4047	59	19.685	21.260	0.787	500	540	20	24700-4515	59	9.750	11.000	0.625	248	279	16
24700-4049	59	10.250	11.250	0.500	260	286	13	24700-4516	59	28.740	31.102	0.984	730	790	25
24700-4051	59	11.375	13.000	0.750	289	330	19	24700-4517	59	25.591	27.953	0.984	650	710	25
24700-4056	59	11.811	13.543	0.787	300	344	20	24700-4518	59	22.622	25.984	0.984	575	660	25
24700-4058	59	12.796	14.370	0.630	325	365	16	24700-4519	59	23.622	25.590	0.866	600	650	22
24700-4066	59	22.047	23.780	0.787	560	604	20	24700-4525	59	20.472	22.205	0.866	520	564	22
24700-4072	59	12.000	14.000	0.813	305	356	21	24700-4534	59	16.750	18.500	0.688	425	470	17
24700-4082	59	12.500	14.500	0.750	318	368	19	24700-4555	59	14.625	16.000	0.625	371	406	16
24700-4090	59	12.750	14.750	1.000	324	375	25	24700-4578	59	30.315	33.268	1.094	770	845	28
24700-4093	59	13.000	14.500	0.688	330	368	17	24700-4583	59	34.000	37.000	0.875	864	940	22
24700-4095	59	13.000	14.625	0.750	330	371	19	24700-4584	59	38.000	40.000	0.625	965	1016	16
24700-4097	59	26.375	28.188	0.875	670	716	22	24700-4598	59	21.260	23.228	0.866	540	590	22
24700-4098	59	13.000	15.000	0.750	330	381	19	24700-4599	59	49.212	51.732	0.984	1250	1314	25
24700-4100	59	38.976	40.945	0.866	990	1040	22	24700-4600	59	17.874	19.874	0.844	454	505	21
24700-4127	59	13.500	15.500	0.750	343	394	19	24700-4612	59	12.000	13.500	0.688	305	343	17
24700-4137	59	41.732	43.307	0.787	1060	1100	20	24700-4626	59	27.250	29.250	0.875	692	743	22
24700-4142	59	14.500	16.000	0.688	368	406	17	24700-4646	59	19.500	21.750	0.875	495	552	22
24700-4147	59	14.750	16.250	0.688	375	413	17	24700-4671	59	31.890	34.409	0.984	810	874	25
24700-4155	59	15.000	17.000	0.750	381	432	19	24700-4672	59	26.378	28.898	0.984	670	734	25
24700-4162	59	15.500	17.000	0.750	394	432	19	24700-4673	59	17.323	19.291	0.866	440	490	22
24700-4180	59	16.000	18.000	0.813	406	457	21	24700-4674	59	14.961	16.693	0.787	380	424	20
24700-4188	59	17.000	18.500	0.688	432	470	17	24700-4755	59	13.780	14.961	0.787	350	380	20
24700-4216	59	18.500	20.500	0.875	470	521	22	24700-4763	59	9.056	10.630	0.630	230	270	16
24700-4231	59	20.000	22.000	0.625	508	559	16	24700-4764	59	20.472	22.205	0.787	520	564	20
24700-4241	59	22.441	24.409	0.984	570	620	25	24700-4767	59	10.040	11.418	0.630	255	290	16
24700-4243	59	22.047	24.409	0.984	560	620	25	24700-4803	59	9.125	10.375	0.625	232	264	16
24700-4244	59	25.591	27.756	0.787	650	705	20	24700-4824	59	37.402	39.922	0.985	950	1014	25
24700-4245	59	22.441	24.409	0.866	570	620	22	24700-4858	59	10.993	12.402	0.788	279	315	20
24700-4246	59	20.500	22.500	0.875	521	572	22	24700-4875	59	30.315	33.268	1.063	770	845	27
24700-4255	59	18.504	20.866	0.984	470	530	25	24700-4879	59	19.125	21.125	0.813	486	537	21
24700-4256	59	22.835	25.197	0.984	580	640	25	24700-4891	59	10.237	12.402	0.945	260	315	24
24700-4269	59	22.000	23.500	0.750	559	597	19	24700-4917	59	29.921	31.496	0.787	760	800	20
24700-4294	59	24.000	26.000	0.875	610	660	22	24700-4936	59	15.354	17.323	0.984	390	440	25
24700-4321	59	7.283	8.859	0.630	185	225	16	24700-4950	59	10.000	11.500	0.625	254	292	16
24700-4360	59	25.437	27.188	0.750	646	691	19	24700-4999	59	10.236	12.598	0.984	260	320	25
24700-4376	59	30.500	33.000	1.000	775	838	25	24700-5054	59	17.500	19.250	0.688	445	489	17
24700-4393	59	17.323	18.898	0.787	440	480	20	24700-5064	59	15.748	17.323	0.630	400	440	16
24700-4394	59	14.173	15.748	0.709	360	400	18	24700-5079	59	19.375	21.000	0.750	492	533	19
24700-4396	59	15.748	17.323	0.787	400	440	20	24700-5102	59	13.780	15.512	0.788	350	394	20
24700-4397	59	12.598	14.173	0.787	320	360	20	24700-5107	59	13.780	15.512	0.748	350	394	19
24700-4405	59	34.500	36.500	0.875	876	927	22	24700-5111	59	10.236	11.417	0.630	260	290	16
24700-4423	59	14.764	16.535	0.787	375	420	20	24700-5162	59	25.500	27.500	0.875	648	699	22
24700-4429	59	15.748	17.716	0.761	400	450	19	24700-5170	59	13.386	14.961	0.788	340	380	20
24700-4434	59	10.500	12.000	0.687	267	305	17	24700-5172	59	15.355	16.930	0.709	390	430	18
24700-4454	59	28.500	30.500	0.875	724	775	22	24700-5280	59	23.622	25.197	0.788	600	640	20
24700-4481	59	9.250	11.250	0.563	235	286	14	24700-5281	59	15.355	17.087	0.788	390	434	20
24700-4486	59	18.110	20.078	0.866	460	510	22	24700-5287	59	6.750	7.750	0.750	171	197	19
24700-4487	59	28.740	31.259	1.007	730	794	26	24700-5299	59	15.236	16.417	0.591	387	417	15
24700-4494	59	24.250	26.000	1.000	616	660	25	24700-5317	59	7.875	9.055	0.630	200	230	16

All dimensions are in inches. Preferred sizes are indicated with **bold** type face.

Sizes listed are for standard nitrile elements, except Models 25 and 62 which have PTFE elements. Other material available on inquiry only.

## Oil Seals by Model Number

Product Code	Model	Inches			MM			Product Code	Model	Inches			MM		
		ID	OD	Width	ID	OD	Width			ID	OD	Width	ID	OD	Width
24700-5324	59	7.468	8.468	0.688	190	215	17	24700-6508	59	19.000	21.000	0.813	483	533	21
24700-5335	59	5.906	7.086	0.551	150	180	14	24700-6530	59	22.438	24.000	0.750	570	610	19
24700-5339	59	9.843	11.024	0.591	250	280	15	24700-6536	59	27.953	30.433	0.866	710	773	22
24700-5357	59	8.661	9.842	0.594	220	250	15	24700-6547	59	14.960	17.000	0.750	380	432	19
24700-5359	59	9.449	10.630	0.594	240	270	15	24700-6554	59	20.250	22.500	0.750	514	572	19
24700-5377	59	22.375	25.250	1.125	568	641	29	24700-6590	59	25.250	27.250	0.750	641	692	19
24700-5421	59	15.500	17.500	0.812	394	445	21	24700-6612	59	26.772	28.740	0.787	680	730	20
24700-5428	59	29.921	32.441	0.984	760	824	25	24700-6646	59	8.875	10.875	0.750	225	276	19
24700-5429	59	10.236	11.811	0.787	260	300	20	24700-6726	59	63.377	65.748	0.875	1610	1670	22
24700-5438	59	20.866	22.441	0.787	530	570	20	24700-6808	59	10.000	11.250	0.625	254	286	16
24700-5440	59	20.945	22.520	0.787	532	572	20	24700-7059	59	18.500	20.500	0.750	470	521	19
24700-5441	59	13.976	15.551	0.787	355	395	20	24700-7157	59	8.250	9.750	0.750	210	248	19
24700-5442	59	28.937	30.512	0.787	735	775	20	24700-7263	59	11.500	12.750	0.625	292	324	16
24700-5447	59	47.500	49.500	0.875	1207	1257	22	24700-7268	59	6.693	7.875	0.590	170	200	15
24700-5452	59	21.063	22.638	0.787	535	575	20	24700-7320	59	10.750	12.500	0.875	273	318	22
24700-5465	59	10.750	12.750	0.625	273	324	16	24700-7388	59	7.875	9.055	0.591	200	230	15
24700-5466	59	14.961	17.323	0.984	380	440	25	24700-7805	59	13.000	14.500	0.625	330	368	16
24700-5477	59	13.780	16.142	0.984	350	410	25	24700-7832	59	11.250	12.750	0.625	286	324	16
24700-5525	59	12.992	14.724	0.787	330	374	20	24700-8655	59	10.630	12.205	0.630	270	310	16
24700-5559	59	23.622	25.591	0.984	600	650	25	24700-9477	59	20.000	22.000	0.875	508	559	22
24700-5560	59	31.496	34.015	0.984	800	864	25	24702-0041	59	9.250	10.500	0.625	235	267	16
24700-5581	59	12.125	13.875	0.687	308	352	17	24702-0042	59	9.250	10.750	0.625	235	273	16
24700-5595	59	35.500	38.000	1.000	902	965	25	24702-0044	59	9.250	11.250	0.750	235	286	19
24700-5617	59	18.000	20.250	1.000	457	514	25	24702-0057	59	9.500	11.500	0.625	241	292	16
24700-5620	59	35.433	38.583	0.906	900	980	23	24702-0080	59	10.250	11.500	0.625	260	292	16
24700-5625	59	7.087	8.465	0.625	180	215	16	24702-0102	59	10.750	12.500	0.625	273	318	16
24700-5693	59	12.205	14.173	0.984	310	360	25	24702-0106	59	11.000	12.250	0.625	279	311	16
24700-5694	59	14.567	16.339	0.787	370	415	20	24702-0108	59	11.024	12.197	0.629	280	310	16
24700-5711	59	13.750	15.750	1.000	349	400	25	24702-0119	59	11.375	12.875	0.750	289	327	19
24700-5740	59	13.250	15.250	1.000	337	387	25	24702-0126	59	11.500	13.000	0.625	292	330	16
24700-5802	59	11.688	13.000	0.750	297	330	19	24702-0129	59	11.500	13.500	0.625	292	343	16
24700-5814	59	9.055	10.630	0.591	230	270	15	24702-0157	59	12.500	13.750	0.625	318	349	16
24700-5910	59	24.250	26.250	1.000	616	667	25	24702-0159	59	12.500	15.000	0.812	318	381	21
24700-5920	59	27.953	29.921	0.787	710	760	20	24702-0169	59	12.750	14.750	0.750	324	375	19
24700-5932	59	9.438	11.500	1.000	240	292	25	24702-0199	59	13.750	15.250	0.625	349	387	16
24700-5935	59	30.709	32.283	0.787	780	820	20	24702-0200	59	13.750	15.500	0.750	349	394	19
24700-5938	59	11.125	13.375	0.750	283	340	19	24702-0204	59	13.779	15.354	0.709	350	390	18
24700-5946	59	9.875	11.750	0.875	251	298	22	24702-0212	59	14.000	15.500	0.625	356	394	16
24700-5972	59	23.750	25.750	1.000	603	654	25	24702-0217	59	14.000	16.000	0.750	356	406	19
24700-5987	59	14.563	16.000	0.625	370	406	16	24702-0218	59	14.000	16.500	0.813	356	419	21
24700-5994	59	16.750	18.000	0.750	425	457	19	24702-0234	59	14.500	16.500	0.750	368	419	19
24700-6044	59	9.620	10.625	0.625	244	270	16	24702-0236	59	14.625	16.250	0.750	371	413	19
24700-6105	59	20.143	22.250	0.875	512	565	22	24702-0240	59	14.750	16.500	0.688	375	419	17
24700-6127	59	14.875	16.750	0.687	378	425	17	24702-0247	59	14.961	16.535	0.787	380	420	20
24700-6152	59	10.500	13.375	0.750	267	340	19	24702-0255	59	15.313	17.313	0.688	389	440	17
24700-6180	59	9.063	10.750	0.750	230	273	19	24702-0270	59	15.750	17.250	0.688	400	438	17
24700-6267	59	6.875	8.250	0.625	175	210	16	24702-0283	59	16.250	18.000	0.625	413	457	16
24700-6300	59	15.821	17.500	0.688	402	445	17	24702-0289	59	16.500	18.000	0.750	419	457	19
24700-6343	59	11.811	13.386	0.630	300	340	16	24702-0295	59	16.535	18.110	0.787	420	460	20
24700-6386	59	8.750	10.000	0.625	222	254	16	24702-0301	59	17.000	19.000	0.750	432	483	19
24700-6401	59	13.250	14.500	0.625	337	368	16	24702-0345	59	19.000	20.500	0.750	483	521	19
24700-6402	59	14.961	16.693	0.562	380	424	14	24702-0362	59	20.000	21.500	0.625	508	546	16
24700-6427	59	63.752	65.748	0.875	1619	1670	22	24702-0371	59	20.500	22.000	0.750	521	559	19
24700-6477	59	13.312	14.375	0.625	338	365	16	24702-0375	59	20.866	22.835	0.787	530	580	20
24700-6497	59	20.472	22.835	0.984	520	580	25	24702-0391	59	21.500	23.500	0.750	546	597	19
24700-6501	59	10.750	12.750	0.812	273	324	21	24702-0416	59	22.750	24.750	0.875	578	629	22

All dimensions are in inches. Preferred sizes are indicated with **bold** type face.  
 Sizes listed are for standard nitrile elements, except Models 25 and 62 which have PTFE elements. Other material available on inquiry only.

## Oil Seals by Model Number

Product Code	Model	Inches			MM			Product Code	Model	Inches			MM		
		ID	OD	Width	ID	OD	Width			ID	OD	Width	ID	OD	Width
24702-0438	59	24.250	26.250	0.875	616	667	22	24702-4917	59	29.921	31.496	0.787	760	800	20
24702-0470	59	27.000	29.000	0.750	686	737	19	24702-5287	59	6.750	7.750	0.750	171	197	19
24702-0475	59	27.500	29.500	0.875	699	749	22	24702-5335	59	5.906	7.086	0.551	150	180	14
24702-0483	59	28.000	30.000	0.875	711	762	22	24702-5339	59	9.843	11.024	0.591	250	280	15
24702-0508	59	30.500	32.500	0.750	775	826	19	24702-5357	59	8.661	9.842	0.590	220	250	15
24702-0528	59	33.000	35.000	0.750	838	889	19	24702-5359	59	9.448	10.629	0.590	240	270	15
24702-0547	59	35.250	38.250	0.750	895	972	19	24702-5444	59	12.362	13.976	0.787	314	355	20
24702-0569	59	38.250	40.250	0.875	972	1022	22	24702-5497	59	24.250	25.750	0.750	616	654	19
24702-0594	59	44.000	46.500	0.875	1118	1181	22	24702-5595	59	35.500	38.000	1.000	902	965	25
24702-0602	59	47.000	49.000	0.875	1194	1245	22	24702-6041	59	48.250	50.000	0.750	1226	1270	19
24702-0620	59	15.000	16.500	0.750	381	419	19	24702-6444	59	10.000	11.250	0.563	254	286	14
24702-1024	59	6.000	7.500	0.625	152	191	16	24702-6452	59	11.500	13.500	0.750	292	343	19
24702-1246	59	19.685	21.654	0.866	500	550	22	24702-6584	59	24.803	26.378	0.750	630	670	19
24702-1247	59	18.898	20.866	0.787	480	530	20	24702-6808	59	10.000	11.250	0.625	254	286	16
24702-1332	59	15.748	17.480	0.787	400	444	20	24702-7059	59	18.500	20.500	0.750	470	521	19
24702-1892	59	14.174	15.748	0.788	360	400	20	24702-8655	59	10.630	12.205	0.630	270	310	16
24702-1931	59	22.750	25.500	0.875	578	648	22	24702-9532	59	24.750	26.750	0.625	629	679	16
24702-1977	59	20.000	22.000	0.750	508	559	19	24703-0012	59	8.500	10.000	0.625	216	254	16
24702-1991	59	21.000	23.000	0.750	533	584	19	24703-0289	59	16.500	18.000	0.750	419	457	19
24702-2100	59	9.449	11.024	0.630	240	280	16	24703-0314	59	17.625	19.375	0.750	448	492	19
24702-2496	59	13.000	14.500	0.750	330	368	19	24703-0490	59	28.500	30.500	0.625	724	775	16
24702-2565	59	16.500	18.500	0.813	419	470	21	24703-0951	59	5.125	6.250	0.500	130	159	13
24702-2620	59	10.688	12.500	0.625	271	318	16	24703-4463	59	49.500	51.500	0.750	1257	1308	19
24702-2703	59	4.331	5.512	0.551	110	140	14	24707-0005	59	8.250	10.250	0.625	210	260	16
24702-2970	59	10.750	12.750	0.750	273	324	19	24707-0174	59	12.992	14.566	0.708	330	370	18
24702-3150	59	9.000	10.500	0.688	229	267	17	24707-0174	59	12.992	14.566	0.708	330	370	18
24702-3256	59	22.000	23.750	0.875	559	603	22	24707-0261	59	15.500	17.500	0.750	394	445	19
24702-3370	59	6.000	7.500	0.750	152	191	19	24707-0291	59	16.500	18.500	0.750	419	470	19
24702-3428	59	23.750	25.250	0.875	603	641	22	24707-0301	59	17.000	19.000	0.750	432	483	19
24702-3492	59	7.000	8.000	0.625	178	203	16	24707-0309	59	17.500	19.500	0.688	445	495	17
24702-3665	59	10.500	11.750	0.625	267	298	16	24707-0325	59	18.000	20.000	0.750	457	508	19
24702-3675	59	10.000	11.000	0.688	254	279	17	24707-0371	59	20.500	22.000	0.750	521	559	19
24702-3691	59	11.000	12.000	0.625	279	305	16	24707-0382	59	21.000	23.000	0.625	533	584	16
24702-3692	59	11.000	12.375	0.750	279	314	19	24707-0404	59	22.250	24.250	0.875	565	616	22
24702-3720	59	11.000	12.250	0.688	279	311	17	24707-0406	59	22.375	24.368	0.875	568	619	22
24702-3853	59	12.000	14.000	0.625	305	356	16	24707-0467	59	26.500	28.000	0.750	673	711	19
24702-3919	59	6.693	7.875	0.630	170	200	16	24707-0470	59	27.000	29.000	0.750	686	737	19
24702-3924	59	8.000	10.000	0.688	203	254	17	24707-0475	59	27.500	29.500	0.875	699	749	22
24702-3992	59	10.000	11.500	0.688	254	292	17	24707-0483	59	28.000	30.000	0.875	711	762	22
24702-4006	59	10.500	12.500	0.625	267	318	16	24707-0494	59	29.000	31.000	0.875	737	787	22
24702-4010	59	15.748	17.717	0.787	400	450	20	24707-0515	59	31.750	33.750	0.875	806	857	22
24702-4029	59	12.402	13.976	0.709	315	355	18	24707-0520	59	32.500	34.500	0.875	826	876	22
24702-4049	59	10.250	11.250	0.500	260	286	13	24707-0583	59	40.000	42.000	0.875	1016	1067	22
24702-4093	59	13.000	14.500	0.688	330	368	17	24707-0586	59	41.500	43.500	0.875	1054	1105	22
24702-4127	59	13.500	15.500	0.750	343	394	19	24707-0614	59	57.875	60.000	0.938	1470	1524	24
24702-4142	59	14.500	16.000	0.688	368	406	17	24707-0999	59	12.204	13.780	0.787	310	350	20
24702-4180	59	16.000	18.000	0.813	406	457	21	24707-1000	59	12.992	15.354	0.984	330	390	25
24702-4216	59	18.500	20.500	0.875	470	521	22	24707-1135	59	22.000	24.000	0.875	559	610	22
24702-4349	59	8.938	10.437	0.750	227	265	19	24707-3132	59	29.921	31.890	0.984	760	810	25
24702-4393	59	17.323	18.898	0.787	440	480	20	24707-3133	59	19.291	20.866	0.787	490	530	20
24702-4397	59	12.598	14.173	0.787	320	360	20	24707-3134	59	23.228	24.803	0.787	590	630	20
24702-4423	59	14.764	16.535	0.787	375	420	20	24707-3279	59	26.500	28.000	0.875	673	711	22
24702-4434	59	10.500	12.000	0.688	267	305	17	24707-3520	59	43.000	45.000	0.750	1092	1143	19
24702-4528	59	12.250	13.813	0.625	311	351	16	24707-3832	59	8.875	10.125	0.625	225	257	16
24702-4584	59	38.000	40.000	0.625	965	1016	16	24707-3837	59	29.921	32.008	0.866	760	813	22
24702-4606	59	6.750	7.750	0.625	171	197	16	24707-3945	59	26.378	27.953	0.787	670	710	20
								24707-4051	59	11.375	13.000	0.750	289	330	19

All dimensions are in inches. Preferred sizes are indicated with **bold** type face.

Sizes listed are for standard nitrile elements, except Models 25 and 62 which have PTFE elements. Other material available on inquiry only.

## Oil Seals by Model Number

Product Code	Model	Inches			MM			Product Code	Model	Inches			MM		
		ID	OD	Width	ID	OD	Width			ID	OD	Width	ID	OD	Width
24707-4098	59	13.000	15.000	0.750	330	381	19	24715-0967	59	5.750	6.875	0.500	146	175	13
24707-4180	59	16.000	18.000	0.813	406	457	21	24715-1164	59	17.750	19.750	1.000	451	502	25
24707-4429	59	15.748	17.716	0.761	400	450	19	24715-1239	59	7.250	8.750	0.625	184	222	16
24707-4508	59	18.110	19.685	0.787	460	500	20	24715-1246	59	19.685	21.654	0.866	500	550	22
24707-4578	59	30.315	33.268	1.094	770	845	28	24715-1895	59	7.750	8.750	0.625	197	222	16
24707-5429	59	10.236	11.811	0.866	260	300	22	24715-1991	59	21.000	23.000	0.750	533	584	19
24709-0344	59	18.897	20.464	0.787	480	520	20	24715-2620	59	10.688	12.500	0.625	271	318	16
24709-0602	59	47.000	49.000	0.875	1194	1245	22	24715-2724	59	21.654	23.622	0.866	550	600	22
24715-0003	59	8.063	10.062	1.000	205	256	25	24715-2981	59	20.000	22.000	1.000	508	559	25
24715-0005	59	8.250	10.250	0.625	210	260	16	24715-2991	59	37.795	40.157	0.875	960	1020	22
24715-0012	59	8.500	10.000	0.625	216	254	16	24715-3080	59	39.370	41.338	0.875	1000	1050	22
24715-0041	59	9.250	10.500	0.625	235	267	16	24715-3256	59	22.000	23.750	0.875	559	603	22
24715-0042	59	9.250	10.750	0.625	235	273	16	24715-3281	59	5.750	7.000	0.500	146	178	13
24715-0064	59	9.750	11.750	0.625	248	298	16	24715-3367	59	6.000	7.500	0.500	152	191	13
24715-0076	59	10.125	11.625	0.688	257	295	17	24715-3424	59	6.437	7.688	0.625	163	195	16
24715-0082	59	10.250	12.000	0.625	260	305	16	24715-3427	59	10.500	11.500	0.625	267	292	16
24715-0084	59	10.375	11.625	0.625	264	295	16	24715-3435	59	6.500	8.000	0.750	165	203	19
24715-0090	59	10.500	12.000	0.625	267	305	16	24715-3454	59	12.366	14.500	0.750	314	368	19
24715-0131	59	11.750	13.250	0.625	298	337	16	24715-3461	59	22.047	24.016	0.787	560	610	20
24715-0140	59	12.000	13.500	0.625	305	343	16	24715-3492	59	7.000	8.000	0.625	178	203	16
24715-0178	59	13.250	14.750	0.625	337	375	16	24715-3500	59	7.000	8.500	0.625	178	216	16
24715-0179	59	13.250	14.875	0.750	337	378	19	24715-3501	59	7.000	8.500	0.750	178	216	19
24715-0189	59	13.386	14.960	0.688	340	380	17	24715-3527	59	7.250	8.750	0.750	184	222	19
24715-0199	59	13.750	15.250	0.625	349	387	16	24715-3531	59	7.250	8.500	0.750	184	216	19
24715-0204	59	13.779	15.354	0.709	350	390	18	24715-3544	59	7.500	8.500	0.625	191	216	16
24715-0212	59	14.000	15.500	0.625	356	394	16	24715-3548	59	7.500	8.750	0.625	191	222	16
24715-0229	59	14.250	16.250	0.813	362	413	21	24715-3552	59	7.500	9.000	0.625	191	229	16
24715-0248	59	15.000	16.500	0.688	381	419	17	24715-3578	59	7.750	9.250	0.625	197	235	16
24715-0261	59	15.500	17.500	0.750	394	445	19	24715-3588	59	7.875	9.375	0.625	200	238	16
24715-0287	59	16.375	18.375	1.000	416	467	25	24715-3596	59	8.000	9.250	0.625	203	235	16
24715-0289	59	16.500	18.000	0.750	419	457	19	24715-3631	59	8.375	9.750	0.750	213	248	19
24715-0295	59	16.535	18.110	0.787	420	460	20	24715-3640	59	9.500	10.750	0.625	241	273	16
24715-0345	59	19.000	20.500	0.750	483	521	19	24715-3665	59	10.500	11.750	0.625	267	298	16
24715-0348	59	19.250	20.750	0.750	489	527	19	24715-3682	59	10.750	11.750	0.563	273	298	14
24715-0361	59	19.938	21.688	0.625	506	551	16	24715-3693	59	11.000	12.500	0.625	279	318	16
24715-0371	59	20.500	22.000	0.750	521	559	19	24715-3726	59	14.000	16.250	1.000	356	413	25
24715-0390	59	21.500	23.250	0.750	546	591	19	24715-3740	59	16.929	18.898	0.866	430	480	22
24715-0433	59	23.875	26.000	0.875	606	660	22	24715-3832	59	8.875	10.125	0.625	225	257	16
24715-0436	59	24.000	26.250	1.000	610	667	25	24715-3908	59	7.874	9.252	0.630	200	235	16
24715-0461	59	26.000	28.000	0.750	660	711	19	24715-3920	59	7.087	8.268	0.630	180	210	16
24715-0463	59	26.125	28.125	0.813	664	714	21	24715-3921	59	7.188	8.639	0.625	183	219	16
24715-0467	59	26.500	28.000	0.750	673	711	19	24715-3925	59	8.000	10.000	0.750	203	254	19
24715-0478	59	27.875	29.812	0.875	708	757	22	24715-3935	59	8.500	9.500	0.625	216	241	16
24715-0479	59	27.875	29.815	0.875	708	757	22	24715-4047	59	19.685	21.260	0.787	500	540	20
24715-0480	59	28.000	29.500	0.750	711	749	19	24715-4052	59	11.811	13.386	0.787	300	340	20
24715-0490	59	28.500	30.500	0.625	724	775	16	24715-4058	59	12.795	14.370	0.630	325	365	16
24715-0498	59	29.500	31.500	0.875	749	800	22	24715-4072	59	12.000	14.000	0.813	305	356	21
24715-0528	59	33.000	35.000	0.750	838	889	19	24715-4142	59	14.500	16.000	0.688	368	406	17
24715-0547	59	35.250	38.250	0.750	895	972	19	24715-4207	59	25.500	27.000	0.875	648	686	22
24715-0560	59	37.250	39.250	0.875	946	997	22	24715-4234	59	13.000	14.250	0.688	330	362	17
24715-0584	59	40.500	42.500	0.875	1029	1080	22	24715-4243	59	22.047	24.409	0.984	560	620	25
24715-0585	59	40.500	43.000	0.875	1029	1092	22	24715-4244	59	25.591	27.756	0.787	650	705	20
24715-0592	59	43.750	45.750	0.875	1111	1162	22	24715-4246	59	20.500	22.500	0.875	521	572	22
24715-0604	59	48.250	50.250	0.875	1226	1276	22	24715-4256	59	22.835	25.197	0.984	580	640	25
24715-0697	59	7.750	8.750	0.500	197	222	13	24715-4397	59	12.598	14.173	0.787	320	360	20
24715-0825	59	26.125	28.125	0.875	664	714	22	24715-4401	59	9.500	10.500	0.625	241	267	16

All dimensions are in inches. Preferred sizes are indicated with **bold** type face. Sizes listed are for standard nitrile elements, except Models 25 and 62 which have PTFE elements. Other material available on inquiry only.

## Oil Seals by Model Number

Product Code	Model	Inches			MM			Product Code	Model	Inches			MM		
		ID	OD	Width	ID	OD	Width			ID	OD	Width	ID	OD	Width
24715-4404	59	9.688	10.875	0.625	246	276	16	24716-6044	59	9.620	10.625	0.625	244	270	16
24715-4405	59	34.500	36.500	0.875	876	927	22	24716-8655	59	10.630	12.205	0.630	270	310	16
24715-4486	59	18.110	20.079	0.866	460	510	22	24717-0012	59	8.500	10.000	0.625	216	254	16
24715-4509	59	15.748	17.748	0.625	400	451	16	24717-0436	59	24.000	26.250	1.000	610	667	25
24715-4514	59	21.654	24.016	0.984	550	610	25	24717-2981	59	20.000	22.000	1.000	508	559	25
24715-4517	59	25.591	27.953	0.984	650	710	25	24717-3163	59	26.180	28.701	0.875	665	729	22
24715-4628	59	31.750	33.250	0.750	806	845	19	24717-3571	59	17.000	19.000	1.250	432	483	32
24715-4814	59	24.921	26.671	0.803	633	677	20	24717-4180	59	16.000	18.000	0.813	406	457	21
24715-4823	59	7.625	8.625	0.625	194	219	16	24717-5085	59	38.976	40.945	0.679	990	1040	17
24715-5170	59	13.386	14.961	0.787	340	380	20	24717-5086	59	42.520	45.039	0.797	1080	1144	20
24715-5284	59	7.125	8.375	0.625	181	213	16	24717-5294	59	8.661	10.236	0.562	220	260	14
24715-5300	59	31.000	32.500	0.750	787	826	19	24718-0520	59	32.500	34.500	0.875	826	876	22
24715-5323	59	7.125	8.250	0.750	181	210	19	24718-0982	59	11.024	12.205	0.630	280	310	16
24715-5335	59	5.906	7.087	0.551	150	180	14	24718-3408	59	12.205	13.780	0.709	310	350	18
24715-5359	59	9.449	10.630	0.591	240	270	15	24718-5280	59	23.622	25.197	0.787	600	640	20
24715-5378	59	7.188	8.500	0.500	183	216	13	24736-0371	59	20.500	22.000	0.750	521	559	19
24715-5407	59	7.812	10.062	1.000	198	256	25	24736-0382	59	21.000	23.000	0.625	533	584	16
24715-5447	59	47.500	49.500	0.875	1207	1257	22	24736-0462	59	26.000	28.500	0.875	660	724	22
24715-5453	59	8.465	9.843	0.630	215	250	16	24736-0475	59	27.500	29.500	0.875	699	749	22
24715-5465	59	10.750	12.750	0.625	273	324	16	24736-0475	59	22.000	24.000	0.875	559	610	22
24715-5525	59	12.992	14.724	0.787	330	374	20	24736-1135	59	16.000	18.000	0.812	406	457	21
24715-5531	59	51.250	53.211	0.812	1302	1352	21	24736-4180	59	16.000	18.000	0.812	406	457	21
24715-5532	59	45.000	47.000	0.812	1143	1194	21	24736-4239	59	27.953	30.472	0.866	710	774	22
24715-5574	59	31.375	33.250	0.625	797	845	16	24736-4240	59	38.976	40.945	0.984	990	1040	25
24715-5575	59	31.375	33.250	0.750	797	845	19	24736-4245	59	22.441	24.409	0.866	570	620	22
24715-5603	59	12.000	14.360	0.750	305	365	19	24736-4246	59	20.500	22.500	0.875	521	572	22
24715-5609	59	29.134	31.102	0.984	740	790	25	24736-4252	59	16.929	18.504	0.787	430	470	20
24715-5728	59	33.000	36.000	1.000	838	914	25	24736-4253	59	16.929	18.898	0.984	430	480	25
24715-5925	59	12.598	14.173	0.984	320	360	25	24736-4455	59	38.189	40.709	0.874	970	1034	22
24715-5926	59	11.024	13.386	1.102	280	340	28	24736-4508	59	18.110	19.685	0.787	460	500	20
24715-5928	59	34.488	36.500	0.875	876	927	22	24736-5464	59	17.717	20.079	0.984	450	510	25
24715-5949	59	19.685	21.654	0.709	500	550	18	24739-0475	59	27.500	29.500	0.875	699	749	22
24715-5994	59	16.750	18.000	0.750	425	457	19	24739-0583	59	40.000	42.000	0.875	1016	1067	22
24715-5995	59	14.750	16.500	0.812	375	419	21	24739-1135	59	22.000	24.000	0.875	559	610	22
24715-6091	59	25.375	27.375	0.750	645	695	19	24742-0214	59	14.000	15.625	0.625	356	397	16
24715-6121	59	12.992	14.961	0.866	330	380	22	24742-0416	59	22.750	24.750	0.875	578	629	22
24715-6284	59	11.614	12.992	0.688	295	330	17	24742-0467	59	26.500	28.000	0.750	673	711	19
24715-6632	59	29.528	31.496	0.984	750	800	25	24742-0510	59	30.500	33.500	0.875	775	851	22
24715-6637	59	35.433	37.402	0.984	900	950	25	24742-0614	59	57.875	60.000	0.938	1470	1524	24
24715-6808	59	10.000	11.250	0.625	254	286	16	24742-3520	59	43.000	45.000	0.750	1092	1143	19
24715-7388	59	7.874	9.055	0.591	200	230	15	24742-4051	59	11.375	13.000	0.750	289	330	19
24716-0382	59	21.000	23.000	0.625	533	584	16	24742-4098	59	13.000	15.000	0.750	330	381	19
24716-0551	59	36.000	38.000	0.875	914	965	22	24742-4180	59	16.000	18.000	0.813	406	457	21
24716-1332	59	15.748	17.481	0.787	400	444	20	24742-4294	59	24.000	26.000	0.875	610	660	22
24716-1892	59	14.174	15.748	0.788	360	400	20	24742-5277	59	11.811	13.543	0.661	300	344	17
24716-2724	59	21.654	23.622	0.866	550	600	22	24742-5278	59	14.961	16.693	0.661	380	424	17
24716-3526	59	8.268	9.843	0.591	210	250	15	24742-6425	59	49.212	51.732	0.859	1250	1314	22
24716-3740	59	16.929	18.898	0.866	430	480	22	24743-0404	59	22.250	24.250	0.875	565	616	22
24716-4038	59	6.299	7.874	0.551	160	200	14	24743-0509	59	30.500	33.000	0.750	775	838	19
24716-4039	59	7.087	8.662	0.630	180	220	16	24743-0579	59	39.000	41.000	0.750	991	1041	19
24716-4040	59	5.709	7.087	0.591	145	180	15	24743-0584	59	40.500	42.500	0.875	1029	1080	22
24716-4042	59	11.417	12.992	0.630	290	330	16	24743-0585	59	40.500	43.000	0.875	1029	1092	22
24716-4043	59	9.843	11.024	0.551	250	280	14	24743-0586	59	41.500	43.500	0.875	1054	1105	22
24716-4058	59	12.795	14.370	0.630	325	365	16	24743-0602	59	47.000	49.000	0.875	1194	1245	22
24716-5054	59	17.500	19.250	0.688	445	489	17	24743-0604	59	48.250	50.250	0.875	1226	1276	22
24716-5357	59	8.661	9.843	0.591	220	250	15	24743-0999	59	12.204	13.780	0.787	310	350	20
								24743-1000	59	12.992	15.354	0.984	330	390	25

All dimensions are in inches. Preferred sizes are indicated with **bold** type face.

Sizes listed are for standard nitrile elements, except Models 25 and 62 which have PTFE elements. Other material available on inquiry only.

## Oil Seals by Model Number

Product Code	Model	Inches			MM			Product Code	Model	Inches			MM		
		ID	OD	Width	ID	OD	Width			ID	OD	Width	ID	OD	Width
24743-3876	59	30.500	32.500	0.875	775	826	22	24781-3999	59	14.173	15.945	0.984	360	405	25
24743-4180	59	16.000	18.000	0.813	406	457	21	24781-4001	59	33.465	35.433	0.866	850	900	22
24743-4429	59	15.748	17.717	.761	400	450	19	24781-4004	59	46.457	48.976	0.984	1180	1244	25
24743-4434	59	10.500	12.000	0.687	267	305	17	24781-4011	59	24.803	26.378	0.787	630	670	20
24743-4454	59	28.500	30.500	0.875	724	775	22	24781-4027	59	29.134	30.709	0.787	740	780	20
24743-5277	59	11.811	13.543	0.661	300	344	17	24782-0247	59	14.961	16.535	0.787	380	420	20
24743-5278	59	14.961	16.693	0.661	380	424	17	24782-4009	59	11.810	13.070	0.630	300	332	16
24743-5357	59	8.661	9.843	0.591	220	250	15	24782-4030	59	7.480	9.055	0.591	190	230	15
24743-5421	59	15.500	17.500	0.812	394	445	21	24782-4073	59	10.433	12.205	0.629	265	310	16
24743-5429	59	10.236	11.811	0.787	260	300	20	24782-4365	59	6.890	8.071	0.591	175	205	15
24743-6402	59	14.961	16.693	0.562	380	424	14	24782-4416	59	6.889	8.071	0.591	175	205	15
24744-0387	59	21.250	23.250	0.625	540	591	16	24782-5339	59	9.842	11.023	0.590	250	280	15
24744-6522	59	25.375	28.500	0.906	645	724	23	24782-7388	59	7.874	9.055	0.591	200	230	15
24745-0406	59	22.375	24.368	0.875	568	619	22	24783-4009	59	11.810	13.070	0.630	300	332	16
24745-0604	59	48.250	50.250	0.875	1226	1276	22	24783-4030	59	7.480	9.055	0.591	190	230	15
24745-3837	59	29.921	32.008	0.866	760	813	22	24783-4073	59	10.433	12.205	0.629	265	310	16
24745-5429	59	10.236	11.812	0.787	260	300	20	24783-5339	59	9.842	11.023	0.590	250	280	15
24747-0212	59	14.000	15.500	0.625	356	394	16	24056-1761	61	0.984	1.653	0.315	25	42	8
24747-0382	59	21.000	23.000	0.625	533	584	16	24056-1776	61	1.260	1.850	0.315	32	47	8
24747-0443	59	25.000	26.500	0.750	635	673	19	24056-1787	61	1.378	1.850	0.315	35	47	8
24747-0584	59	40.500	42.500	0.875	1029	1080	22	24056-1814	61	1.969	2.559	0.394	50	65	10
24747-1991	59	21.000	23.000	0.750	533	584	19	24056-1912	61	1.575	2.362	0.394	40	60	10
24747-5429	59	10.236	11.811	0.787	260	300	20	24056-1931	61	1.575	2.165	0.394	40	55	10
24748-3876	59	30.500	32.500	0.875	775	826	22	24056-6374	61	7.000	8.000	0.500	178	203	13
24748-4180	59	16.000	18.000	0.813	406	457	21	24060-0005	61	0.312	0.750	0.250	8	19	6
24748-4434	59	10.500	12.000	0.688	267	305	17	24060-0013	61	0.375	0.750	0.250	10	19	6
24756-0512	59	31.000	33.000	0.875	787	838	22	24060-0015	61	0.375	0.875	0.250	10	22	6
24756-3133	59	19.291	20.866	0.787	490	530	20	24060-0017	61	0.375	1.000	0.312	10	25	8
24756-5277	59	11.811	13.543	0.661	300	344	17	24060-0023	61	0.375	1.375	0.312	10	35	8
24756-5278	59	14.961	16.693	0.661	380	424	17	24060-0024	61	0.472	1.102	0.276	12	28	7
24756-6497	59	20.472	22.835	0.984	520	580	25	24060-0049	61	0.500	1.000	0.312	13	25	8
24765-2724	59	21.654	23.622	0.866	550	600	22	24060-0055	61	0.500	1.375	0.312	13	35	8
24765-5121	59	17.250	18.750	0.625	438	476	16	24060-0070	61	0.563	1.250	0.375	14	32	10
24765-5130	59	16.535	18.110	0.625	420	460	16	24060-0074	61	0.709	1.181	0.276	18	30	7
24768-5085	59	38.976	40.945	0.679	990	1040	17	24060-0087	61	0.625	1.125	0.312	16	29	8
24768-5086	59	42.520	45.039	0.797	1080	1144	20	24060-0089	61	0.625	1.250	0.312	16	32	8
24769-4028	59	11.024	12.598	0.709	280	320	18	24060-0090	61	0.625	1.250	0.375	16	32	10
24769-5111	59	10.236	11.417	0.630	260	290	16	24060-0091	61	0.625	1.375	0.312	16	35	8
24769-5928	59	34.488	36.500	0.875	876	927	22	24060-0093	61	0.625	1.500	0.313	16	38	8
24769-5949	59	19.685	21.654	0.709	500	550	18	24060-0109	61	0.687	1.125	0.312	17	29	8
24772-4255	59	18.504	20.866	0.984	470	530	25	24060-0120	61	0.787	1.181	0.276	20	30	7
24772-5925	59	12.598	14.173	0.984	320	360	25	24060-0132	61	1.575	2.441	0.315	40	62	8
24774-0579	59	39.000	41.000	0.750	991	1041	19	24060-0139	61	0.750	1.250	0.312	19	32	8
24780-1896	59	14.567	16.142	0.787	370	410	20	24060-0141	61	0.750	1.375	0.312	19	35	8
24780-3352	59	6.102	7.087	0.591	155	180	15	24060-0143	61	0.750	1.500	0.312	19	38	8
24780-3678	59	24.409	26.378	0.866	620	670	22	24060-0147	61	0.750	1.625	0.312	19	41	8
24780-4002	59	16.339	18.307	0.787	415	465	20	24060-0149	61	0.750	1.750	0.375	19	44	10
24780-4004	59	46.457	48.976	0.984	1180	1244	25	24060-0183	61	0.812	1.625	0.312	21	41	8
24780-4011	59	24.803	26.378	0.787	630	670	20	24060-0212	61	0.984	1.378	0.276	25	35	7
24780-4026	59	28.543	30.512	0.984	725	775	25	24060-0213	61	0.875	1.375	0.312	22	35	8
24780-4321	59	7.283	8.859	0.630	185	225	16	24060-0215	61	0.875	1.500	0.312	22	38	8
24780-4416	59	6.889	8.071	0.591	175	205	15	24060-0221	61	0.875	1.750	0.375	22	44	10
24780-7267	59	5.512	6.693	0.591	140	170	15	24060-0287	61	1.000	1.500	0.312	25	38	8
24780-7268	59	6.693	7.875	0.591	170	200	15	24060-0288	61	1.000	1.500	0.375	25	38	10
24780-8655	59	10.630	12.205	0.630	270	310	16	24060-0290	61	1.000	1.575	0.375	25	40	10
24781-3678	59	24.409	26.378	0.866	620	670	22	24060-0292	61	1.000	1.625	0.375	25	41	10

All dimensions are in inches. Preferred sizes are indicated with **bold** type face.  
 Sizes listed are for standard nitrile elements, except Models 25 and 62 which have PTFE elements. Other material available on inquiry only.



## Oil Seals by Model Number

Product Code	Model	Inches			MM			Product Code	Model	Inches			MM		
		ID	OD	Width	ID	OD	Width			ID	OD	Width	ID	OD	Width
24060-0293	61	1.000	1.750	0.375	25	44	10	24060-1042	61	1.875	2.625	0.375	48	67	10
24060-0297	61	1.000	1.875	0.375	25	48	10	24060-1048	61	1.875	2.750	0.375	48	70	10
24060-0312	61	1.182	1.575	0.276	30	40	7	24060-1057	61	1.875	2.875	0.375	48	73	10
24060-0320	61	1.181	1.850	0.276	30	47	7	24060-1059	61	1.875	2.875	0.500	48	73	13
24060-0351	61	1.125	1.625	0.312	29	41	8	24060-1063	61	1.875	3.000	0.375	48	76	10
24060-0352	61	1.125	1.625	0.375	29	41	10	24060-1076	61	1.875	3.189	0.438	48	81	11
24060-0353	61	1.125	1.750	0.375	29	44	10	24060-1092	61	1.625	2.250	0.375	41	57	10
24060-0357	61	1.125	1.875	0.375	29	48	10	24060-1117	61	1.936	2.686	0.375	49	68	10
24060-0359	61	1.125	2.000	0.375	29	51	10	24060-1120	61	1.938	2.750	0.375	49	70	10
24060-0366	61	1.378	1.850	0.276	35	47	7	24060-1129	61	1.938	2.875	0.375	49	73	10
24060-0371	61	1.378	2.165	0.315	35	55	8	24060-1153	61	1.969	2.750	0.375	50	70	10
24060-0427	61	1.250	2.000	0.375	32	51	10	24060-1156	61	1.969	2.756	0.394	50	70	10
24060-0436	61	1.250	2.125	0.375	32	54	10	24060-1186	61	2.000	2.686	0.375	51	68	10
24060-0439	61	1.250	2.250	0.375	32	57	10	24060-1189	61	2.000	2.750	0.375	51	70	10
24060-0441	61	1.250	2.250	0.500	32	57	13	24060-1190	61	2.000	2.750	0.437	51	70	11
24060-0451	61	1.281	2.000	0.375	33	51	10	24060-1198	61	2.000	2.875	0.375	51	73	10
24060-0484	61	1.312	2.062	0.375	33	52	10	24060-1204	61	2.000	3.000	0.375	51	76	10
24060-0493	61	1.312	2.250	0.375	33	57	10	24060-1205	61	2.000	3.000	0.437	51	76	11
24060-0525	61	1.344	2.437	0.500	34	62	13	24060-1232	61	0.866	1.378	0.276	22	35	7
24060-0534	61	1.890	2.559	0.394	48	65	10	24060-1247	61	0.750	1.750	0.312	19	44	8
24060-0535	61	1.375	2.062	0.375	35	52	10	24060-1271	61	0.875	1.875	0.312	22	48	8
24060-0544	61	1.375	2.250	0.375	35	57	10	24060-1272	61	1.000	2.000	0.312	25	51	8
24060-0556	61	1.375	2.500	0.375	35	64	10	24060-1319	61	1.188	1.750	0.312	30	44	8
24060-0571	61	1.969	2.835	0.315	50	72	8	24060-1320	61	2.125	2.875	0.438	54	73	11
24060-0574	61	2.165	2.756	0.315	55	70	8	24060-1321	61	2.125	2.875	0.375	54	73	10
24060-0575	61	2.165	2.953	0.394	55	75	10	24060-1333	61	2.125	3.125	0.375	54	79	10
24060-0592	61	1.438	2.125	0.375	37	54	10	24060-1334	61	2.125	3.125	0.437	54	79	11
24060-0595	61	1.438	2.250	0.375	37	57	10	24060-1337	61	1.250	1.875	0.312	32	48	8
24060-0598	61	1.438	2.375	0.375	37	60	10	24060-1344	61	1.250	2.250	0.312	32	57	8
24060-0643	61	1.500	2.250	0.375	38	57	10	24060-1354	61	1.375	2.000	0.312	35	51	8
24060-0646	61	1.500	2.375	0.375	38	60	10	24060-1361	61	1.438	2.063	0.312	37	52	8
24060-0653	61	2.360	3.150	0.315	60	80	8	24060-1362	61	1.438	2.188	0.375	37	56	10
24060-0655	61	1.500	2.500	0.375	38	64	10	24060-1364	61	1.500	2.125	0.313	38	54	8
24060-0664	61	1.500	2.750	0.375	38	70	10	24060-1371	61	1.625	2.250	0.313	41	57	8
24060-0710	61	2.559	3.347	0.394	65	85	10	24060-1378	61	2.156	3.189	0.375	55	81	10
24060-0712	61	1.563	2.500	0.375	40	64	10	24060-1386	61	1.750	2.438	0.312	44	62	8
24060-0729	61	2.559	3.543	0.394	65	90	10	24060-1399	61	2.188	2.875	0.375	56	73	10
24060-0758	61	1.625	2.187	0.375	41	56	10	24060-1412	61	1.875	2.500	0.312	48	64	8
24060-0760	61	1.625	2.375	0.375	41	60	10	24060-1418	61	1.875	2.500	0.375	48	64	10
24060-0797	61	2.953	3.740	0.394	75	95	10	24060-1419	61	1.875	2.500	0.500	48	64	13
24060-0809	61	2.953	3.937	0.394	75	100	10	24060-1421	61	2.000	2.500	0.375	51	64	10
24060-0811	61	3.937	4.921	0.394	100	125	10	24060-1431	61	2.000	2.750	0.312	51	70	8
24060-0813	61	1.750	2.375	0.375	44	60	10	24060-1440	61	3.437	4.500	0.437	87	114	11
24060-0829	61	1.688	2.437	0.375	43	62	10	24060-1466	61	2.063	2.875	0.375	52	73	10
24060-0831	61	3.150	4.331	0.394	80	110	10	24060-1467	61	2.125	2.750	0.312	54	70	8
24060-0835	61	1.687	2.500	0.375	43	64	10	24060-1470	61	0.866	1.575	0.315	22	40	8
24060-0853	61	1.688	2.875	0.375	43	73	10	24060-1474	61	2.250	3.000	0.375	57	76	10
24060-0879	61	3.543	4.331	0.472	90	110	12	24060-1475	61	2.250	3.000	0.437	57	76	11
24060-0882	61	2.165	2.835	0.315	55	72	8	24060-1478	61	0.985	1.378	0.315	25	35	8
24060-0898	61	1.750	2.437	0.375	44	62	10	24060-1484	61	1.575	2.166	0.394	40	55	10
24060-0904	61	1.750	2.500	0.375	44	64	10	24060-1488	61	4.000	4.750	0.500	102	121	13
24060-0907	61	1.750	2.625	0.375	44	67	10	24060-1490	61	2.362	2.953	0.315	60	75	8
24060-0913	61	1.750	2.750	0.375	44	70	10	24060-1493	61	2.250	3.250	0.437	57	83	11
24060-0924	61	1.750	2.875	0.500	44	73	13	24060-1502	61	4.331	5.512	0.512	110	140	13
24060-0928	61	1.750	3.000	0.375	44	76	10	24060-1503	61	2.250	2.875	0.312	57	73	8
24060-1033	61	3.150	3.937	0.394	80	100	10	24060-1507	61	2.250	2.875	0.375	57	73	10

All dimensions are in inches. Preferred sizes are indicated with **bold** type face.

Sizes listed are for standard nitrile elements, except Models 25 and 62 which have PTFE elements. Other material available on inquiry only.

## Oil Seals by Model Number

Product Code	Model	Inches			MM			Product Code	Model	Inches			MM		
		ID	OD	Width	ID	OD	Width			ID	OD	Width	ID	OD	Width
24060-1509	61	2.250	3.375	0.437	57	86	11	24060-1856	61	3.543	4.331	0.394	90	110	10
24060-1514	61	2.375	3.000	0.312	60	76	8	24060-1859	61	3.740	4.724	0.394	95	120	10
24060-1523	61	2.375	3.000	0.438	60	76	11	24060-1880	61	4.725	5.906	0.512	120	150	13
24060-1529	61	2.375	3.375	0.437	60	86	11	24060-1884	61	5.315	6.496	0.315	135	165	8
24060-1539	61	2.438	3.500	0.438	62	89	11	24060-1898	61	5.512	6.496	0.394	140	165	10
24060-1541	61	2.500	3.125	0.312	64	79	8	24060-1912	61	1.575	2.362	0.394	40	60	10
24060-1544	61	2.500	3.375	0.437	64	86	11	24060-1931	61	1.575	2.165	0.394	40	55	10
24060-1547	61	2.500	4.500	0.437	64	114	11	24060-1966	61	5.000	5.750	0.500	127	146	13
24060-1549	61	2.625	3.250	0.312	67	83	8	24060-2003	61	2.688	3.751	0.438	68	95	11
24060-1553	61	2.750	3.375	0.312	70	86	8	24060-2035	61	2.750	3.500	0.375	70	89	10
24060-1560	61	2.875	4.000	0.500	73	102	13	24060-2037	61	2.750	3.500	0.500	70	89	13
24060-1569	61	3.125	4.000	0.375	79	102	10	24060-2038	61	2.756	3.543	0.394	70	90	10
24060-1572	61	3.250	3.875	0.312	83	98	8	24060-2059	61	2.880	3.625	0.375	73	92	10
24060-1574	61	3.250	4.000	0.437	83	102	11	24060-2073	61	2.125	2.625	0.375	54	67	10
24060-1580	61	3.375	4.000	0.312	86	102	8	24060-2074	61	4.187	4.999	0.468	106	127	12
24060-1599	61	3.500	4.250	0.500	89	108	13	24060-2082	61	1.969	3.250	0.437	50	83	11
24060-1604	61	3.563	4.500	0.500	91	114	13	24060-2118	61	2.875	3.751	0.375	73	95	10
24060-1624	61	2.344	3.500	0.375	60	89	10	24060-2119	61	1.417	1.969	0.276	36	50	7
24060-1642	61	2.375	3.125	0.375	60	79	10	24060-2123	61	2.875	3.875	0.500	73	98	13
24060-1652	61	4.250	5.125	0.500	108	130	13	24060-2140	61	2.937	3.937	0.500	75	100	13
24060-1655	61	2.375	3.250	0.437	60	83	11	24060-2146	61	2.938	3.750	0.375	75	95	10
24060-1676	61	5.375	6.125	0.500	137	156	13	24060-2148	61	2.937	3.751	0.500	75	95	13
24060-1679	61	5.500	6.250	0.437	140	159	11	24060-2153	61	2.938	4.003	0.438	75	102	11
24060-1682	61	5.500	6.375	0.500	140	162	13	24060-2168	61	3.000	3.750	0.375	76	95	10
24060-1683	61	5.500	6.500	0.250	140	165	6	24060-2169	61	3.000	3.750	0.438	76	95	11
24060-1685	61	5.750	6.500	0.500	146	165	13	24060-2170	61	3.000	3.750	0.500	76	95	13
24060-1687	61	6.500	7.500	0.250	165	191	6	24060-2212	61	1.260	2.047	0.354	32	52	9
24060-1724	61	7.125	8.000	0.375	181	203	10	24060-2218	61	1.142	1.575	0.250	29	40	6
24060-1731	61	7.125	8.500	0.500	181	216	13	24060-2224	61	1.260	1.772	0.315	32	45	8
24060-1747	61	2.438	3.500	0.375	62	89	10	24060-2231	61	3.125	4.375	0.500	79	111	13
24060-1748	61	0.315	0.709	0.197	8	18	5	24060-2239	61	2.500	3.000	0.375	64	76	10
24060-1754	61	0.670	1.103	0.315	17	28	8	24060-2241	61	0.984	1.500	0.375	25	38	10
24060-1755	61	0.669	1.378	0.315	17	35	8	24060-2266	61	2.570	3.250	0.375	65	83	10
24060-1760	61	0.787	1.378	0.315	20	35	8	24060-2276	61	3.250	4.500	0.500	83	114	13
24060-1761	61	0.984	1.653	0.315	25	42	8	24060-2280	61	0.630	1.182	0.315	16	30	8
24060-1763	61	1.182	1.653	0.315	30	42	8	24060-2282	61	3.250	4.750	0.500	83	121	13
24060-1776	61	1.260	1.850	0.315	32	47	8	24060-2296	61	5.625	6.875	0.219	143	175	6
24060-1784	61	1.300	1.772	0.315	33	45	8	24060-2316	61	5.625	6.875	0.281	143	175	7
24060-1787	61	1.378	1.850	0.315	35	47	8	24060-2324	61	3.375	4.500	0.500	86	114	13
24060-1789	61	1.378	1.969	0.394	35	50	10	24060-2334	61	1.188	1.750	0.375	30	44	10
24060-1792	61	1.496	2.362	0.394	38	60	10	24060-2335	61	1.438	1.938	0.375	37	49	10
24060-1793	61	1.653	2.441	0.394	42	62	10	24060-2345	61	3.438	4.500	0.500	87	114	13
24060-1794	61	1.496	2.125	0.394	38	54	10	24060-2348	61	3.437	4.625	0.500	87	117	13
24060-1796	61	1.772	2.363	0.315	45	60	8	24060-2366	61	3.500	4.500	0.500	89	114	13
24060-1797	61	1.772	2.441	0.394	45	62	10	24060-2404	61	7.125	8.375	0.500	181	213	13
24060-1807	61	2.500	3.250	0.375	64	83	10	24060-2410	61	1.500	2.375	0.312	38	60	8
24060-1808	61	2.500	3.250	0.437	64	83	11	24060-2411	61	3.150	4.134	0.394	80	105	10
24060-1814	61	1.969	2.559	0.394	50	65	10	24060-2420	61	3.625	4.750	0.500	92	121	13
24060-1820	61	2.500	3.500	0.437	64	89	11	24060-2422	61	1.969	2.953	0.315	50	75	8
24060-1835	61	2.166	2.835	0.394	55	72	10	24060-2451	61	2.675	3.350	0.375	68	85	10
24060-1839	61	2.362	3.150	0.394	60	80	10	24060-2460	61	1.399	2.292	0.315	36	58	8
24060-1842	61	2.625	3.625	0.437	67	92	11	24060-2461	61	5.512	7.087	0.591	140	180	15
24060-1847	61	2.559	3.150	0.394	65	80	10	24060-2462	61	3.750	4.750	0.500	95	121	13
24060-1848	61	2.953	3.740	0.512	75	95	13	24060-2465	61	3.750	4.875	0.500	95	124	13
24060-1853	61	3.346	4.134	0.394	85	105	10	24060-2478	61	1.938	2.500	0.375	49	64	10
24060-1854	61	3.346	4.331	0.394	85	110	10	24060-2503	61	1.000	2.047	0.312	25	52	8

All dimensions are in inches. Preferred sizes are indicated with **bold** type face. Sizes listed are for standard nitrile elements, except Models 25 and 62 which have PTFE elements. Other material available on inquiry only.

## Oil Seals by Model Number

Product Code	Model	Inches			MM			Product Code	Model	Inches			MM		
		ID	OD	Width	ID	OD	Width			ID	OD	Width	ID	OD	Width
24060-2508	61	2.874	3.543	0.393	73	90	10	24060-3892	61	2.000	3.375	0.500	51	86	13
24060-2514	61	1.922	2.875	0.438	49	73	11	24060-3919	61	2.165	3.145	0.315	55	80	8
24060-2526	61	2.813	3.751	0.438	71	95	11	24060-3976	61	1.378	2.559	0.315	35	65	8
24060-2532	61	1.693	2.756	0.315	43	70	8	24060-3978	61	1.496	3.150	0.315	38	80	8
24060-2540	61	4.000	5.125	0.500	102	130	13	24060-3986	61	3.345	4.250	0.500	85	108	13
24060-2562	61	3.320	4.132	0.450	84	105	11	24060-4087	61	3.960	4.875	0.375	101	124	10
24060-2574	61	1.552	2.500	0.500	39	64	13	24060-4091	61	4.595	6.000	0.500	117	152	13
24060-2584	61	2.362	4.331	0.438	60	110	11	24060-4429	61	0.472	0.875	0.276	12	22	7
24060-2587	61	0.750	1.312	0.250	19	33	6	24060-4298	61	2.212	3.250	0.375	56	83	10
24060-2589	61	2.000	2.750	0.250	51	70	6	24060-4362	61	2.441	3.150	0.315	62	80	8
24060-2603	61	4.125	5.250	0.500	105	133	13	24060-4423	61	2.000	3.250	0.375	51	83	10
24060-2638	61	3.375	5.000	0.468	86	127	12	24060-4474	61	2.559	3.740	0.437	65	95	11
24060-2657	61	4.250	5.250	0.500	108	133	13	24060-4478	61	6.938	8.375	0.625	176	213	16
24060-2715	61	1.102	1.575	0.394	28	40	10	24060-4485	61	1.000	2.052	0.250	25	52	6
24060-2732	61	4.437	5.500	0.500	113	140	13	24060-4555	61	1.375	2.445	0.313	35	62	8
24060-2756	61	4.500	5.250	0.500	114	133	13	24060-4557	61	3.000	4.000	0.500	76	102	13
24060-2763	61	4.500	5.250	0.375	114	133	10	24060-4582	61	2.000	2.625	0.312	51	67	8
24060-2784	61	1.260	2.126	0.394	32	54	10	24060-4622	61	0.375	0.875	0.196	10	22	5
24060-2797	61	2.250	2.875	0.438	57	73	11	24060-4651	61	4.000	5.000	0.500	102	127	13
24060-2803	61	1.181	2.047	0.394	30	52	10	24060-4798	61	1.500	2.125	0.375	38	54	10
24060-2814	61	2.756	3.543	0.472	70	90	12	24060-4804	61	3.000	4.250	0.500	76	108	13
24060-2837	61	4.750	5.750	0.500	121	146	13	24060-4873	61	4.500	5.500	0.437	114	140	11
24060-2843	61	4.750	6.000	0.500	121	152	13	24060-4892	61	2.125	2.750	0.375	54	70	10
24060-2902	61	1.969	2.835	0.394	50	72	10	24060-5023	61	3.000	4.000	0.375	76	102	10
24060-2915	61	5.000	6.000	0.500	127	152	13	24060-5079	61	3.750	5.000	0.500	95	127	13
24060-2920	61	2.687	3.375	0.375	68	86	10	24060-5239	61	1.250	1.750	0.250	32	44	6
24060-2921	61	5.000	6.250	0.500	127	159	13	24060-5306	61	1.000	1.500	0.250	25	38	6
24060-2963	61	4.375	5.000	0.375	111	127	10	24060-5407	61	2.625	3.375	0.375	67	86	10
24060-2966	61	2.953	3.937	0.375	75	100	10	24060-5562	61	1.103	1.850	0.394	28	47	10
24060-2978	61	1.299	1.969	0.394	33	50	10	24060-5704	61	1.250	1.875	0.375	32	48	10
24060-2995	61	2.500	3.125	0.375	64	79	10	24060-5872	61	3.938	4.875	0.500	100	124	13
24060-3004	61	1.654	2.362	0.394	42	60	10	24060-6077	61	0.500	1.125	0.250	13	29	6
24060-3019	61	1.770	2.627	0.312	45	67	8	24060-6285	61	3.500	4.375	0.500	89	111	13
24060-3055	61	5.500	6.125	0.500	140	156	13	24060-6300	61	2.559	3.937	0.394	65	100	10
24060-3065	61	5.250	6.500	0.500	133	165	13	24060-6363	61	4.500	5.500	0.375	114	140	10
24060-3122	61	5.375	6.375	0.500	137	162	13	24060-6374	61	7.000	8.000	0.500	178	203	13
24060-3275	61	5.750	6.750	0.500	146	171	13	24060-6377	61	7.250	8.500	0.500	184	216	13
24060-3339	61	4.720	5.748	0.500	120	146	13	24060-6656	61	1.969	2.835	0.375	50	72	10
24060-3347	61	5.938	7.500	0.500	151	191	13	24060-6859	61	0.984	1.850	0.394	25	47	10
24060-3367	61	6.000	7.500	0.500	152	191	13	24060-7016	61	0.500	1.250	0.250	13	32	6
24060-3370	61	6.000	7.500	0.750	152	191	19	24060-7164	61	1.875	2.835	0.375	48	72	10
24060-3386	61	4.063	5.250	0.375	103	133	10	24060-7249	61	3.750	5.375	0.500	95	137	13
24060-3414	61	2.250	4.003	0.468	57	102	12	24060-7374	61	3.250	4.250	0.500	83	108	13
24060-3449	61	1.772	4.000	0.394	45	102	10	24060-7383	61	5.512	6.693	0.552	140	170	14
24060-3457	61	0.313	0.687	0.188	8	17	5	24060-7386	61	1.375	2.000	0.375	35	51	10
24060-3479	61	2.125	4.125	0.500	54	105	13	24060-7388	61	7.874	9.055	0.591	200	230	15
24060-3583	61	1.750	2.716	0.313	44	69	8	24060-7396	61	4.331	5.512	0.472	110	140	12
24060-3600	61	8.000	9.500	0.625	203	241	16	24060-7415	61	1.969	3.150	0.375	50	80	10
24060-3606	61	8.250	9.500	0.625	210	241	16	24060-7596	61	2.937	3.937	0.375	75	100	10
24060-3619	61	9.000	10.500	0.750	229	267	19	24060-7727	61	0.188	0.750	0.250	5	19	6
24060-3657	61	4.480	5.500	0.500	114	140	13	24060-7807	61	7.087	8.268	0.591	180	210	15
24060-3660	61	10.000	11.000	0.562	254	279	14	24060-7839	61	3.543	4.724	0.472	90	120	12
24060-3775	61	3.976	5.512	0.512	101	140	13	24060-7884	61	1.575	2.441	0.394	40	62	10
24060-3829	61	0.984	1.575	0.276	25	40	7	24060-7979	61	3.937	5.119	0.512	100	130	13
24060-3853	61	12.000	14.000	0.625	305	356	16	24060-8020	61	0.591	1.182	0.315	15	30	8
24060-3863	61	0.250	0.750	0.250	6	19	6	24060-8049	61	7.480	8.661	0.591	190	220	15

All dimensions are in inches. Preferred sizes are indicated with **bold** type face.

Sizes listed are for standard nitrile elements, except Models 25 and 62 which have PTFE elements. Other material available on inquiry only.

## Oil Seals by Model Number

Product Code	Model	Inches			MM			Product Code	Model	Inches			MM		
		ID	OD	Width	ID	OD	Width			ID	OD	Width	ID	OD	Width
24060-8344	61	0.750	1.378	0.312	19	35	8	24062-3047	61	1.250	1.875	0.625	32	48	16
24060-8373	61	2.441	3.150	0.394	62	80	10	24062-3166	61	1.969	2.835	0.472	50	72	12
24060-8610	61	1.575	2.441	0.375	40	62	10	24062-3211	61	1.772	2.750	0.438	45	70	11
24060-8887	61	1.250	1.750	0.375	32	44	10	24062-3513	61	2.000	2.625	0.438	51	67	11
24060-9223	61	1.772	2.559	0.394	45	65	10	24062-3517	61	1.575	2.441	0.438	40	62	11
24060-9224	61	8.250	9.500	0.625	210	241	16	24062-3531	61	1.181	2.047	0.438	30	52	11
24060-9342	61	1.181	1.850	0.375	30	47	10	24062-3625	61	2.756	3.543	0.437	70	90	11
24060-9490	61	1.000	1.625	0.250	25	41	6	24062-3815	61	1.220	2.047	0.438	31	52	11
24060-9505	61	0.500	1.000	0.250	13	25	6	24062-3849	61	0.875	1.625	0.438	22	41	11
24060-9509	61	0.625	1.250	0.250	16	32	6	24062-3987	61	2.165	2.835	0.437	55	72	11
24060-9515	61	0.875	1.375	0.250	22	35	6	24062-4354	61	1.772	2.441	0.438	45	62	11
24060-9612	61	1.375	2.875	0.375	35	73	10	24062-4409	61	5.375	6.375	0.438	137	162	11
24060-9721	61	11.750	13.750	0.625	298	349	16	24062-4419	61	1.102	1.575	0.437	28	40	11
24060-9722	61	1.500	2.250	0.250	38	57	6	24062-4557	61	3.000	4.000	0.500	76	102	13
24060-9963	61	3.543	4.528	0.472	90	115	12	24062-4651	61	4.000	5.000	0.500	102	127	13
24062-0050	61	0.500	1.000	0.375	13	25	10	24062-4873	61	4.500	5.500	0.438	114	140	11
24062-0288	61	1.000	1.500	0.375	25	38	10	24062-4875	61	2.756	4.331	0.512	70	110	13
24062-0292	61	1.000	1.625	0.375	25	41	10	24062-4958	61	2.312	3.250	0.687	59	83	17
24062-0357	61	1.125	1.875	0.375	29	48	10	24062-5913	61	3.938	5.000	0.500	100	127	13
24062-0645	61	1.500	2.250	0.500	38	57	13	24062-7396	61	4.331	5.512	0.472	110	140	12
24062-0837	61	1.688	2.500	0.500	43	64	13	24062-9223	61	1.772	2.559	0.394	45	65	10
24062-0905	61	1.750	2.500	0.437	44	64	11	24063-0092	61	0.625	1.375	0.375	16	35	10
24062-1043	61	1.875	2.625	0.438	48	67	11	24063-0288	61	1.000	1.500	0.375	25	38	10
24062-1191	61	2.000	2.750	0.500	51	70	13	24063-0645	61	1.500	2.250	0.500	38	57	13
24062-1200	61	2.000	2.875	0.500	51	73	13	24063-1114	61	1.938	2.625	0.375	49	67	10
24062-1205	61	2.000	3.000	0.438	51	76	11	24063-1190	61	2.000	2.750	0.438	51	70	11
24062-1307	61	1.125	1.625	0.438	29	41	11	24063-1191	61	2.000	2.750	0.500	51	70	13
24062-1346	61	2.125	3.250	0.438	54	83	11	24063-1856	61	3.543	4.331	0.394	90	110	10
24062-1377	61	1.750	2.375	0.500	44	60	13	24063-2037	61	2.750	3.500	0.500	70	89	13
24062-1419	61	1.875	2.500	0.500	48	64	13	24063-2055	61	1.575	2.165	0.315	40	55	8
24062-1446	61	2.000	3.250	0.437	51	83	11	24063-2169	61	3.000	3.750	0.438	76	95	11
24062-1476	61	2.250	3.000	0.500	57	76	13	24063-2170	61	3.000	3.751	0.500	76	95	13
24062-1493	61	2.250	3.250	0.438	57	83	11	24063-2235	61	3.750	4.500	0.375	95	114	10
24062-1494	61	2.250	3.250	0.500	57	83	13	24063-2239	61	2.500	3.000	0.375	64	76	10
24062-1502	61	4.331	5.512	0.512	110	140	13	24063-2242	61	3.937	4.724	0.472	100	120	12
24062-1563	61	2.312	3.125	0.500	59	79	13	24063-2281	61	6.100	6.875	0.625	155	175	16
24062-1789	61	1.378	1.969	0.394	35	50	10	24063-2336	61	3.375	4.999	0.500	86	127	13
24062-1820	61	2.500	3.500	0.438	64	89	11	24063-2403	61	4.188	4.999	0.438	106	127	11
24062-1856	61	3.543	4.331	0.394	90	110	10	24063-2725	61	0.625	1.625	0.438	16	41	11
24062-2046	61	2.750	3.751	0.500	70	95	13	24063-2797	61	2.250	2.875	0.438	57	73	11
24062-2169	61	3.000	3.750	0.438	76	95	11	24063-2811	61	4.921	5.906	0.500	125	150	13
24062-2170	61	3.000	3.750	0.500	76	95	13	24063-2814	61	2.756	3.543	0.472	70	90	12
24062-2239	61	2.500	3.000	0.375	64	76	10	24063-2821	61	1.938	2.750	0.438	49	70	11
24062-2242	61	3.937	4.724	0.472	100	120	12	24063-2838	61	4.750	5.750	0.562	121	146	14
24062-2280	61	0.630	1.182	0.315	16	30	8	24063-2991	61	1.458	2.125	0.438	37	54	11
24062-2318	61	3.250	3.875	0.375	83	98	10	24063-3033	61	2.960	3.750	0.438	75	95	11
24062-2366	61	3.500	4.500	0.500	89	114	13	24063-3127	61	5.375	6.500	0.625	137	165	16
24062-2377	61	2.953	3.543	0.393	75	90	10	24063-3153	61	1.750	2.375	0.437	44	60	11
24062-2410	61	1.500	2.375	0.438	38	60	11	24063-3267	61	1.181	1.575	0.438	30	40	11
24062-2708	61	4.375	5.375	0.500	111	137	13	24063-3274	61	1.710	2.375	0.438	43	60	11
24062-2800	61	6.625	7.500	0.500	168	191	13	24063-3591	61	1.575	2.362	0.438	40	60	11
24062-2821	61	1.938	2.750	0.438	49	70	11	24063-3625	61	2.756	3.543	0.437	70	90	11
24062-2831	61	4.688	6.250	0.500	119	159	13	24063-3923	61	2.212	3.250	0.437	56	83	11
24062-2915	61	5.000	6.000	0.500	127	152	13	24063-3956	61	2.058	2.750	0.438	52	70	11
24062-2991	61	1.458	2.125	0.438	37	54	11	24063-4278	61	1.625	2.250	0.438	41	57	11
24062-3031	61	1.250	1.875	0.438	32	48	11	24063-4355	61	2.559	3.346	0.437	65	85	11

All dimensions are in inches. Preferred sizes are indicated with **bold** type face. Sizes listed are for standard nitrile elements, except Models 25 and 62 which have PTFE elements. Other material available on inquiry only.

## Oil Seals by Model Number

Product Code	Model	Inches			MM			Product Code	Model	Inches			MM		
		ID	OD	Width	ID	OD	Width			ID	OD	Width	ID	OD	Width
24063-4474	61	2.559	3.740	0.437	65	95	11	24075-6169	61	1.125	1.625	0.250	29	41	6
24063-4557	61	3.000	4.000	0.500	76	102	13	24076-0088	61	0.625	1.125	0.375	16	29	10
24063-4574	61	2.756	3.937	0.437	70	100	11	24076-3267	61	1.181	1.575	0.438	30	40	11
24063-4651	61	4.000	5.000	0.500	102	127	13	24076-6523	61	0.875	1.375	0.438	22	35	11
24063-5306	61	1.000	1.500	0.437	25	38	11	24076-9662	61	4.000	5.000	0.437	102	127	11
24063-6612	61	0.750	1.250	0.438	19	32	11	24077-0015	61	0.375	0.875	0.250	10	22	6
24063-6755	61	1.000	1.500	0.438	25	38	11	24077-0147	61	0.750	1.625	0.312	19	41	8
24064-0070	61	0.563	1.250	0.375	14	32	10	24077-0117	61	1.936	2.686	0.375	49	68	10
24064-0292	61	1.000	1.625	0.375	25	41	10	24077-1186	61	2.000	2.686	0.375	51	68	10
24064-0427	61	1.250	2.000	0.375	32	51	10	24077-1198	61	2.000	2.875	0.375	51	73	10
24064-0882	61	2.165	2.835	0.315	55	72	8	24077-2242	61	3.937	4.724	0.472	100	120	12
24064-1033	61	3.150	3.937	0.394	80	100	10	24077-3187	61	1.084	1.625	0.313	28	41	8
24064-1470	61	0.867	1.575	0.315	22	40	8	24078-1043	61	1.875	2.625	0.438	48	67	11
24064-1494	61	2.250	3.250	0.500	57	83	13	24078-1737	61	2.438	3.250	0.500	62	83	13
24064-1502	61	4.331	5.512	0.512	110	140	13	24102-3422	61	3.938	4.875	0.040	100	124	1
24064-1605	61	3.625	4.250	0.312	92	108	8	24102-4337	61	9.843	10.630	0.039	250	270	1
24064-1788	61	1.378	1.850	0.394	35	47	10	24106-5562	61	1.103	1.851	0.394	28	47	10
24064-1799	61	1.772	2.559	0.315	45	65	8	24107-4651	61	4.000	5.000	0.500	102	127	13
24064-1814	61	1.969	2.559	0.394	50	65	10	24110-0091	61	0.625	1.375	0.312	16	35	8
24064-1820	61	2.500	3.500	0.438	64	89	11	24110-0148	61	0.750	1.625	0.375	19	41	10
24064-1839	61	2.362	3.150	0.394	60	80	10	24110-0149	61	0.750	1.750	0.375	19	44	10
24064-1854	61	3.347	4.331	0.394	85	110	10	24110-0215	61	0.875	1.500	0.312	22	38	8
24064-1856	61	3.543	4.331	0.394	90	110	10	24110-0293	61	1.000	1.750	0.375	25	44	10
24064-1880	61	4.725	5.906	0.512	120	150	13	24110-0427	61	1.250	2.000	0.375	32	51	10
24064-1912	61	1.575	2.362	0.394	40	60	10	24110-6077	61	0.500	1.125	0.250	13	29	6
24064-1931	61	1.575	2.166	0.394	40	55	10	24116-0015	61	0.375	0.875	0.250	10	22	6
24064-2366	61	3.500	4.500	0.500	89	114	13	24124-0013	61	0.375	0.750	0.250	10	19	6
24064-2837	61	4.750	5.750	0.500	121	146	13	24125-0013	61	0.375	0.750	0.250	10	19	6
24064-2843	61	4.750	6.000	0.500	121	152	13	24125-0292	61	1.000	1.625	0.375	25	41	10
24064-3176	61	5.500	6.500	0.500	140	165	13	24125-0351	61	1.125	1.625	0.313	29	41	8
24064-4001	61	13.750	15.250	0.625	349	387	16	24125-0352	61	1.125	1.625	0.375	29	41	10
24064-4557	61	3.000	4.000	0.500	76	102	13	24125-0648	61	1.500	2.375	0.500	38	60	13
24064-4717	61	1.575	2.165	0.315	40	55	8	24125-0710	61	2.559	3.346	0.394	65	85	10
24064-5562	61	1.103	1.851	0.394	28	47	10	24125-0735	61	2.677	3.543	0.394	68	90	10
24064-6374	61	7.000	8.000	0.500	178	203	13	24125-0759	61	2.756	3.937	0.394	70	100	10
24064-6383	61	8.500	9.500	0.500	216	241	13	24125-1427	61	2.000	2.625	0.375	51	67	10
24064-7386	61	1.375	2.000	0.375	35	51	10	24125-1553	61	2.750	3.375	0.312	70	86	8
24064-7388	61	7.874	9.055	0.591	200	230	15	24125-1760	61	0.787	1.378	0.315	20	35	8
24064-7396	61	4.331	5.512	0.472	110	140	12	24125-1761	61	0.984	1.653	0.315	25	42	8
24064-7807	61	7.087	8.268	0.591	180	210	15	24125-1787	61	1.378	1.850	0.315	35	47	8
24064-8373	61	2.441	3.150	0.394	62	80	10	24125-1789	61	1.378	1.969	0.394	35	50	10
24064-8887	61	1.250	1.750	0.375	32	44	10	24125-1793	61	1.654	2.441	0.394	42	62	10
24064-9342	61	1.181	1.850	0.375	30	47	10	24125-1814	61	1.969	2.559	0.394	50	65	10
24067-0215	61	0.875	1.500	0.313	22	38	8	24125-1856	61	3.543	4.331	0.394	90	110	10
24067-0813	61	1.750	2.375	0.375	44	60	10	24125-1859	61	3.740	4.724	0.394	95	120	10
24067-1092	61	1.625	2.250	0.375	41	57	10	24125-2146	61	2.938	3.750	0.375	75	95	10
24067-1475	61	2.250	3.000	0.437	57	76	11	24125-2149	61	2.938	3.875	0.375	75	98	10
24067-2753	61	4.500	5.500	0.500	114	140	13	24125-2602	61	1.969	3.150	0.394	50	80	10
24067-2915	61	5.000	6.000	0.500	127	152	13	24125-3004	61	1.654	2.362	0.394	42	60	10
24069-1033	61	3.150	3.937	0.394	80	100	10	24125-3267	61	1.181	1.575	0.438	30	40	11
24069-1156	61	1.969	2.756	0.375	50	70	10	24125-4737	61	2.500	4.750	0.375	64	121	10
24071-0013	61	0.375	0.750	0.250	10	19	6	24125-4798	61	1.500	2.125	0.375	38	54	10
24071-3863	61	0.250	0.750	0.250	6	19	6	24125-8887	61	1.250	1.750	0.375	32	44	10
24075-1431	61	2.000	2.750	0.312	51	70	8	24125-9342	61	1.181	1.850	0.375	30	47	10
24075-3016	61	1.938	2.750	0.312	49	70	8	24125-9822	61	1.750	2.375	0.312	44	60	8
24075-3018	61	1.625	2.125	0.312	41	54	8	24126-1939	61	2.625	3.500	0.375	67	89	10

All dimensions are in inches. Preferred sizes are indicated with **bold** type face.

Sizes listed are for standard nitrile elements, except Models 25 and 62 which have PTFE elements. Other material available on inquiry only.

## Oil Seals by Model Number

Product Code	Model	Inches			MM			Product Code	Model	Inches			MM		
		ID	OD	Width	ID	OD	Width			ID	OD	Width	ID	OD	Width
24126-2042	61	2.750	3.623	0.438	70	92	11	21702-0425	62	1.250	1.984	0.438	32	50	11
24126-2366	61	3.500	4.500	0.500	89	114	13	21702-0427	62	1.250	2.000	0.375	32	51	10
24128-0656	61	1.500	2.500	0.438	38	64	11	21702-0439	62	1.250	2.250	0.375	32	57	10
24128-1307	61	1.125	1.625	0.438	29	41	11	21702-0442	62	1.250	2.375	0.375	32	60	10
24128-1403	61	2.188	3.000	0.438	56	76	11	21702-0445	62	1.250	2.437	0.375	32	62	10
24128-1793	61	1.654	2.441	0.394	42	62	10	21702-0496	62	1.313	2.375	0.375	33	60	10
24128-1856	61	3.543	4.331	0.394	90	110	10	21702-0517	62	1.344	2.250	0.375	34	57	10
24128-2611	61	5.000	6.000	0.469	127	152	12	21702-0535	62	1.375	2.062	0.375	35	52	10
24128-2815	61	2.313	3.000	0.438	59	76	11	21702-0541	62	1.375	2.125	0.375	35	54	10
24128-3021	61	1.811	2.835	0.394	46	72	10	21702-0543	62	1.375	2.125	0.500	35	54	13
24128-3041	61	0.787	1.378	0.472	20	35	12	21702-0544	62	1.375	2.250	0.375	35	57	10
24128-3054	61	2.165	2.756	0.472	55	70	12	21702-0548	62	1.375	2.375	0.438	35	60	11
24128-6755	61	1.000	1.500	0.438	25	38	11	21702-0552	62	1.375	2.437	0.500	35	62	13
24128-9915	61	3.000	4.000	0.438	76	102	11	21702-0565	62	1.406	2.125	0.375	36	54	10
21428-0351	62	1.125	1.625	0.313	29	41	8	21702-0597	62	1.437	2.250	0.500	36	57	13
21428-0769	62	1.625	2.500	0.375	41	64	10	21702-0598	62	1.437	2.375	0.375	36	60	10
21428-0840	62	1.687	2.625	0.500	43	67	13	21702-0600	62	1.438	2.375	0.500	37	60	13
21702-0025	62	0.406	0.875	0.312	10	22	8	21702-0643	62	1.500	2.250	0.375	38	57	10
21702-0037	62	0.438	1.000	0.313	11	25	8	21702-0645	62	1.500	2.250	0.500	38	57	13
21702-0049	62	0.500	1.000	0.313	13	25	8	21702-0646	62	1.500	2.375	0.375	38	60	10
21702-0050	62	0.500	1.000	0.375	13	25	10	21702-0655	62	1.500	2.500	0.375	38	64	10
21702-0051	62	0.500	1.125	0.313	13	29	8	21702-0657	62	1.500	2.500	0.500	38	64	13
21702-0052	62	0.500	1.125	0.375	13	29	10	21702-0670	62	1.531	2.250	0.375	39	57	10
21702-0087	62	0.625	1.125	0.313	16	29	8	21702-0700	62	1.563	2.250	0.375	40	57	10
21702-0091	62	0.625	1.375	0.313	16	35	8	21702-0703	62	1.563	2.375	0.375	40	60	10
21702-0096	62	0.625	1.575	0.375	16	40	10	21702-0705	62	1.563	2.375	0.500	40	60	13
21702-0097	62	0.656	1.125	0.313	17	29	8	21702-0706	62	1.563	2.437	0.375	40	62	10
21702-0110	62	0.688	1.125	0.375	17	29	10	21702-0712	62	1.563	2.500	0.375	40	64	10
21702-0111	62	0.688	1.250	0.313	17	32	8	21702-0730	62	1.594	2.375	0.375	40	60	10
21702-0139	62	0.750	1.250	0.313	19	32	8	21702-0752	62	5.750	7.125	0.563	146	181	14
21702-0141	62	0.750	1.375	0.313	19	35	8	21702-0760	62	1.625	2.375	0.375	41	60	10
21702-0143	62	0.750	1.500	0.313	19	38	8	21702-0772	62	1.625	2.625	0.375	41	67	10
21702-0144	62	0.750	1.500	0.375	19	38	10	21702-0774	62	1.625	2.625	0.500	41	67	13
21702-0147	62	0.750	1.625	0.313	19	41	8	21702-0826	62	1.688	2.375	0.375	43	60	10
21702-0157	62	0.781	1.250	0.313	20	32	8	21702-0829	62	1.688	2.437	0.375	43	62	10
21702-0159	62	0.781	1.375	0.313	20	35	8	21702-0835	62	1.688	2.500	0.375	43	64	10
21702-0213	62	0.875	1.375	0.313	22	35	8	21702-0843	62	1.688	2.686	0.500	43	68	13
21702-0215	62	0.875	1.500	0.313	22	38	8	21702-0874	62	1.719	2.686	0.375	44	68	10
21702-0216	62	0.875	1.500	0.375	22	38	10	21702-0898	62	1.750	2.437	0.375	44	62	10
21702-0224	62	0.875	1.828	0.438	22	46	11	21702-0901	62	1.750	2.497	0.375	44	63	10
21702-0251	62	0.938	1.500	0.313	24	38	8	21702-0904	62	1.750	2.500	0.375	44	64	10
21702-0283	62	0.969	2.000	0.375	25	51	10	21702-0913	62	1.750	2.750	0.375	44	70	10
21702-0287	62	1.000	1.500	0.313	25	38	8	21702-0915	62	1.750	2.750	0.500	44	70	13
21702-0288	62	1.000	1.500	0.375	25	38	10	21702-0928	62	1.750	3.000	0.375	44	76	10
21702-0291	62	1.000	1.625	0.313	25	41	8	21702-1042	62	1.875	2.625	0.375	48	67	10
21702-0293	62	1.000	1.750	0.375	25	44	10	21702-1046	62	1.875	2.686	0.437	48	68	11
21702-0297	62	1.000	1.875	0.375	25	48	10	21702-1048	62	1.875	2.750	0.375	48	70	10
21702-0301	62	1.000	2.000	0.375	25	51	10	21702-1114	62	1.938	2.625	0.375	49	67	10
21702-0325	62	1.062	1.750	0.375	27	44	10	21702-1117	62	1.937	2.686	0.375	49	68	10
21702-0351	62	1.125	1.625	0.313	29	41	8	21702-1135	62	1.938	3.000	0.375	49	76	10
21702-0353	62	1.125	1.750	0.375	29	44	10	21702-1150	62	1.969	2.686	0.375	50	68	10
21702-0357	62	1.125	1.875	0.375	29	48	10	21702-1155	62	1.962	3.188	0.469	50	81	12
21702-0359	62	1.125	2.000	0.375	29	51	10	21702-1168	62	1.969	3.000	0.375	50	76	10
21702-0385	62	1.188	1.984	0.375	30	50	10	21702-1186	62	2.000	2.686	0.375	51	68	10
21702-0390	62	1.188	2.062	0.438	30	52	11	21702-1189	62	2.000	2.750	0.375	51	70	10
21702-0424	62	1.250	1.984	0.375	32	50	10	21702-1191	62	2.000	2.750	0.500	51	70	13

All dimensions are in inches. Preferred sizes are indicated with **bold** type face.  
 Sizes listed are for standard nitrile elements, except Models 25 and 62 which have PTFE elements. Other material available on inquiry only.

## Oil Seals by Model Number

Product Code	Model	Inches			MM			Product Code	Model	Inches			MM		
		ID	OD	Width	ID	OD	Width			ID	OD	Width	ID	OD	Width
21702-1204	62	2.000	3.000	0.375	51	76	10	21702-2273	62	3.250	4.375	0.500	83	111	13
21702-1206	62	2.000	3.000	0.500	51	76	13	21702-2297	62	3.313	4.375	0.500	84	111	13
21702-1252	62	2.062	2.875	0.375	52	73	10	21702-2321	62	3.375	4.375	0.500	86	111	13
21702-1321	62	2.125	2.875	0.375	54	73	10	21702-2327	62	3.375	4.625	0.500	86	117	13
21702-1329	62	2.125	3.000	0.500	54	76	13	21702-2336	62	3.375	5.000	0.500	86	127	13
21702-1333	62	2.125	3.125	0.375	54	79	10	21702-2345	62	3.438	4.500	0.500	87	114	13
21702-1366	62	2.156	3.000	0.375	55	76	10	21702-2348	62	3.437	4.625	0.500	87	117	13
21702-1404	62	2.188	3.000	0.500	56	76	13	21702-2366	62	3.500	4.500	0.500	89	114	13
21702-1408	62	2.188	3.125	0.375	56	79	10	21702-2367	62	3.500	4.500	0.563	89	114	14
21702-1471	62	2.250	2.997	0.375	57	76	10	21702-2372	62	3.500	4.750	0.500	89	121	13
21702-1492	62	2.250	3.250	0.375	57	83	10	21702-2393	62	3.563	4.625	0.500	91	117	13
21702-1504	62	2.250	3.500	0.500	57	89	13	21702-2408	62	3.562	5.250	0.500	90	133	13
21702-1639	62	2.375	3.062	0.375	60	78	10	21702-2417	62	3.625	4.625	0.500	92	117	13
21702-1642	62	2.375	3.125	0.375	60	79	10	21702-2462	62	3.750	4.750	0.500	95	121	13
21702-1644	62	2.375	3.125	0.500	60	79	13	21702-2501	62	3.875	4.875	0.500	98	124	13
21702-1654	62	2.375	3.250	0.375	60	83	10	21702-2504	62	3.875	4.999	0.500	98	127	13
21702-1656	62	2.375	3.250	0.500	60	83	13	21702-2519	62	3.938	5.000	0.500	100	127	13
21702-1666	62	2.375	3.500	0.375	60	89	10	21702-2537	62	4.000	4.999	0.500	102	127	13
21702-1668	62	2.375	3.500	0.500	60	89	13	21702-2600	62	4.125	5.125	0.500	105	130	13
21702-1673	62	2.375	3.623	0.437	60	92	11	21702-2603	62	4.125	5.250	0.500	105	133	13
21702-1675	62	2.375	3.751	0.375	60	95	10	21702-2636	62	4.188	5.500	0.500	106	140	13
21702-1680	62	2.375	3.875	0.500	60	98	13	21702-2657	62	4.250	5.250	0.500	108	133	13
21702-1723	62	2.438	3.125	0.375	62	79	10	21702-2681	62	4.250	6.250	0.500	108	159	13
21702-1801	62	2.500	3.189	0.375	64	81	10	21702-2708	62	4.375	5.375	0.500	111	137	13
21702-1819	62	2.500	3.500	0.375	64	89	10	21702-2732	62	4.438	5.500	0.500	113	140	13
21702-1821	62	2.500	3.500	0.500	64	89	13	21702-2753	62	4.500	5.500	0.500	114	140	13
21702-1937	62	3.000	3.938	0.500	76	100	13	21702-2759	62	4.500	5.750	0.500	114	146	13
21702-1938	62	3.150	3.938	0.500	80	100	13	21702-2771	62	4.500	6.250	0.500	114	159	13
21702-1939	62	2.625	3.500	0.375	67	89	10	21702-2780	62	4.563	5.750	0.500	116	146	13
21702-1993	62	2.688	3.500	0.375	68	89	10	21702-2798	62	4.625	5.625	0.500	117	143	13
21702-2004	62	2.688	3.751	0.500	68	95	13	21702-2849	62	4.750	6.250	0.500	121	159	13
21702-2032	62	2.750	3.481	0.375	70	88	10	21702-2870	62	4.875	5.875	0.500	124	149	13
21702-2035	62	2.750	3.500	0.375	70	89	10	21702-2915	62	5.000	6.000	0.500	127	152	13
21702-2038	62	2.750	3.543	0.375	70	90	10	21702-2921	62	5.000	6.250	0.500	127	159	13
21702-2041	62	2.750	3.623	0.375	70	92	10	21702-2927	62	5.000	6.500	0.500	127	165	13
21702-2044	62	2.750	3.751	0.375	70	95	10	21702-3003	62	8.000	10.000	0.625	203	254	16
21702-2046	62	2.750	3.751	0.500	70	95	13	21702-3095	62	5.313	6.500	0.500	135	165	13
21702-2049	62	2.750	3.875	0.500	70	98	13	21702-3129	62	5.375	6.625	0.563	137	168	14
21702-2077	62	2.813	3.500	0.375	71	89	10	21702-3176	62	5.500	6.500	0.500	140	165	13
21702-2101	62	2.844	3.751	0.375	72	95	10	21702-3184	62	5.500	6.750	0.625	140	171	16
21702-2118	62	2.875	3.751	0.375	73	95	10	21702-3277	62	5.750	6.750	0.625	146	171	16
21702-2120	62	2.875	3.751	0.500	73	95	13	21702-3278	62	5.750	6.875	0.500	146	175	13
21702-2146	62	2.938	3.751	0.375	75	95	10	21702-3282	62	5.750	7.000	0.563	146	178	14
21702-2147	62	2.938	3.750	0.438	75	95	11	21702-3355	62	6.000	7.000	0.500	152	178	13
21702-2154	62	2.938	4.003	0.500	75	102	13	21702-3363	62	6.000	7.250	0.625	152	184	16
21702-2168	62	3.000	3.751	0.375	76	95	10	21702-3367	62	6.000	7.500	0.500	152	191	13
21702-2171	62	3.000	3.875	0.375	76	98	10	21702-3405	62	6.250	7.750	0.750	159	197	19
21702-2172	62	3.000	3.875	0.438	76	98	11	21702-3456	62	6.750	7.750	0.625	171	197	16
21702-2180	62	3.000	4.249	0.500	76	108	13	21702-3474	62	6.875	7.875	0.625	175	200	16
21702-2186	62	3.000	4.500	0.500	76	114	13	21702-3480	62	6.875	8.250	0.625	175	210	16
21702-2198	62	3.000	5.000	0.500	76	127	13	21702-3492	62	7.000	8.000	0.625	178	203	16
21702-2201	62	3.063	4.125	0.500	78	105	13	21702-3518	62	7.250	8.250	0.625	184	210	16
21702-2225	62	3.125	4.125	0.500	79	105	13	21702-3522	62	7.250	8.500	0.625	184	216	16
21702-2237	62	3.125	4.625	0.500	79	117	13	21702-3544	62	7.500	8.500	0.625	191	216	16
21702-2261	62	3.188	4.750	0.500	81	121	13	21702-3552	62	7.500	9.000	0.625	191	229	16
21702-2270	62	3.250	4.249	0.500	83	108	13	21702-3558	62	7.625	8.625	0.625	194	219	16

All dimensions are in inches. Preferred sizes are indicated with **bold** type face.

Sizes listed are for standard nitrile elements, except Models 25 and 62 which have PTFE elements. Other material available on inquiry only.

## Oil Seals by Model Number

Product Code	Model	Inches			MM			Product Code	Model	Inches			MM		
		ID	OD	Width	ID	OD	Width			ID	OD	Width	ID	OD	Width
21702-3578	62	7.750	9.250	0.625	197	235	16	21767-0772	62	1.625	2.625	0.375	41	67	10
21702-3600	62	8.000	9.500	0.625	203	241	16	21767-0829	62	1.688	2.437	0.375	43	62	10
21702-3608	62	8.375	9.750	0.750	213	248	19	21767-1048	62	1.875	2.750	0.375	48	70	10
21702-3624	62	9.000	11.000	1.000	229	279	25	21767-1129	62	1.938	2.875	0.375	49	73	10
21702-3869	62	0.562	1.000	0.312	14	25	8	21767-1189	62	2.000	2.750	0.375	51	70	10
21702-3877	62	1.188	2.048	0.375	30	52	10	21767-1204	62	2.000	3.000	0.375	51	76	10
21702-3917	62	6.437	7.500	0.500	163	191	13	21767-1420	62	2.188	3.250	0.375	56	83	10
21702-3921	62	8.000	9.500	0.688	203	241	17	21767-1472	62	2.250	2.997	0.437	57	76	11
21702-3927	62	8.063	10.000	1.000	205	254	25	21767-1474	62	2.250	3.000	0.375	57	76	10
21702-3937	62	8.500	10.000	0.750	216	254	19	21767-1723	62	2.437	3.125	0.375	62	79	10
21702-3946	62	8.750	10.250	0.688	222	260	17	21767-1993	62	2.688	3.500	0.375	68	89	10
21702-3951	62	8.750	10.750	0.750	222	273	19	21767-2345	62	3.438	4.500	0.500	87	114	13
21702-3967	62	9.250	11.250	0.750	235	286	19	21767-2366	62	3.500	4.500	0.500	89	114	13
21702-4017	62	10.500	12.500	0.813	267	318	21	21767-2657	62	4.250	5.250	0.500	108	133	13
21702-4072	62	12.000	14.000	0.813	305	356	21	21767-2778	62	2.559	3.543	0.500	65	90	13
21702-4129	62	13.750	15.750	0.812	349	400	21	21767-2915	62	5.000	6.000	0.500	127	152	13
21702-4132	62	14.000	15.500	0.750	356	394	19	21767-3406	62	6.375	7.375	0.500	162	187	13
21702-4502	62	8.500	10.000	0.625	216	254	16	21767-3492	62	7.000	8.000	0.625	178	203	16
21702-4503	62	9.000	10.000	0.625	229	254	16	21767-3741	62	18.000	19.500	0.750	457	495	19
21702-4507	62	9.000	10.500	0.625	229	267	16	21767-3869	62	0.563	1.000	0.313	14	25	8
21702-4557	62	3.000	4.000	0.500	76	102	13	21767-4492	62	7.313	8.375	0.625	186	213	16
21702-4560	62	6.500	7.500	0.500	165	191	13	21767-4582	62	2.000	2.625	0.312	51	67	8
21702-4651	62	4.000	5.000	0.500	102	127	13	21767-4651	62	4.000	5.000	0.500	102	127	13
21702-4687	62	0.984	2.048	0.038	25	52	1	21767-6233	62	0.938	1.375	0.313	24	35	8
21702-4798	62	1.500	2.125	0.375	38	54	10	21767-8378	62	2.563	3.347	0.375	65	85	10
21702-4845	62	2.500	3.938	0.375	64	100	10	21767-9822	62	1.750	2.375	0.313	44	60	8
21702-5105	62	0.669	1.375	0.313	17	35	8	21158-0001	63	0.281	0.750	0.250	7	19	6
21702-5339	62	9.844	11.024	0.591	250	280	15	21158-0005	63	0.313	0.750	0.250	8	19	6
21702-5357	62	8.661	9.844	0.591	220	250	15	21158-0006	63	0.313	0.750	0.313	8	19	8
21702-5773	62	11.500	13.000	0.813	292	330	21	21158-0007	63	0.313	0.875	0.250	8	22	6
21702-5991	62	14.000	15.750	0.687	356	400	17	21158-0008	63	0.313	0.875	0.313	8	22	8
21702-6655	62	1.375	2.047	0.375	35	52	10	21158-0009	63	0.344	0.750	0.250	9	19	6
21702-7386	62	1.375	2.000	0.375	35	51	10	21158-0011	63	0.344	0.875	0.250	9	22	6
21702-8102	62	0.500	1.378	0.313	13	35	8	21158-0013	63	0.375	0.750	0.250	10	19	6
21702-8168	62	3.750	4.885	0.500	95	124	13	21158-0014	63	0.375	0.750	0.312	10	19	8
21702-8373	62	2.438	3.150	0.375	62	80	10	21158-0015	63	0.375	0.875	0.250	10	22	6
21702-8876	62	3.063	4.003	0.375	78	102	10	21158-0016	63	0.375	0.875	0.313	10	22	8
21702-9438	62	8.875	10.750	0.750	225	273	19	21158-0017	63	0.375	1.000	0.313	10	25	8
21702-9620	62	1.750	2.441	0.375	44	62	10	21158-0018	63	0.375	1.000	0.375	10	25	10
21702-9808	62	1.000	1.750	0.313	25	44	8	21158-0019	63	0.375	1.125	0.313	10	29	8
21767-0049	62	0.500	1.000	0.313	13	25	8	21158-0021	63	0.375	1.250	0.313	10	32	8
21767-0087	62	0.625	1.125	0.313	16	29	8	21158-0027	63	0.406	1.000	0.313	10	25	8
21767-0089	62	0.625	1.250	0.313	16	32	8	21158-0029	63	0.406	1.125	0.313	10	29	8
21767-0139	62	0.750	1.250	0.313	19	32	8	21158-0034	63	0.406	1.375	0.375	10	35	10
21767-0141	62	0.750	1.375	0.313	19	35	8	21158-0035	63	0.438	0.875	0.313	11	22	8
21767-0153	62	0.750	1.875	0.375	19	48	10	21158-0037	63	0.438	1.000	0.313	11	25	8
21767-0159	62	0.781	1.375	0.313	20	35	8	21158-0038	63	0.437	1.000	0.375	11	25	10
21767-0213	62	0.875	1.375	0.313	22	35	8	21158-0039	63	0.438	1.125	0.313	11	29	8
21767-0287	62	1.000	1.500	0.313	25	38	8	21158-0041	63	0.438	1.250	0.313	11	32	8
21767-0301	62	1.000	2.000	0.375	25	51	10	21158-0042	63	0.437	1.250	0.375	11	32	10
21767-0351	62	1.125	1.625	0.313	29	41	8	21158-0043	63	0.469	1.000	0.313	12	25	8
21767-0357	62	1.125	1.875	0.375	29	48	10	21158-0045	63	0.469	1.125	0.313	12	29	8
21767-0427	62	1.250	2.000	0.375	32	51	10	21158-0047	63	0.469	1.250	0.312	12	32	8
21767-0535	62	1.375	2.062	0.375	35	52	10	21158-0049	63	0.500	1.000	0.313	13	25	8
21767-0643	62	1.500	2.250	0.375	38	57	10	21158-0050	63	0.500	1.000	0.375	13	25	10
21767-0769	62	1.625	2.500	0.375	41	64	10	21158-0051	63	0.500	1.125	0.313	13	29	8

All dimensions are in inches. Preferred sizes are indicated with **bold** type face.  
 Sizes listed are for standard nitrile elements, except Models 25 and 62 which have PTFE elements. Other material available on inquiry only.



## Oil Seals by Model Number

Product Code	Model	Inches			MM			Product Code	Model	Inches			MM		
		ID	OD	Width	ID	OD	Width			ID	OD	Width	ID	OD	Width
21158-0052	63	0.500	1.125	0.375	13	29	10	21158-0142	63	0.750	1.375	0.375	19	35	10
21158-0053	63	0.500	1.250	0.313	13	32	8	21158-0143	63	0.750	1.500	0.313	19	38	8
21158-0054	63	0.500	1.250	0.375	13	32	10	21158-0144	63	0.750	1.500	0.375	19	38	10
21158-0055	63	0.500	1.375	0.313	13	35	8	21158-0145	63	0.750	1.575	0.313	19	40	8
21158-0057	63	0.500	1.500	0.313	13	38	8	21158-0147	63	0.750	1.625	0.313	19	41	8
21158-0058	63	0.500	1.500	0.375	13	38	10	21158-0149	63	0.750	1.750	0.375	19	44	10
21158-0059	63	0.531	1.125	0.313	13	29	8	21158-0150	63	0.750	1.750	0.438	19	44	11
21158-0061	63	0.531	1.250	0.313	13	32	8	21158-0151	63	0.750	1.828	0.375	19	46	10
21158-0063	63	0.531	1.375	0.313	13	35	8	21158-0152	63	0.750	1.828	0.437	19	46	11
21158-0065	63	0.531	1.500	0.313	13	38	8	21158-0153	63	0.750	1.875	0.375	19	48	10
21158-0067	63	0.563	1.125	0.313	14	29	8	21158-0155	63	0.750	1.984	0.375	19	50	10
21158-0068	63	0.562	1.125	0.375	14	29	10	21158-0157	63	0.781	1.250	0.313	20	32	8
21158-0069	63	0.563	1.250	0.313	14	32	8	21158-0158	63	0.781	1.250	0.375	20	32	10
21158-0070	63	0.563	1.250	0.375	14	32	10	21158-0159	63	0.781	1.375	0.313	20	35	8
21158-0071	63	0.563	1.375	0.313	14	35	8	21158-0161	63	0.781	1.500	0.313	20	38	8
21158-0073	63	0.563	1.500	0.313	14	38	8	21158-0162	63	0.781	1.500	0.375	20	38	10
21158-0075	63	0.563	1.575	0.313	14	40	8	21158-0163	63	0.781	1.575	0.313	20	40	8
21158-0077	63	0.594	1.125	0.313	15	29	8	21158-0165	63	0.781	1.625	0.312	20	41	8
21158-0078	63	0.594	1.125	0.375	15	29	10	21158-0167	63	0.781	1.750	0.375	20	44	10
21158-0079	63	0.594	1.250	0.313	15	32	8	21158-0169	63	0.781	1.828	0.375	20	46	10
21158-0081	63	0.594	1.375	0.313	15	35	8	21158-0171	63	0.781	1.875	0.375	20	48	10
21158-0082	63	0.594	1.375	0.375	15	35	10	21158-0172	63	0.781	1.875	0.437	20	48	11
21158-0083	63	0.594	1.500	0.313	15	38	8	21158-0173	63	0.781	1.984	0.375	20	50	10
21158-0085	63	0.594	1.575	0.312	15	40	8	21158-0175	63	0.813	1.250	0.313	21	32	8
21158-0087	63	0.625	1.125	0.313	16	29	8	21158-0176	63	0.812	1.250	0.375	21	32	10
21158-0088	63	0.625	1.125	0.375	16	29	10	21158-0177	63	0.813	1.375	0.313	21	35	8
21158-0089	63	0.625	1.250	0.313	16	32	8	21158-0179	63	0.813	1.500	0.313	21	38	8
21158-0090	63	0.625	1.250	0.375	16	32	10	21158-0180	63	0.813	1.500	0.375	21	38	10
21158-0091	63	0.625	1.375	0.313	16	35	8	21158-0181	63	0.813	1.575	0.313	21	40	8
21158-0093	63	0.625	1.500	0.313	16	38	8	21158-0182	63	0.813	1.575	0.375	21	40	10
21158-0095	63	0.625	1.575	0.313	16	40	8	21158-0183	63	0.813	1.625	0.313	21	41	8
21158-0097	63	0.656	1.125	0.313	17	29	8	21158-0185	63	0.813	1.750	0.375	21	44	10
21158-0099	63	0.656	1.250	0.313	17	32	8	21158-0187	63	0.812	1.828	0.375	21	46	10
21158-0100	63	0.656	1.250	0.375	17	32	10	21158-0189	63	0.813	1.875	0.375	21	48	10
21158-0101	63	0.656	1.375	0.313	17	35	8	21158-0191	63	0.813	1.984	0.375	21	50	10
21158-0103	63	0.656	1.500	0.313	17	38	8	21158-0192	63	0.813	1.984	0.438	21	50	11
21158-0104	63	0.656	1.500	0.375	17	38	10	21158-0193	63	0.844	1.375	0.313	21	35	8
21158-0105	63	0.656	1.575	0.313	17	40	8	21158-0197	63	0.844	1.575	0.312	21	40	8
21158-0107	63	0.656	1.625	0.313	17	41	8	21158-0199	63	0.844	1.625	0.313	21	41	8
21158-0109	63	0.688	1.125	0.313	17	29	8	21158-0201	63	0.844	1.750	0.375	21	44	10
21158-0111	63	0.688	1.250	0.313	17	32	8	21158-0207	63	0.844	1.984	0.375	21	50	10
21158-0112	63	0.687	1.250	0.375	17	32	10	21158-0213	63	0.875	1.375	0.313	22	35	8
21158-0113	63	0.688	1.375	0.313	17	35	8	21158-0214	63	0.875	1.375	0.375	22	35	10
21158-0115	63	0.688	1.500	0.313	17	38	8	21158-0215	63	0.875	1.500	0.313	22	38	8
21158-0116	63	0.687	1.500	0.375	17	38	10	21158-0216	63	0.875	1.500	0.375	22	38	10
21158-0121	63	0.719	1.250	0.313	18	32	8	21158-0217	63	0.875	1.575	0.313	22	40	8
21158-0123	63	0.719	1.375	0.313	18	35	8	21158-0219	63	0.875	1.625	0.313	22	41	8
21158-0124	63	0.719	1.375	0.375	18	35	10	21158-0220	63	0.875	1.625	0.375	22	41	10
21158-0125	63	0.719	1.500	0.313	18	38	8	21158-0221	63	0.875	1.750	0.375	22	44	10
21158-0126	63	0.719	1.499	0.375	18	38	10	21158-0222	63	0.875	1.750	0.437	22	44	11
21158-0129	63	0.719	1.625	0.313	18	41	8	21158-0223	63	0.875	1.828	0.375	22	46	10
21158-0133	63	0.719	1.828	0.375	18	46	10	21158-0224	63	0.875	1.828	0.437	22	46	11
21158-0135	63	0.719	1.875	0.375	18	48	10	21158-0225	63	0.875	1.875	0.375	22	48	10
21158-0139	63	0.750	1.250	0.313	19	32	8	21158-0226	63	0.875	1.875	0.437	22	48	11
21158-0140	63	0.750	1.250	0.375	19	32	10	21158-0227	63	0.875	1.984	0.375	22	50	10
21158-0141	63	0.750	1.375	0.313	19	35	8	21158-0228	63	0.875	1.984	0.437	22	50	11

All dimensions are in inches. Preferred sizes are indicated with **bold** type face.

Sizes listed are for standard nitrile elements, except Models 25 and 62 which have PTFE elements. Other material available on inquiry only.

## Oil Seals by Model Number

Product Code	Model	Inches			MM			Product Code	Model	Inches			MM		
		ID	OD	Width	ID	OD	Width			ID	OD	Width	ID	OD	Width
21158-0229	63	0.875	2.000	0.375	22	51	10	21158-0313	63	1.031	1.875	0.375	26	48	10
21158-0231	63	0.875	2.062	0.375	22	52	10	21158-0314	63	1.063	1.499	0.313	27	38	8
21158-0233	63	0.906	1.500	0.313	23	38	8	21158-0319	63	1.031	2.062	0.375	26	52	10
21158-0234	63	0.906	1.500	0.375	23	38	10	21158-0321	63	1.063	1.575	0.313	27	40	8
21158-0235	63	0.906	1.575	0.313	23	40	8	21158-0323	63	1.062	1.625	0.313	27	41	8
21158-0237	63	0.906	1.625	0.313	23	41	8	21158-0324	63	1.062	1.625	0.375	27	41	10
21158-0239	63	0.906	1.750	0.375	23	44	10	21158-0325	63	1.062	1.750	0.375	27	44	10
21158-0245	63	0.906	1.984	0.375	23	50	10	21158-0326	63	1.062	1.750	0.437	27	44	11
21158-0247	63	0.906	2.000	0.375	23	51	10	21158-0327	63	1.062	1.828	0.375	27	46	10
21158-0251	63	0.938	1.500	0.313	24	38	8	21158-0328	63	1.063	1.828	0.438	27	46	11
21158-0252	63	0.937	1.500	0.375	24	38	10	21158-0329	63	1.063	1.875	0.375	27	48	10
21158-0253	63	0.938	1.575	0.313	24	40	8	21158-0330	63	1.062	1.875	0.437	27	48	11
21158-0255	63	0.938	1.625	0.313	24	41	8	21158-0331	63	1.062	1.984	0.375	27	50	10
21158-0256	63	0.938	1.625	0.375	24	41	10	21158-0333	63	1.062	2.000	0.375	27	51	10
21158-0257	63	0.938	1.750	0.375	24	44	10	21158-0334	63	1.062	2.000	0.438	27	51	11
21158-0258	63	0.938	1.750	0.438	24	44	11	21158-0335	63	1.062	2.062	0.375	27	52	10
21158-0259	63	0.938	1.828	0.375	24	46	10	21158-0336	63	1.062	2.062	0.437	27	52	11
21158-0260	63	0.938	1.828	0.438	24	46	11	21158-0337	63	1.093	1.625	0.313	28	41	8
21158-0261	63	0.938	1.875	0.375	24	48	10	21158-0339	63	1.094	1.750	0.375	28	44	10
21158-0265	63	0.937	2.000	0.375	24	51	10	21158-0341	63	1.094	1.828	0.375	28	46	10
21158-0267	63	0.938	2.062	0.375	24	52	10	21158-0344	63	1.093	1.875	0.437	28	48	11
21158-0269	63	0.969	1.500	0.313	25	38	8	21158-0346	63	1.093	1.984	0.437	28	50	11
21158-0270	63	0.969	1.500	0.375	25	38	10	21158-0347	63	1.093	2.000	0.375	28	51	10
21158-0271	63	0.969	1.575	0.313	25	40	8	21158-0349	63	1.094	2.062	0.375	28	52	10
21158-0273	63	0.969	1.625	0.313	25	41	8	21158-0351	63	1.125	1.625	0.313	29	41	8
21158-0275	63	0.969	1.750	0.375	25	44	10	21158-0352	63	1.125	1.625	0.375	29	41	10
21158-0277	63	0.969	1.828	0.375	25	46	10	21158-0353	63	1.125	1.750	0.375	29	44	10
21158-0278	63	0.969	1.828	0.438	25	46	11	21158-0354	63	1.125	1.750	0.437	29	44	11
21158-0279	63	0.969	1.875	0.375	25	48	10	21158-0355	63	1.125	1.828	0.375	29	46	10
21158-0281	63	0.969	1.984	0.375	25	50	10	21158-0356	63	1.125	1.828	0.438	29	46	11
21158-0282	63	0.969	1.686	0.313	25	43	8	21158-0357	63	1.125	1.875	0.375	29	48	10
21158-0283	63	0.969	2.000	0.375	25	51	10	21158-0358	63	1.125	1.875	0.438	29	48	11
21158-0285	63	0.969	2.062	0.375	25	52	10	21158-0359	63	1.125	2.000	0.375	29	51	10
21158-0286	63	0.969	2.062	0.437	25	52	11	21158-0360	63	1.125	2.000	0.438	29	51	11
21158-0287	63	1.000	1.500	0.313	25	38	8	21158-0361	63	1.125	2.062	0.375	29	52	10
21158-0288	63	1.000	1.500	0.375	25	38	10	21158-0362	63	1.125	2.062	0.437	29	52	11
21158-0289	63	1.000	1.575	0.313	25	40	8	21158-0363	63	1.156	1.875	0.375	29	48	10
21158-0290	63	1.000	1.575	0.375	25	40	10	21158-0365	63	1.156	1.984	0.375	29	50	10
21158-0291	63	1.000	1.625	0.313	25	41	8	21158-0367	63	1.156	2.000	0.375	29	51	10
21158-0292	63	1.000	1.625	0.375	25	41	10	21158-0369	63	1.156	2.062	0.375	29	52	10
21158-0293	63	1.000	1.750	0.375	25	44	10	21158-0370	63	1.156	2.063	0.438	29	52	11
21158-0294	63	1.000	1.750	0.438	25	44	11	21158-0372	63	1.156	2.106	0.437	29	53	11
21158-0295	63	1.000	1.828	0.375	25	46	10	21158-0374	63	1.156	2.125	0.375	29	54	10
21158-0296	63	1.000	1.828	0.438	25	46	11	21158-0377	63	1.156	2.250	0.375	29	57	10
21158-0297	63	1.000	1.875	0.375	25	48	10	21158-0380	63	1.156	2.375	0.375	29	60	10
21158-0298	63	1.000	1.875	0.437	25	48	11	21158-0383	63	1.188	1.875	0.375	30	48	10
21158-0299	63	1.000	1.984	0.375	25	50	10	21158-0384	63	1.187	1.875	0.437	30	48	11
21158-0301	63	1.000	2.000	0.375	25	51	10	21158-0385	63	1.188	1.984	0.375	30	50	10
21158-0302	63	1.000	2.000	0.438	25	51	11	21158-0386	63	1.187	1.984	0.437	30	50	11
21158-0303	63	1.000	2.062	0.375	25	52	10	21158-0387	63	1.188	2.000	0.375	30	51	10
21158-0304	63	1.000	2.062	0.437	25	52	11	21158-0388	63	1.188	2.000	0.438	30	51	11
21158-0305	63	1.031	1.575	0.313	26	40	8	21158-0389	63	1.188	2.062	0.375	30	52	10
21158-0307	63	1.031	1.625	0.313	26	41	8	21158-0390	63	1.188	2.062	0.438	30	52	11
21158-0308	63	1.031	1.625	0.375	26	41	10	21158-0394	63	1.188	2.125	0.375	30	54	10
21158-0310	63	1.000	1.686	0.313	25	43	8	21158-0397	63	1.188	2.250	0.375	30	57	10
21158-0311	63	1.063	1.686	0.313	27	43	8	21158-0399	63	1.188	2.250	0.500	30	57	13

All dimensions are in inches. Preferred sizes are indicated with **bold** type face. Sizes listed are for standard nitrile elements, except Models 25 and 62 which have PTFE elements. Other material available on inquiry only.

## Oil Seals by Model Number

Product Code	Model	Inches			MM			Product Code	Model	Inches			MM		
		ID	OD	Width	ID	OD	Width			ID	OD	Width	ID	OD	Width
21158-0400	63	1.188	2.375	0.375	30	60	10	21158-0545	63	1.375	2.250	0.438	35	57	11
21158-0402	63	1.188	2.375	0.500	30	60	13	21158-0546	63	1.375	2.250	0.500	35	57	13
21158-0403	63	1.219	1.984	0.375	31	50	10	21158-0547	63	1.375	2.375	0.375	35	60	10
21158-0405	63	1.219	2.000	0.375	31	51	10	21158-0548	63	1.375	2.375	0.438	35	60	11
21158-0415	63	1.219	2.250	0.375	31	57	10	21158-0549	63	1.375	2.375	0.500	35	60	13
21158-0421	63	1.219	2.437	0.375	31	62	10	21158-0550	63	1.375	2.437	0.375	35	62	10
21158-0424	63	1.250	1.984	0.375	32	50	10	21158-0551	63	1.375	2.437	0.437	35	62	11
21158-0425	63	1.250	1.984	0.437	32	50	11	21158-0553	63	1.375	2.497	0.375	35	63	10
21158-0426	63	1.250	1.984	0.500	32	50	13	21158-0554	63	1.375	2.497	0.437	35	63	11
21158-0427	63	1.250	2.000	0.375	32	51	10	21158-0555	63	1.375	2.497	0.500	35	63	13
21158-0428	63	1.250	2.000	0.438	32	51	11	21158-0556	63	1.375	2.500	0.375	35	64	10
21158-0430	63	1.250	2.062	0.375	32	52	10	21158-0559	63	1.375	2.625	0.375	35	67	10
21158-0431	63	1.250	2.062	0.437	32	52	11	21158-0562	63	1.375	2.561	0.375	35	65	10
21158-0433	63	1.250	2.106	0.375	32	53	10	21158-0565	63	1.406	2.125	0.375	36	54	10
21158-0436	63	1.250	2.125	0.375	32	54	10	21158-0566	63	1.406	2.125	0.438	36	54	11
21158-0437	63	1.250	2.125	0.437	32	54	11	21158-0568	63	1.406	2.250	0.375	36	57	10
21158-0438	63	1.250	2.125	0.500	32	54	13	21158-0571	63	1.406	2.375	0.375	36	60	10
21158-0439	63	1.250	2.250	0.375	32	57	10	21158-0583	63	1.406	2.625	0.375	36	67	10
21158-0440	63	1.250	2.250	0.437	32	57	11	21158-0592	63	1.438	2.125	0.375	37	54	10
21158-0441	63	1.250	2.250	0.500	32	57	13	21158-0593	63	1.437	2.125	0.437	36	54	11
21158-0442	63	1.250	2.375	0.375	32	60	10	21158-0595	63	1.438	2.250	0.375	37	57	10
21158-0443	63	1.250	2.375	0.437	32	60	11	21158-0597	63	1.437	2.250	0.500	36	57	13
21158-0445	63	1.250	2.437	0.375	32	62	10	21158-0598	63	1.438	2.375	0.375	37	60	10
21158-0446	63	1.250	2.437	0.438	32	62	11	21158-0599	63	1.437	2.375	0.437	36	60	11
21158-0448	63	1.281	1.984	0.375	33	50	10	21158-0600	63	1.438	2.375	0.500	37	60	13
21158-0451	63	1.281	2.000	0.375	33	51	10	21158-0601	63	1.438	2.437	0.375	37	62	10
21158-0454	63	1.281	2.062	0.375	33	52	10	21158-0603	63	1.437	2.437	0.500	36	62	13
21158-0463	63	1.281	2.250	0.375	33	57	10	21158-0607	63	1.438	2.500	0.375	37	64	10
21158-0475	63	1.281	2.500	0.375	33	64	10	21158-0608	63	1.437	2.500	0.437	36	64	11
21158-0478	63	1.313	1.984	0.375	33	50	10	21158-0609	63	1.437	2.500	0.500	36	64	13
21158-0481	63	1.313	2.000	0.375	33	51	10	21158-0610	63	1.438	2.625	0.375	37	67	10
21158-0482	63	1.312	2.000	0.437	33	51	11	21158-0613	63	1.438	2.686	0.375	37	68	10
21158-0484	63	1.313	2.062	0.375	33	52	10	21158-0616	63	1.469	2.250	0.375	37	57	10
21158-0485	63	1.313	2.062	0.438	33	52	11	21158-0619	63	1.469	2.375	0.375	37	60	10
21158-0490	63	1.313	2.125	0.375	33	54	10	21158-0621	63	1.469	2.375	0.500	37	60	13
21158-0491	63	1.313	2.125	0.438	33	54	11	21158-0622	63	1.469	2.437	0.375	37	62	10
21158-0493	63	1.313	2.250	0.375	33	57	10	21158-0628	63	1.469	2.500	0.375	37	64	10
21158-0495	63	1.313	2.250	0.500	33	57	13	21158-0634	63	1.469	2.686	0.375	37	68	10
21158-0496	63	1.313	2.375	0.375	33	60	10	21158-0638	63	1.469	2.750	0.437	37	70	11
21158-0498	63	1.313	2.375	0.500	33	60	13	21158-0643	63	1.500	2.250	0.375	38	57	10
21158-0499	63	1.312	2.437	0.375	33	62	10	21158-0644	63	1.500	2.250	0.438	38	57	11
21158-0505	63	1.313	2.500	0.375	33	64	10	21158-0645	63	1.500	2.250	0.500	38	57	13
21158-0511	63	1.344	2.106	0.375	34	53	10	21158-0646	63	1.500	2.375	0.375	38	60	10
21158-0513	63	2.406	3.500	0.500	61	89	13	21158-0647	63	1.500	2.375	0.437	38	60	11
21158-0517	63	1.344	2.250	0.375	34	57	10	21158-0648	63	1.500	2.375	0.500	38	60	13
21158-0523	63	1.344	2.437	0.375	34	62	10	21158-0649	63	1.500	2.437	0.375	38	62	10
21158-0525	63	1.344	2.437	0.500	34	62	13	21158-0651	63	1.500	2.437	0.500	38	62	13
21158-0529	63	1.344	2.500	0.375	34	64	10	21158-0652	63	1.500	2.497	0.375	38	63	10
21158-0532	63	1.344	2.625	0.375	34	67	10	21158-0654	63	1.500	2.497	0.500	38	63	13
21158-0535	63	1.375	2.062	0.375	35	52	10	21158-0655	63	1.500	2.500	0.375	38	64	10
21158-0538	63	1.375	2.106	0.375	35	53	10	21158-0656	63	1.500	2.500	0.437	38	64	11
21158-0539	63	1.375	2.106	0.437	35	53	11	21158-0657	63	1.500	2.500	0.500	38	64	13
21158-0541	63	1.375	2.125	0.375	35	54	10	21158-0658	63	1.500	2.625	0.375	38	67	10
21158-0542	63	1.375	2.125	0.438	35	54	11	21158-0659	63	1.500	2.625	0.437	38	67	11
21158-0543	63	1.375	2.125	0.500	35	54	13	21158-0661	63	1.500	2.686	0.375	38	68	10
21158-0544	63	1.375	2.250	0.375	35	57	10	21158-0664	63	1.500	2.750	0.375	38	70	10

All dimensions are in inches. Preferred sizes are indicated with **bold** type face.

Sizes listed are for standard nitrile elements, except Models 25 and 62 which have PTFE elements. Other material available on inquiry only.

## Oil Seals by Model Number

Product Code	Model	Inches			MM			Product Code	Model	Inches			MM		
		ID	OD	Width	ID	OD	Width			ID	OD	Width	ID	OD	Width
21158-0665	63	1.500	2.750	0.437	38	70	11	21158-0817	63	1.656	2.875	0.375	42	73	10
21158-0667	63	1.500	2.756	0.375	38	70	10	21158-0826	63	1.688	2.375	0.375	43	60	10
21158-0668	63	1.500	2.756	0.437	38	70	11	21158-0828	63	1.688	2.375	0.500	43	60	13
21158-0670	63	1.531	2.250	0.375	39	57	10	21158-0829	63	1.688	2.437	0.375	43	62	10
21158-0679	63	1.531	2.497	0.375	39	63	10	21158-0830	63	1.688	2.437	0.437	43	62	11
21158-0682	63	1.531	2.500	0.375	39	64	10	21158-0832	63	1.688	2.497	0.375	43	63	10
21158-0685	63	1.531	2.625	0.375	39	67	10	21158-0835	63	1.688	2.500	0.375	43	64	10
21158-0687	63	1.969	3.062	0.375	50	78	10	21158-0836	63	1.688	2.500	0.437	43	64	11
21158-0693	63	1.531	2.750	0.500	39	70	13	21158-0837	63	1.688	2.500	0.500	43	64	13
21158-0700	63	1.563	2.250	0.375	40	57	10	21158-0838	63	1.688	2.625	0.375	43	67	10
21158-0703	63	1.563	2.375	0.375	40	60	10	21158-0840	63	1.688	2.625	0.500	43	67	13
21158-0704	63	1.563	2.375	0.438	40	60	11	21158-0841	63	1.687	2.686	0.375	43	68	10
21158-0706	63	1.563	2.437	0.375	40	62	10	21158-0843	63	1.688	2.686	0.500	43	68	13
21158-0708	63	1.563	2.437	0.500	40	62	13	21158-0844	63	1.688	2.750	0.375	43	70	10
21158-0712	63	1.563	2.500	0.375	40	64	10	21158-0846	63	1.688	2.750	0.500	43	70	13
21158-0714	63	1.563	2.500	0.500	40	64	13	21158-0848	63	1.688	2.756	0.437	43	70	11
21158-0715	63	1.563	2.625	0.375	40	67	10	21158-0849	63	1.688	2.756	0.500	43	70	13
21158-0717	63	1.563	2.625	0.500	40	67	13	21158-0853	63	1.688	2.875	0.375	43	73	10
21158-0718	63	1.563	2.686	0.375	40	68	10	21158-0855	63	1.687	2.875	0.500	43	73	13
21158-0721	63	1.563	2.750	0.375	40	70	10	21158-0859	63	1.688	3.000	0.375	43	76	10
21158-0722	63	1.562	2.750	0.437	40	70	11	21158-0862	63	1.719	2.437	0.375	44	62	10
21158-0727	63	1.563	2.783	0.375	40	71	10	21158-0868	63	1.719	2.500	0.375	44	64	10
21158-0728	63	1.563	2.783	0.438	40	71	11	21158-0871	63	1.719	2.625	0.375	44	67	10
21158-0730	63	1.594	2.375	0.375	40	60	10	21158-0874	63	1.719	2.686	0.375	44	68	10
21158-0739	63	1.594	2.500	0.375	40	64	10	21158-0877	63	1.719	2.750	0.375	44	70	10
21158-0744	63	1.594	2.625	0.500	40	67	13	21158-0883	63	1.719	2.783	0.375	44	71	10
21158-0750	63	1.594	2.750	0.500	40	70	13	21158-0885	63	1.719	2.783	0.500	44	71	13
21158-0751	63	1.594	2.756	0.375	40	70	10	21158-0886	63	1.719	2.875	0.375	44	73	10
21158-0757	63	1.594	2.875	0.375	40	73	10	21158-0887	63	1.719	2.875	0.437	44	73	11
21158-0758	63	1.625	2.188	0.375	41	56	10	21158-0892	63	1.719	3.000	0.375	44	76	10
21158-0760	63	1.625	2.375	0.375	41	60	10	21158-0898	63	1.750	2.437	0.375	44	62	10
21158-0762	63	1.625	2.375	0.500	41	60	13	21158-0899	63	1.750	2.437	0.438	44	62	11
21158-0763	63	1.625	2.437	0.375	41	62	10	21158-0901	63	1.750	2.497	0.375	44	63	10
21158-0764	63	1.625	2.437	0.437	41	62	11	21158-0904	63	1.750	2.500	0.375	44	64	10
21158-0765	63	1.625	2.437	0.500	41	62	13	21158-0905	63	1.750	2.500	0.437	44	64	11
21158-0766	63	1.625	2.497	0.375	41	63	10	21158-0906	63	1.750	2.500	0.500	44	64	13
21158-0767	63	1.625	2.497	0.437	41	63	11	21158-0907	63	1.750	2.625	0.375	44	67	10
21158-0769	63	1.625	2.500	0.375	41	64	10	21158-0908	63	1.750	2.625	0.437	44	67	11
21158-0771	63	1.625	2.500	0.500	41	64	13	21158-0909	63	1.750	2.625	0.500	44	67	13
21158-0772	63	1.625	2.625	0.375	41	67	10	21158-0910	63	1.750	2.686	0.375	44	68	10
21158-0774	63	1.625	2.625	0.500	41	67	13	21158-0911	63	1.750	2.686	0.437	44	68	11
21158-0775	63	1.625	2.686	0.375	41	68	10	21158-0912	63	1.750	2.686	0.500	44	68	13
21158-0777	63	1.625	2.686	0.500	41	68	13	21158-0913	63	1.750	2.750	0.375	44	70	10
21158-0778	63	1.625	2.750	0.375	41	70	10	21158-0914	63	1.750	2.750	0.437	44	70	11
21158-0780	63	1.625	2.750	0.500	41	70	13	21158-0915	63	1.750	2.750	0.500	44	70	13
21158-0781	63	1.625	2.756	0.375	41	70	10	21158-0916	63	1.750	2.756	0.375	44	70	10
21158-0782	63	1.625	2.756	0.437	41	70	11	21158-0918	63	1.750	2.756	0.500	44	70	13
21158-0787	63	1.625	2.875	0.375	41	73	10	21158-0919	63	1.750	2.783	0.375	44	71	10
21158-0788	63	1.625	2.875	0.437	41	73	11	21158-0921	63	1.750	2.783	0.500	44	71	13
21158-0789	63	1.625	2.875	0.500	41	73	13	21158-0922	63	1.750	2.875	0.375	44	73	10
21158-0799	63	1.656	2.500	0.375	42	64	10	21158-0923	63	1.750	2.875	0.437	44	73	11
21158-0804	63	1.656	2.625	0.500	42	67	13	21158-0924	63	1.750	2.875	0.500	44	73	13
21158-0805	63	1.656	2.686	0.375	42	68	10	21158-0927	63	1.750	2.997	0.500	44	76	13
21158-0807	63	1.656	2.686	0.500	42	68	13	21158-0928	63	1.750	3.000	0.375	44	76	10
21158-0808	63	1.656	2.750	0.375	42	70	10	21158-0930	63	1.750	3.000	0.500	44	76	13
21158-0810	63	1.656	2.750	0.500	42	70	13	21158-0931	63	1.750	3.062	0.375	44	78	10

All dimensions are in inches. Preferred sizes are indicated with **bold** type face.  
 Sizes listed are for standard nitrile elements, except Models 25 and 62 which have PTFE elements. Other material available on inquiry only.

## Oil Seals by Model Number

Product Code	Model	Inches			MM			Product Code	Model	Inches			MM		
		ID	OD	Width	ID	OD	Width			ID	OD	Width	ID	OD	Width
21158-0934	63	1.781	2.497	0.375	45	63	10	21158-1130	63	1.937	2.875	0.437	49	73	11
21158-0937	63	1.781	2.500	0.375	45	64	10	21158-1131	63	1.938	2.875	0.500	49	73	13
21158-0940	63	1.781	2.625	0.375	45	67	10	21158-1132	63	1.938	2.997	0.375	49	76	10
21158-0945	63	1.781	2.686	0.500	45	68	13	21158-1134	63	1.938	2.997	0.500	49	76	13
21158-0946	63	1.781	2.750	0.375	45	70	10	21158-1135	63	1.938	3.000	0.375	49	76	10
21158-0951	63	1.781	2.756	0.500	45	70	13	21158-1136	63	1.937	3.000	0.437	49	76	11
21158-0955	63	1.781	2.875	0.375	45	73	10	21158-1137	63	1.938	3.000	0.500	49	76	13
21158-0967	63	1.781	3.125	0.375	45	79	10	21158-1138	63	1.938	3.062	0.375	49	78	10
21158-0969	63	1.781	3.125	0.500	45	79	13	21158-1140	63	1.938	3.062	0.500	49	78	13
21158-0970	63	1.813	2.497	0.375	46	63	10	21158-1141	63	1.938	3.125	0.375	49	79	10
21158-0971	63	0.406	0.875	0.313	10	22	8	21158-1142	63	1.937	3.125	0.437	49	79	11
21158-0972	63	1.813	2.497	0.500	46	63	13	21158-1143	63	1.937	3.125	0.500	49	79	13
21158-0973	63	1.813	2.500	0.375	46	64	10	21158-1144	63	1.938	3.147	0.375	49	80	10
21158-0975	63	1.813	2.500	0.500	46	64	13	21158-1147	63	1.938	3.189	0.375	49	81	10
21158-0976	63	1.813	2.625	0.375	46	67	10	21158-1150	63	1.969	2.686	0.375	50	68	10
21158-0979	63	1.813	2.686	0.375	46	68	10	21158-1153	63	1.969	2.750	0.375	50	70	10
21158-0982	63	1.813	2.750	0.375	46	70	10	21158-1154	63	1.969	2.750	0.438	50	70	11
21158-0984	63	1.813	2.750	0.500	46	70	13	21158-1156	63	1.969	2.756	0.375	50	70	10
21158-0987	63	1.811	2.756	0.512	46	70	13	21158-1162	63	1.969	2.875	0.375	50	73	10
21158-0991	63	1.813	2.875	0.375	46	73	10	21158-1168	63	1.969	3.000	0.375	50	76	10
21158-0997	63	1.813	3.000	0.375	46	76	10	21158-1170	63	1.969	3.000	0.500	50	76	13
21158-1003	63	1.813	3.125	0.375	46	79	10	21158-1174	63	1.969	3.125	0.375	50	79	10
21158-1005	63	1.813	3.125	0.500	46	79	13	21158-1177	63	1.969	3.147	0.375	50	80	10
21158-1006	63	1.844	2.625	0.375	47	67	10	21158-1180	63	1.969	3.189	0.375	50	81	10
21158-1012	63	1.844	2.750	0.375	47	70	10	21158-1183	63	1.969	3.246	0.375	50	82	10
21158-1023	63	1.844	2.875	0.500	47	73	13	21158-1185	63	1.969	3.246	0.500	50	82	13
21158-1042	63	1.875	2.625	0.375	48	67	10	21158-1186	63	2.000	2.686	0.375	51	68	10
21158-1043	63	1.875	2.625	0.437	48	67	11	21158-1187	63	2.000	2.686	0.437	51	68	11
21158-1044	63	1.875	2.625	0.500	48	67	13	21158-1188	63	2.000	2.686	0.500	51	68	13
21158-1045	63	1.875	2.686	0.375	48	68	10	21158-1189	63	2.000	2.750	0.375	51	70	10
21158-1047	63	1.875	2.686	0.500	48	68	13	21158-1191	63	2.000	2.750	0.500	51	70	13
21158-1048	63	1.875	2.750	0.375	48	70	10	21158-1192	63	2.000	2.756	0.375	51	70	10
21158-1050	63	1.875	2.750	0.500	48	70	13	21158-1193	63	2.000	2.756	0.437	51	70	11
21158-1051	63	1.875	2.756	0.375	48	70	10	21158-1194	63	2.000	2.756	0.500	51	70	13
21158-1052	63	1.875	2.756	0.437	48	70	11	21158-1195	63	2.000	2.783	0.375	51	71	10
21158-1053	63	1.875	2.756	0.500	48	70	13	21158-1196	63	2.000	2.783	0.437	51	71	11
21158-1057	63	1.875	2.875	0.375	48	73	10	21158-1197	63	2.000	2.716	0.375	51	69	10
21158-1058	63	1.875	2.875	0.437	48	73	11	21158-1198	63	2.000	2.875	0.375	51	73	10
21158-1059	63	1.875	2.875	0.500	48	73	13	21158-1199	63	2.000	2.875	0.437	51	73	11
21158-1060	63	1.875	2.997	0.375	48	76	10	21158-1200	63	2.000	2.875	0.500	51	73	13
21158-1063	63	1.875	3.000	0.375	48	76	10	21158-1201	63	2.000	2.997	0.375	51	76	10
21158-1065	63	1.875	3.000	0.500	48	76	13	21158-1203	63	2.000	2.997	0.500	51	76	13
21158-1066	63	1.875	3.062	0.375	48	78	10	21158-1204	63	2.000	3.000	0.375	51	76	10
21158-1069	63	1.875	3.125	0.375	48	79	10	21158-1205	63	2.000	3.000	0.438	51	76	11
21158-1071	63	1.875	3.125	0.500	48	79	13	21158-1206	63	2.000	3.000	0.500	51	76	13
21158-1075	63	1.875	3.189	0.375	48	81	10	21158-1207	63	2.000	3.062	0.375	51	78	10
21158-1084	63	1.906	2.750	0.375	48	70	10	21158-1210	63	2.000	3.125	0.375	51	79	10
21158-1093	63	1.906	2.875	0.375	48	73	10	21158-1211	63	2.000	2.745	0.375	51	70	10
21158-1114	63	1.938	2.625	0.375	49	67	10	21158-1212	63	2.000	3.125	0.500	51	79	13
21158-1116	63	1.938	2.625	0.500	49	67	13	21158-1215	63	2.000	3.147	0.500	51	80	13
21158-1117	63	1.938	2.686	0.375	49	68	10	21158-1216	63	2.000	3.189	0.375	51	81	10
21158-1119	63	1.937	2.686	0.500	49	68	13	21158-1217	63	2.000	3.189	0.438	51	81	11
21158-1120	63	1.938	2.750	0.375	49	70	10	21158-1218	63	2.000	3.189	0.500	51	81	13
21158-1123	63	1.938	2.756	0.375	49	70	10	21158-1219	63	2.000	3.246	0.375	51	82	10
21158-1128	63	1.937	2.783	0.500	49	71	13	21158-1221	63	2.000	3.246	0.500	51	82	13
21158-1129	63	1.938	2.875	0.375	49	73	10	21158-1228	63	2.031	3.000	0.375	52	76	10

All dimensions are in inches. Preferred sizes are indicated with **bold** type face.

Sizes listed are for standard nitrile elements, except Models 25 and 62 which have PTFE elements. Other material available on inquiry only.

## Oil Seals by Model Number

Product Code	Model	Inches			MM			Product Code	Model	Inches			MM		
		ID	OD	Width	ID	OD	Width			ID	OD	Width	ID	OD	Width
21158-1231	63	2.031	3.062	0.375	52	78	10	21158-1410	63	2.187	3.125	0.500	56	79	13
21158-1249	63	2.031	3.350	0.375	52	85	10	21158-1411	63	2.188	3.147	0.375	56	80	10
21158-1252	63	2.062	2.875	0.375	52	73	10	21158-1413	63	2.188	3.147	0.500	56	80	13
21158-1253	63	2.063	2.875	0.437	52	73	11	21158-1414	63	2.188	3.189	0.375	56	81	10
21158-1255	63	2.063	2.997	0.375	52	76	10	21158-1416	63	2.187	3.189	0.500	56	81	13
21158-1258	63	2.063	3.000	0.375	52	76	10	21158-1417	63	2.188	3.246	0.375	56	82	10
21158-1260	63	2.062	3.000	0.500	52	76	13	21158-1420	63	2.188	3.250	0.375	56	83	10
21158-1261	63	2.062	3.062	0.375	52	78	10	21158-1422	63	2.187	3.250	0.500	56	83	13
21158-1263	63	2.062	3.062	0.500	52	78	13	21158-1423	63	2.188	3.350	0.375	56	85	10
21158-1264	63	2.062	3.125	0.375	52	79	10	21158-1425	63	2.187	3.350	0.500	56	85	13
21158-1267	63	2.062	3.147	0.375	52	80	10	21158-1426	63	2.188	3.372	0.375	56	86	10
21158-1270	63	2.062	3.189	0.375	52	81	10	21158-1428	63	2.188	3.372	0.500	56	86	13
21158-1276	63	2.062	3.250	0.375	52	83	10	21158-1429	63	2.188	3.481	0.375	56	88	10
21158-1279	63	2.062	3.350	0.375	52	85	10	21158-1432	63	2.188	3.500	0.375	56	89	10
21158-1282	63	2.094	2.875	0.375	53	73	10	21158-1434	63	2.188	3.500	0.500	56	89	13
21158-1291	63	2.094	3.062	0.375	53	78	10	21158-1438	63	2.219	3.000	0.375	56	76	10
21158-1306	63	2.094	3.250	0.375	53	83	10	21158-1468	63	2.219	3.500	0.375	56	89	10
21158-1315	63	2.094	3.481	0.375	53	88	10	21158-1471	63	2.250	2.997	0.375	57	76	10
21158-1318	63	2.094	3.500	0.375	53	89	10	21158-1473	63	2.250	2.997	0.500	57	76	13
21158-1321	63	2.125	2.875	0.375	54	73	10	21158-1474	63	2.250	3.000	0.375	57	76	10
21158-1322	63	2.125	2.875	0.437	54	73	11	21158-1475	63	2.250	3.000	0.438	57	76	11
21158-1323	63	2.125	2.875	0.500	54	73	13	21158-1476	63	2.250	3.000	0.500	57	76	13
21158-1324	63	2.125	2.997	0.375	54	76	10	21158-1477	63	2.250	3.062	0.375	57	78	10
21158-1326	63	2.125	2.997	0.500	54	76	13	21158-1480	63	2.250	3.125	0.375	57	79	10
21158-1327	63	2.125	3.000	0.375	54	76	10	21158-1482	63	2.250	3.125	0.500	57	79	13
21158-1329	63	2.125	3.000	0.500	54	76	13	21158-1483	63	2.250	3.147	0.375	57	80	10
21158-1330	63	2.125	3.062	0.375	54	78	10	21158-1485	63	2.250	3.147	0.500	57	80	13
21158-1331	63	2.125	3.062	0.437	54	78	11	21158-1486	63	2.250	3.189	0.375	57	81	10
21158-1332	63	2.125	3.062	0.500	54	78	13	21158-1489	63	2.250	3.246	0.375	57	82	10
21158-1333	63	2.125	3.125	0.375	54	79	10	21158-1491	63	2.250	3.246	0.500	57	82	13
21158-1334	63	2.125	3.125	0.437	54	79	11	21158-1492	63	2.250	3.250	0.375	57	83	10
21158-1335	63	2.125	3.125	0.500	54	79	13	21158-1493	63	2.250	3.250	0.437	57	83	11
21158-1336	63	2.125	3.147	0.375	54	80	10	21158-1494	63	2.250	3.250	0.500	57	83	13
21158-1339	63	2.125	3.189	0.375	54	81	10	21158-1495	63	2.250	3.350	0.375	57	85	10
21158-1342	63	2.125	3.371	0.469	54	86	12	21158-1498	63	2.250	3.372	0.375	57	86	10
21158-1345	63	2.125	3.250	0.375	54	83	10	21158-1499	63	2.250	3.372	0.438	57	86	11
21158-1348	63	2.125	3.350	0.375	54	85	10	21158-1500	63	2.250	3.372	0.500	57	86	13
21158-1351	63	2.125	3.372	0.375	54	86	10	21158-1504	63	2.250	3.500	0.375	57	89	10
21158-1357	63	2.125	3.500	0.375	54	89	10	21158-1505	63	2.250	3.500	0.438	57	89	11
21158-1359	63	2.125	3.500	0.500	54	89	13	21158-1506	63	2.250	3.500	0.500	57	89	13
21158-1360	63	2.156	2.875	0.375	55	73	10	21158-1513	63	2.281	3.062	0.375	58	78	10
21158-1363	63	2.156	2.997	0.375	55	76	10	21158-1543	63	2.281	3.543	0.375	58	90	10
21158-1366	63	2.156	3.000	0.375	55	76	10	21158-1552	63	2.313	2.997	0.375	59	76	10
21158-1378	63	2.156	3.189	0.375	55	81	10	21158-1555	63	2.313	3.000	0.375	59	76	10
21158-1384	63	2.156	3.250	0.375	55	83	10	21158-1558	63	2.313	3.062	0.375	59	78	10
21158-1389	63	2.156	3.350	0.500	55	85	13	21158-1561	63	2.313	3.125	0.375	59	79	10
21158-1390	63	2.156	3.372	0.375	55	86	10	21158-1567	63	2.313	3.189	0.375	59	81	10
21158-1396	63	2.156	3.500	0.375	55	89	10	21158-1573	63	2.313	3.250	0.375	59	83	10
21158-1398	63	2.156	3.500	0.500	55	89	13	21158-1575	63	2.312	3.250	0.500	59	83	13
21158-1399	63	2.188	2.875	0.375	56	73	10	21158-1578	63	2.312	3.350	0.500	59	85	13
21158-1400	63	2.188	2.875	0.437	56	73	11	21158-1579	63	2.313	3.372	0.375	59	86	10
21158-1402	63	2.188	3.000	0.375	56	76	10	21158-1582	63	2.312	3.481	0.375	59	88	10
21158-1404	63	2.188	3.000	0.500	56	76	13	21158-1585	63	2.313	3.500	0.375	59	89	10
21158-1405	63	2.188	3.062	0.375	56	78	10	21158-1587	63	2.313	3.500	0.500	59	89	13
21158-1406	63	2.188	3.062	0.438	56	78	11	21158-1594	63	2.313	3.751	0.375	59	95	10
21158-1408	63	2.188	3.125	0.375	56	79	10	21158-1596	63	2.313	3.751	0.500	59	95	13

All dimensions are in inches. Preferred sizes are indicated with **bold** type face.  
 Sizes listed are for standard nitrile elements, except Models 25 and 62 which have PTFE elements. Other material available on inquiry only.

## Oil Seals by Model Number

Product Code	Model	Inches			MM			Product Code	Model	Inches			MM		
		ID	OD	Width	ID	OD	Width			ID	OD	Width	ID	OD	Width
21158-1597	63	2.344	3.062	0.375	60	78	10	21158-1749	63	2.437	3.500	0.500	62	89	13
21158-1600	63	2.344	3.125	0.375	60	79	10	21158-1750	63	2.438	3.543	0.375	62	90	10
21158-1602	63	2.344	3.125	0.500	60	79	13	21158-1752	63	2.438	3.543	0.500	62	90	13
21158-1603	63	2.344	3.147	0.375	60	80	10	21158-1753	63	2.438	3.623	0.375	62	92	10
21158-1612	63	2.344	3.250	0.375	60	83	10	21158-1756	63	2.438	3.751	0.375	62	95	10
21158-1615	63	2.344	3.350	0.375	60	85	10	21158-1758	63	2.437	3.751	0.500	62	95	13
21158-1618	63	2.344	3.372	0.375	60	86	10	21158-1759	63	2.438	3.876	0.375	62	98	10
21158-1620	63	2.344	3.372	0.500	60	86	13	21158-1762	63	2.438	4.003	0.375	62	102	10
21158-1621	63	2.344	3.481	0.375	60	88	10	21158-1764	63	2.438	4.003	0.500	62	102	13
21158-1624	63	2.344	3.500	0.375	60	89	10	21158-1765	63	2.469	3.189	0.375	63	81	10
21158-1626	63	2.344	3.500	0.500	60	89	13	21158-1771	63	2.469	3.250	0.375	63	83	10
21158-1630	63	2.344	3.623	0.375	60	92	10	21158-1774	63	2.469	3.350	0.375	63	85	10
21158-1633	63	2.344	3.751	0.375	60	95	10	21158-1783	63	2.469	3.500	0.375	63	89	10
21158-1636	63	2.344	3.875	0.375	60	98	10	21158-1786	63	2.469	3.543	0.375	63	90	10
21158-1638	63	2.344	3.875	0.500	60	98	13	21158-1801	63	2.500	3.189	0.375	64	81	10
21158-1639	63	2.375	3.062	0.375	60	78	10	21158-1803	63	2.500	3.189	0.500	64	81	13
21158-1641	63	2.375	3.062	0.500	60	78	13	21158-1804	63	2.500	3.246	0.375	64	82	10
21158-1642	63	2.375	3.125	0.375	60	79	10	21158-1806	63	2.500	3.246	0.500	64	82	13
21158-1644	63	2.375	3.125	0.500	60	79	13	21158-1807	63	2.500	3.250	0.375	64	83	10
21158-1645	63	2.375	3.147	0.375	60	80	10	21158-1808	63	2.500	3.250	0.438	64	83	11
21158-1647	63	2.375	3.147	0.500	60	80	13	21158-1809	63	2.500	3.250	0.500	64	83	13
21158-1648	63	2.375	3.189	0.375	60	81	10	21158-1810	63	2.500	3.350	0.375	64	85	10
21158-1651	63	2.375	3.246	0.375	60	82	10	21158-1812	63	2.500	3.350	0.500	64	85	13
21158-1654	63	2.375	3.250	0.375	60	83	10	21158-1813	63	2.500	3.372	0.375	64	86	10
21158-1656	63	2.375	3.250	0.500	60	83	13	21158-1815	63	2.500	3.372	0.500	64	86	13
21158-1657	63	2.375	3.350	0.375	60	85	10	21158-1816	63	2.500	3.481	0.375	64	88	10
21158-1658	63	2.375	3.350	0.437	60	85	11	21158-1817	63	2.500	3.481	0.437	64	88	11
21158-1660	63	2.375	3.372	0.375	60	86	10	21158-1818	63	2.500	3.481	0.500	64	88	13
21158-1661	63	2.375	3.372	0.438	60	86	11	21158-1819	63	2.500	3.500	0.375	64	89	10
21158-1662	63	2.375	3.372	0.500	60	86	13	21158-1820	63	2.500	3.500	0.438	64	89	11
21158-1663	63	2.375	3.481	0.375	60	88	10	21158-1821	63	2.500	3.500	0.500	64	89	13
21158-1666	63	2.375	3.500	0.375	60	89	10	21158-1822	63	2.500	3.543	0.375	64	90	10
21158-1668	63	2.375	3.500	0.500	60	89	13	21158-1823	63	2.500	3.543	0.437	64	90	11
21158-1669	63	2.375	3.543	0.375	60	90	10	21158-1824	63	2.500	3.543	0.500	64	90	13
21158-1672	63	2.375	3.623	0.375	60	92	10	21158-1825	63	2.500	3.623	0.375	64	92	10
21158-1673	63	2.375	3.623	0.437	60	92	11	21158-1826	63	2.500	3.623	0.437	64	92	11
21158-1675	63	2.375	3.751	0.375	60	95	10	21158-1828	63	2.500	3.751	0.375	64	95	10
21158-1678	63	2.375	3.875	0.375	60	98	10	21158-1829	63	2.500	3.751	0.437	64	95	11
21158-1681	63	2.406	3.125	0.375	61	79	10	21158-1830	63	2.500	3.751	0.500	64	95	13
21158-1711	63	2.406	3.623	0.375	61	92	10	21158-1831	63	2.500	3.875	0.375	64	98	10
21158-1714	63	2.406	3.751	0.375	61	95	10	21158-1834	63	2.500	4.003	0.375	64	102	10
21158-1720	63	2.406	4.003	0.375	61	102	10	21158-1836	63	2.500	4.003	0.500	64	102	13
21158-1723	63	2.438	3.125	0.375	62	79	10	21158-1840	63	2.531	3.250	0.375	64	83	10
21158-1725	63	2.437	3.125	0.500	62	79	13	21158-1846	63	2.531	3.372	0.375	64	86	10
21158-1726	63	2.438	3.147	0.375	62	80	10	21158-1849	63	2.531	3.481	0.375	64	88	10
21158-1729	63	2.438	3.189	0.375	62	81	10	21158-1852	63	2.531	3.500	0.375	64	89	10
21158-1732	63	2.438	3.246	0.375	62	82	10	21158-1855	63	2.531	3.543	0.375	64	90	10
21158-1735	63	2.438	3.250	0.375	62	83	10	21158-1861	63	2.560	3.544	0.315	65	90	8
21158-1737	63	2.437	3.250	0.500	62	83	13	21158-1863	63	2.531	3.751	0.500	64	95	13
21158-1738	63	2.438	3.350	0.375	62	85	10	21158-1864	63	2.531	3.876	0.375	64	98	10
21158-1740	63	2.437	3.350	0.500	62	85	13	21158-1867	63	2.531	4.003	0.375	64	102	10
21158-1741	63	2.438	3.372	0.375	62	86	10	21158-1870	63	2.563	3.246	0.375	65	82	10
21158-1742	63	2.438	3.372	0.438	62	86	11	21158-1873	63	2.563	3.250	0.375	65	83	10
21158-1743	63	2.438	3.372	0.500	62	86	13	21158-1879	63	2.563	3.372	0.375	65	86	10
21158-1744	63	2.438	3.481	0.375	62	88	10	21158-1885	63	2.563	3.500	0.375	65	89	10
21158-1747	63	2.438	3.500	0.375	62	89	10	21158-1886	63	2.563	3.500	0.437	65	89	11

All dimensions are in inches. Preferred sizes are indicated with **bold** type face. Sizes listed are for standard nitrile elements, except Models 25 and 62 which have PTFE elements. Other material available on inquiry only.

## Oil Seals by Model Number

Product Code	Model	Inches			MM			Product Code	Model	Inches			MM		
		ID	OD	Width	ID	OD	Width			ID	OD	Width	ID	OD	Width
21158-1887	63	2.563	3.500	0.500	65	89	13	21158-2046	63	2.750	3.751	0.500	70	95	13
21158-1888	63	2.563	3.543	0.375	65	90	10	21158-2047	63	2.750	3.875	0.375	70	98	10
21158-1890	63	2.562	3.543	0.500	65	90	13	21158-2048	63	2.750	3.876	0.438	70	98	11
21158-1892	63	2.563	3.623	0.438	65	92	11	21158-2049	63	2.750	3.875	0.500	70	98	13
21158-1893	63	2.562	3.623	0.500	65	92	13	21158-2050	63	2.750	4.003	0.375	70	102	10
21158-1894	63	2.563	3.751	0.375	65	95	10	21158-2052	63	2.750	4.003	0.500	70	102	13
21158-1896	63	2.563	3.751	0.500	65	95	13	21158-2077	63	2.813	3.500	0.375	71	89	10
21158-1897	63	2.563	3.875	0.375	65	98	10	21158-2080	63	2.812	3.543	0.375	71	90	10
21158-1900	63	2.563	4.003	0.375	65	102	10	21158-2083	63	2.813	3.623	0.375	71	92	10
21158-1902	63	2.563	4.003	0.500	65	102	13	21158-2085	63	2.813	3.623	0.500	71	92	13
21158-1930	63	2.625	3.350	0.375	67	85	10	21158-2086	63	2.813	3.751	0.375	71	95	10
21158-1932	63	2.625	3.350	0.500	67	85	13	21158-2088	63	2.813	3.751	0.500	71	95	13
21158-1933	63	2.625	3.372	0.375	67	86	10	21158-2089	63	2.813	3.875	0.375	71	98	10
21158-1935	63	2.625	3.372	0.500	67	86	13	21158-2090	63	2.813	3.875	0.437	71	98	11
21158-1936	63	2.625	3.481	0.375	67	88	10	21158-2091	63	2.812	3.876	0.500	71	98	13
21158-1939	63	2.625	3.500	0.375	67	89	10	21158-2093	63	2.813	4.003	0.437	71	102	11
21158-1941	63	2.625	3.500	0.500	67	89	13	21158-2094	63	2.812	4.003	0.500	71	102	13
21158-1942	63	2.625	3.543	0.375	67	90	10	21158-2098	63	2.844	3.623	0.375	72	92	10
21158-1944	63	2.625	3.543	0.500	67	90	13	21158-2103	63	2.844	3.751	0.500	72	95	13
21158-1945	63	2.625	3.623	0.375	67	92	10	21158-2103	63	2.844	3.751	0.500	72	95	13
21158-1946	63	2.625	3.623	0.437	67	92	11	21158-2115	63	2.875	3.623	0.375	73	92	10
21158-1947	63	2.625	3.623	0.500	67	92	13	21158-2116	63	2.875	3.623	0.437	73	92	11
21158-1948	63	2.625	3.751	0.375	67	95	10	21158-2117	63	2.875	3.623	0.500	73	92	13
21158-1950	63	2.625	3.751	0.500	67	95	13	21158-2118	63	2.875	3.751	0.375	73	95	10
21158-1951	63	2.625	3.875	0.375	67	98	10	21158-2120	63	2.875	3.751	0.500	73	95	13
21158-1954	63	2.625	4.003	0.375	67	102	10	21158-2121	63	2.875	3.875	0.375	73	98	10
21158-1956	63	2.625	4.003	0.500	67	102	13	21158-2122	63	2.875	3.875	0.437	73	98	11
21158-1975	63	2.656	3.751	0.375	67	95	10	21158-2123	63	2.875	3.875	0.500	73	98	13
21158-1987	63	2.688	3.372	0.375	68	86	10	21158-2124	63	2.875	4.003	0.375	73	102	10
21158-1990	63	2.687	3.481	0.375	68	88	10	21158-2126	63	2.875	4.003	0.500	73	102	13
21158-1993	63	2.688	3.500	0.375	68	89	10	21158-2127	63	2.875	4.125	0.406	73	105	10
21158-1999	63	2.688	3.623	0.375	68	92	10	21158-2128	63	2.875	4.125	0.469	73	105	12
21158-2001	63	2.688	3.623	0.500	68	92	13	21158-2138	63	2.906	4.003	0.375	74	102	10
21158-2002	63	2.688	3.751	0.375	68	95	10	21158-2141	63	2.906	4.125	0.406	74	105	10
21158-2003	63	2.688	3.751	0.438	68	95	11	21158-2143	63	2.938	3.623	0.375	75	92	10
21158-2004	63	2.688	3.751	0.500	68	95	13	21158-2145	63	2.938	3.623	0.500	75	92	13
21158-2005	63	2.688	3.875	0.375	68	98	10	21158-2146	63	2.938	3.751	0.375	75	95	10
21158-2007	63	2.688	3.875	0.500	68	98	13	21158-2148	63	2.937	3.751	0.500	75	95	13
21158-2008	63	2.688	4.003	0.375	68	102	10	21158-2149	63	2.938	3.875	0.375	75	98	10
21158-2011	63	2.719	3.481	0.375	69	88	10	21158-2151	63	2.937	3.876	0.500	75	98	13
21158-2014	63	2.719	3.500	0.375	69	89	10	21158-2152	63	2.938	4.003	0.375	75	102	10
21158-2017	63	2.719	3.543	0.375	69	90	10	21158-2153	63	2.938	4.003	0.438	75	102	11
21158-2023	63	2.719	3.751	0.375	69	95	10	21158-2154	63	2.938	4.003	0.500	75	102	13
21158-2028	63	2.719	3.875	0.500	69	98	13	21158-2155	63	2.938	4.125	0.406	75	105	10
21158-2031	63	2.719	4.003	0.500	69	102	13	21158-2157	63	2.969	3.751	0.375	75	95	10
21158-2032	63	2.750	3.481	0.375	70	88	10	21158-2160	63	2.969	3.875	0.375	75	98	10
21158-2035	63	2.750	3.500	0.375	70	89	10	21158-2163	63	2.969	4.003	0.375	75	102	10
21158-2036	63	2.750	3.500	0.438	70	89	11	21158-2166	63	2.969	4.125	0.406	75	105	10
21158-2037	63	2.750	3.500	0.500	70	89	13	21158-2168	63	3.000	3.751	0.375	76	95	10
21158-2038	63	2.750	3.543	0.375	70	90	10	21158-2169	63	3.000	3.751	0.438	76	95	11
21158-2039	63	2.750	3.543	0.437	70	90	11	21158-2170	63	3.000	3.751	0.500	76	95	13
21158-2040	63	2.750	3.543	0.500	70	90	13	21158-2171	63	3.000	3.875	0.375	76	98	10
21158-2041	63	2.750	3.623	0.375	70	92	10	21158-2172	63	3.000	3.875	0.438	76	98	11
21158-2043	63	2.750	3.623	0.500	70	92	13	21158-2173	63	3.000	3.875	0.500	76	98	13
21158-2044	63	2.750	3.751	0.375	70	95	10	21158-2174	63	3.000	4.003	0.375	76	102	10
21158-2045	63	2.750	3.751	0.437	70	95	11	21158-2175	63	3.000	4.003	0.438	76	102	11
								21158-2176	63	3.000	4.003	0.500	76	102	13

All dimensions are in inches. Preferred sizes are indicated with **bold** type face.  
 Sizes listed are for standard nitrile elements, except Models 25 and 62 which have PTFE elements. Other material available on inquiry only.



## Oil Seals by Model Number

Product Code	Model	Inches			MM			Product Code	Model	Inches			MM		
		ID	OD	Width	ID	OD	Width			ID	OD	Width	ID	OD	Width
21158-3863	63	0.250	0.750	0.250	6	19	6	21158-6623	63	0.469	1.260	0.313	12	32	8
21158-3864	63	0.250	0.875	0.250	6	22	6	21158-6627	63	2.863	4.724	0.500	73	120	13
21158-3865	63	0.437	1.375	0.313	11	35	8	21158-6643	63	0.563	1.260	0.313	14	32	8
21158-3867	63	0.469	1.375	0.313	12	35	8	21158-6654	63	1.000	2.047	0.375	25	52	10
21158-3869	63	0.563	1.000	0.313	14	25	8	21158-6655	63	1.375	2.047	0.375	35	52	10
21158-3870	63	0.750	1.260	0.406	19	32	10	21158-6656	63	1.969	2.835	0.375	50	72	10
21158-3871	63	1.062	1.984	0.500	27	50	13	21158-6659	63	1.188	1.850	0.375	30	47	10
21158-3872	63	1.125	1.984	0.375	29	50	10	21158-6724	63	1.750	3.125	0.375	44	79	10
21158-3873	63	1.125	1.984	0.437	29	50	11	21158-6725	63	1.750	2.835	0.375	44	72	10
21158-3875	63	1.156	2.441	0.375	29	62	10	21158-6859	63	0.984	1.850	0.375	25	47	10
21158-3876	63	1.188	1.828	0.375	30	46	10	21158-6906	63	1.000	1.851	0.375	25	47	10
21158-3877	63	1.188	2.048	0.375	30	52	10	21158-7126	63	1.688	2.835	0.375	43	72	10
21158-3879	63	1.313	2.875	0.500	33	73	13	21158-7164	63	1.875	2.835	0.375	48	72	10
21158-3880	63	1.500	2.441	0.375	38	62	10	21158-7198	63	0.781	1.850	0.375	20	47	10
21158-3881	63	1.500	2.882	0.375	38	73	10	21158-7218	63	2.156	3.544	0.375	55	90	10
21158-3883	63	1.563	2.875	0.375	40	73	10	21158-7316	63	1.266	2.048	0.375	32	52	10
21158-3885	63	1.750	3.189	0.500	44	81	13	21158-7396	63	1.375	2.000	0.375	35	51	10
21158-3887	63	1.844	2.500	0.375	47	64	10	21158-7415	63	1.969	3.150	0.375	50	80	10
21158-3888	63	1.875	3.149	0.375	48	80	10	21158-7459	63	1.750	2.719	0.359	44	69	9
21158-3892	63	2.000	3.375	0.500	51	86	13	21158-7596	63	2.938	3.938	0.375	75	100	10
21158-3893	63	2.031	2.783	0.375	52	71	10	21158-7650	63	1.125	1.850	0.313	29	47	8
21158-3896	63	2.031	3.150	0.344	52	80	9	21158-7667	63	2.156	2.835	0.375	55	72	10
21158-3897	63	2.063	2.783	0.375	52	71	10	21158-7702	63	2.232	3.543	0.375	57	90	10
21158-3900	63	2.125	2.882	0.375	54	73	10	21158-7727	63	0.188	0.750	0.250	5	19	6
21158-3903	63	2.188	2.882	0.375	56	73	10	21158-7748	63	1.417	2.047	0.375	36	52	10
21158-3904	63	2.187	2.997	0.375	56	76	10	21158-7761	63	1.781	2.441	0.375	45	62	10
21158-4398	63	1.469	2.625	0.375	37	67	10	21158-7767	63	1.625	2.441	0.375	41	62	10
21158-4571	63	2.313	3.246	0.500	59	82	13	21158-7852	63	1.250	2.048	0.375	32	52	10
21158-4584	63	1.375	2.835	0.375	35	72	10	21158-7884	63	1.575	2.441	0.394	40	62	10
21158-4597	63	1.188	2.835	0.375	30	72	10	21158-7914	63	1.156	2.047	0.375	29	52	10
21158-4646	63	2.375	3.350	0.469	60	85	12	21158-7927	63	2.437	3.937	0.375	62	100	10
21158-4687	63	0.984	2.048	0.375	25	52	10	21158-7934	63	2.750	3.938	0.375	70	100	10
21158-4748	63	0.875	1.851	0.375	22	47	10	21158-7937	63	2.844	3.938	0.375	72	100	10
21158-4793	63	0.656	1.378	0.313	17	35	8	21158-7938	63	2.875	3.938	0.375	73	100	10
21158-4802	63	0.969	1.850	0.375	25	47	10	21158-7941	63	3.000	3.938	0.375	76	100	10
21158-4821	63	1.313	2.048	0.375	33	52	10	21158-8007	63	0.375	1.260	0.312	10	32	8
21158-4845	63	2.500	3.938	0.375	64	100	10	21158-8011	63	0.438	1.260	0.313	11	32	8
21158-4849	63	0.875	2.047	0.375	22	52	10	21158-8018	63	0.562	1.182	0.312	14	30	8
21158-4930	63	1.938	2.835	0.375	49	72	10	21158-8021	63	0.594	1.260	0.313	15	32	8
21158-4935	63	0.750	1.850	0.312	19	47	8	21158-8023	63	0.625	1.182	0.313	16	30	8
21158-4965	63	0.781	1.378	0.313	20	35	8	21158-8029	63	0.687	1.260	0.312	17	32	8
21158-5046	63	0.938	2.048	0.375	24	52	10	21158-8033	63	0.750	1.260	0.313	19	32	8
21158-5080	63	2.500	3.671	0.375	64	93	10	21158-8035	63	0.750	1.654	0.313	19	42	8
21158-5398	63	2.625	3.350	0.469	67	85	12	21158-8038	63	0.781	1.654	0.313	20	42	8
21158-5407	63	2.625	3.375	0.375	67	86	10	21158-8048	63	0.875	1.654	0.312	22	42	8
21158-5501	63	1.500	2.875	0.406	38	73	10	21158-8050	63	0.906	1.654	0.313	23	42	8
21158-5502	63	0.875	1.375	0.406	22	35	10	21158-8055	63	0.938	1.850	0.375	24	47	10
21158-5560	63	2.250	3.350	0.469	57	85	12	21158-8062	63	1.062	1.654	0.312	27	42	8
21158-5562	63	1.108	1.850	0.375	28	47	10	21158-8063	63	1.063	1.850	0.375	27	47	10
21158-5704	63	1.250	1.875	0.375	32	48	10	21158-8065	63	1.094	2.047	0.375	28	52	10
21158-5713	63	1.500	2.125	0.437	38	54	11	21158-8066	63	1.125	1.654	0.313	29	42	8
21158-5891	63	1.125	1.851	0.437	29	47	11	21158-8067	63	1.125	2.047	0.375	29	52	10
21158-5937	63	0.969	2.048	0.375	25	52	10	21158-8071	63	1.313	2.441	0.375	33	62	10
21158-5963	63	1.719	2.835	0.375	44	72	10	21158-8072	63	1.344	2.441	0.375	34	62	10
21158-6120	63	0.750	1.851	0.375	19	47	10	21158-8076	63	1.531	2.441	0.375	39	62	10
21158-6300	63	2.563	3.938	0.375	65	100	10	21158-8078	63	1.563	2.835	0.375	40	72	10

All dimensions are in inches. Preferred sizes are indicated with **bold** type face.

Sizes listed are for standard nitrile elements, except Models 25 and 62 which have PTFE elements. Other material available on inquiry only.

## Oil Seals by Model Number

Product Code	Model	Inches			MM			Product Code	Model	Inches			MM		
		ID	OD	Width	ID	OD	Width			ID	OD	Width	ID	OD	Width
21158-8083	63	1.656	2.835	0.375	42	72	10	21159-0160	63	0.781	1.375	0.375	20	35	10
21158-8085	63	1.750	3.150	0.375	44	80	10	21159-0177	63	0.813	1.375	0.313	21	35	8
21158-8086	63	1.781	2.835	0.375	45	72	10	21159-0185	63	0.813	1.750	0.375	21	44	10
21158-8088	63	1.812	2.835	0.375	46	72	10	21159-0213	63	0.875	1.375	0.313	22	35	8
21158-8091	63	1.844	3.150	0.375	47	80	10	21159-0215	63	0.875	1.500	0.312	22	38	8
21158-8097	63	2.000	3.150	0.375	51	80	10	21159-0216	63	0.875	1.500	0.375	22	38	10
21158-8101	63	0.437	1.182	0.312	11	30	8	21159-0220	63	0.875	1.625	0.375	22	41	10
21158-8109	63	0.594	1.378	0.313	15	35	8	21159-0222	63	0.875	1.750	0.438	22	44	11
21158-8111	63	2.000	2.835	0.375	51	72	10	21159-0231	63	0.875	2.062	0.375	22	52	10
21158-8112	63	2.125	2.835	0.375	54	72	10	21159-0255	63	0.938	1.625	0.313	24	41	8
21158-8117	63	2.156	3.347	0.375	55	85	10	21159-0285	63	0.969	2.062	0.375	25	52	10
21158-8258	63	1.875	3.000	0.562	48	76	14	21159-0287	63	1.000	1.500	0.313	25	38	8
21158-8326	63	1.563	2.441	0.438	40	62	11	21159-0292	63	1.000	1.625	0.375	25	41	10
21158-8337	63	0.437	1.378	0.312	11	35	8	21159-0297	63	1.000	1.875	0.375	25	48	10
21158-8342	63	0.625	1.378	0.313	16	35	8	21159-0303	63	1.000	2.062	0.375	25	52	10
21158-8344	63	0.750	1.378	0.312	19	35	8	21159-0304	63	1.000	2.062	0.437	25	52	11
21158-8350	63	2.062	3.150	0.375	52	80	10	21159-0323	63	1.062	1.625	0.312	27	41	8
21158-8353	63	2.125	3.150	0.375	54	80	10	21159-0325	63	1.063	1.750	0.375	27	44	10
21158-8355	63	2.156	3.150	0.375	55	80	10	21159-0351	63	1.125	1.625	0.313	29	41	8
21158-8357	63	2.188	3.150	0.375	56	80	10	21159-0353	63	1.125	1.750	0.375	29	44	10
21158-8359	63	2.219	3.150	0.375	56	80	10	21159-0358	63	1.125	1.875	0.437	29	48	11
21158-8360	63	2.219	3.347	0.375	56	85	10	21159-0361	63	1.125	2.062	0.375	29	52	10
21158-8361	63	2.250	3.150	0.375	57	80	10	21159-0377	63	1.156	2.250	0.375	29	57	10
21158-8362	63	2.250	3.347	0.375	57	85	10	21159-0380	63	1.156	2.375	0.375	29	60	10
21158-8373	63	2.437	3.150	0.375	62	80	10	21159-0383	63	1.188	1.875	0.375	30	48	10
21158-8374	63	2.438	3.347	0.375	62	85	10	21159-0389	63	1.188	2.062	0.375	30	52	10
21158-8377	63	2.531	3.347	0.375	64	85	10	21159-0400	63	1.188	2.375	0.375	30	60	10
21158-8378	63	2.563	3.347	0.375	65	85	10	21159-0403	63	1.219	1.984	0.375	31	50	10
21158-8405	63	1.781	2.438	0.375	45	62	10	21159-0427	63	1.250	2.000	0.375	32	51	10
21158-8484	63	1.719	2.561	0.500	44	65	13	21159-0442	63	1.250	2.375	0.375	32	60	10
21158-8610	63	1.575	2.441	0.375	40	62	10	21159-0481	63	1.312	2.000	0.375	33	51	10
21158-8615	63	1.625	2.562	0.500	41	65	13	21159-0490	63	1.313	2.125	0.375	33	54	10
21158-8904	63	2.281	3.154	0.375	58	80	10	21159-0535	63	1.375	2.062	0.375	35	52	10
21158-9223	63	1.766	2.559	0.375	45	65	10	21159-0541	63	1.375	2.125	0.375	35	54	10
21158-9342	63	1.181	1.850	0.375	30	47	10	21159-0544	63	1.375	2.250	0.375	35	57	10
21158-9407	63	2.156	2.882	0.375	55	73	10	21159-0556	63	1.375	2.500	0.375	35	64	10
21158-9612	63	1.375	2.875	0.375	35	73	10	21159-0559	63	1.375	2.625	0.375	35	67	10
21158-9620	63	1.750	2.441	0.375	44	62	10	21159-0592	63	1.437	2.125	0.375	36	54	10
21158-9633	63	1.813	2.758	0.500	46	70	13	21159-0616	63	1.469	2.250	0.375	37	57	10
21158-9822	63	1.750	2.375	0.313	44	60	8	21159-0643	63	1.500	2.250	0.375	38	57	10
21159-0001	63	0.281	0.750	0.250	7	19	6	21159-0646	63	1.500	2.375	0.375	38	60	10
21159-0014	63	0.375	0.750	0.313	10	19	8	21159-0657	63	1.500	2.500	0.500	38	64	13
21159-0015	63	0.375	0.875	0.250	10	22	6	21159-0717	63	1.563	2.625	0.500	40	67	13
21159-0017	63	0.375	1.000	0.313	10	25	8	21159-0718	63	1.563	2.686	0.375	40	68	10
21159-0021	63	0.375	1.250	0.313	10	32	8	21159-0760	63	1.625	2.375	0.375	41	60	10
21159-0025	63	0.406	0.875	0.250	10	22	6	21159-0762	63	1.625	2.375	0.500	41	60	13
21159-0049	63	0.500	1.000	0.313	13	25	8	21159-0826	63	1.688	2.375	0.375	43	60	10
21159-0051	63	0.500	1.125	0.313	13	29	8	21159-0904	63	1.750	2.500	0.375	44	64	10
21159-0055	63	0.500	1.375	0.313	13	35	8	21159-1006	63	1.844	2.625	0.375	47	67	10
21159-0087	63	0.625	1.125	0.313	16	29	8	21159-1042	63	1.875	2.625	0.375	48	67	10
21159-0088	63	0.625	1.125	0.375	16	29	10	21159-1048	63	1.875	2.750	0.375	48	70	10
21159-0089	63	0.625	1.250	0.313	16	32	8	21159-1057	63	1.875	2.875	0.375	48	73	10
21159-0112	63	0.688	1.250	0.375	17	32	10	21159-1059	63	1.875	2.875	0.500	48	73	13
21159-0144	63	0.750	1.500	0.375	19	38	10	21159-1069	63	1.875	3.125	0.375	48	79	10
21159-0145	63	0.750	1.575	0.313	19	40	8	21159-1114	63	1.938	2.625	0.375	49	67	10
21159-0153	63	0.750	1.875	0.375	19	48	10	21159-1120	63	1.938	2.750	0.375	49	70	10

All dimensions are in inches. Preferred sizes are indicated with **bold** type face.  
 Sizes listed are for standard nitrile elements, except Models 25 and 62 which have PTFE elements. Other material available on inquiry only.

## Oil Seals by Model Number

Product Code	Model	Inches			MM			Product Code	Model	Inches			MM		
		ID	OD	Width	ID	OD	Width			ID	OD	Width	ID	OD	Width
21159-1129	63	1.938	2.875	0.375	49	73	10	21163-0029	63	0.406	1.125	0.312	10	29	8
21159-1130	63	1.938	2.875	0.437	49	73	11	21163-0037	63	0.437	1.000	0.313	11	25	8
21159-1135	63	1.938	3.000	0.375	49	76	10	21163-0067	63	0.563	1.125	0.313	14	29	8
21159-1186	63	2.000	2.686	0.375	51	68	10	21163-0068	63	0.563	1.125	0.375	14	29	10
21159-1360	63	2.156	2.875	0.375	55	73	10	21163-0069	63	0.563	1.250	0.313	14	32	8
21159-1471	63	2.250	2.997	0.375	57	76	10	21163-0078	63	0.594	1.125	0.375	15	29	10
21159-1474	63	2.250	3.000	0.375	57	76	10	21163-0080	63	0.594	1.250	0.375	15	32	10
21159-1480	63	2.250	3.125	0.375	57	79	10	21163-0157	63	0.781	1.250	0.313	20	32	8
21159-1486	63	2.250	3.189	0.375	57	81	10	21163-0159	63	0.781	1.375	0.313	20	35	8
21159-1495	63	2.250	3.350	0.375	57	85	10	21163-0161	63	0.781	1.500	0.313	20	38	8
21159-1496	63	2.250	3.350	0.437	57	85	11	21163-0213	63	0.875	1.375	0.313	22	35	8
21159-1497	63	2.250	3.350	0.500	57	85	13	21163-0215	63	0.875	1.500	0.313	22	38	8
21159-1555	63	2.313	3.000	0.375	59	76	10	21163-0237	63	0.906	1.625	0.313	23	41	8
21159-1639	63	2.375	3.062	0.375	60	78	10	21163-0265	63	0.938	2.000	0.375	24	51	10
21159-1642	63	2.375	3.125	0.375	60	79	10	21163-0289	63	1.000	1.575	0.312	25	40	8
21159-1668	63	2.375	3.500	0.500	60	89	13	21163-0292	63	1.000	1.625	0.375	25	41	10
21159-1810	63	2.500	3.350	0.375	64	85	10	21163-0293	63	1.000	1.750	0.375	25	44	10
21159-1819	63	2.500	3.500	0.375	64	89	10	21163-0297	63	1.000	1.875	0.375	25	48	10
21159-1827	63	2.500	3.623	0.500	64	92	13	21163-0352	63	1.125	1.625	0.375	29	41	10
21159-1831	63	2.500	3.875	0.375	64	98	10	21163-0428	63	1.250	2.000	0.437	32	51	11
21159-1933	63	2.625	3.372	0.375	67	86	10	21163-0436	63	1.250	2.125	0.375	32	54	10
21159-1987	63	2.688	3.372	0.375	68	86	10	21163-0539	63	1.375	2.106	0.437	35	53	11
21159-2008	63	2.688	4.003	0.375	68	102	10	21163-0544	63	1.375	2.250	0.375	35	57	10
21159-2035	63	2.750	3.500	0.375	70	89	10	21163-0643	63	1.500	2.250	0.375	38	57	10
21159-2037	63	2.750	3.500	0.500	70	89	13	21163-0760	63	1.625	2.375	0.375	41	60	10
21159-2077	63	2.813	3.500	0.375	71	89	10	21163-0780	63	1.625	2.750	0.500	41	70	13
21159-2124	63	2.875	4.003	0.375	73	102	10	21163-0906	63	1.750	2.500	0.500	44	64	13
21159-2143	63	2.938	3.623	0.375	75	92	10	21163-0984	63	1.813	2.750	0.500	46	70	13
21159-2146	63	2.938	3.751	0.375	75	95	10	21163-1003	63	1.813	3.125	0.375	46	79	10
21159-2168	63	3.000	3.751	0.375	76	95	10	21163-1006	63	1.844	2.625	0.375	47	67	10
21159-2174	63	3.000	4.003	0.375	76	102	10	21163-1135	63	1.938	3.000	0.375	49	76	10
21159-3863	63	0.250	0.750	0.250	6	19	6	21163-1186	63	2.000	2.686	0.375	51	68	10
21159-3881	63	1.500	2.882	0.375	38	73	10	21163-1474	63	2.250	3.000	0.375	57	76	10
21159-3892	63	2.000	3.375	0.500	51	86	13	21163-1486	63	2.250	3.189	0.375	57	81	10
21159-3904	63	2.187	2.997	0.375	56	76	10	21163-1495	63	2.250	3.350	0.375	57	85	10
21159-4584	63	1.375	2.835	0.375	35	72	10	21163-1504	63	2.250	3.500	0.375	57	89	10
21159-4682	63	2.094	3.189	0.375	53	81	10	21163-1630	63	2.344	3.623	0.375	60	92	10
21159-5310	63	3.000	4.000	0.563	76	102	14	21163-1801	63	2.500	3.188	0.375	64	81	10
21159-6627	63	2.863	4.724	0.500	73	120	13	21163-1819	63	2.500	3.500	0.375	64	89	10
21159-7761	63	1.781	2.441	0.375	45	62	10	21163-1840	63	2.531	3.250	0.375	64	83	10
21159-7934	63	2.750	3.938	0.375	70	100	10	21163-1939	63	2.625	3.500	0.375	67	89	10
21159-8112	63	2.125	2.835	0.375	54	72	10	21163-2118	63	2.875	3.750	0.375	73	95	10
21160-0173	63	0.781	1.984	0.375	20	50	10	21163-2120	63	2.875	3.751	0.500	73	95	13
21160-0215	63	0.875	1.500	0.313	22	38	8	21163-3872	63	1.125	1.984	0.375	29	50	10
21160-0360	63	1.125	2.000	0.438	29	51	11	21163-8029	63	0.688	1.260	0.313	17	32	8
21160-0595	63	1.438	2.250	0.375	37	57	10	21164-0090	63	0.625	1.250	0.375	16	32	10
21160-0645	63	1.500	2.250	0.500	38	57	13	21164-0143	63	0.750	1.500	0.313	19	38	8
21160-1114	63	1.938	2.631	0.375	49	67	10	21164-0159	63	0.781	1.375	0.313	20	35	8
21160-1426	63	2.188	3.372	0.375	56	86	10	21164-1186	63	2.000	2.686	0.375	51	68	10
21160-1495	63	2.250	3.350	0.375	57	85	10	21164-1321	63	2.125	2.875	0.375	54	73	10
21160-1639	63	2.375	3.062	0.375	60	78	10	21164-2118	63	2.875	3.751	0.375	73	95	10
21160-1821	63	2.500	3.500	0.500	64	89	13	21167-0175	63	0.813	1.250	0.313	21	32	8
21160-2044	63	2.750	3.751	0.375	70	95	10	21168-0009	63	0.344	0.750	0.250	9	19	6
21160-5502	63	0.875	1.375	0.406	22	35	10	21168-0013	63	0.375	0.750	0.250	10	19	6
21160-9481	63	2.937	4.125	0.562	75	105	14	21168-0021	63	0.375	1.250	0.313	10	32	8
21163-0007	63	0.313	0.875	0.250	8	22	6	21168-0049	63	0.500	1.000	0.313	13	25	8

All dimensions are in inches. Preferred sizes are indicated with **bold** type face. Sizes listed are for standard nitrile elements, except Models 25 and 62 which have PTFE elements. Other material available on inquiry only.

## Oil Seals by Model Number

Product Code	Model	Inches			MM			Product Code	Model	Inches			MM		
		ID	OD	Width	ID	OD	Width			ID	OD	Width	ID	OD	Width
21168-0052	63	0.500	1.125	0.375	13	29	10	21168-2168	63	3.000	3.751	0.375	76	95	10
21168-0087	63	0.625	1.125	0.312	16	29	8	21168-2174	63	3.000	4.003	0.375	76	102	10
21168-0121	63	0.719	1.250	0.312	18	32	8	21168-2176	63	3.000	4.003	0.500	76	102	13
21168-0139	63	0.750	1.250	0.313	19	32	8	21168-5562	63	1.108	1.850	0.375	28	47	10
21168-0141	63	0.750	1.375	0.313	19	35	8	21168-6627	63	2.863	4.724	0.500	73	120	13
21168-0159	63	0.781	1.375	0.312	20	35	8	21168-7218	63	2.156	3.544	0.375	55	90	10
21168-0165	63	0.781	1.625	0.312	20	41	8	21168-7941	63	3.000	3.938	0.375	76	100	10
21168-0175	63	0.813	1.250	0.313	21	32	8	21168-8362	63	2.250	3.347	0.375	57	85	10
21168-0177	63	0.813	1.375	0.313	21	35	8	21173-0087	63	0.625	1.125	0.313	16	29	8
21168-0213	63	0.875	1.375	0.313	22	35	8	21173-0139	63	0.750	1.250	0.313	19	32	8
21168-0251	63	0.938	1.500	0.313	24	38	8	21173-0293	63	1.000	1.750	0.375	25	44	10
21168-0252	63	0.937	1.500	0.375	24	38	10	21173-0541	63	1.375	2.125	0.375	35	54	10
21168-0278	63	0.969	1.828	0.437	25	46	11	21173-0550	63	1.375	2.437	0.375	35	62	10
21168-0287	63	1.000	1.500	0.313	25	38	8	21173-0643	63	1.500	2.250	0.375	38	57	10
21168-0293	63	1.000	1.750	0.375	25	44	10	21173-0646	63	1.500	2.375	0.375	38	60	10
21168-0397	63	1.188	2.250	0.375	30	57	10	21173-1042	63	1.875	2.625	0.375	48	67	10
21168-0424	63	1.250	1.984	0.437	32	50	11	21173-1204	63	2.000	3.000	0.375	51	76	10
21168-0427	63	1.250	2.000	0.375	32	51	10	21177-0113	63	0.688	1.375	0.313	17	35	8
21168-0442	63	1.250	2.375	0.375	32	60	10	21177-0213	63	0.875	1.375	0.313	22	35	8
21168-0592	63	1.437	2.125	0.375	36	54	10	21177-0337	63	1.094	1.625	0.313	28	41	8
21168-0713	63	1.563	2.500	0.438	40	64	11	21177-0383	63	1.188	1.875	0.375	30	48	10
21168-0717	63	1.563	2.625	0.500	40	67	13	21177-1204	63	2.000	3.000	0.375	51	76	10
21168-0760	63	1.625	2.375	0.375	41	60	10	21177-1555	63	2.313	3.000	0.375	59	76	10
21168-0835	63	1.688	2.500	0.375	43	64	10	21177-1993	63	2.688	3.500	0.375	68	89	10
21168-0843	63	1.688	2.686	0.500	43	68	13	21177-2032	63	2.750	3.481	0.375	70	88	10
21168-0915	63	1.750	2.750	0.500	44	70	13	21177-2168	63	3.000	3.751	0.375	76	95	10
21168-0937	63	1.781	2.500	0.375	45	64	10	21290-0015	63	0.375	0.875	0.250	10	22	6
21168-0969	63	1.781	3.125	0.500	45	79	13	21290-0053	63	0.500	1.250	0.312	13	32	8
21168-1044	63	1.875	2.625	0.500	48	67	13	21290-0213	63	0.875	1.375	0.312	22	35	8
21168-1141	63	1.938	3.125	0.375	49	79	10	21290-0251	63	0.938	1.500	0.313	24	38	8
21168-1189	63	2.000	2.750	0.375	51	70	10	21290-0252	63	0.938	1.500	0.375	24	38	10
21168-1204	63	2.000	3.000	0.375	51	76	10	21290-0287	63	1.000	1.500	0.312	25	38	8
21168-1206	63	2.000	3.000	0.500	51	76	13	21290-0291	63	1.000	1.625	0.313	25	41	8
21168-1258	63	2.063	3.000	0.375	52	76	10	21290-0301	63	1.000	2.000	0.375	25	51	10
21168-1261	63	2.062	3.062	0.375	52	78	10	21290-0353	63	1.125	1.750	0.375	29	44	10
21168-1402	63	2.188	3.000	0.375	56	76	10	21290-0359	63	1.125	2.000	0.375	29	51	10
21168-1474	63	2.250	3.000	0.375	57	76	10	21290-0383	63	1.188	1.875	0.375	30	48	10
21168-1492	63	2.250	3.250	0.375	57	83	10	21290-0389	63	1.188	2.062	0.375	30	52	10
21168-1494	63	2.250	3.250	0.500	57	83	13	21290-0481	63	1.313	2.000	0.375	33	51	10
21168-1573	63	2.313	3.250	0.375	59	83	10	21290-0646	63	1.500	2.375	0.375	38	60	10
21168-1639	63	2.375	3.062	0.375	60	78	10	21290-0648	63	1.500	2.375	0.500	38	60	13
21168-1656	63	2.375	3.250	0.500	60	83	13	21290-0655	63	1.500	2.500	0.375	38	64	10
21168-1735	63	2.438	3.250	0.375	62	83	10	21290-0673	63	1.531	2.375	0.375	39	60	10
21168-1807	63	2.500	3.250	0.375	64	83	10	21290-0700	63	1.563	2.250	0.375	40	57	10
21168-1809	63	2.500	3.250	0.500	64	83	13	21290-0760	63	1.625	2.375	0.375	41	60	10
21168-1821	63	2.500	3.500	0.500	64	89	13	21290-0769	63	1.625	2.500	0.375	41	64	10
21168-1828	63	2.500	3.751	0.375	64	95	10	21290-0778	63	1.625	2.750	0.375	41	70	10
21168-1830	63	2.500	3.751	0.500	64	95	13	21290-0813	63	1.750	2.375	0.375	44	60	10
21168-1886	63	2.563	3.500	0.437	65	89	11	21290-0844	63	1.688	2.750	0.375	43	70	10
21168-1933	63	2.625	3.372	0.375	67	86	10	21290-0853	63	1.688	2.875	0.375	43	73	10
21168-1939	63	2.625	3.500	0.375	67	89	10	21290-0898	63	1.750	2.438	0.375	44	62	10
21168-1947	63	2.625	3.623	0.500	67	92	13	21290-0904	63	1.750	2.500	0.375	44	64	10
21168-1987	63	2.688	3.372	0.375	68	86	10	21290-0907	63	1.750	2.625	0.375	44	67	10
21168-2046	63	2.750	3.750	0.500	70	95	13	21290-0910	63	1.750	2.686	0.375	44	68	10
21168-2115	63	2.875	3.623	0.375	73	92	10	21290-0922	63	1.750	2.875	0.375	44	73	10
21168-2154	63	2.938	4.003	0.500	75	102	13	21290-0997	63	1.813	3.000	0.375	46	76	10

All dimensions are in inches. Preferred sizes are indicated with **bold** type face. Sizes listed are for standard nitrile elements, except Models 25 and 62 which have PTFE elements. Other material available on inquiry only.

## Oil Seals by Model Number

Product Code	Model	Inches			MM			Product Code	Model	Inches			MM		
		ID	OD	Width	ID	OD	Width			ID	OD	Width	ID	OD	Width
21290-1042	63	1.875	2.625	0.375	48	67	10	21431-0556	63	1.375	2.500	0.375	35	64	10
21290-1092	63	1.625	2.250	0.375	41	57	10	21431-0760	63	1.625	2.375	0.375	41	60	10
21290-1120	63	1.938	2.750	0.375	49	70	10	21431-0859	63	1.688	3.000	0.375	43	76	10
21290-1135	63	1.938	3.000	0.375	49	76	10	21431-0940	63	1.781	2.625	0.375	45	67	10
21290-1186	63	2.000	2.686	0.375	51	68	10	21431-8644	63	1.062	1.979	0.375	27	50	10
21290-1198	63	2.000	2.875	0.375	51	73	10	21457-0213	63	0.875	1.375	0.313	22	35	8
21290-1204	63	2.000	3.000	0.375	51	76	10	21457-0285	63	0.969	2.062	0.375	25	52	10
21290-1258	63	2.063	3.000	0.375	52	76	10	21457-0542	63	1.375	2.125	0.437	35	54	11
21290-1345	63	2.125	3.250	0.375	54	83	10	21457-1821	63	2.500	3.500	0.500	64	89	13
21290-1399	63	2.188	2.875	0.375	56	73	10	21457-6859	63	0.984	1.850	0.375	25	47	10
21290-1471	63	2.250	2.997	0.375	57	76	10	21475-0144	63	0.750	1.500	0.375	19	38	10
21290-1492	63	2.250	3.250	0.375	57	83	10	21475-0269	63	0.969	1.500	0.313	25	38	8
21290-1494	63	2.250	3.250	0.500	57	83	13	21475-0293	63	1.000	1.750	0.375	25	44	10
21290-1505	63	2.250	3.500	0.437	57	89	11	21475-0297	63	1.000	1.875	0.375	25	48	10
21290-1555	63	2.313	3.000	0.375	59	76	10	21475-0333	63	1.062	2.000	0.375	27	51	10
21290-1735	63	2.438	3.250	0.375	62	83	10	21475-0357	63	1.125	1.875	0.375	29	48	10
21290-1738	63	2.438	3.350	0.375	62	85	10	21475-0383	63	1.188	1.875	0.375	30	48	10
21290-1747	63	2.438	3.500	0.375	62	89	10	21475-0439	63	1.250	2.250	0.375	32	57	10
21290-1813	63	2.500	3.372	0.375	64	86	10	21475-0445	63	1.250	2.437	0.375	32	62	10
21290-1820	63	2.500	3.500	0.437	64	89	11	21475-0535	63	1.375	2.062	0.375	35	52	10
21290-1888	63	2.563	3.543	0.375	65	90	10	21475-0595	63	1.438	2.250	0.375	37	57	10
21290-1939	63	2.625	3.500	0.375	67	89	10	21475-0643	63	1.500	2.250	0.375	38	57	10
21290-2003	63	2.688	3.751	0.438	68	95	11	21475-0760	63	1.625	2.375	0.375	41	60	10
21290-2035	63	2.750	3.500	0.375	70	89	10	21475-0898	63	1.750	2.437	0.375	44	62	10
21290-2041	63	2.750	3.623	0.375	70	92	10	21475-0904	63	1.750	2.500	0.375	44	64	10
21290-2115	63	2.875	3.623	0.375	73	92	10	21475-1057	63	1.875	2.875	0.375	48	73	10
21290-2174	63	3.000	4.003	0.375	76	102	10	21475-1069	63	1.875	3.125	0.375	48	79	10
21290-2175	63	3.000	4.003	0.437	76	102	11	21475-1204	63	2.000	3.000	0.375	51	76	10
21290-3885	63	1.750	3.189	0.500	44	81	13	21475-1205	63	2.000	3.000	0.437	51	76	11
21290-5306	63	1.000	1.500	0.250	25	38	6	21475-1206	63	2.000	3.000	0.500	51	76	13
21290-5562	63	1.108	1.850	0.375	28	47	10	21475-1642	63	2.375	3.125	0.375	60	79	10
21290-5704	63	1.250	1.875	0.375	32	48	10	21475-1668	63	2.375	3.500	0.500	60	89	13
21290-6658	63	1.375	2.441	0.375	35	62	10	21475-1807	63	2.500	3.250	0.375	64	83	10
21290-7386	63	1.375	2.000	0.375	35	51	10	21475-1819	63	2.500	3.500	0.375	64	89	10
21290-8082	63	1.656	2.441	0.375	42	62	10	21475-1834	63	2.500	4.003	0.375	64	102	10
21290-8117	63	2.156	3.347	0.375	55	85	10	21475-2039	63	2.750	3.543	0.437	70	90	11
21290-9822	63	1.750	2.375	0.313	44	60	8	21475-2146	63	2.938	3.750	0.375	75	95	10
21294-0139	63	0.750	1.250	0.313	19	32	8	21475-2168	63	3.000	3.751	0.375	76	95	10
21294-0424	63	1.250	1.984	0.375	32	50	10	21475-2171	63	3.000	3.875	0.375	76	98	10
21294-1135	63	1.938	3.000	0.375	49	76	10	21475-2174	63	3.000	4.003	0.375	76	102	10
21294-1150	63	1.969	2.686	0.375	50	68	10	21475-3892	63	2.000	3.375	0.500	51	86	13
21294-2168	63	3.000	3.751	0.375	76	95	10	21475-5713	63	1.500	2.125	0.437	38	54	11
21300-0559	63	1.375	2.625	0.375	35	67	10	21475-6659	63	1.188	1.850	0.375	30	47	10
21300-1120	63	1.938	2.750	0.375	49	70	10	21500-0095	63	0.625	1.575	0.313	16	40	8
21300-2035	63	2.750	3.500	0.375	70	89	10	21500-0141	63	0.750	1.375	0.313	19	35	8
21372-0427	63	1.250	2.000	0.375	32	51	10	21500-0192	63	0.813	1.984	0.438	21	50	11
21372-0646	63	1.500	2.375	0.375	38	60	10	21500-0301	63	1.000	2.000	0.375	25	51	10
21372-1204	63	2.000	3.000	0.375	51	76	10	21500-0556	63	1.375	2.500	0.375	35	64	10
21372-1828	63	2.500	3.750	0.375	64	95	10	21500-0742	63	1.594	2.625	0.375	40	67	10
21391-0015	63	0.375	0.875	0.250	10	22	6	21500-1135	63	1.938	3.000	0.375	49	76	10
21391-0646	63	1.500	2.375	0.375	38	60	10	21500-1219	63	2.000	3.246	0.375	51	82	10
21391-1204	63	2.000	3.000	0.375	51	76	10	21500-1672	63	2.375	3.623	0.375	60	92	10
21391-1828	63	2.500	3.750	0.375	64	95	10	21500-1675	63	2.375	3.751	0.375	60	95	10
21430-0287	63	1.000	1.500	0.313	25	38	8	21500-1822	63	2.500	3.543	0.375	64	90	10
21430-0718	63	1.563	2.686	0.375	40	68	10	21500-1828	63	2.500	3.750	0.375	64	95	10
21431-0535	63	1.375	2.062	0.375	35	52	10	21500-1831	63	2.500	3.875	0.375	64	98	10

All dimensions are in inches. Preferred sizes are indicated with **bold** type face.

Sizes listed are for standard nitrile elements, except Models 25 and 62 which have PTFE elements. Other material available on inquiry only.

## Oil Seals by Model Number

Product Code	Model	Inches			MM			Product Code	Model	Inches			MM		
		ID	OD	Width	ID	OD	Width			ID	OD	Width	ID	OD	Width
21500-2152	63	2.938	4.003	0.375	75	102	10	21695-0293	63	1.000	1.750	0.375	25	44	10
21500-2174	63	3.000	4.003	0.375	76	102	10	21695-0297	63	1.000	1.875	0.375	25	48	10
21500-3880	63	1.500	2.441	0.375	38	62	10	21695-0301	63	1.000	2.000	0.375	25	51	10
21500-3881	63	1.500	2.882	0.375	38	73	10	21695-0303	63	1.000	2.062	0.375	25	52	10
21500-3888	63	1.875	3.149	0.375	48	80	10	21695-0310	63	1.000	1.686	0.312	25	43	8
21506-0013	63	0.375	0.750	0.250	10	19	6	21695-0328	63	1.063	1.828	0.438	27	46	11
21506-2077	63	2.813	3.500	0.375	71	89	10	21695-0351	63	1.125	1.625	0.313	29	41	8
21542-0001	63	0.281	0.750	0.250	7	19	6	21695-0353	63	1.125	1.750	0.375	29	44	10
21542-0005	63	0.313	0.750	0.250	8	19	6	21695-0357	63	1.125	1.875	0.375	29	48	10
21542-0015	63	0.375	0.875	0.250	10	22	6	21695-0359	63	1.125	2.000	0.375	29	51	10
21542-0175	63	0.813	1.250	0.313	21	32	8	21695-0361	63	1.125	2.062	0.375	29	52	10
21542-0199	63	0.844	1.625	0.312	21	41	8	21695-0362	63	1.125	2.062	0.437	29	52	11
21542-0541	63	1.375	2.125	0.375	35	54	10	21695-0363	63	1.156	1.875	0.375	29	48	10
21542-0598	63	1.437	2.375	0.375	36	60	10	21695-0374	63	1.156	2.125	0.375	29	54	10
21542-1048	63	1.875	2.750	0.375	48	70	10	21695-0383	63	1.188	1.875	0.375	30	48	10
21542-1129	63	1.938	2.875	0.375	49	73	10	21695-0385	63	1.188	1.984	0.375	30	50	10
21542-1321	63	2.125	2.875	0.375	54	73	10	21695-0387	63	1.188	2.000	0.375	30	51	10
21542-1333	63	2.125	3.125	0.375	54	79	10	21695-0388	63	1.188	2.000	0.438	30	51	11
21542-2035	63	2.750	3.500	0.375	70	89	10	21695-0424	63	1.250	1.984	0.375	32	50	10
21542-3863	63	0.250	0.750	0.250	6	19	6	21695-0427	63	1.250	2.000	0.375	32	51	10
21542-7650	63	1.125	1.850	0.313	29	47	8	21695-0436	63	1.250	2.125	0.375	32	54	10
21618-0035	63	0.438	0.875	0.313	11	22	8	21695-0441	63	1.250	2.250	0.500	32	57	13
21618-0069	63	0.563	1.250	0.313	14	32	8	21695-0478	63	1.312	1.984	0.375	33	50	10
21618-0213	63	0.875	1.375	0.313	22	35	8	21695-0490	63	1.312	2.125	0.375	33	54	10
21618-1189	63	2.000	2.750	0.375	51	70	10	21695-0491	63	1.313	2.125	0.438	33	54	11
21695-0015	63	0.375	0.875	0.250	10	22	6	21695-0493	63	1.313	2.250	0.375	33	57	10
21695-0017	63	0.375	1.000	0.313	10	25	8	21695-0535	63	1.375	2.062	0.375	35	52	10
21695-0021	63	0.375	1.250	0.313	10	32	8	21695-0538	63	1.375	2.106	0.375	35	53	10
21695-0035	63	0.437	0.875	0.313	11	22	8	21695-0541	63	1.375	2.125	0.375	35	54	10
21695-0049	63	0.500	1.000	0.313	13	25	8	21695-0542	63	1.375	2.125	0.437	35	54	11
21695-0067	63	0.563	1.125	0.313	14	29	8	21695-0547	63	1.375	2.375	0.375	35	60	10
21695-0087	63	0.625	1.125	0.313	16	29	8	21695-0550	63	1.375	2.437	0.375	35	62	10
21695-0089	63	0.625	1.250	0.313	16	32	8	21695-0556	63	1.375	2.500	0.375	35	64	10
21695-0091	63	0.625	1.375	0.313	16	35	8	21695-0559	63	1.375	2.625	0.375	35	67	10
21695-0094	63	0.625	1.500	0.375	16	38	10	21695-0565	63	1.406	2.125	0.375	36	54	10
21695-0139	63	0.750	1.250	0.313	19	32	8	21695-0595	63	1.438	2.250	0.375	37	57	10
21695-0143	63	0.750	1.500	0.313	19	38	8	21695-0610	63	1.438	2.625	0.375	37	67	10
21695-0149	63	0.750	1.750	0.375	19	44	10	21695-0643	63	1.500	2.250	0.375	38	57	10
21695-0157	63	0.781	1.250	0.313	20	32	8	21695-0646	63	1.500	2.375	0.375	38	60	10
21695-0159	63	0.781	1.375	0.313	20	35	8	21695-0655	63	1.500	2.500	0.375	38	64	10
21695-0175	63	0.813	1.250	0.313	21	32	8	21695-0664	63	1.500	2.750	0.375	38	70	10
21695-0213	63	0.875	1.375	0.312	22	35	8	21695-0700	63	1.563	2.250	0.375	40	57	10
21695-0215	63	0.875	1.500	0.313	22	38	8	21695-0715	63	1.562	2.625	0.375	40	67	10
21695-0216	63	0.875	1.500	0.375	22	38	10	21695-0721	63	1.563	2.750	0.375	40	70	10
21695-0217	63	0.875	1.575	0.313	22	40	8	21695-0760	63	1.625	2.375	0.375	41	60	10
21695-0221	63	0.875	1.750	0.375	22	44	10	21695-0763	63	1.625	2.437	0.375	41	62	10
21695-0229	63	0.875	2.000	0.375	22	51	10	21695-0769	63	1.625	2.500	0.375	41	64	10
21695-0251	63	0.938	1.500	0.313	24	38	8	21695-0789	63	1.625	2.875	0.500	41	73	13
21695-0271	63	0.969	1.575	0.313	25	40	8	21695-0826	63	1.688	2.375	0.375	43	60	10
21695-0273	63	0.969	1.625	0.313	25	41	8	21695-0835	63	1.688	2.500	0.375	43	64	10
21695-0274	63	0.969	1.625	0.375	25	41	10	21695-0844	63	1.688	2.750	0.375	43	70	10
21695-0278	63	0.969	1.828	0.437	25	46	11	21695-0904	63	1.750	2.500	0.375	44	64	10
21695-0283	63	0.969	2.000	0.375	25	51	10	21695-0907	63	1.750	2.625	0.375	44	67	10
21695-0287	63	1.000	1.500	0.313	25	38	8	21695-0915	63	1.750	2.750	0.500	44	70	13
21695-0291	63	1.000	1.625	0.312	25	41	8	21695-0937	63	1.781	2.500	0.375	45	64	10
21695-0292	63	1.000	1.625	0.375	25	41	10	21695-0971	63	0.406	0.875	0.312	10	22	8

All dimensions are in inches. Preferred sizes are indicated with **bold** type face. Sizes listed are for standard nitrile elements, except Models 25 and 62 which have PTFE elements. Other material available on inquiry only.

## Oil Seals by Model Number

Product Code	Model	Inches			MM			Product Code	Model	Inches			MM		
		ID	OD	Width	ID	OD	Width			ID	OD	Width	ID	OD	Width
21695-0982	63	1.813	2.750	0.375	46	70	10	21695-1821	63	2.500	3.500	0.500	64	89	13
21695-1003	63	1.813	3.125	0.875	46	79	22	21695-1822	63	2.500	3.543	0.375	64	90	10
21695-1012	63	1.844	2.750	0.375	47	70	10	21695-1828	63	2.500	3.751	0.375	64	95	10
21695-1042	63	1.875	2.625	0.375	48	67	10	21695-1830	63	2.500	3.751	0.500	64	95	13
21695-1044	63	1.875	2.625	0.500	48	67	13	21695-1870	63	2.563	3.246	0.375	65	82	10
21695-1051	63	1.875	2.756	0.375	48	70	10	21695-1885	63	2.563	3.500	0.375	65	89	10
21695-1057	63	1.875	2.875	0.375	48	73	10	21695-1894	63	2.563	3.751	0.375	65	95	10
21695-1063	63	1.875	3.000	0.375	48	76	10	21695-1900	63	2.562	4.003	0.375	65	102	10
21695-1076	63	1.875	3.189	0.437	48	81	11	21695-1933	63	2.625	3.372	0.375	67	86	10
21695-1114	63	1.938	2.625	0.375	49	67	10	21695-1939	63	2.625	3.500	0.375	67	89	10
21695-1186	63	2.000	2.686	0.375	51	68	10	21695-1942	63	2.625	3.543	0.375	67	90	10
21695-1189	63	2.000	2.750	0.375	51	70	10	21695-1945	63	2.625	3.623	0.375	67	92	10
21695-1197	63	2.000	2.716	0.375	51	69	10	21695-1948	63	2.625	3.751	0.375	67	95	10
21695-1198	63	2.000	2.875	0.375	51	73	10	21695-1993	63	2.688	3.500	0.375	68	89	10
21695-1200	63	2.000	2.875	0.500	51	73	13	21695-2004	63	2.688	3.751	0.500	68	95	13
21695-1201	63	2.000	2.997	0.375	51	76	10	21695-2008	63	2.688	4.003	0.375	68	102	10
21695-1204	63	2.000	3.000	0.375	51	76	10	21695-2032	63	2.750	3.481	0.375	70	88	10
21695-1207	63	2.000	3.063	0.375	51	78	10	21695-2035	63	2.750	3.500	0.375	70	89	10
21695-1210	63	2.000	3.125	0.375	51	79	10	21695-2044	63	2.750	3.751	0.375	70	95	10
21695-1219	63	2.000	3.246	0.375	51	82	10	21695-2047	63	2.750	3.875	0.375	70	98	10
21695-1258	63	2.063	3.000	0.375	52	76	10	21695-2077	63	2.813	3.500	0.375	71	89	10
21695-1264	63	2.062	3.125	0.375	52	79	10	21695-2086	63	2.813	3.751	0.375	71	95	10
21695-1321	63	2.125	2.875	0.375	54	73	10	21695-2089	63	2.813	3.875	0.375	71	98	10
21695-1322	63	2.125	2.875	0.438	54	73	11	21695-2115	63	2.875	3.623	0.375	73	92	10
21695-1323	63	2.125	2.875	0.500	54	73	13	21695-2118	63	2.875	3.750	0.375	73	95	10
21695-1327	63	2.125	3.000	0.375	54	76	10	21695-2120	63	2.875	3.751	0.500	73	95	13
21695-1333	63	2.125	3.125	0.375	54	79	10	21695-2124	63	2.875	4.003	0.375	73	102	10
21695-1350	63	2.125	3.350	0.500	54	85	13	21695-2146	63	2.938	3.751	0.375	75	95	10
21695-1375	63	2.156	3.147	0.375	55	80	10	21695-2149	63	2.938	3.875	0.375	75	98	10
21695-1420	63	2.188	3.250	0.375	56	83	10	21695-2168	63	3.000	3.751	0.375	76	95	10
21695-1423	63	2.188	3.350	0.375	56	85	10	21695-2171	63	3.000	3.875	0.375	76	98	10
21695-1424	63	2.188	3.350	0.437	56	85	11	21695-2174	63	3.000	4.003	0.375	76	102	10
21695-1471	63	2.250	2.997	0.375	57	76	10	21695-2176	63	3.000	4.003	0.500	76	102	13
21695-1474	63	2.250	3.000	0.375	57	76	10	21695-3863	63	0.250	0.750	0.250	6	19	6
21695-1477	63	2.250	3.062	0.375	57	78	10	21695-3864	63	0.250	0.875	0.250	6	22	6
21695-1480	63	2.250	3.125	0.375	57	79	10	21695-3876	63	1.188	1.828	0.375	30	46	10
21695-1492	63	2.250	3.250	0.375	57	83	10	21695-3880	63	1.500	2.441	0.375	38	62	10
21695-1493	63	2.250	3.250	0.437	57	83	11	21695-3888	63	1.875	3.149	0.375	48	80	10
21695-1573	63	2.313	3.250	0.375	59	83	10	21695-4600	63	1.188	2.441	0.375	30	62	10
21695-1594	63	2.313	3.751	0.375	59	95	10	21695-4935	63	0.750	1.850	0.312	19	47	8
21695-1654	63	2.375	3.250	0.375	60	83	10	21695-5407	63	2.625	3.375	0.375	67	86	10
21695-1657	63	2.375	3.350	0.375	60	85	10	21695-6655	63	1.375	2.047	0.375	35	52	10
21695-1663	63	2.375	3.481	0.375	60	88	10	21695-6658	63	1.375	2.441	0.375	35	62	10
21695-1666	63	2.375	3.500	0.375	60	89	10	21695-7727	63	0.188	0.750	0.250	5	19	6
21695-1678	63	2.375	3.875	0.375	60	98	10	21695-8068	63	1.219	2.047	0.375	31	52	10
21695-1681	63	2.406	3.125	0.375	61	79	10	21695-8378	63	2.563	3.347	0.375	65	85	10
21695-1723	63	2.438	3.125	0.375	62	79	10	21695-9342	63	1.181	1.850	0.375	30	47	10
21695-1735	63	2.437	3.250	0.375	62	83	10	21698-1940	63	2.625	3.500	0.437	67	89	11
21695-1742	63	2.438	3.372	0.438	62	86	11	21755-0160	63	0.781	1.375	0.375	20	35	10
21695-1756	63	2.437	3.751	0.375	62	95	10	21755-0898	63	1.750	2.437	0.375	44	62	10
21695-1801	63	2.500	3.189	0.375	64	81	10	21793-0645	63	1.500	2.250	0.500	38	57	13
21695-1804	63	2.500	3.250	0.375	64	83	10	21793-2077	63	2.813	3.500	0.375	71	89	10
21695-1807	63	2.500	3.250	0.375	64	83	10	21795-0049	63	0.500	1.000	0.313	13	25	8
21695-1809	63	2.500	3.250	0.500	64	83	13	21795-0089	63	0.625	1.250	0.313	16	32	8
21695-1810	63	2.500	3.350	0.375	64	85	10	21795-0215	63	0.875	1.500	0.312	22	38	8
21695-1819	63	2.500	3.500	0.375	64	89	10	21795-0293	63	1.000	1.750	0.375	25	44	10

All dimensions are in inches. Preferred sizes are indicated with **bold** type face.

Sizes listed are for standard nitrile elements, except Models 25 and 62 which have PTFE elements. Other material available on inquiry only.

## Oil Seals by Model Number

Product Code	Model	Inches			MM			Product Code	Model	Inches			MM		
		ID	OD	Width	ID	OD	Width			ID	OD	Width	ID	OD	Width
21795-0394	63	1.188	2.125	0.375	30	54	10	21221-4180	64-L	16.000	18.000	0.813	406	457	21
21795-0439	63	1.250	2.250	0.375	32	57	10	21221-4188	64-L	17.000	18.500	0.688	432	470	17
21795-0643	63	1.500	2.250	0.375	38	57	10	21221-4254	64-L	21.250	23.250	0.875	540	591	22
21795-1054	63	1.875	2.783	0.375	48	71	10	21221-4283	64-L	23.000	24.500	0.750	584	622	19
21795-1129	63	1.938	2.875	0.375	49	73	10	21221-4325	64-L	26.000	28.000	0.875	660	711	22
21795-1474	63	2.250	3.000	0.375	57	76	10	21221-4343	64-L	28.000	29.500	0.750	711	749	19
21795-1494	63	2.250	3.250	0.500	57	83	13	21221-4352	64-L	29.500	31.500	0.875	749	800	22
21795-1544	63	2.500	3.375	0.437	64	86	11	21221-4448	64-L	38.000	40.000	0.875	965	1016	22
21795-1555	63	2.313	3.000	0.375	59	76	10	21221-4533	64-L	26.500	28.000	0.750	673	711	19
21795-1807	63	2.500	3.250	0.375	64	83	10	21221-4612	64	12.000	13.500	0.687	305	343	17
21795-1808	63	2.500	3.250	0.438	64	83	11	21222-4011	64	10.500	12.000	0.687	267	305	17
21795-1948	63	2.625	3.750	0.375	67	95	10	21222-4163	64-L	15.500	17.500	0.812	394	445	21
21795-2035	63	2.750	3.500	0.375	70	89	10	21222-4170	64-L	15.750	17.250	0.688	400	438	17
21795-2146	63	2.938	3.751	0.375	75	95	10	21222-4180	64-L	16.000	18.000	0.812	406	457	21
21795-6659	63	1.188	1.850	0.375	30	47	10	21222-4216	64-L	18.500	20.500	0.875	470	521	22
21805-0261	63	0.938	1.875	0.375	24	48	10	21222-4253	64-L	21.000	23.000	0.875	533	584	22
21805-0333	63	1.063	2.000	0.375	27	51	10	21222-4284	64-L	23.000	25.000	0.875	584	635	22
21805-1438	63	2.219	3.000	0.375	56	76	10	21222-4294	64-L	24.000	26.000	0.875	610	660	22
21805-2077	63	2.813	3.500	0.375	71	89	10	21222-4399	64-L	34.000	36.000	0.875	864	914	22
21811-0287	63	1.000	1.500	0.313	25	38	8	21222-4468	64-L	40.500	42.500	0.875	1029	1080	22
21893-0269	63	0.969	1.500	0.313	25	38	8	21222-4612	64	12.000	13.500	0.688	305	343	17
21893-0427	63	1.250	2.000	0.375	32	51	10	21222-4632	64-L	32.000	34.000	0.875	813	864	22
21893-0643	63	1.500	2.250	0.375	38	57	10	21222-4639	64-L	48.250	50.250	0.875	1226	1276	22
21893-0646	63	1.500	2.375	0.375	38	60	10	21222-7300	64-L	40.500	43.000	0.875	1029	1092	22
21893-1204	63	2.000	3.000	0.375	51	76	10	21222-7538	64-L	39.750	42.250	0.875	1010	1073	22
21893-5713	63	1.500	2.125	0.437	38	54	11	21222-8031	64-L	27.000	29.500	0.875	686	749	22
21919-0143	63	0.750	1.500	0.313	19	38	8	21223-9079	64-L	35.438	38.583	0.875	900	980	22
21919-0147	63	0.750	1.625	0.313	19	41	8	21224-4365	64-L	30.500	32.500	0.875	775	826	22
21919-0287	63	1.000	1.500	0.313	25	38	8	21225-4099	64-L	13.000	15.000	0.813	330	381	21
21919-0383	63	1.188	1.875	0.375	30	48	10	21225-4206	64-L	18.000	19.500	0.688	457	495	17
21919-0643	63	1.500	2.250	0.375	38	57	10	21225-4639	64-L	48.250	50.250	0.875	1226	1276	22
21919-0769	63	1.625	2.500	0.375	41	64	10	21225-7300	64-L	40.500	43.000	0.875	1029	1092	22
21919-0840	63	1.687	2.625	0.500	43	67	13	21226-3992	64	10.000	11.500	0.687	254	292	17
21919-0843	63	1.687	2.686	0.500	43	68	13	21226-4163	64-L	15.500	17.500	0.813	394	445	21
21919-1399	63	2.188	2.875	0.375	56	73	10	21226-4188	64-L	17.000	18.500	0.688	432	470	17
21919-1475	63	2.250	3.000	0.438	57	76	11	21226-4218	64-L	19.000	20.500	0.750	483	521	19
21919-1729	63	2.438	3.189	0.375	62	81	10	21226-4294	64-L	24.000	26.000	0.875	610	660	22
21919-1987	63	2.688	3.372	0.375	68	86	10	21226-4619	64-L	20.500	22.000	0.750	521	559	19
21919-2038	63	2.750	3.543	0.375	70	90	10	21226-4639	64-L	48.250	50.250	0.875	1226	1276	22
21919-2118	63	2.875	3.751	0.375	73	95	10	21226-9079	64-L	35.438	38.583	0.875	900	980	22
21919-2146	63	2.938	3.751	0.375	75	95	10	21227-4283	64-L	23.000	24.500	0.750	584	622	19
21919-2176	63	3.000	4.003	0.500	76	102	13	21227-4612	64	12.000	13.500	0.688	305	343	17
21919-3876	63	1.188	1.828	0.375	30	46	10	21238-0569	64-L	21.500	23.750	0.875	546	603	22
21928-1189	63	2.000	2.750	0.375	51	70	10	21238-0586	64-L	43.504	45.669	0.984	1105	1160	25
21216-4081	64-L	12.625	14.125	0.688	321	359	17	21238-1073	64-L	39.370	41.339	0.866	1000	1050	22
21216-4305	64-L	24.500	26.500	0.875	622	673	22	21238-1299	64	6.125	7.625	0.688	156	194	17
21216-4350	64-L	39.000	41.500	0.875	991	1054	22	21238-1451	64-L	24.803	26.378	0.748	630	670	19
21217-4011	64	10.500	12.000	0.688	267	305	17	21238-1692	64	9.750	11.125	0.563	248	283	14
21217-4365	64-L	30.500	32.500	0.875	775	826	22	21238-1705	64	8.500	9.750	0.563	216	248	14
21221-3774	64-L	25.000	27.000	0.875	635	686	22	21238-1914	64-L	51.250	53.300	0.875	1302	1354	22
21221-4036	64	11.000	13.000	0.813	279	330	21	21238-1929	64-L	16.535	18.504	0.866	420	470	22
21221-4075	64-L	12.250	14.250	0.812	311	362	21	21238-2394	64-L	22.047	24.016	0.875	560	610	22
21221-4093	64-L	13.000	14.500	0.688	330	368	17	21238-2576	64-L	22.375	24.375	0.875	568	619	22
21221-4101	64-L	13.250	14.750	0.688	337	375	17	21238-2622	64-L	14.875	16.875	0.938	378	429	24
21221-4118	64-L	14.250	15.750	0.687	362	400	17	21238-2812	64	8.750	10.875	0.812	222	276	21
21221-4156	64-L	15.000	17.000	0.813	381	432	21	21238-3135	64	11.000	12.250	0.563	279	311	14

All dimensions are in inches. Preferred sizes are indicated with **bold** type face. Sizes listed are for standard nitrile elements, except Models 25 and 62 which have PTFE elements. Other material available on inquiry only.



## Oil Seals by Model Number

Product Code	Model	Inches			MM			Product Code	Model	Inches			MM		
		ID	OD	Width	ID	OD	Width			ID	OD	Width	ID	OD	Width
21238-3145	64	9.500	10.750	0.563	241	273	14	21238-4057	64	11.500	13.000	0.688	292	330	17
21238-3702	64-L	12.000	14.750	0.813	305	375	21	21238-4063	64	11.500	13.500	0.813	292	343	21
21238-3716	64-L	12.625	14.500	0.687	321	368	17	21238-4064	64	11.750	13.250	0.688	298	337	17
21238-3744	64-L	16.750	18.250	0.687	425	464	17	21238-4071	64-L	12.000	14.000	0.750	305	356	19
21238-3750	64-L	17.000	19.500	0.812	432	495	21	21238-4072	64-L	12.000	14.000	0.813	305	356	21
21238-3752	64-L	18.000	20.500	0.875	457	521	22	21238-4075	64-L	12.250	14.250	0.813	311	362	21
21238-3757	64-L	18.250	19.750	0.688	464	502	17	21238-4076	64	12.375	13.875	0.688	314	352	17
21238-3763	64-L	22.000	24.250	0.875	559	616	22	21238-4079	64-L	12.500	14.000	0.688	318	356	17
21238-3764	64-L	22.250	24.250	0.875	565	616	22	21238-4081	64-L	12.625	14.125	0.688	321	359	17
21238-3768	64-L	18.500	20.000	0.687	470	508	17	21238-4082	64-L	12.500	14.500	0.750	318	368	19
21238-3774	64-L	25.000	27.000	0.875	635	686	22	21238-4083	64-L	12.500	14.500	0.813	318	368	21
21238-3779	64-L	19.500	21.000	0.750	495	533	19	21238-4084	64-L	12.500	15.000	0.813	318	381	21
21238-3790	64-L	20.000	22.500	0.875	508	572	22	21238-4089	64-L	12.756	14.252	0.709	324	362	18
21238-3797	64-L	30.000	32.500	1.000	762	826	25	21238-4093	64-L	13.000	14.500	0.688	330	368	17
21238-3835	64-L	35.000	37.000	0.875	889	940	22	21238-4096	64-L	13.000	14.875	0.688	330	378	17
21238-3836	64-L	35.000	37.500	0.875	889	953	22	21238-4097	64-L	12.375	14.375	0.688	314	365	17
21238-3837	64-L	35.000	38.000	0.875	889	965	22	21238-4099	64-L	13.000	15.000	0.813	330	381	21
21238-3855	64-L	14.250	16.500	0.813	362	419	21	21238-4101	64-L	13.250	14.750	0.688	337	375	17
21238-3856	64-L	14.625	16.250	0.688	371	413	17	21238-4108	64-L	13.813	16.000	0.812	351	406	21
21238-3860	64-L	14.875	17.000	0.813	378	432	21	21238-4110	64-L	13.875	16.000	0.813	352	406	21
21238-3878	64-L	28.000	30.500	0.875	711	775	22	21238-4112	64-L	13.938	16.000	0.687	354	406	17
21238-3921	64	8.000	9.500	0.688	203	241	17	21238-4118	64-L	14.250	15.750	0.688	362	400	17
21238-3933	64	8.375	9.875	0.688	213	251	17	21238-4119	64-L	13.750	16.000	0.813	349	406	21
21238-3938	64	8.500	10.500	0.813	216	267	21	21238-4121	64-L	13.504	15.000	0.709	343	381	18
21238-3939	64	8.625	10.125	0.688	219	257	17	21238-4123	64-L	13.500	15.750	0.813	343	400	21
21238-3946	64	8.750	10.250	0.688	222	260	17	21238-4124	64-L	13.500	15.250	0.750	343	387	19
21238-3952	64	8.750	10.750	0.813	222	273	21	21238-4128	64-L	13.500	15.500	0.813	343	394	21
21238-3953	64	8.875	10.875	0.813	225	276	21	21238-4129	64-L	13.750	15.750	0.813	349	400	21
21238-3954	64	9.000	10.500	0.688	229	267	17	21238-4130	64-L	13.938	15.437	0.688	354	392	17
21238-3955	64	9.000	11.000	0.813	229	279	21	21238-4131	64-L	14.000	15.500	0.688	356	394	17
21238-3957	64	9.125	10.625	0.688	232	270	17	21238-4134	64-L	14.000	15.750	0.750	356	400	19
21238-3962	64	9.125	11.125	0.813	232	283	21	21238-4135	64-L	14.000	16.000	0.813	356	406	21
21238-3963	64	9.250	10.750	0.688	235	273	17	21238-4140	64-L	14.250	16.250	0.813	362	413	21
21238-3981	64	9.500	11.250	0.750	241	286	19	21238-4142	64-L	14.500	16.000	0.688	368	406	17
21238-3984	64	9.500	11.500	0.813	241	292	21	21238-4145	64-L	14.500	16.500	0.813	368	419	21
21238-3985	64	9.750	11.250	0.688	248	286	17	21238-4147	64-L	14.750	16.250	0.688	375	413	17
21238-3992	64	10.000	11.500	0.688	254	292	17	21238-4151	64-L	15.000	16.500	0.688	381	419	17
21238-3994	64	10.000	11.750	0.750	254	298	19	21238-4156	64-L	15.000	17.000	0.813	381	432	21
21238-3997	64	10.000	12.000	0.813	254	305	21	21238-4158	64-L	15.313	16.875	0.688	389	429	17
21238-3998	64	10.000	12.000	0.875	254	305	22	21238-4159	64-L	15.375	17.375	0.813	391	441	21
21238-3999	64	10.125	11.625	0.688	257	295	17	21238-4163	64-L	15.500	17.500	0.813	394	445	21
21238-4004	64	10.250	11.750	0.688	260	298	17	21238-4169	64-L	15.748	17.717	0.709	400	450	18
21238-4011	64	10.500	12.000	0.688	267	305	17	21238-4170	64-L	15.750	17.250	0.688	400	438	17
21238-4015	64	10.250	12.500	0.813	260	318	21	21238-4171	64-L	15.750	17.500	0.688	400	445	17
21238-4017	64	10.500	12.500	0.813	267	318	21	21238-4172	64-L	15.750	18.000	0.813	400	457	21
21238-4023	64	10.750	12.250	0.688	273	311	17	21238-4173	64-L	16.000	17.625	0.688	406	448	17
21238-4026	64	10.750	13.250	0.812	273	337	21	21238-4176	64-L	15.875	17.875	0.813	403	454	21
21238-4027	64	10.875	12.375	0.688	276	314	17	21238-4177	64-L	16.000	17.500	0.688	406	445	17
21238-4028	64	10.875	12.500	0.688	276	318	17	21238-4180	64-L	16.000	18.000	0.813	406	457	21
21238-4031	64	10.750	12.750	0.813	273	324	21	21238-4181	64-L	16.250	17.750	0.688	413	451	17
21238-4036	64	11.000	13.000	0.813	279	330	21	21238-4183	64-L	16.500	19.000	0.813	419	483	21
21238-4039	64	11.024	13.386	0.813	280	340	21	21238-4186	64-L	16.500	18.500	0.813	419	470	21
21238-4047	64	11.250	13.250	0.813	286	337	21	21238-4188	64-L	17.000	18.500	0.688	432	470	17
21238-4052	64	11.375	13.375	0.813	289	340	21	21238-4190	64-L	17.000	19.000	0.813	432	483	21
21238-4055	64-L	12.250	14.000	0.688	311	356	17	21238-4191	64-L	17.000	19.250	0.813	432	489	21
21238-4056	64-L	12.375	14.000	0.688	314	356	17	21238-4194	64-L	17.500	19.000	0.688	445	483	17

All dimensions are in inches. Preferred sizes are indicated with **bold** type face.

Sizes listed are for standard nitrile elements, except Models 25 and 62 which have PTFE elements. Other material available on inquiry only.

## Oil Seals by Model Number

Product Code	Model	Inches			MM			Product Code	Model	Inches			MM		
		ID	OD	Width	ID	OD	Width			ID	OD	Width	ID	OD	Width
21238-4197	64-L	17.500	19.750	0.812	445	502	21	21238-4305	64-L	24.500	26.500	0.875	622	673	22
21238-4198	64-L	17.500	19.500	0.688	445	495	17	21238-4306	64-L	25.988	27.625	0.750	660	702	19
21238-4199	64-L	17.625	19.250	0.688	448	489	17	21238-4308	64-L	25.000	26.500	0.750	635	673	19
21238-4200	64-L	17.750	19.750	0.813	451	502	21	21238-4309	64-L	25.000	27.000	1.000	635	686	25
21238-4204	64-L	17.875	19.875	0.813	454	505	21	21238-4311	64-L	25.188	26.875	0.750	640	683	19
21238-4206	64-L	18.000	19.500	0.688	457	495	17	21238-4313	64-L	26.500	28.500	0.875	673	724	22
21238-4209	64-L	18.000	20.000	0.750	457	508	19	21238-4315	64-L	27.500	29.000	0.750	699	737	19
21238-4210	64-L	18.000	20.000	0.875	457	508	22	21238-4316	64-L	28.000	29.813	0.750	711	757	19
21238-4213	64-L	18.375	19.875	0.688	467	505	17	21238-4318	64-L	25.500	27.500	0.875	648	699	22
21238-4215	64-L	18.375	20.000	0.750	467	508	19	21238-4320	64-L	28.000	30.250	0.813	711	768	21
21238-4216	64-L	18.500	20.500	0.875	470	521	22	21238-4322	64-L	29.500	32.250	0.875	749	819	22
21238-4218	64-L	19.000	20.500	0.750	483	521	19	21238-4323	64-L	30.000	32.250	0.875	762	819	22
21238-4219	64-L	19.000	21.000	0.875	483	533	22	21238-4325	64-L	26.000	28.000	0.875	660	711	22
21238-4221	64-L	19.500	21.500	0.875	495	546	22	21238-4326	64-L	33.000	35.250	0.875	838	895	22
21238-4228	64-L	19.750	21.750	0.875	502	552	22	21238-4329	64-L	26.125	27.625	0.750	664	702	19
21238-4232	64	12.205	13.780	0.689	310	350	18	21238-4330	64-L	26.125	28.125	0.875	664	714	22
21238-4233	64-L	19.938	21.688	0.625	506	551	16	21238-4333	64-L	27.000	29.000	0.875	686	737	22
21238-4235	64-L	20.000	21.500	0.750	508	546	19	21238-4338	64-L	34.500	37.500	0.875	876	953	22
21238-4236	64-L	20.000	21.750	0.750	508	552	19	21238-4339	64-L	27.500	29.500	0.875	699	749	22
21238-4237	64-L	20.000	22.000	0.875	508	559	22	21238-4341	64-L	27.875	29.813	0.875	708	757	22
21238-4239	64-L	20.250	21.750	0.750	514	552	19	21238-4343	64-L	28.000	29.500	0.750	711	749	19
21238-4240	64-L	20.250	22.250	0.875	514	565	22	21238-4344	64-L	28.000	30.000	0.875	711	762	22
21238-4242	64-L	20.438	22.500	0.813	519	572	21	21238-4346	64-L	28.500	30.500	0.875	724	775	22
21238-4244	64-L	20.866	22.835	0.827	530	580	21	21238-4347	64-L	29.000	30.500	0.750	737	775	19
21238-4245	64-L	20.500	22.250	0.813	521	565	21	21238-4348	64-L	29.000	31.000	0.875	737	787	22
21238-4246	64-L	20.500	22.500	0.875	521	572	22	21238-4350	64-L	39.000	41.500	0.875	991	1054	22
21238-4248	64-L	20.750	22.750	0.875	527	578	22	21238-4352	64-L	29.500	31.500	0.875	749	800	22
21238-4250	64-L	20.875	22.875	0.875	530	581	22	21238-4356	64-L	30.000	31.500	0.750	762	800	19
21238-4251	64-L	21.000	23.250	0.812	533	591	21	21238-4357	64-L	30.000	32.000	0.875	762	813	22
21238-4253	64-L	21.000	23.000	0.875	533	584	22	21238-4358	64-L	30.000	32.500	0.875	762	826	22
21238-4254	64-L	21.250	23.250	0.875	540	591	22	21238-4361	64-L	30.313	32.375	0.875	770	822	22
21238-4257	64-L	21.500	23.250	0.750	546	591	19	21238-4365	64-L	30.500	32.500	0.875	775	826	22
21238-4259	64-L	21.500	23.500	0.875	546	597	22	21238-4367	64-L	31.000	33.000	0.875	787	838	22
21238-4260	64-L	21.750	24.500	0.875	552	622	22	21238-4371	64-L	32.125	34.125	0.875	816	867	22
21238-4261	64-L	21.625	23.375	0.750	549	594	19	21238-4373	64-L	32.313	34.500	0.875	821	876	22
21238-4263	64-L	21.625	23.625	0.875	549	600	22	21238-4377	64-L	32.500	34.500	0.875	826	876	22
21238-4265	64-L	21.750	23.750	0.875	552	603	22	21238-4381	64-L	33.000	34.500	0.750	838	876	19
21238-4269	64-L	22.000	23.500	0.750	559	597	19	21238-4382	64-L	33.000	35.000	0.875	838	889	22
21238-4270	64-L	22.000	24.000	0.875	559	610	22	21238-4389	64-L	33.500	35.500	0.875	851	902	22
21238-4277	64-L	23.000	25.375	0.875	584	645	22	21238-4405	64-L	34.500	36.500	0.875	876	927	22
21238-4279	64-L	22.500	24.500	0.875	572	622	22	21238-4416	64-L	35.250	37.250	0.875	895	946	22
21238-4281	64-L	22.750	24.750	0.875	578	629	22	21238-4417	64-L	35.375	37.375	0.875	899	949	22
21238-4283	64-L	23.000	24.500	0.750	584	622	19	21238-4421	64-L	36.000	38.000	0.875	914	965	22
21238-4284	64-L	23.000	25.000	0.875	584	635	22	21238-4429	64-L	36.500	38.000	0.750	927	965	19
21238-4285	64-L	23.000	25.500	0.875	584	648	22	21238-4430	64-L	36.500	38.500	0.875	927	978	22
21238-4288	64-L	23.500	25.500	0.875	597	648	22	21238-4432	64-L	36.750	38.750	0.875	933	984	22
21238-4290	64-L	23.563	25.250	0.750	599	641	19	21238-4434	64-L	37.000	39.000	0.875	940	991	22
21238-4291	64-L	23.563	25.375	0.750	599	645	19	21238-4436	64-L	37.250	39.250	0.875	946	997	22
21238-4292	64-L	23.625	26.000	0.875	600	660	22	21238-4438	64-L	37.500	39.500	0.875	953	1003	22
21238-4293	64-L	23.875	26.000	0.875	606	660	22	21238-4448	64-L	38.000	40.000	0.875	965	1016	22
21238-4294	64-L	24.000	26.000	0.875	610	660	22	21238-4456	64-L	38.750	40.750	0.875	984	1035	22
21238-4297	64-L	24.000	26.500	0.875	610	673	22	21238-4465	64-L	39.000	41.000	0.875	991	1041	22
21238-4300	64-L	25.500	27.000	0.875	648	686	22	21238-4467	64-L	40.000	42.000	0.875	1016	1067	22
21238-4301	64-L	24.250	26.250	0.875	616	667	22	21238-4468	64-L	40.500	42.500	0.875	1029	1080	22
21238-4302	64-L	24.437	26.000	0.750	621	660	19	21238-4473	64-L	42.500	45.000	0.875	1080	1143	22
21238-4304	64-L	24.438	26.437	0.750	621	671	19	21238-4475	64-L	44.000	46.500	0.875	1118	1181	22

All dimensions are in inches. Preferred sizes are indicated with **bold** type face.  
 Sizes listed are for standard nitrile elements, except Models 25 and 62 which have PTFE elements. Other material available on inquiry only.

## Oil Seals by Model Number

Product Code	Model	Inches			MM			Product Code	Model	Inches			MM		
		ID	OD	Width	ID	OD	Width			ID	OD	Width	ID	OD	Width
21238-4476	64-L	15.250	17.250	0.813	387	438	21	21238-5991	64-L	14.000	15.750	0.688	356	400	17
21238-4499	64	8.250	10.250	0.813	210	260	21	21238-5992	64-L	15.313	17.313	0.688	389	440	17
21238-4527	64	11.250	12.750	0.688	286	324	17	21238-5994	64-L	25.188	26.938	0.750	640	684	19
21238-4529	64-L	13.750	15.250	0.688	349	387	17	21238-5995	64-L	16.000	18.500	0.813	406	470	21
21238-4531	64-L	13.750	15.500	0.750	349	394	19	21238-6034	64	11.000	13.000	0.688	279	330	17
21238-4533	64-L	26.500	28.000	0.750	673	711	19	21238-6152	64-L	33.000	34.688	0.750	838	881	19
21238-4534	64-L	28.500	31.000	0.875	724	787	22	21238-6239	64-L	23.750	25.250	1.000	603	641	25
21238-4537	64-L	29.000	32.000	0.875	737	813	22	21238-6269	64-L	42.500	45.500	0.875	1080	1156	22
21238-4538	64-L	29.500	32.000	0.875	749	813	22	21238-6287	64-L	20.500	22.750	0.875	521	578	22
21238-4539	64-L	29.500	32.500	0.875	749	826	22	21238-6293	64-L	24.000	26.250	0.875	610	667	22
21238-4541	64-L	31.000	34.000	0.875	787	864	22	21238-6294	64-L	13.250	15.250	0.688	337	387	17
21238-4542	64-L	32.750	34.250	0.750	832	870	19	21238-6384	64	8.500	9.750	0.625	216	248	16
21238-4544	64-L	33.000	35.500	0.875	838	902	22	21238-6417	64-L	20.875	23.228	0.875	530	590	22
21238-4550	64-L	33.500	36.000	0.875	851	914	22	21238-6421	64-L	25.000	27.250	0.875	635	692	22
21238-4552	64-L	33.504	36.417	0.906	851	925	23	21238-6493	64-L	21.500	23.625	0.875	546	600	22
21238-4563	64-L	44.500	46.000	0.750	1130	1168	19	21238-6740	64-L	18.375	20.375	0.813	467	518	21
21238-4570	64-L	38.750	41.000	0.875	984	1041	22	21238-6747	64-L	51.250	53.250	0.875	1302	1353	22
21238-4578	64-L	46.500	48.500	0.875	1181	1232	22	21238-6787	64-L	33.000	34.625	0.750	838	879	19
21238-4610	64	9.375	11.375	0.813	238	289	21	21238-6843	64-L	22.750	25.000	0.875	578	635	22
21238-4611	64	11.000	12.500	0.688	279	318	17	21238-6850	64-L	17.625	19.625	0.688	448	498	17
21238-4612	64	12.000	13.500	0.688	305	343	17	21238-6874	64-L	15.750	17.750	0.688	400	451	17
21238-4613	64	12.250	13.750	0.688	311	349	17	21238-6910	64-L	23.250	25.250	0.813	591	641	21
21238-4615	64-L	15.250	16.750	0.688	387	425	17	21238-6967	64-L	17.250	18.750	0.750	438	476	19
21238-4617	64-L	19.250	20.750	0.750	489	527	19	21238-6998	64-L	25.750	27.250	0.750	654	692	19
21238-4619	64-L	20.500	22.000	0.750	521	559	19	21238-7065	64-L	53.150	55.669	0.866	1350	1414	22
21238-4621	64-L	21.750	23.250	0.750	552	591	19	21238-7087	64-L	44.000	46.000	0.875	1118	1168	22
21238-4623	64-L	24.000	25.500	0.750	610	648	19	21238-7103	64-L	18.375	19.938	0.688	467	506	17
21238-4626	64-L	27.250	29.250	0.875	692	743	22	21238-7169	64-L	13.250	15.000	0.687	337	381	17
21238-4628	64-L	28.750	30.750	0.875	730	781	22	21238-7189	64-L	43.000	45.500	0.875	1092	1156	22
21238-4631	64-L	31.250	32.750	0.750	794	832	19	21238-7266	64-L	22.047	24.016	0.787	560	610	20
21238-4632	64-L	32.000	34.000	0.875	813	864	22	21238-7281	64-L	18.898	20.472	0.787	480	520	20
21238-4635	64-L	41.500	43.500	0.875	1054	1105	22	21238-7300	64-L	40.500	43.000	0.875	1029	1092	22
21238-4637	64-L	43.500	45.500	0.875	1105	1156	22	21238-7391	64	11.024	12.598	0.787	280	320	20
21238-4638	64-L	43.750	45.750	0.875	1111	1162	22	21238-7393	64-L	21.260	23.228	0.984	540	590	25
21238-4639	64-L	48.250	50.250	0.875	1226	1276	22	21238-7400	64-L	19.750	22.125	0.875	502	562	22
21238-4779	64-L	13.250	15.250	0.813	337	387	21	21238-7407	64-L	21.500	23.500	0.813	546	597	21
21238-4794	64-L	26.000	28.500	0.875	660	724	22	21238-7428	64-L	36.750	39.250	0.875	933	997	22
21238-4856	64-L	62.000	64.000	0.813	1575	1626	21	21238-7535	64-L	14.000	16.500	0.813	356	419	21
21238-4906	64-L	30.250	32.500	0.875	768	826	22	21238-7537	64-L	32.125	34.625	0.875	816	879	22
21238-4979	64-L	64.409	66.929	0.866	1636	1700	22	21238-7538	64-L	39.750	42.250	0.875	1010	1073	22
21238-5000	64-L	30.000	31.616	0.750	762	803	19	21238-7652	64-L	12.750	14.750	0.688	324	375	17
21238-5001	64-L	27.625	29.625	0.750	702	752	19	21238-7734	64-L	13.250	14.875	0.688	337	378	17
21238-5016	64-L	31.750	33.750	0.875	806	857	22	21238-7769	64	10.630	12.126	0.688	270	308	17
21238-5033	64-L	31.250	33.250	0.750	794	845	19	21238-8031	64-L	27.000	29.500	0.875	686	749	22
21238-5054	64-L	17.500	19.250	0.688	445	489	17	21238-8198	64-L	50.000	52.000	0.875	1270	1321	22
21238-5077	64-L	16.000	18.000	0.875	406	457	22	21238-8217	64-L	16.250	18.000	0.688	413	457	17
21238-5259	64-L	21.000	22.500	0.750	533	572	19	21238-8231	64-L	20.250	22.245	0.875	514	565	22
21238-5404	64-L	12.874	15.000	0.827	327	381	21	21238-8317	64-L	46.850	48.819	0.875	1190	1240	22
21238-5421	64-L	23.000	24.750	0.750	584	629	19	21238-8407	64-L	32.000	34.500	0.875	813	876	22
21238-5482	64-L	59.000	61.000	0.875	1499	1549	22	21238-8453	64	8.500	10.000	0.688	216	254	17
21238-5485	64-L	19.250	21.250	0.750	489	540	19	21238-8557	64-L	63.327	65.748	0.787	1609	1670	20
21238-5555	64-L	42.500	44.250	0.875	1080	1124	22	21238-8577	64-L	30.500	33.000	0.875	775	838	22
21238-5838	64-L	12.000	14.000	0.688	305	356	17	21238-8594	64-L	54.331	56.693	0.984	1380	1440	25
21238-5921	64-L	26.000	27.625	0.750	660	702	19	21238-8599	64-L	40.000	42.500	1.000	1016	1080	25
21238-5989	64	10.125	11.750	0.688	257	298	17	21238-8624	64-L	23.622	25.197	0.787	600	640	20
21238-5990	64-L	14.750	16.500	0.688	375	419	17	21238-8628	64-L	41.875	43.500	1.000	1064	1105	25

All dimensions are in inches. Preferred sizes are indicated with **bold** type face.

Sizes listed are for standard nitrile elements, except Models 25 and 62 which have PTFE elements. Other material available on inquiry only.

## Oil Seals by Model Number

Product Code	Model	Inches			MM			Product Code	Model	Inches			MM		
		ID	OD	Width	ID	OD	Width			ID	OD	Width	ID	OD	Width
21238-8675	64-L	21.750	24.250	0.875	552	616	22	21243-4190	64-L	17.000	19.000	0.813	432	483	21
21238-8765	64	9.134	10.625	0.687	232	270	17	21243-4194	64-L	17.500	19.000	0.688	445	483	17
21238-8778	64	11.250	13.250	0.688	286	337	17	21243-4206	64-L	18.000	19.500	0.688	457	495	17
21238-8903	64-L	45.000	46.625	1.000	1143	1184	25	21243-4210	64-L	18.000	20.000	0.875	457	508	22
21238-9010	64-L	74.409	76.929	0.984	1890	1954	25	21243-4216	64-L	18.500	20.500	0.875	470	521	22
21238-9082	64-L	22.000	24.250	0.812	559	616	21	21243-4218	64-L	19.000	20.500	0.750	483	521	19
21238-9084	64-L	17.750	20.078	0.875	451	510	22	21243-4221	64-L	19.500	21.500	0.875	495	546	22
21238-9176	64	7.875	9.375	0.688	200	238	17	21243-4228	64-L	19.750	21.750	0.875	502	552	22
21238-9271	64-L	15.750	17.313	0.688	400	440	17	21243-4235	64-L	20.000	21.500	0.750	508	546	19
21238-9280	64-L	14.188	16.732	0.813	360	425	21	21243-4246	64-L	20.500	22.500	0.875	521	572	22
21238-9411	64-L	37.500	39.000	0.750	953	991	19	21243-4253	64-L	21.000	23.000	0.875	533	584	22
21238-9425	64	9.750	11.750	0.688	248	298	17	21243-4254	64-L	21.250	23.250	0.875	540	591	22
21238-9772	64-L	21.000	23.500	0.875	533	597	22	21243-4259	64-L	21.500	23.500	0.875	546	597	22
21238-9863	64-L	16.500	18.000	0.688	419	457	17	21243-4265	64-L	21.750	23.750	0.875	552	603	22
21242-2191	64-L	33.000	34.629	0.750	838	880	19	21243-4270	64-L	22.000	24.000	0.875	559	610	22
21242-3921	64	8.000	9.500	0.688	203	241	17	21243-4279	64-L	22.500	24.500	0.875	572	622	22
21242-4151	64-L	15.000	16.500	0.688	381	419	17	21243-4281	64-L	22.750	24.750	0.875	578	629	22
21242-4294	64-L	24.000	26.000	0.875	610	660	22	21243-4284	64-L	23.000	25.000	0.875	584	635	22
21242-4381	64-L	33.000	34.500	0.750	838	876	19	21243-4288	64-L	23.500	25.500	0.875	597	648	22
21242-4405	64-L	34.500	36.500	0.875	876	927	22	21243-4290	64-L	23.563	25.250	0.750	599	641	19
21242-9863	64-L	16.500	18.000	0.688	419	457	17	21243-4294	64-L	24.000	26.000	0.875	610	660	22
21243-2736	64	8.625	10.250	0.688	219	260	17	21243-4305	64-L	24.500	26.500	0.875	622	673	22
21243-3921	64	8.000	9.500	0.688	203	241	17	21243-4330	64-L	26.125	28.125	0.875	664	714	22
21243-3939	64	8.625	10.125	0.688	219	257	17	21243-4333	64-L	27.000	29.000	0.875	686	737	22
21243-3946	64	8.750	10.250	0.688	222	260	17	21243-4344	64-L	28.000	30.000	0.875	711	762	22
21243-3954	64	9.000	10.500	0.688	229	267	17	21243-4352	64-L	29.500	31.500	0.875	749	800	22
21243-3984	64	9.500	11.500	0.813	241	292	21	21243-4405	64-L	34.500	36.500	0.875	876	927	22
21243-3992	64	10.000	11.500	0.688	254	292	17	21243-4499	64	8.250	10.250	0.813	210	260	21
21243-4011	64	10.500	12.000	0.688	267	305	17	21243-4527	64	11.250	12.750	0.688	286	324	17
21243-4015	64	10.250	12.500	0.812	260	318	21	21243-4533	64-L	26.500	28.000	0.750	673	711	19
21243-4031	64	10.750	12.750	0.813	273	324	21	21243-4612	64	12.000	13.500	0.688	305	343	17
21243-4036	64	11.000	13.000	0.813	279	330	21	21243-4613	64	12.250	13.750	0.688	311	349	17
21243-4052	64	11.375	13.375	0.813	289	340	21	21243-4615	64-L	15.250	16.750	0.688	387	425	17
21243-4057	64	11.500	13.000	0.688	292	330	17	21243-4619	64-L	20.500	22.000	0.750	521	559	19
21243-4063	64	11.500	13.500	0.813	292	343	21	21243-4621	64-L	21.750	23.250	0.750	552	591	19
21243-4071	64-L	12.000	14.000	0.750	305	356	19	21243-5989	64	10.125	11.750	0.688	257	298	17
21243-4075	64-L	12.250	14.250	0.813	311	362	21	21243-5990	64-L	14.750	16.500	0.688	375	419	17
21243-4076	64	12.375	13.875	0.688	314	352	17	21243-5991	64-L	14.000	15.750	0.688	356	400	17
21243-4079	64-L	12.500	14.000	0.688	318	356	17	21243-5992	64-L	15.313	17.313	0.688	389	440	17
21243-4093	64-L	13.000	14.500	0.688	330	368	17	21243-7391	64	11.024	12.598	0.787	280	320	20
21243-4099	64-L	13.000	15.000	0.813	330	381	21	21243-7407	64-L	21.500	23.500	0.812	546	597	21
21243-4101	64-L	13.250	14.750	0.688	337	375	17	21243-8217	64-L	16.250	18.000	0.688	413	457	17
21243-4121	64-L	13.500	15.000	0.688	343	381	17	21245-4343	64-L	28.000	29.500	0.750	711	749	19
21243-4123	64-L	13.500	15.750	0.813	343	400	21	21245-4382	64-L	33.000	35.000	0.875	838	889	22
21243-4128	64-L	13.500	15.500	0.813	343	394	21	21247-1451	64-L	24.803	26.378	0.750	630	670	19
21243-4129	64-L	13.750	15.750	0.813	349	400	21	21247-2616	64-L	18.500	21.000	0.875	470	533	22
21243-4130	64-L	13.938	15.437	0.688	354	392	17	21247-3135	64	11.000	12.250	0.563	279	311	14
21243-4135	64-L	14.000	16.000	0.813	356	406	21	21247-3393	64-L	18.375	20.079	0.750	467	510	19
21243-4140	64-L	14.250	16.250	0.813	362	413	21	21247-3757	64-L	18.250	19.750	0.687	464	502	17
21243-4142	64-L	14.500	16.000	0.688	368	406	17	21247-3774	64-L	25.000	27.000	0.875	635	686	22
21243-4145	64-L	14.500	16.500	0.813	368	419	21	21247-3837	64-L	35.000	38.000	0.875	889	965	22
21243-4151	64-L	15.000	16.500	0.688	381	419	17	21247-3921	64	8.000	9.500	0.688	203	241	17
21243-4170	64-L	15.750	17.250	0.688	400	438	17	21247-3946	64	8.750	10.250	0.688	222	260	17
21243-4183	64-L	16.500	19.000	0.813	419	483	21	21247-3954	64	9.000	10.500	0.688	229	267	17
21243-4186	64-L	16.500	18.500	0.813	419	470	21	21247-3955	64	9.000	11.000	0.813	229	279	21
21243-4188	64-L	17.000	18.500	0.688	432	470	17	21247-3963	64	9.250	10.750	0.688	235	273	17

All dimensions are in inches. Preferred sizes are indicated with **bold** type face. Sizes listed are for standard nitrile elements, except Models 25 and 62 which have PTFE elements. Other material available on inquiry only.

## Oil Seals by Model Number

Product Code	Model	Inches			MM			Product Code	Model	Inches			MM		
		ID	OD	Width	ID	OD	Width			ID	OD	Width	ID	OD	Width
21247-3984	64	9.500	11.500	0.813	241	292	21	21247-4333	64-L	27.000	29.000	0.875	686	737	22
21247-3985	64	9.750	11.250	0.688	248	286	17	21247-4339	64-L	27.500	29.500	0.875	699	749	22
21247-3997	64	10.000	12.000	0.813	254	305	21	21247-4343	64-L	28.000	29.500	0.750	711	749	19
21247-4011	64	10.500	12.000	0.688	267	305	17	21247-4344	64-L	28.000	30.000	0.875	711	762	22
21247-4017	64	10.500	12.500	0.813	267	318	21	21247-4352	64-L	29.500	31.500	0.875	749	800	22
21247-4057	64	11.500	13.000	0.688	292	330	17	21247-4356	64-L	30.000	31.500	0.750	762	800	19
21247-4063	64	11.500	13.500	0.812	292	343	21	21247-4357	64-L	30.000	32.000	0.875	762	813	22
21247-4075	64-L	12.250	14.250	0.813	311	362	21	21247-4365	64-L	30.500	32.500	0.875	775	826	22
21247-4076	64	12.375	13.875	0.688	314	352	17	21247-4367	64-L	31.000	33.000	0.875	787	838	22
21247-4083	64-L	12.500	14.500	0.813	318	368	21	21247-4381	64-L	33.000	34.500	0.750	838	876	19
21247-4093	64-L	13.000	14.500	0.688	330	368	17	21247-4382	64-L	33.000	35.000	0.875	838	889	22
21247-4101	64-L	13.250	14.750	0.688	337	375	17	21247-4389	64-L	33.500	35.500	0.875	851	902	22
21247-4121	64-L	13.500	15.000	0.687	343	381	17	21247-4405	64-L	34.500	36.500	0.875	876	927	22
21247-4128	64-L	13.500	15.500	0.812	343	394	21	21247-4438	64-L	37.500	39.500	0.875	953	1003	22
21247-4129	64-L	13.750	15.750	0.813	349	400	21	21247-4448	64-L	38.000	40.000	0.875	965	1016	22
21247-4135	64-L	14.000	16.000	0.813	356	406	21	21247-4467	64-L	40.000	42.000	0.875	1016	1067	22
21247-4140	64-L	14.250	16.250	0.813	362	413	21	21247-4468	64-L	40.500	42.500	0.875	1029	1080	22
21247-4142	64-L	14.500	16.000	0.688	368	406	17	21247-4473	64-L	42.500	45.000	0.875	1080	1143	22
21247-4145	64-L	14.500	16.500	0.812	368	419	21	21247-4499	64	8.250	10.250	0.813	210	260	21
21247-4147	64-L	14.750	16.250	0.688	375	413	17	21247-4527	64	11.250	12.750	0.688	286	324	17
21247-4151	64-L	15.000	16.500	0.688	381	419	17	21247-4533	64-L	26.500	28.000	0.750	673	711	19
21247-4163	64-L	15.500	17.500	0.813	394	445	21	21247-4550	64-L	33.500	36.000	0.875	851	914	22
21247-4170	64-L	15.750	17.250	0.688	400	438	17	21247-4563	64-L	44.500	46.000	0.750	1130	1168	19
21247-4180	64-L	16.000	18.000	0.813	406	457	21	21247-4611	64	11.000	12.500	0.688	279	318	17
21247-4186	64-L	16.500	18.500	0.813	419	470	21	21247-4612	64	12.000	13.500	0.688	305	343	17
21247-4188	64-L	17.000	18.500	0.688	432	470	17	21247-4613	64	12.250	13.750	0.687	311	349	17
21247-4194	64-L	17.500	19.000	0.688	445	483	17	21247-4615	64-L	15.250	16.750	0.688	387	425	17
21247-4199	64-L	17.625	19.250	0.688	448	489	17	21247-4619	64-L	20.500	22.000	0.750	521	559	19
21247-4206	64-L	18.000	19.500	0.688	457	495	17	21247-4626	64-L	27.250	29.250	0.875	692	743	22
21247-4210	64-L	18.000	20.000	0.875	457	508	22	21247-4632	64-L	32.000	34.000	0.875	813	864	22
21247-4213	64-L	18.375	19.875	0.688	467	505	17	21247-4856	64-L	62.000	64.000	0.813	1575	1626	21
21247-4216	64-L	18.500	20.500	0.875	470	521	22	21247-4906	64-L	30.250	32.500	0.875	768	826	22
21247-4218	64-L	19.000	20.500	0.750	483	521	19	21247-5077	64-L	16.000	18.000	0.875	406	457	22
21247-4221	64-L	19.500	21.500	0.875	495	546	22	21247-5485	64-L	19.250	21.250	0.750	489	540	19
21247-4233	64-L	19.938	21.688	0.625	506	551	16	21247-5921	64-L	26.000	27.625	0.875	660	702	22
21247-4235	64-L	20.000	21.500	0.750	508	546	19	21247-5990	64-L	14.750	16.500	0.688	375	419	17
21247-4239	64-L	20.250	21.750	0.750	514	552	19	21247-6417	64-L	20.875	23.228	0.875	530	590	22
21247-4246	64-L	20.500	22.500	0.875	521	572	22	21247-6747	64-L	51.250	53.250	0.875	1302	1353	22
21247-4253	64-L	21.000	23.000	0.875	533	584	22	21247-6787	64-L	33.000	34.625	0.750	838	879	19
21247-4254	64-L	21.250	23.250	0.875	540	591	22	21247-6967	64-L	17.250	18.750	0.750	438	476	19
21247-4259	64-L	21.500	23.500	0.875	546	597	22	21247-7391	64	11.024	12.598	0.787	280	320	20
21247-4270	64-L	22.000	24.000	0.875	559	610	22	21247-7407	64-L	21.500	23.500	0.813	546	597	21
21247-4279	64-L	22.500	24.500	0.875	572	622	22	21247-8134	64	6.875	8.125	0.562	175	206	14
21247-4281	64-L	22.750	24.750	0.875	578	629	22	21247-8577	64-L	30.500	33.000	0.875	775	838	22
21247-4283	64-L	23.000	24.500	0.750	584	622	19	21247-8624	64-L	23.622	25.197	0.787	600	640	20
21247-4285	64-L	23.000	25.500	0.875	584	648	22	21247-9863	64-L	16.500	18.000	0.688	419	457	17
21247-4291	64-L	23.563	25.375	0.750	599	645	19	21255-4063	64	11.500	13.500	0.813	292	343	21
21247-4292	64-L	23.625	26.000	0.875	600	660	22	21255-4093	64-L	13.000	14.500	0.688	330	368	17
21247-4294	64-L	24.000	26.000	0.875	610	660	22	21255-4186	64-L	16.500	18.500	0.813	419	470	21
21247-4301	64-L	24.250	26.250	0.875	616	667	22	21255-4253	64-L	21.000	23.000	0.875	533	584	22
21247-4305	64-L	24.500	26.500	0.875	622	673	22	21255-4330	64-L	26.125	28.125	0.875	664	714	22
21247-4306	64-L	25.988	27.625	0.750	660	702	19	21255-4613	64	12.250	13.750	0.688	311	349	17
21247-4313	64-L	26.500	28.500	0.875	673	724	22	21259-4343	64-L	28.000	29.500	0.750	711	749	19
21247-4325	64-L	26.000	28.000	0.875	660	711	22	21259-4615	64-L	15.250	16.750	0.688	387	425	17
21247-4329	64-L	26.125	27.625	0.750	664	702	19	21385-3984	64	9.500	11.500	0.813	241	292	21
21247-4330	64-L	26.125	28.125	0.875	664	714	22	21444-4011	64	10.500	12.000	0.688	267	305	17

All dimensions are in inches. Preferred sizes are indicated with **bold** type face.

Sizes listed are for standard nitrile elements, except Models 25 and 62 which have PTFE elements. Other material available on inquiry only.

## Oil Seals by Model Number

Product Code	Model	Inches			MM			Product Code	Model	Inches			MM		
		ID	OD	Width	ID	OD	Width			ID	OD	Width	ID	OD	Width
21450-3835	64-L	35.000	37.000	0.875	889	940	22	21840-4151	64-L	15.000	16.500	0.687	381	419	17
21450-4198	64-L	17.500	19.500	0.688	445	495	17	21840-4170	64-L	15.750	17.250	0.688	400	438	17
21450-4318	64-L	25.500	27.500	0.875	648	699	22	21840-4186	64-L	16.500	18.500	0.813	419	470	21
21450-4635	64-L	41.500	43.500	0.875	1054	1105	22	21840-4194	64-L	17.500	19.000	0.688	445	483	17
21450-8407	64-L	32.000	34.500	0.875	813	876	22	21840-4246	64-L	20.500	22.500	0.875	521	572	22
21769-1073	64-L	39.338	41.338	0.875	999	1050	22	21840-4264	64-L	21.625	23.625	1.000	549	600	25
21769-4430	64-L	36.500	38.500	0.875	927	978	22	21840-4269	64-L	22.000	23.500	0.750	559	597	19
21769-4639	64-L	48.250	50.250	0.875	1226	1276	22	21840-4283	64-L	23.000	24.500	0.750	584	622	19
21769-5001	64-L	27.625	29.625	0.750	702	752	19	21840-4288	64-L	23.500	25.500	0.875	597	648	22
21773-1073	64-L	39.338	41.338	0.875	999	1050	22	21840-4308	64-L	25.000	26.500	0.750	635	673	19
21773-3764	64-L	22.250	24.250	0.875	565	616	22	21840-4344	64-L	28.000	30.000	0.875	711	762	22
21773-3921	64	8.000	9.500	0.688	203	241	17	21840-4405	64-L	34.500	36.500	0.875	876	927	22
21773-3946	64	8.750	10.250	0.688	222	260	17	21840-4416	64-L	35.250	37.250	0.875	895	946	22
21773-4064	64	11.750	13.250	0.688	298	337	17	21840-4434	64-L	37.000	39.000	0.875	940	991	22
21773-4075	64-L	12.250	14.250	0.813	311	362	21	21840-4632	64-L	32.000	34.000	0.875	813	864	22
21773-4099	64-L	13.000	15.000	0.813	330	381	21	21840-5990	64-L	14.750	16.500	0.688	375	419	17
21773-4101	64-L	13.250	14.750	0.688	337	375	17	21840-6239	64-L	23.750	25.250	1.000	603	641	25
21773-4118	64-L	14.250	15.750	0.688	362	400	17	21852-1299	64	6.125	7.625	0.688	156	194	17
21773-4135	64-L	14.000	16.000	0.813	356	406	21	21852-1964	64-L	40.500	43.020	0.875	1029	1093	22
21773-4145	64-L	14.500	16.500	0.813	368	419	21	21852-2317	64-L	16.000	18.125	0.875	406	460	22
21773-4163	64-L	15.500	17.500	0.813	394	445	21	21852-2622	64-L	14.875	16.875	0.938	378	429	24
21773-4170	64-L	15.750	17.250	0.688	400	438	17	21852-3701	64	12.000	13.750	0.688	305	349	17
21773-4180	64-L	16.000	18.000	0.813	406	457	21	21852-3716	64-L	12.625	14.500	0.687	321	368	17
21773-4186	64-L	16.500	18.500	0.813	419	470	21	21852-3763	64-L	22.000	24.250	0.875	559	616	22
21773-4188	64-L	17.000	18.500	0.688	432	470	17	21852-3764	64-L	22.250	24.250	0.875	565	616	22
21773-4206	64-L	18.000	19.500	0.688	457	495	17	21852-3774	64-L	25.000	27.000	0.875	635	686	22
21773-4216	64-L	18.500	20.500	0.875	470	521	22	21852-3836	64-L	35.000	37.500	0.875	889	953	22
21773-4218	64-L	19.000	20.500	0.750	483	521	19	21852-3837	64-L	35.000	38.000	0.875	889	965	22
21773-4253	64-L	21.000	23.000	0.875	533	584	22	21852-3921	64	8.000	9.500	0.688	203	241	17
21773-4265	64-L	21.750	23.750	0.875	552	603	22	21852-3939	64	8.625	10.125	0.688	219	257	17
21773-4281	64-L	22.750	24.750	0.875	578	629	22	21852-3946	64	8.750	10.250	0.688	222	260	17
21773-4294	64-L	24.000	26.000	0.875	610	660	22	21852-3953	64	8.875	10.875	0.813	225	276	21
21773-4343	64-L	28.000	29.500	0.750	711	749	19	21852-3954	64	9.000	10.500	0.688	229	267	17
21773-4344	64-L	28.000	30.000	0.875	711	762	22	21852-3955	64	9.000	11.000	0.813	229	279	21
21773-4346	64-L	28.500	30.500	0.875	724	775	22	21852-3957	64	9.125	10.625	0.687	232	270	17
21773-4430	64-L	36.500	38.500	0.875	927	978	22	21852-3963	64	9.250	10.750	0.688	235	273	17
21773-4448	64-L	38.000	40.000	0.875	965	1016	22	21852-3984	64	9.500	11.500	0.813	241	292	21
21773-4468	64-L	40.500	42.500	0.875	1029	1080	22	21852-3992	64	10.000	11.500	0.688	254	292	17
21773-4533	64-L	26.500	28.000	0.750	673	711	19	21852-3997	64	10.000	12.000	0.813	254	305	21
21773-4612	64	12.000	13.500	0.688	305	343	17	21852-3999	64	10.125	11.625	0.688	257	295	17
21773-4613	64	12.250	13.750	0.688	311	349	17	21852-4009	64	10.250	12.250	0.813	260	311	21
21773-4619	64-L	20.500	22.000	0.750	521	559	19	21852-4011	64	10.500	12.000	0.688	267	305	17
21773-4635	64-L	41.500	43.500	0.875	1054	1105	22	21852-4017	64	10.500	12.500	0.813	267	318	21
21773-4639	64-L	48.250	50.250	0.875	1226	1276	22	21852-4036	64	11.000	13.000	0.813	279	330	21
21773-5989	64	10.125	11.750	0.688	257	298	17	21852-4057	64	11.500	13.000	0.688	292	330	17
21773-5991	64-L	14.000	15.750	0.688	356	400	17	21852-4063	64	11.500	13.500	0.813	292	343	21
21773-7300	64-L	40.500	43.000	0.875	1029	1092	22	21852-4064	64	11.750	13.250	0.688	298	337	17
21773-7400	64-L	19.750	22.125	0.875	502	562	22	21852-4072	64-L	12.000	14.000	0.812	305	356	21
21773-7407	64-L	21.500	23.500	0.813	546	597	21	21852-4075	64-L	12.250	14.250	0.813	311	362	21
21773-8792	64-L	16.535	18.504	0.688	420	470	17	21852-4076	64	12.375	13.875	0.688	314	352	17
21773-9079	64-L	35.438	38.583	0.875	900	980	22	21852-4081	64-L	12.625	14.125	0.688	321	359	17
21840-3962	64	9.125	11.125	0.812	232	283	21	21852-4083	64-L	12.500	14.500	0.813	318	368	21
21840-3984	64	9.500	11.500	0.813	241	292	21	21852-4084	64-L	12.500	15.000	0.813	318	381	21
21840-4052	64	11.375	13.375	0.813	289	340	21	21852-4089	64-L	12.750	14.250	0.688	324	362	17
21840-4093	64-L	13.000	14.500	0.688	330	368	17	21852-4093	64-L	13.000	14.500	0.688	330	368	17
21840-4129	64-L	13.750	15.750	0.813	349	400	21	21852-4099	64-L	13.000	15.000	0.812	330	381	21

All dimensions are in inches. Preferred sizes are indicated with **bold** type face. Sizes listed are for standard nitrile elements, except Models 25 and 62 which have PTFE elements. Other material available on inquiry only.

## Oil Seals by Model Number

Product Code	Model	Inches			MM			Product Code	Model	Inches			MM		
		ID	OD	Width	ID	OD	Width			ID	OD	Width	ID	OD	Width
21852-4101	64-L	13.250	14.750	0.688	337	375	17	21852-4305	64-L	24.500	26.500	0.875	622	673	22
21852-4121	64-L	13.500	15.000	0.688	343	381	17	21852-4306	64-L	25.988	27.625	0.750	660	702	19
21852-4128	64-L	13.500	15.500	0.813	343	394	21	21852-4308	64-L	25.000	26.500	0.750	635	673	19
21852-4129	64-L	13.750	15.750	0.813	349	400	21	21852-4311	64-L	25.188	26.875	0.750	640	683	19
21852-4131	64-L	14.000	15.500	0.688	356	394	17	21852-4318	64-L	25.500	27.500	0.875	648	699	22
21852-4135	64-L	14.000	16.000	0.813	356	406	21	21852-4325	64-L	26.000	28.000	0.875	660	711	22
21852-4140	64-L	14.250	16.250	0.813	362	413	21	21852-4330	64-L	26.125	28.125	0.875	664	714	22
21852-4142	64-L	14.500	16.000	0.688	368	406	17	21852-4333	64-L	27.000	29.000	0.875	686	737	22
21852-4145	64-L	14.500	16.500	0.813	368	419	21	21852-4339	64-L	27.500	29.500	0.875	699	749	22
21852-4147	64-L	14.750	16.250	0.688	375	413	17	21852-4343	64-L	28.000	29.500	0.750	711	749	19
21852-4151	64-L	15.000	16.500	0.688	381	419	17	21852-4344	64-L	28.000	30.000	0.875	711	762	22
21852-4156	64-L	15.000	17.000	0.813	381	432	21	21852-4346	64-L	28.500	30.500	0.875	724	775	22
21852-4163	64-L	15.500	17.500	0.813	394	445	21	21852-4352	64-L	29.500	31.500	0.875	749	800	22
21852-4170	64-L	15.750	17.250	0.688	400	438	17	21852-4357	64-L	30.000	32.000	0.875	762	813	22
21852-4177	64-L	16.000	17.500	0.688	406	445	17	21852-4358	64-L	30.000	32.500	0.875	762	826	22
21852-4180	64-L	16.000	18.000	0.813	406	457	21	21852-4365	64-L	30.500	32.500	0.875	775	826	22
21852-4181	64-L	16.250	17.750	0.688	413	451	17	21852-4367	64-L	31.000	33.000	0.875	787	838	22
21852-4186	64-L	16.500	18.500	0.813	419	470	21	21852-4377	64-L	32.500	34.500	0.875	826	876	22
21852-4188	64-L	17.000	18.500	0.688	432	470	17	21852-4381	64-L	33.000	34.500	0.750	838	876	19
21852-4190	64-L	17.000	19.000	0.813	432	483	21	21852-4382	64-L	33.000	35.000	0.875	838	889	22
21852-4194	64-L	17.500	19.000	0.688	445	483	17	21852-4399	64-L	34.000	36.000	0.875	864	914	22
21852-4198	64-L	17.500	19.500	0.688	445	495	17	21852-4405	64-L	34.500	36.500	0.875	876	927	22
21852-4199	64-L	17.625	19.250	0.688	448	489	17	21852-4416	64-L	35.250	37.250	0.875	895	946	22
21852-4206	64-L	18.000	19.500	0.688	457	495	17	21852-4421	64-L	36.000	38.000	0.875	914	965	22
21852-4210	64-L	18.000	20.000	0.875	457	508	22	21852-4432	64-L	36.750	38.750	0.875	933	984	22
21852-4213	64-L	18.375	19.875	0.688	467	505	17	21852-4438	64-L	37.500	39.500	0.875	953	1003	22
21852-4215	64-L	18.375	20.000	0.750	467	508	19	21852-4448	64-L	38.000	40.000	0.875	965	1016	22
21852-4216	64-L	18.500	20.500	0.875	470	521	22	21852-4473	64-L	42.500	45.000	0.875	1080	1143	22
21852-4218	64-L	19.000	20.500	0.750	483	521	19	21852-4475	64-L	44.000	46.500	0.875	1118	1181	22
21852-4219	64-L	19.000	21.000	0.875	483	533	22	21852-4499	64	8.250	10.250	0.813	210	260	21
21852-4221	64-L	19.500	21.500	0.875	495	546	22	21852-4527	64	11.250	12.750	0.688	286	324	17
21852-4228	64-L	19.750	21.750	0.875	502	552	22	21852-4533	64-L	26.500	28.000	0.750	673	711	19
21852-4233	64-L	19.938	21.688	0.625	506	551	16	21852-4538	64-L	29.500	32.000	0.875	749	813	22
21852-4235	64-L	20.000	21.500	0.750	508	546	19	21852-4550	64-L	33.500	36.000	0.875	851	914	22
21852-4237	64-L	20.000	22.000	0.875	508	559	22	21852-4553	64-L	35.500	37.500	0.875	902	953	22
21852-4239	64-L	20.250	21.750	0.750	514	552	19	21852-4563	64-L	44.500	46.000	0.750	1130	1168	19
21852-4240	64-L	20.250	22.250	0.875	514	565	22	21852-4611	64	11.000	12.500	0.688	279	318	17
21852-4246	64-L	20.500	22.500	0.875	521	572	22	21852-4613	64	12.250	13.750	0.688	311	349	17
21852-4248	64-L	20.750	22.750	0.875	527	578	22	21852-4615	64-L	15.250	16.750	0.688	387	425	17
21852-4253	64-L	21.000	23.000	0.875	533	584	22	21852-4617	64-L	19.250	20.750	0.750	489	527	19
21852-4254	64-L	21.250	23.250	0.875	540	591	22	21852-4619	64-L	20.500	22.000	0.750	521	559	19
21852-4259	64-L	21.500	23.500	0.875	546	597	22	21852-4631	64-L	31.250	32.750	0.750	794	832	19
21852-4265	64-L	21.750	23.750	0.875	552	603	22	21852-4632	64-L	32.000	34.000	0.875	813	864	22
21852-4269	64-L	22.000	23.500	0.750	559	597	19	21852-4635	64-L	41.500	43.500	0.875	1054	1105	22
21852-4270	64-L	22.000	24.000	0.875	559	610	22	21852-4639	64-L	48.250	50.250	0.875	1226	1276	22
21852-4279	64-L	22.500	24.500	0.875	572	622	22	21852-4856	64-L	62.000	64.000	0.813	1575	1626	21
21852-4281	64-L	22.750	24.750	0.875	578	629	22	21852-5033	64-L	31.250	33.250	0.750	794	845	19
21852-4283	64-L	23.000	24.500	0.750	584	622	19	21852-5054	64-L	17.500	19.250	0.688	445	489	17
21852-4284	64-L	23.000	25.000	0.875	584	635	22	21852-5921	64-L	26.000	27.625	0.750	660	702	19
21852-4285	64-L	23.000	25.500	0.875	584	648	22	21852-5989	64	10.125	11.750	0.688	257	298	17
21852-4288	64-L	23.500	25.500	0.875	597	648	22	21852-5990	64-L	14.750	16.500	0.688	375	419	17
21852-4291	64-L	23.563	25.375	0.750	599	645	19	21852-5991	64-L	14.000	15.750	0.688	356	400	17
21852-4294	64-L	24.000	26.000	0.875	610	660	22	21852-5992	64-L	15.313	17.313	0.688	389	440	17
21852-4300	64-L	25.500	27.000	0.875	648	686	22	21852-6239	64-L	23.750	25.250	1.000	603	641	25
21852-4301	64-L	24.250	26.250	0.875	616	667	22	21852-6874	64-L	15.750	17.750	0.688	400	451	17
21852-4304	64-L	24.438	26.437	0.750	621	671	19	21852-6967	64-L	17.250	18.750	0.750	438	476	19

All dimensions are in inches. Preferred sizes are indicated with **bold** type face. Sizes listed are for standard nitrile elements, except Models 25 and 62 which have PTFE elements. Other material available on inquiry only.

## Oil Seals by Model Number

Product Code	Model	Inches			MM			Product Code	Model	Inches			MM		
		ID	OD	Width	ID	OD	Width			ID	OD	Width	ID	OD	Width
21852-7161	64-L	30.500	32.500	0.750	775	826	19	21518-1642	66	2.375	3.125	0.375	60	79	10
21852-7266	64-L	20.047	24.016	0.787	509	610	20	21518-1654	66	2.375	3.250	0.375	60	83	10
21852-7281	64-L	18.897	20.472	0.787	480	520	20	21518-2035	66	2.750	3.500	0.375	70	89	10
21852-8453	64	8.500	10.000	0.688	216	254	17	21518-2753	66	4.500	5.500	0.500	114	140	13
21852-8594	64-L	54.331	56.693	0.984	1380	1440	25	21518-5704	66	1.250	1.875	0.375	32	48	10
21852-8903	64-L	45.000	46.625	1.000	1143	1184	25	21518-8887	66	1.250	1.750	0.375	32	44	10
21852-9176	64	7.875	9.375	0.688	200	238	17	21527-0015	66	0.375	0.875	0.250	10	22	6
21852-9271	64-L	15.750	17.312	0.688	400	440	17	21527-0139	66	0.750	1.250	0.313	19	32	8
21852-9863	64-L	16.500	18.000	0.688	419	457	17	21527-0213	66	0.875	1.375	0.313	22	35	8
21854-4101	64-L	13.250	14.750	0.688	337	375	17	21527-0219	66	0.875	1.625	0.313	22	41	8
21854-4135	64-L	14.000	16.000	0.813	356	406	21	21527-0223	66	0.875	1.828	0.375	22	46	10
21854-4330	64-L	26.125	28.125	0.875	664	714	22	21527-0251	66	0.938	1.500	0.312	24	38	8
21854-8577	64-L	30.500	33.000	0.875	775	838	22	21527-0321	66	1.063	1.575	0.313	27	40	8
21899-4405	64-L	34.500	36.500	0.875	876	927	22	21527-0351	66	1.125	1.625	0.313	29	41	8
21937-3501	64	7.000	8.500	0.750	178	216	19	21527-0353	66	1.125	1.750	0.375	29	44	10
21937-3939	64	8.625	10.125	0.688	219	257	17	21527-0387	66	1.188	2.000	0.375	30	51	10
21937-3954	64	9.000	10.500	0.688	229	267	17	21527-0394	66	1.188	2.125	0.375	30	54	10
21937-3984	64	9.500	11.500	0.813	241	292	21	21527-0424	66	1.250	1.984	0.375	32	50	10
21937-4011	64	10.500	12.000	0.688	267	305	17	21527-0427	66	1.250	2.000	0.375	32	51	10
21937-4118	64-L	14.250	15.750	0.688	362	400	17	21527-0442	66	1.250	2.375	0.375	32	60	10
21937-4128	64-L	13.500	15.500	0.813	343	394	21	21527-0445	66	1.250	2.437	0.375	32	62	10
21937-4142	64-L	14.500	16.000	0.688	368	406	17	21527-0535	66	1.375	2.062	0.375	35	52	10
21937-4180	64-L	16.000	18.000	0.813	406	457	21	21527-0643	66	1.500	2.250	0.375	38	57	10
21937-4186	64-L	16.500	18.500	0.813	419	470	21	21527-0646	66	1.500	2.375	0.375	38	60	10
21937-4194	64-L	17.500	19.000	0.688	445	483	17	21527-0700	66	1.563	2.250	0.375	40	57	10
21937-4237	64-L	20.000	22.000	0.875	508	559	22	21527-0703	66	1.563	2.375	0.375	40	60	10
21937-4361	64-L	30.313	32.375	0.875	770	822	22	21527-0715	66	1.563	2.625	0.375	40	67	10
21957-4341	64-L	27.875	29.813	0.875	708	757	22	21527-0721	66	1.562	2.750	0.375	40	70	10
21957-4365	64-L	30.500	32.500	0.875	775	826	22	21527-0760	66	1.625	2.375	0.375	41	60	10
21957-4389	64-L	33.500	35.500	0.875	851	902	22	21527-0763	66	1.625	2.437	0.375	41	62	10
21957-4613	64	12.250	13.750	0.688	311	349	17	21527-0772	66	1.625	2.625	0.375	41	67	10
21957-5482	64-L	59.000	61.000	0.875	1499	1549	22	21527-0787	66	1.625	2.875	0.375	41	73	10
21957-7065	64-L	53.150	55.669	0.866	1350	1414	22	21527-0838	66	1.688	2.625	0.375	43	67	10
21957-8577	64-L	30.500	33.000	0.875	775	838	22	21527-0898	66	1.750	2.437	0.375	44	62	10
21370-0351	66	1.125	1.625	0.313	29	41	8	21527-0904	66	1.750	2.500	0.375	44	64	10
21370-0760	66	1.625	2.375	0.375	41	60	10	21527-0913	66	1.750	2.750	0.375	44	70	10
21370-1042	66	1.875	2.625	0.375	48	67	10	21527-0922	66	1.750	2.875	0.375	44	73	10
21370-1189	66	2.000	2.750	0.375	51	70	10	21527-0931	66	1.750	3.062	0.375	44	78	10
21370-2753	66	4.500	5.500	0.500	114	140	13	21527-1042	66	1.875	2.625	0.375	48	67	10
21455-0213	66	0.875	1.375	0.313	22	35	8	21527-1051	66	1.875	2.756	0.375	48	70	10
21455-2372	66	3.500	4.750	0.500	89	121	13	21527-1066	66	1.875	3.062	0.375	48	78	10
21463-8258	66	1.875	3.000	0.563	48	76	14	21527-1117	66	1.938	2.686	0.375	49	68	10
21467-0843	66	1.688	2.686	0.500	43	68	13	21527-1141	66	1.938	3.125	0.375	49	79	10
21476-0427	66	1.250	2.000	0.375	32	51	10	21527-1144	66	1.938	3.147	0.375	49	80	10
21481-0387	66	1.188	2.000	0.375	30	51	10	21527-1150	66	1.969	2.686	0.375	50	68	10
21481-0389	66	1.188	2.062	0.375	30	52	10	21527-1156	66	1.969	2.756	0.375	50	70	10
21481-1807	66	2.500	3.250	0.375	64	83	10	21527-1168	66	1.969	3.000	0.375	50	76	10
21481-2366	66	3.500	4.500	0.500	89	114	13	21527-1189	66	2.000	2.750	0.375	51	70	10
21481-4640	66	3.500	4.500	0.469	89	114	12	21527-1252	66	2.062	2.875	0.375	52	73	10
21482-0215	66	0.875	1.500	0.312	22	38	8	21527-1258	66	2.062	3.000	0.375	52	76	10
21482-1669	66	2.375	3.543	0.375	60	90	10	21527-1321	66	2.125	2.875	0.375	54	73	10
21482-1816	66	2.500	3.481	0.375	64	88	10	21527-1327	66	2.125	3.000	0.375	54	76	10
21482-3234	66	5.625	6.875	0.500	143	175	13	21527-1357	66	2.125	3.500	0.375	54	89	10
21482-6300	66	2.563	3.937	0.375	65	100	10	21527-1405	66	2.188	3.063	0.375	56	78	10
21515-2669	66	4.250	5.750	0.500	108	146	13	21527-1426	66	2.188	3.372	0.375	56	86	10
21518-0618	66	1.375	1.875	0.375	35	48	10	21527-1474	66	2.250	3.000	0.375	57	76	10

All dimensions are in inches. Preferred sizes are indicated with **bold** type face. Sizes listed are for standard nitrile elements, except Models 25 and 62 which have PTFE elements. Other material available on inquiry only.



## Oil Seals by Model Number

Product Code	Model	Inches			MM			Product Code	Model	Inches			MM		
		ID	OD	Width	ID	OD	Width			ID	OD	Width	ID	OD	Width
21527-1504	66	2.250	3.500	0.375	57	89	10	21920-0015	66	0.375	0.875	0.250	10	22	6
21527-1642	66	2.375	3.125	0.375	60	79	10	21920-1189	66	2.000	2.750	0.375	51	70	10
21527-1648	66	2.375	3.189	0.375	60	81	10	21920-1474	66	2.250	3.000	0.375	57	76	10
21527-1654	66	2.375	3.250	0.375	60	83	10	21920-1933	66	2.625	3.372	0.375	67	86	10
21527-1656	66	2.375	3.250	0.500	60	83	13	21920-2170	66	3.000	3.751	0.500	76	95	13
21527-1807	66	2.500	3.250	0.375	64	83	10	21528-0051	67	0.500	1.125	0.313	13	29	8
21527-1825	66	2.500	3.623	0.375	64	92	10	21528-0055	67	0.500	1.375	0.313	13	35	8
21527-1930	66	2.625	3.350	0.375	67	85	10	21528-0067	67	0.563	1.125	0.313	14	29	8
21527-1933	66	2.625	3.372	0.375	67	86	10	21528-0087	67	0.625	1.125	0.313	16	29	8
21527-1945	66	2.625	3.623	0.375	67	92	10	21528-0089	67	0.625	1.250	0.313	16	32	8
21527-2032	66	2.750	3.481	0.375	70	88	10	21528-0117	67	0.688	1.575	0.313	17	40	8
21527-2035	66	2.750	3.500	0.375	70	89	10	21528-0139	67	0.750	1.250	0.313	19	32	8
21527-2037	66	2.750	3.500	0.500	70	89	13	21528-0141	67	0.750	1.375	0.313	19	35	8
21527-2041	66	2.750	3.623	0.375	70	92	10	21528-0143	67	0.750	1.500	0.313	19	38	8
21527-2044	66	2.750	3.751	0.375	70	95	10	21528-0151	67	0.750	1.828	0.375	19	46	10
21527-2168	66	3.000	3.750	0.375	76	95	10	21528-0158	67	0.781	1.250	0.375	20	32	10
21527-2170	66	3.000	3.751	0.500	76	95	13	21528-0160	67	0.781	1.375	0.375	20	35	10
21527-2173	66	3.000	3.876	0.500	76	98	13	21528-0273	67	0.969	1.625	0.312	25	41	8
21527-2174	66	3.000	4.003	0.375	76	102	10	21528-0287	67	1.000	1.500	0.313	25	38	8
21527-2249	66	3.188	4.249	0.500	81	108	13	21528-0291	67	1.000	1.625	0.313	25	41	8
21527-2366	66	3.500	4.500	0.500	89	114	13	21528-0351	67	1.125	1.625	0.313	29	41	8
21527-2462	66	3.750	4.750	0.500	95	121	13	21528-0353	67	1.125	1.750	0.375	29	44	10
21527-2468	66	3.750	4.999	0.500	95	127	13	21528-0357	67	1.125	1.875	0.375	29	48	10
21527-2471	66	3.750	5.125	0.500	95	130	13	21528-0360	67	1.125	2.000	0.438	29	51	11
21527-2537	66	4.000	4.999	0.500	102	127	13	21528-0361	67	1.125	2.062	0.375	29	52	10
21527-2543	66	4.000	5.250	0.500	102	133	13	21528-0363	67	1.156	1.875	0.375	29	48	10
21527-2549	66	4.000	5.500	0.500	102	140	13	21528-0427	67	1.250	2.000	0.375	32	51	10
21527-2555	66	4.000	5.750	0.500	102	146	13	21528-0535	67	1.375	2.062	0.375	35	52	10
21527-2657	66	4.250	5.250	0.500	108	133	13	21528-0544	67	1.375	2.250	0.375	35	57	10
21527-2660	66	4.250	5.375	0.500	108	137	13	21528-0643	67	1.500	2.250	0.375	38	57	10
21527-2663	66	4.250	5.500	0.500	108	140	13	21528-0646	67	1.500	2.375	0.375	38	60	10
21527-2753	66	4.500	5.500	0.500	114	140	13	21528-0700	67	1.563	2.250	0.375	40	57	10
21527-2756	66	4.500	5.625	0.500	114	143	13	21528-0898	67	1.750	2.437	0.375	44	62	10
21527-2762	66	4.500	5.875	0.500	114	149	13	21528-0904	67	1.750	2.500	0.375	44	64	10
21527-2879	66	4.875	6.250	0.500	124	159	13	21528-0928	67	1.750	3.000	0.375	44	76	10
21527-3125	66	5.375	6.500	0.500	137	165	13	21528-1048	67	1.875	2.750	0.375	48	70	10
21527-3275	66	5.750	6.750	0.500	146	171	13	21528-1063	67	1.875	3.000	0.375	48	76	10
21527-3278	66	5.750	6.875	0.500	146	175	13	21528-1189	67	2.000	2.750	0.375	51	70	10
21527-3319	66	5.875	7.000	0.500	149	178	13	21528-1204	67	2.000	3.000	0.375	51	76	10
21527-3580	66	7.875	8.875	0.625	200	225	16	21528-1321	67	2.125	2.875	0.375	54	73	10
21527-3588	66	7.875	9.375	0.625	200	238	16	21528-1807	67	2.500	3.250	0.375	64	83	10
21527-3877	66	1.188	2.048	0.375	30	52	10	21528-2032	67	2.750	3.481	0.375	70	88	10
21527-3888	66	1.875	3.149	0.375	48	80	10	21528-2035	67	2.750	3.500	0.375	70	89	10
21527-4899	66	1.750	3.543	0.437	44	90	11	21528-2041	67	2.750	3.623	0.375	70	92	10
21527-6486	66	1.562	3.544	0.375	40	90	10	21528-2050	67	2.750	4.003	0.375	70	102	10
21527-6658	66	1.375	2.441	0.375	35	62	10	21528-2168	67	3.000	3.751	0.375	76	95	10
21527-6724	66	1.750	3.125	0.375	44	79	10	21528-5551	67	3.250	4.000	0.375	83	102	10
21527-7242	66	1.125	2.125	0.375	29	54	10	21923-0143	67	0.750	1.500	0.313	19	38	8
21527-7249	66	3.750	5.375	0.500	95	137	13	21923-0215	67	0.875	1.500	0.313	22	38	8
21527-8347	66	0.875	1.378	0.313	22	35	8	21923-0269	67	0.969	1.500	0.313	25	38	8
21527-8369	66	2.375	3.150	0.375	60	80	10	21923-0351	67	1.125	1.625	0.313	29	41	8
21527-8456	66	1.750	3.625	0.437	44	92	11	21923-0535	67	1.375	2.062	0.375	35	52	10
21789-1063	66	1.875	3.000	0.375	48	76	10	21923-0700	67	1.563	2.250	0.375	40	57	10
21789-8347	66	0.875	1.378	0.313	22	35	8	21923-1801	67	2.500	3.189	0.375	64	81	10
21900-1066	66	1.875	3.062	0.375	48	78	10	21951-0143	67	0.750	1.500	0.313	19	38	8
21900-1408	66	2.188	3.125	0.375	56	79	10	21951-0269	67	0.969	1.500	0.313	25	38	8

All dimensions are in inches. Preferred sizes are indicated with **bold** type face.

Sizes listed are for standard nitrile elements, except Models 25 and 62 which have PTFE elements. Other material available on inquiry only.

## Oil Seals by Model Number

Product Code	Model	Inches			MM			Product Code	Model	Inches			MM		
		ID	OD	Width	ID	OD	Width			ID	OD	Width	ID	OD	Width
21951-0351	67	1.125	1.625	0.313	29	41	8	26001-6242	71	1.750	2.125	0.188	44	54	5
21951-0535	67	1.375	2.062	0.375	35	52	10	26001-6267	71	2.000	2.250	0.109	51	57	3
21951-0700	67	1.563	2.250	0.375	40	57	10	26001-6284	71	2.250	2.625	0.109	57	67	3
21951-6233	67	0.938	1.375	0.312	24	35	8	26001-6304	71	2.750	3.125	0.188	70	79	5
21959-0143	67	0.750	1.500	0.313	19	38	8	26001-6308	71	3.000	3.500	0.250	76	89	6
21959-0215	67	0.875	1.500	0.313	22	38	8	26001-7004	71	0.375	0.563	0.094	10	14	2
21959-0269	67	0.969	1.500	0.313	25	38	8	26001-7005	71	0.375	0.625	0.125	10	16	3
21959-0303	67	1.000	2.062	0.375	25	52	10	26001-7007	71	0.438	0.875	0.188	11	22	5
21959-0351	67	1.125	1.625	0.313	29	41	8	26001-7009	71	0.469	0.703	0.125	12	18	3
21959-0363	67	1.156	1.875	0.375	29	48	10	26001-7011	71	0.500	0.688	0.094	13	17	2
21959-0427	67	1.250	2.000	0.375	32	51	10	26001-7012	71	0.500	0.688	0.125	13	17	3
21959-0535	67	1.375	2.062	0.375	35	52	10	26001-7013	71	0.500	0.750	0.125	13	19	3
21959-0544	67	1.375	2.250	0.375	35	57	10	26001-7017	71	0.563	0.750	0.094	14	19	2
21959-0700	67	1.563	2.250	0.375	40	57	10	26001-7020	71	0.625	0.813	0.094	16	21	2
21959-0904	67	1.750	2.500	0.375	44	64	10	26001-7021	71	0.625	1.000	0.250	16	25	6
21959-1801	67	2.500	3.189	0.375	64	81	10	26001-7022	71	0.625	1.062	0.188	16	27	5
21959-2168	67	3.000	3.375	0.375	76	86	10	26001-7023	71	0.625	1.125	0.188	16	29	5
21959-2174	67	3.000	4.003	0.375	76	102	10	26001-7024	71	0.625	1.000	0.125	16	25	3
21959-5551	67	3.250	4.000	0.375	83	102	10	26001-7025	71	0.688	0.875	0.094	17	22	2
21993-0361	67	1.125	2.062	0.375	29	52	10	26001-7027	71	0.750	1.000	0.125	19	25	3
21993-0544	67	1.375	2.250	0.375	35	57	10	26001-7028	71	0.750	1.062	0.188	19	27	5
21378-0361	68	1.125	2.062	0.375	29	52	10	26001-7030	71	0.750	1.125	0.125	19	29	3
21378-0544	68	1.375	2.250	0.375	35	57	10	26001-7031	71	0.750	1.188	0.156	19	30	4
21823-0051	68	0.500	1.125	0.313	13	29	8	26001-7032	71	0.750	1.250	0.125	19	32	3
21823-0273	68	0.969	1.625	0.313	25	41	8	26001-7033	71	0.750	1.250	0.250	19	32	6
21823-0287	68	1.000	1.500	0.313	25	38	8	26001-7034	71	0.750	1.375	0.250	19	35	6
21823-0643	68	1.500	2.250	0.375	38	57	10	26001-7037	71	0.813	1.062	0.125	21	27	3
21823-0646	68	1.500	2.375	0.375	38	60	10	26001-7038	71	0.813	1.066	0.125	21	27	3
21823-0898	68	1.750	2.437	0.375	44	62	10	26001-7041	71	0.875	1.125	0.125	22	29	3
21823-0913	68	1.750	2.750	0.375	44	70	10	26001-7042	71	0.875	1.188	0.156	22	30	4
21823-1189	68	2.000	2.750	0.375	51	70	10	26001-7045	71	0.875	1.375	0.125	22	35	3
21823-1204	68	2.000	3.000	0.375	51	76	10	26001-7047	71	0.938	1.188	0.125	24	30	3
21823-1471	68	2.250	2.997	0.375	57	76	10	26001-7049	71	1.000	1.250	0.125	25	32	3
21823-1801	68	2.500	3.189	0.375	64	81	10	26001-7052	71	1.000	1.500	0.125	25	38	3
21823-1804	68	2.500	3.246	0.375	64	82	10	26001-7055	71	1.000	1.750	0.250	25	44	6
21823-1807	68	2.500	3.250	0.375	64	83	10	26001-7056	71	1.063	1.563	0.125	27	40	3
21823-1820	68	2.500	3.500	0.438	64	89	11	26001-7057	71	1.125	1.375	0.125	29	35	3
21823-1828	68	2.500	3.751	0.375	64	95	10	26001-7061	71	1.187	1.437	0.125	30	36	3
21823-2035	68	2.750	3.500	0.375	70	89	10	26001-7062	71	1.250	1.500	0.125	32	38	3
21823-2168	68	3.000	3.751	0.375	76	95	10	26001-7068	71	1.375	1.625	0.125	35	41	3
21823-2176	68	3.000	4.003	0.500	76	102	13	26001-7070	71	1.438	1.750	0.156	37	44	4
26001-0013	71	0.375	0.750	0.250	10	19	6	26001-7080	71	1.750	2.250	0.250	44	57	6
26001-2131	71	1.218	1.625	0.187	31	41	5	26001-7081	71	1.750	2.375	0.250	44	60	6
26001-5064	71	2.125	2.500	0.250	54	64	6	26001-7083	71	1.813	2.375	0.188	46	60	5
26001-5239	71	1.250	1.750	0.250	32	44	6	26001-7084	71	1.875	2.375	0.250	48	60	6
26001-6060	71	0.438	0.688	0.125	11	17	3	26001-7085	71	1.938	2.375	0.188	49	60	5
26001-6151	71	1.000	1.313	0.125	25	33	3	26001-7088	71	2.438	2.938	0.188	62	75	5
26001-6156	71	1.000	1.563	0.188	25	40	5	26001-7089	71	2.500	3.125	0.250	64	79	6
26001-6169	71	1.125	1.625	0.250	29	41	6	26001-7090	71	2.500	3.250	0.250	64	83	6
26001-6222	71	1.500	1.875	0.125	38	48	3	26001-7092	71	2.625	3.250	0.188	67	83	5
26001-6223	71	1.500	1.875	0.188	38	48	5	26001-7093	71	2.750	3.125	0.109	70	79	3
26001-6226	71	1.625	1.875	0.109	41	48	3	26001-7095	71	3.500	3.875	0.188	89	98	5
26001-6227	71	1.625	2.000	0.109	41	51	3	26001-7096	71	3.500	4.003	0.250	89	102	6
26001-6230	71	1.625	2.375	0.250	41	60	6	26001-7097	71	3.750	4.375	0.313	95	111	8
26001-6240	71	1.750	2.000	0.109	44	51	3	26001-7530	71	2.000	2.375	0.188	51	60	5
26001-6241	71	1.750	2.125	0.125	44	54	3	26001-7546	71	4.250	4.813	0.109	108	122	3

All dimensions are in inches. Preferred sizes are indicated with **bold** type face.  
 Sizes listed are for standard nitrile elements, except Models 25 and 62 which have PTFE elements. Other material available on inquiry only.

## Oil Seals by Model Number

Product Code	Model	Inches			MM			Product Code	Model	Inches			MM		
		ID	OD	Width	ID	OD	Width			ID	OD	Width	ID	OD	Width
26001-7705	71	0.781	1.250	0.188	20	32	5	26080-1184	87-L	15.748	17.480	0.787	400	444	20
26001-7826	71	0.750	0.938	0.125	19	24	3	26080-1202	87-L	14.173	15.906	0.787	360	404	20
26001-8379	71	0.667	1.188	0.125	17	30	3	26080-1382	87-L	22.047	23.780	0.709	560	604	18
26001-8810	71	3.250	3.813	0.109	83	97	3	26080-1383	87-L	19.685	21.654	0.787	500	550	20
26001-9016	71	4.000	4.500	0.250	102	114	6	26080-1387	87-L	17.126	19.094	0.787	435	485	20
26001-9428	71	0.625	1.125	0.125	16	29	3	26080-1392	87	8.661	10.236	0.787	220	260	20
26001-9668	71	3.500	4.062	0.109	89	103	3	26080-2027	87-L	30.500	33.000	1.000	775	838	25
26001-9758	71	0.688	1.375	0.125	17	35	3	26080-2134	87-L	14.488	16.496	0.811	368	419	21
26002-7056	71	1.063	1.563	0.125	27	40	3	26080-2207	87-L	25.000	27.000	0.906	635	686	23
26193-0013	76	0.375	0.750	0.250	10	19	6	26080-2268	87	8.250	10.260	0.688	210	261	17
26193-0132	76	1.496	2.441	0.315	38	62	8	26080-3177	87	7.087	8.661	0.787	180	220	20
26193-0134	76	1.378	2.047	0.276	35	52	7	26080-3326	87-L	15.000	16.500	0.625	381	419	16
26193-0136	76	1.457	1.732	0.197	37	44	5	26080-3831	87-L	34.750	36.750	0.875	883	933	22
26193-0168	76	0.394	0.787	0.157	10	20	4	26080-3832	87	8.875	10.125	0.625	225	257	16
26193-0174	76	0.787	1.654	0.315	20	42	8	26080-4030	87	10.750	12.750	0.750	273	324	19
26193-0190	76	0.630	1.102	0.276	16	28	7	26080-4142	87-L	14.500	16.000	0.688	368	406	17
26193-0200	76	0.472	0.866	0.276	12	22	7	26080-4170	87-L	15.750	17.250	0.687	400	438	17
26193-0345	76	2.165	3.150	0.472	55	80	12	26080-4177	87-L	16.000	17.500	0.687	406	445	17
26193-0373	76	1.969	3.543	0.394	50	90	10	26080-4218	87-L	19.000	20.500	0.750	483	521	19
26193-0920	76	1.457	1.654	0.157	37	42	4	26080-4270	87	22.000	24.000	0.875	559	610	22
26193-5299	76	0.625	0.875	0.187	16	22	5	26080-4281	87-L	22.750	24.750	0.875	578	629	22
26193-6071	76	0.500	0.801	0.188	13	20	5	26080-4285	87-L	23.000	25.500	0.875	584	648	22
26193-6133	76	0.875	1.250	0.188	22	32	5	26080-4348	87-L	29.000	31.000	0.875	737	787	22
26193-6183	76	1.250	1.625	0.188	32	41	5	26080-4390	87-L	24.409	26.378	0.866	620	670	22
26193-6195	76	1.313	1.625	0.156	33	41	4	26080-4498	87-L	40.000	42.000	1.000	1016	1067	25
26193-6223	76	1.500	1.875	0.188	38	48	5	26080-4603	87-L	13.780	15.512	0.787	350	394	20
26193-6233	76	0.938	1.375	0.313	24	35	8	26080-4635	87-L	41.500	43.500	0.875	1054	1105	22
26193-6242	76	1.750	2.125	0.188	44	54	5	26080-4950	87	10.000	11.500	0.625	254	292	16
26193-6591	76	3.250	3.940	0.250	83	100	6	26080-5077	87-L	16.000	18.000	0.875	406	457	22
26193-7501	76	0.500	0.875	0.313	13	22	8	26080-5168	87-L	17.000	19.000	0.750	432	483	19
26193-7503	76	0.563	0.875	0.188	14	22	5	26080-5334	87	9.055	10.236	0.591	230	260	15
26193-7504	76	0.563	1.000	0.188	14	25	5	26080-6348	87-L	45.000	47.000	0.813	1143	1194	21
26193-7505	76	0.688	1.062	0.188	17	27	5	26080-6374	87	7.000	8.000	0.500	178	203	13
26193-7510	76	1.000	1.438	0.250	25	37	6	26080-6618	87-L	15.250	17.250	0.625	387	438	16
26193-7512	76	1.125	1.500	0.188	29	38	5	26080-6787	87-L	33.000	34.625	0.750	838	879	19
26193-7516	76	1.250	1.688	0.188	32	43	5	26080-6980	87-L	19.500	21.500	0.750	495	546	19
26193-7517	76	1.500	2.000	0.250	38	51	6	26081-1382	87-L	22.047	23.780	0.709	560	604	18
26193-7519	76	1.313	1.750	0.188	33	44	5	26081-1383	87-L	19.685	21.654	0.787	500	550	20
26193-7520	76	1.375	1.750	0.188	35	44	5	26081-1387	87-L	17.126	19.094	0.787	435	485	20
26193-7527	76	1.688	2.125	0.188	43	54	5	26081-1392	87	8.661	10.236	0.787	220	260	20
26193-7530	76	2.000	2.375	0.188	51	60	5	26081-2134	87-L	14.488	16.496	0.811	368	419	21
26193-7532	76	2.500	3.062	0.250	64	78	6	26081-2388	87-L	20.866	22.441	0.787	530	570	20
26193-7694	76	2.000	3.544	0.375	51	90	10	26081-2454	87	12.205	13.937	0.787	310	354	20
26193-7995	76	2.125	2.762	0.250	54	70	6	26081-3177	87	7.087	8.661	0.787	180	220	20
26193-8876	76	3.063	4.003	0.375	78	102	10	26081-3566	87	7.625	9.125	0.625	194	232	16
26193-8952	76	0.875	1.575	0.188	22	40	5	26081-3832	87	8.875	10.125	0.625	225	257	16
26193-9329	76	0.469	0.875	0.312	12	22	8	26081-4030	87	10.750	12.750	0.750	273	324	19
26193-9518	76	1.000	1.375	0.188	25	35	5	26081-4170	87-L	15.750	17.250	0.687	400	438	17
26193-9578	76	8.000	8.875	0.438	203	225	11	26081-4177	87-L	16.000	17.500	0.687	406	445	17
26193-9675	76	1.750	2.250	0.313	44	57	8	26081-4218	87-L	19.000	20.500	0.750	483	521	19
26193-9768	76	1.938	2.438	0.313	49	62	8	26081-4421	87-L	36.000	38.000	0.875	914	965	22
26193-9879	76	4.000	4.625	0.312	102	117	8	26081-4805	87	10.236	11.969	0.787	260	304	20
26193-9971	76	1.625	2.125	0.250	41	54	6	26081-5334	87	9.055	10.236	0.591	230	260	15
27769-6183	76	1.250	1.625	0.188	32	41	5	26081-6374	87	7.000	8.000	0.500	178	203	13
26077-4465	87-L	39.000	41.000	0.875	991	1041	22	26081-6657	87-L	16.250	18.250	0.750	413	464	19
26080-1040	87-L	12.250	14.250	1.250	311	362	32	26081-6980	87-L	19.500	21.500	0.750	495	546	19

All dimensions are in inches. Preferred sizes are indicated with **bold** type face.

Sizes listed are for standard nitrile elements, except Models 25 and 62 which have PTFE elements. Other material available on inquiry only.

## Oil Seals by Model Number

Product Code	Model	Inches			MM			Product Code	Model	Inches			MM		
		ID	OD	Width	ID	OD	Width			ID	OD	Width	ID	OD	Width
26081-9927	87-L	14.000	15.750	0.875	356	400	22	26088-3784	88-L	27.500	29.500	1.000	699	749	25
26082-1040	87-L	12.250	14.250	1.250	311	362	32	26088-3878	88-L	28.000	30.500	0.875	711	775	22
26082-1083	87-L	22.750	25.500	0.875	578	648	22	26088-3934	88	8.375	9.875	0.750	213	251	19
26082-2884	87-L	24.803	26.181	0.563	630	665	14	26088-4071	88-L	12.000	14.000	0.750	305	356	19
26082-2886	87-L	50.984	52.165	0.787	1295	1325	20	26088-4079	88-L	12.500	14.000	0.688	318	356	17
26082-3891	87-L	14.250	16.250	0.625	362	413	16	26088-4121	88-L	13.500	15.000	0.688	343	381	17
26082-4030	87	10.750	12.750	0.750	273	324	19	26088-4145	88-L	14.500	16.500	0.813	368	419	21
26082-4142	87-L	14.500	16.000	0.688	368	406	17	26088-4163	88-L	15.500	17.500	0.813	394	445	21
26082-4231	87-L	20.000	22.000	0.625	508	559	16	26088-4170	88-L	15.750	17.250	0.688	400	438	17
26082-4281	87-L	22.750	24.750	0.875	578	629	22	26088-4181	88-L	16.250	17.750	0.688	413	451	17
26082-4285	87-L	23.000	25.500	0.875	584	648	22	26088-4186	88-L	16.500	18.500	0.813	419	470	21
26082-4635	87-L	41.500	43.500	0.875	1054	1105	22	26088-4188	88-L	17.000	18.500	0.688	432	470	17
26082-5077	87-L	16.000	18.000	0.875	406	457	22	26088-4216	88-L	18.500	20.500	0.875	470	521	22
26095-2454	87	12.205	13.937	0.787	310	354	20	26088-4218	88-L	19.000	20.500	0.750	483	521	19
26095-2909	87-L	53.000	55.000	0.781	1346	1397	20	26088-4239	88-L	20.250	21.750	0.750	514	552	19
26095-4729	87	6.125	7.625	0.750	156	194	19	26088-4246	88-L	20.500	22.500	0.875	521	572	22
26095-4805	87	10.236	11.969	0.787	260	304	20	26088-4248	88-L	20.750	22.750	0.875	527	578	22
26095-5077	87-L	16.000	18.000	0.875	406	457	22	26088-4254	88-L	21.250	23.250	0.875	540	591	22
26095-6348	87-L	45.000	47.000	0.813	1143	1194	21	26088-4265	88-L	21.750	23.750	0.875	552	603	22
26095-6374	87	7.000	8.000	0.500	178	203	13	26088-4318	88-L	25.500	27.500	0.875	648	699	22
26097-2388	87-L	20.866	22.441	0.787	530	570	20	26088-4333	88-L	27.000	29.000	0.875	686	737	22
26097-4270	87-L	22.000	24.000	0.875	559	610	22	26088-4346	88-L	28.500	30.500	0.875	724	775	22
26097-5077	87-L	16.000	18.000	0.875	406	457	22	26088-4365	88-L	30.500	32.500	0.875	775	826	22
26097-6374	87	7.000	8.000	0.500	178	203	13	26088-4377	88-L	32.500	34.500	0.875	826	876	22
26098-2208	87-L	28.000	30.500	1.000	711	775	25	26088-4382	88-L	33.000	35.000	0.875	838	889	22
26098-2547	87-L	23.000	25.500	1.000	584	648	25	26088-4389	88-L	33.500	35.500	0.875	851	902	22
26098-4318	87-L	25.500	27.500	0.875	648	699	22	26088-4550	88-L	33.500	36.000	0.875	851	914	22
26098-4357	87-L	30.000	32.000	0.875	762	813	22	26088-4567	88-L	38.250	40.750	0.875	972	1035	22
26099-1382	87-L	22.047	23.780	0.709	560	604	18	26088-4685	88-L	37.813	40.945	0.875	960	1040	22
26099-1383	87-L	19.685	21.654	0.787	500	550	20	26088-4704	88-L	17.559	19.134	0.630	446	486	16
26099-1387	87-L	17.126	19.094	0.787	435	485	20	26088-5116	88-L	16.000	18.000	0.750	406	457	19
26084-7391	88	11.024	12.598	0.787	280	320	20	26088-5334	88	9.055	10.236	0.591	230	260	15
26085-1593	88-L	31.496	33.071	0.787	800	840	20	26088-5619	88-L	21.000	23.000	0.750	533	584	19
26085-2718	88-L	32.835	34.803	0.984	834	884	25	26088-5921	88-L	26.000	27.625	0.750	660	702	19
26085-4472	88-L	41.500	43.000	0.750	1054	1092	19	26088-5997	88-L	25.000	27.500	0.875	635	699	22
26086-1382	88-L	22.047	23.780	0.709	560	604	18	26088-6185	88	7.750	8.750	0.438	197	222	11
26086-1383	88-L	19.685	21.654	0.787	500	550	20	26088-6264	88-L	13.250	15.250	0.750	337	387	19
26086-1387	88-L	17.126	19.094	0.787	435	485	20	26088-6383	88	8.500	9.500	0.500	216	241	13
26086-2982	88-L	13.500	15.500	0.688	343	394	17	26088-6386	88	8.750	10.000	0.625	222	254	16
26086-3067	88	5.250	6.500	0.625	133	165	16	26088-6618	88-L	15.250	17.250	0.625	387	438	16
26086-3522	88	7.250	8.500	0.625	184	216	16	26088-6787	88-L	33.000	34.625	0.750	838	879	19
26086-4071	88-L	12.000	14.000	0.750	305	356	19	26088-6829	88-L	12.250	14.250	0.750	311	362	19
26086-4128	88-L	13.500	15.500	0.813	343	394	21	26088-6980	88-L	19.500	21.500	0.750	495	546	19
26086-4170	88-L	15.750	17.250	0.688	400	438	17	26088-7539	88-L	15.250	17.250	0.750	387	438	19
26086-4218	88-L	19.000	20.500	0.750	483	521	19	26088-7788	88-L	29.500	32.000	0.750	749	813	19
26086-5116	88-L	16.000	18.000	0.750	406	457	19	26088-7810	88-L	37.500	39.500	0.750	953	1003	19
26086-5334	88	9.055	10.236	0.591	230	260	15	26088-7870	88-L	30.000	31.625	0.750	762	803	19
26086-5619	88-L	21.000	23.000	0.750	533	584	19	26088-8487	88-L	30.000	31.600	0.775	762	803	20
26086-6829	88-L	12.250	14.250	0.750	311	362	19	26088-8525	88-L	11.811	13.543	0.807	300	344	21
26086-6980	88-L	19.500	21.500	0.750	495	546	19	26088-8606	88	8.661	10.236	0.630	220	260	16
26086-7539	88-L	15.250	17.250	0.750	387	438	19	26088-8664	88-L	14.344	16.000	0.688	364	406	17
26088-1383	88-L	19.685	21.654	0.787	500	550	20	26088-8794	88-L	14.750	16.500	0.875	375	419	22
26088-1387	88-L	17.126	19.094	0.787	435	485	20	26088-9126	88	7.375	8.375	0.637	187	213	16
26088-2676	88-L	14.500	16.000	0.563	368	406	14	26090-4248	88-L	20.750	22.750	0.875	527	578	22
26088-2982	88-L	13.500	15.500	0.688	343	394	17	26090-4318	88-L	25.500	27.500	0.875	648	699	22
26088-3764	88-L	22.250	24.250	0.875	565	616	22	26090-5116	88-L	16.000	18.000	0.750	406	457	19

All dimensions are in inches. Preferred sizes are indicated with **bold** type face. Sizes listed are for standard nitrile elements, except Models 25 and 62 which have PTFE elements. Other material available on inquiry only.

## Oil Seals by Model Number

Product Code	Model	Inches			MM			Product Code	Model	Inches			MM		
		ID	OD	Width	ID	OD	Width			ID	OD	Width	ID	OD	Width
26090-6264	88-L	13.250	15.250	0.750	337	387	19	27223-7198	94	0.781	1.850	0.375	20	47	10
26090-6829	88-L	12.250	14.250	0.750	311	362	19	27223-7209	94	2.165	3.938	0.375	55	100	10
26188-8525	88	11.811	13.543	0.807	300	344	20	27223-7465	94	0.875	1.570	0.313	22	40	8
26588-2982	88-L	13.500	15.500	0.688	343	394	17	27223-7636	94	1.625	3.750	0.750	41	95	19
26588-3784	88-L	27.500	29.500	1.000	699	749	25	27223-7779	94	0.969	2.441	0.375	25	62	10
26588-4071	88-L	12.000	14.000	0.750	305	356	19	27223-8004	94	1.766	2.953	0.313	45	75	8
26588-4128	88-L	13.500	15.500	0.813	343	394	21	27223-8005	94	1.969	4.331	0.375	50	110	10
26588-4181	88-L	16.250	17.750	0.688	413	451	17	27223-8006	94	2.165	3.544	0.375	55	90	10
26588-4270	88-L	22.000	24.000	0.875	559	610	22	27223-8958	94	2.165	3.250	0.375	55	83	10
26588-4346	88-L	28.500	30.500	0.875	724	775	22	27223-8959	94	2.531	4.725	0.375	64	120	10
26588-6185	88	7.750	8.750	0.438	197	222	11	27223-8960	94	5.500	8.268	0.500	140	210	13
26588-9126	88	7.375	8.375	0.637	187	213	16	27223-9967	94	1.000	1.851	0.250	25	47	6
26688-3878	88-L	28.000	30.500	0.875	711	775	22	21011-2542	111	4.000	5.125	0.625	102	130	16
26688-8487	88-L	30.000	31.600	0.775	762	803	20	21011-2545	111	4.000	5.250	0.625	102	133	16
27023-1223	91	1.625	1.938	0.250	41	49	6	21011-4559	111	5.375	6.688	0.563	137	170	14
27023-2481	91	0.433	1.259	0.146	11	32	4	21697-7703	111	4.919	5.495	0.625	125	140	16
27023-2482	91	0.375	1.259	0.146	10	32	4	21825-2989	111	5.500	6.500	0.438	140	165	11
27023-6053	91	0.313	0.563	0.156	8	14	4	21012-2464	113	3.750	4.750	0.625	95	121	16
27023-6279	91	1.188	1.625	0.250	30	41	6	21012-3355	113	6.000	7.000	0.500	152	178	13
27023-7503	91	0.563	0.875	0.188	14	22	5	21012-4495	113	10.500	12.000	0.625	267	305	16
27023-9574	91	3.000	3.406	0.203	76	87	5	21012-4557	113	3.000	4.000	0.500	76	102	13
27223-0096	94	0.625	1.575	0.375	16	40	10	21012-4558	113	3.250	4.813	0.500	83	122	13
27223-0139	94	0.750	1.250	0.313	19	32	8	21012-4560	113	6.500	7.500	0.500	165	191	13
27223-0141	94	0.750	1.375	0.313	19	35	8	21012-4561	113	7.125	8.125	0.500	181	206	13
27223-0215	94	0.875	1.500	0.313	22	38	8	21016-1210	123	2.000	3.125	0.375	51	79	10
27223-0287	94	1.000	1.500	0.313	25	38	8	21432-0418	142-L	15.000	16.125	1.375	381	410	35
27223-0359	94	1.125	2.000	0.375	29	51	10	21432-0812	142-L	13.000	14.125	1.375	330	359	35
27223-0592	94	1.438	2.125	0.375	37	54	10	21432-1028	142-L	17.559	18.683	1.375	446	475	35
27223-0940	94	1.781	2.625	0.375	45	67	10	21432-1133	142-L	24.500	26.000	1.000	622	660	25
27223-1261	94	2.062	3.062	0.375	52	78	10	21432-1243	142	8.228	9.228	0.750	209	234	19
27223-1538	94	2.438	3.375	0.500	62	86	13	21432-1244	142	12.204	13.204	0.750	310	335	19
27223-2628	94	0.669	1.575	0.551	17	40	14	21432-1715	142	12.375	13.500	1.250	314	343	32
27223-3264	94	1.750	2.623	0.438	44	67	11	21432-2015	142-L	17.688	19.188	1.000	449	487	25
27223-4488	94	4.331	6.693	0.500	110	170	13	21432-2263	142-L	18.125	19.625	1.000	460	498	25
27223-4598	94	1.781	3.938	0.375	45	100	10	21432-2310	142	11.417	12.417	0.750	290	315	19
27223-4600	94	1.188	2.441	0.375	30	62	10	21432-2448	142-L	16.750	17.875	1.250	425	454	32
27223-5074	94	2.953	4.528	0.375	75	115	10	21432-2512	142-L	15.250	16.375	1.250	387	416	32
27223-5091	94	1.375	2.441	0.313	35	62	8	21432-2591	142-L	26.750	27.750	0.750	679	705	19
27223-5937	94	0.969	2.048	0.375	25	52	10	21432-2592	142-L	27.000	28.000	0.750	686	711	19
27223-6074	94	0.500	0.875	0.234	13	22	6	21432-2593	142-L	26.437	27.437	0.750	671	697	19
27223-6120	94	0.750	1.851	0.375	19	47	10	21432-2594	142-L	26.500	27.500	0.750	673	699	19
27223-6176	94	1.125	2.441	0.375	29	62	10	21432-2986	142	12.000	13.125	1.313	305	333	33
27223-6192	94	1.250	2.835	0.375	32	72	10	21432-3099	142-L	14.000	15.125	1.375	356	384	35
27223-6208	94	1.375	1.875	0.313	35	48	8	21432-3509	142	7.875	8.875	0.750	200	225	19
27223-6211	94	1.438	1.938	0.250	37	49	6	21432-3511	142	11.438	12.438	0.750	291	316	19
27223-6266	94	1.938	3.544	0.375	49	90	10	21432-3545	142	7.500	8.500	0.750	191	216	19
27223-6300	94	2.563	3.938	0.375	65	100	10	21432-3593	142	8.000	9.000	0.750	203	229	19
27223-6314	94	3.344	5.118	0.500	85	130	13	21432-3615	142	9.000	10.000	0.750	229	254	19
27223-6323	94	3.938	5.906	0.500	100	150	13	21432-3628	142	9.250	10.250	0.750	235	260	19
27223-6329	94	5.063	7.875	0.500	129	200	13	21432-3668	142	10.000	11.000	0.750	254	279	19
27223-6486	94	1.563	3.544	0.375	40	90	10	21432-3804	142-L	21.000	22.125	1.250	533	562	32
27223-6557	94	1.375	3.150	0.375	35	80	10	21432-4141	142-L	24.213	25.713	1.000	615	653	25
27223-6639	94	1.375	2.835	0.313	35	72	8	21432-4146	142-L	33.386	35.386	1.500	848	899	38
27223-6738	94	1.156	2.835	0.375	29	72	10	21432-4266	142-L	21.375	22.500	1.250	543	572	32
27223-7021	94	0.625	1.000	0.250	16	25	6	21432-4463	142	7.938	8.938	0.750	202	227	19
27223-7033	94	0.750	1.250	0.250	19	32	6	21432-4483	142	8.250	9.250	0.750	210	235	19

All dimensions are in inches. Preferred sizes are indicated with **bold** type face.

Sizes listed are for standard nitrile elements, except Models 25 and 62 which have PTFE elements. Other material available on inquiry only.

## Oil Seals by Model Number

Product Code	Model	Inches			MM			Product Code	Model	Inches			MM		
		ID	OD	Width	ID	OD	Width			ID	OD	Width	ID	OD	Width
21432-4543	142-L	24.250	25.250	0.750	616	641	19	21432-9220	142-L	31.750	33.750	1.250	806	857	32
21432-4547	142-L	32.500	34.500	1.500	826	876	38	21432-9229	142-L	49.000	51.000	1.250	1245	1295	32
21432-4696	142-L	29.250	30.250	0.750	743	768	19	21432-9235	142-L	51.500	53.500	1.250	1308	1359	32
21432-4753	142-L	15.375	16.500	1.250	391	419	32	21432-9318	142-L	26.000	27.125	1.375	660	689	35
21432-4829	142-L	36.000	38.000	1.500	914	965	38	21432-9319	142-L	27.250	28.375	1.375	692	721	35
21432-4859	142-L	21.750	23.250	1.000	552	591	25	21432-9336	142-L	24.000	25.000	0.750	610	635	19
21432-4896	142-L	37.875	39.875	1.250	962	1013	32	21432-9343	142-L	47.500	49.500	1.500	1207	1257	38
21432-4918	142-L	29.500	31.000	1.000	749	787	25	21432-9393	142-L	24.875	26.375	1.000	632	670	25
21432-4928	142-L	29.950	30.950	0.750	761	786	19	21432-9498	142-L	24.250	25.375	1.250	616	645	32
21432-4964	142-L	40.125	42.125	1.500	1019	1070	38	21432-9550	142-L	31.500	33.500	1.250	800	851	32
21432-5147	142-L	18.000	19.125	1.250	457	486	32	21432-9552	142-L	22.875	24.000	1.313	581	610	33
21432-5218	142-L	32.500	34.500	1.250	826	876	32	21432-9579	142-L	47.500	49.500	1.250	1207	1257	32
21432-5272	142-L	28.250	29.750	1.000	718	756	25	21432-9605	142-L	58.550	60.550	1.250	1487	1538	32
21432-5422	142-L	67.750	69.750	1.250	1721	1772	32	21432-9627	142-L	63.650	65.650	1.250	1617	1668	32
21432-5440	142-L	24.000	25.500	1.000	610	648	25	21432-9638	142-L	39.500	41.500	1.250	1003	1054	32
21432-5471	142-L	55.750	56.750	0.750	1416	1441	19	21432-9650	142-L	41.500	43.000	1.000	1054	1092	25
21432-5529	142-L	75.750	77.750	1.250	1924	1975	32	21432-9663	142-L	37.250	38.375	1.250	946	975	32
21432-5588	142-L	31.000	33.000	1.250	787	838	32	21432-9685	142-L	23.750	24.875	1.250	603	632	32
21432-5762	142-L	39.000	41.000	1.250	991	1041	32	21432-9698	142-L	21.500	22.625	1.250	546	575	32
21432-5870	142-L	24.000	25.125	1.250	610	638	32	21432-9699	142-L	25.000	26.500	1.000	635	673	25
21432-5871	142-L	29.250	30.750	1.000	743	781	25	21432-9707	142	12.000	13.125	1.250	305	333	32
21432-5924	142-L	47.500	49.500	1.375	1207	1257	35	21432-9730	142-L	28.000	29.500	1.000	711	749	25
21432-6430	142-L	15.750	16.875	1.250	400	429	32	21432-9745	142-L	41.000	43.000	1.250	1041	1092	32
21432-6458	142-L	24.250	25.750	1.000	616	654	25	21432-9794	142-L	47.000	49.000	1.500	1194	1245	38
21432-6737	142-L	18.500	19.625	1.250	470	498	32	21432-9813	142-L	33.875	35.000	1.250	860	889	32
21432-6796	142-L	22.000	23.500	1.000	559	597	25	21432-9814	142-L	29.875	31.000	1.250	759	787	32
21432-6931	142	10.250	11.250	0.750	260	286	19	21432-9832	142-L	28.000	29.125	1.250	711	740	32
21432-6997	142-L	41.500	43.500	1.250	1054	1105	32	21432-9872	142-L	22.000	23.125	1.250	559	587	32
21432-7422	142-L	24.213	25.213	0.750	615	640	19	21432-9873	142-L	21.500	23.000	1.000	546	584	25
21432-7445	142	12.000	13.125	1.375	305	333	35	21432-9885	142-L	63.622	65.622	1.250	1616	1667	32
21432-7479	142-L	41.500	43.500	1.500	1054	1105	38	21432-9886	142-L	46.500	48.500	1.250	1181	1232	32
21432-7605	142-L	40.500	42.500	1.500	1029	1080	38	21432-9891	142-L	58.110	60.110	1.250	1476	1527	32
21432-7607	142-L	18.750	20.250	1.000	476	514	25	21432-9909	142-L	23.500	24.625	1.375	597	625	35
21432-7615	142-L	18.000	19.500	1.000	457	495	25	21432-9923	142-L	55.000	57.000	1.250	1397	1448	32
21432-7681	142-L	25.125	26.250	1.250	638	667	32	21432-9946	142-L	42.000	43.500	1.000	1067	1105	25
21432-7685	142-L	26.299	27.795	1.000	668	706	25	21443-0611	142-L	16.750	17.750	0.750	425	451	19
21432-7706	142-L	20.000	21.125	1.250	508	537	32	21443-0689	142-L	29.750	31.750	1.500	756	806	38
21432-7729	142-L	13.000	14.125	1.250	330	359	32	21443-0792	142-L	16.688	17.688	0.750	424	449	19
21432-7885	142-L	22.750	23.875	1.375	578	606	35	21443-0812	142-L	13.000	14.125	1.375	330	359	35
21432-7886	142-L	16.750	17.875	1.312	425	454	33	21443-0863	142-L	25.375	26.500	1.250	645	673	32
21432-8106	142-L	13.750	14.750	0.750	349	375	19	21443-1243	142	8.228	9.228	0.750	209	234	19
21432-8107	142	12.000	13.000	0.750	305	330	19	21443-1244	142	12.204	13.204	0.750	310	335	19
21432-8113	142-L	32.000	34.000	1.250	813	864	32	21443-2338	142-L	14.500	15.500	0.750	368	394	19
21432-8277	142-L	27.000	28.125	1.375	686	714	35	21443-3028	142-L	60.375	62.375	1.250	1534	1584	32
21432-8390	142-L	25.125	26.250	1.375	638	667	35	21443-3116	142-L	115.500	117.000	1.000	2934	2972	25
21432-8395	142-L	43.500	45.500	1.500	1105	1156	38	21443-3539	142-L	18.000	19.000	0.750	457	483	19
21432-8440	142-L	18.250	19.375	1.250	464	492	32	21443-3593	142	8.000	9.000	0.750	203	229	19
21432-8547	142-L	25.500	27.000	1.000	648	686	25	21443-3628	142	9.250	10.250	0.750	235	260	19
21432-8553	142	9.844	10.844	0.750	250	275	19	21443-3668	142	10.000	11.000	0.750	254	279	19
21432-8556	142-L	16.250	17.250	0.750	413	438	19	21443-3746	142-L	57.500	59.500	1.250	1461	1511	32
21432-8561	142-L	28.000	29.125	1.375	711	740	35	21443-4483	142	8.250	9.250	0.750	210	235	19
21432-8566	142-L	25.000	26.125	1.375	635	664	35	21443-4937	142	9.500	10.500	0.750	241	267	19
21432-8568	142-L	48.000	50.000	1.250	1219	1270	32	21443-5375	142-L	14.000	15.125	1.375	356	384	35
21432-8651	142-L	31.750	33.750	1.500	806	857	38	21443-5376	142-L	14.500	15.625	1.375	368	397	35
21432-8672	142-L	51.500	53.500	1.500	1308	1359	38	21443-6519	142-L	14.000	15.000	0.750	356	381	19
21432-9183	142-L	26.000	27.500	1.000	660	699	25	21443-7536	142-L	16.000	17.000	0.750	406	432	19

All dimensions are in inches. Preferred sizes are indicated with **bold** type face.  
 Sizes listed are for standard nitrile elements, except Models 25 and 62 which have PTFE elements. Other material available on inquiry only.

## Oil Seals by Model Number

Product Code	Model	Inches			MM			Product Code	Model	Inches			MM		
		ID	OD	Width	ID	OD	Width			ID	OD	Width	ID	OD	Width
21443-8553	142	9.843	10.843	0.750	250	275	19	21335-2748	143	35.905	37.217	0.781	912	945	20
21443-9650	142-L	41.500	43.000	1.000	1054	1092	25	21335-3418	143	7.875	9.187	0.781	200	233	20
21443-9707	142	12.000	13.125	1.250	305	333	32	21335-4035	143	24.441	25.753	0.781	621	654	20
21443-9872	142-L	22.000	23.125	1.250	559	587	32	21335-4227	143	7.490	8.802	0.781	190	224	20
21443-9905	142-L	94.000	96.000	1.500	2388	2438	38	21339-3173	143	13.000	17.062	2.000	330	433	51
21443-9946	142-L	42.000	43.500	1.000	1067	1105	25	21339-3175	143	13.976	18.038	2.000	355	458	51
21332-2051	143	2.125	2.725	0.510	54	69	13	21339-3189	143	14.250	18.312	2.000	362	465	51
21332-2053	143	1.875	2.475	0.510	48	63	13	21340-3291	143	26.737	30.799	2.000	679	782	51
21332-2413	143	5.500	6.450	0.810	140	164	21	21340-3403	143	17.750	21.812	2.000	451	554	51
21332-2559	143	30.000	32.000	1.500	762	813	38	21340-3437	143	15.250	19.312	2.000	387	491	51
21332-2585	143	9.312	10.625	0.781	237	270	20	21340-3743	143	41.125	45.187	2.000	1045	1148	51
21332-2586	143	10.000	11.312	0.781	254	287	20	21340-3798	143	33.025	37.087	2.000	839	942	51
21332-2749	143	3.430	4.130	0.610	87	105	15	21340-3799	143	35.075	39.137	2.000	891	994	51
21332-2787	143	16.000	17.312	0.781	406	440	20	21340-3805	143	33.000	37.062	2.000	838	941	51
21332-7265	143	30.000	32.000	1.250	762	813	32	21340-3936	143	33.125	37.187	2.000	841	945	51
21332-9931	143	37.205	38.205	0.750	945	970	19	21340-4528	143	22.500	26.562	2.000	572	675	51
21333-2097	143	20.213	21.525	0.781	513	547	20	24643-7832	26E-L	11.250	12.750	0.625	286	324	16
21333-2100	143	26.738	28.050	0.781	679	712	20	24656-0516	26HR-L	32.000	34.000	0.875	813	864	22
21333-2190	143	7.625	8.937	0.781	194	227	20	24656-3909	26HR-L	12.500	14.400	0.750	318	366	19
21333-2194	143	41.380	42.692	0.781	1051	1084	20	24660-2236	26HR	4.125	5.234	0.305	105	133	8
21333-2431	143	36.220	37.532	0.781	920	953	20	24660-2263	26HR	3.250	4.000	0.375	83	102	10
21333-2473	143	15.500	16.812	0.781	394	427	20	24660-3329	26HR	6.693	8.268	0.630	170	210	16
21333-2529	143	9.094	10.406	0.781	231	264	20	24660-3373	26HR	6.000	7.625	0.625	152	194	16
21333-2695	143	6.630	7.942	0.781	168	202	20	24660-7059	26HR-L	18.500	20.500	0.750	470	521	19
21333-2805	143	9.812	11.124	0.781	249	283	20	24662-3500	26HR	7.000	8.500	0.625	178	216	16
21333-2806	143	24.500	25.812	0.781	622	656	20	24662-5566	26HR	3.713	4.972	0.492	94	126	12
21333-2817	143	13.000	14.312	0.781	330	364	20	24663-3230	26HR-L	17.500	19.500	0.750	445	495	19
21333-2979	143	12.500	13.812	0.781	318	351	20	24664-5387	26HR	3.375	4.500	0.438	86	114	11
21333-3022	143	5.000	6.312	0.781	127	160	20	24664-5388	26HR	4.000	5.125	0.438	102	130	11
21333-3048	143	62.000	63.312	0.781	1575	1608	20	24670-5464	26HR-L	17.717	20.079	.984	450	510	25
21333-3232	143	15.748	17.060	0.781	400	433	20	24685-0782	26HR-L	17.000	19.000	1.000	432	483	25
21333-3266	143	37.240	38.552	0.781	946	979	20	24635-2988	26NS	5.118	6.299	0.590	130	160	15
21333-3299	143	8.661	9.973	0.781	220	253	20	24635-3136	26NS-L	7.750	10.250	0.500	197	260	13
21333-3399	143	9.843	11.155	0.781	250	283	20	24635-3665	26NS-L	10.500	11.750	0.625	267	298	16
21333-3407	143	15.250	16.562	0.781	387	421	20	24650-0556	26NS	1.375	2.500	0.375	35	64	10
21333-3443	143	7.750	9.062	0.781	197	230	20	24650-0631	26NS	1.250	2.250	0.500	32	57	13
21333-3451	143	20.500	21.812	0.781	521	554	20	24650-0758	26NS	1.625	2.188	0.375	41	56	10
21333-3475	143	11.750	13.062	0.781	298	332	20	24650-0834	26NS	1.688	2.502	0.375	43	64	10
21333-3505	143	21.000	22.312	0.781	533	567	20	24650-1111	26NS	1.938	2.500	0.375	49	64	10
21333-3651	143	31.750	33.062	0.781	806	840	20	24650-2225	26NS	3.125	4.125	0.500	79	105	13
21333-3656	143	41.125	42.437	0.781	1045	1078	20	24650-2478	26NS	3.750	5.000	0.500	95	127	13
21333-3729	143	10.750	12.062	0.781	273	306	20	24650-3885	26NS	1.125	2.750	0.375	29	70	10
21333-3802	143	35.075	36.387	0.781	891	924	20	24650-3913	26NS	6.299	7.480	0.630	160	190	16
21333-4070	143	35.500	36.812	0.781	902	935	20	24650-3955	26NS-L	9.055	10.236	0.591	230	260	15
21333-4353	143	19.000	20.312	0.781	483	516	20	24650-5331	26NS	7.000	7.864	0.500	178	200	13
21333-4380	143	26.800	28.112	0.781	681	714	20	24650-5335	26NS	5.906	7.087	0.551	150	180	14
21333-4391	143	11.811	13.123	0.787	300	333	20	24650-5429	26NS-L	10.236	11.811	0.787	260	300	20
21333-4554	143	19.880	21.192	0.781	505	538	20	24650-9960	26NS	4.250	5.250	0.438	108	133	11
21333-4755	143	52.600	53.912	0.781	1336	1369	20	24652-1204	26NS	2.000	3.000	0.375	51	76	10
21334-2187	143	7.060	8.372	0.781	179	213	20	24652-2915	26NS	5.000	6.000	0.500	127	152	13
21334-2190	143	7.625	8.937	0.781	194	227	20	24606-1859	26R1	2.559	3.465	0.472	65	88	12
21334-2898	143	11.417	12.729	0.781	290	323	20	24606-3065	26R1	5.250	6.500	0.500	133	165	13
21334-2899	143	13.780	15.092	0.781	350	383	20	24606-3370	26R1	6.000	7.500	0.750	152	191	19
21334-3561	143	18.000	19.312	0.781	457	491	20	24608-0279	26R1-L	16.000	18.000	0.750	406	457	19
21334-3841	143	26.000	27.312	0.781	660	694	20	24608-0678	26R1	6.250	7.250	0.500	159	184	13
21335-2473	143	15.500	16.812	0.781	394	427	20	24608-2432	26R1	3.625	5.250	0.500	92	133	13

All dimensions are in inches. Preferred sizes are indicated with **bold** type face.

Sizes listed are for standard nitrile elements, except Models 25 and 62 which have PTFE elements. Other material available on inquiry only.

## Oil Seals by Model Number

Product Code	Model	Inches			MM			Product Code	Model	Inches			MM		
		ID	OD	Width	ID	OD	Width			ID	OD	Width	ID	OD	Width
24608-2703	26R1	4.331	5.512	0.551	110	140	14	24620-1857	26R1	2.375	3.372	0.438	60	86	11
24608-2731	26R1	4.331	5.512	0.512	110	140	13	24620-1859	26R1	2.559	3.465	0.472	65	88	12
24608-3233	26R1-L	15.250	16.625	0.531	387	422	13	24620-1953	26R1	1.969	3.543	0.394	50	90	10
24608-3606	26R1	8.250	9.500	0.625	210	241	16	24620-2026	26R1	2.756	3.346	0.315	70	85	8
24608-3708	26R1-L	12.000	13.500	0.653	305	343	17	24620-2027	26R1	2.756	3.622	0.472	70	92	12
24608-4052	26R1-L	11.811	13.386	0.787	300	340	20	24620-2034	26R1	4.331	5.118	0.472	110	130	12
24608-5276	26R1-L	16.750	18.750	0.750	425	476	19	24620-2035	26R1	2.750	3.500	0.375	70	89	10
24608-5347	26R1	5.709	6.890	0.551	145	175	14	24620-2037	26R1	2.750	3.500	0.500	70	89	13
24608-5357	26R1	8.661	9.843	0.591	220	250	15	24620-2054	26R1	2.750	3.625	0.438	70	92	11
24608-5359	26R1-L	9.449	10.630	0.591	240	270	15	24620-2058	26R1	2.751	3.750	0.438	70	95	11
24608-6232	26R1	3.938	4.724	0.472	100	120	12	24620-2122	26R1	2.156	4.725	0.375	55	120	10
24608-6386	26R1-L	8.750	10.000	0.625	222	254	16	24620-2177	26R1	3.000	4.125	0.500	76	105	13
24608-7388	26R1	7.874	9.055	0.590	200	230	15	24620-2187	26R1	3.000	4.125	0.438	76	105	11
24619-0979	26R1-L	15.551	17.283	0.740	395	439	19	24620-2215	26R1	3.150	4.134	0.512	80	105	13
24619-7268	26R1	6.693	7.874	0.591	170	200	15	24620-2216	26R1	3.125	4.249	0.438	79	108	11
24619-7807	26R1	7.087	8.268	0.591	180	210	15	24620-2432	26R1	3.625	5.250	0.500	92	133	13
24620-0041	26R1-L	9.250	10.500	0.625	235	267	16	24620-2437	26R1	3.543	4.331	0.472	90	110	12
24620-0044	26R1-L	9.250	11.250	0.750	235	286	19	24620-2494	26R1	3.938	4.881	0.625	100	124	16
24620-0280	26R1	0.984	1.496	0.276	25	38	7	24620-2554	26R1	4.000	4.875	0.500	102	124	13
24620-0379	26R1	1.181	1.969	0.433	30	50	11	24620-2621	26R1	1.969	4.331	0.375	50	110	10
24620-0572	26R1	1.378	1.969	0.315	35	50	8	24620-2669	26R1	3.188	5.000	0.438	81	127	11
24620-0664	26R1	4.875	5.875	0.500	124	149	13	24620-2703	26R1	4.331	5.512	0.551	110	140	14
24620-0678	26R1	6.250	7.250	0.500	159	184	13	24620-2731	26R1	4.331	5.512	0.512	110	140	13
24620-0729	26R1	1.575	2.441	0.433	40	62	11	24620-2753	26R1	4.500	5.500	0.500	114	140	13
24620-0760	26R1	1.625	2.375	0.375	41	60	10	24620-2779	26R1	4.528	5.512	0.472	115	140	12
24620-0896	26R1	1.750	2.750	0.313	44	70	8	24620-2798	26R1	4.625	5.625	0.500	117	143	13
24620-0909	26R1	1.750	2.625	0.500	44	67	13	24620-2809	26R1	4.625	6.000	0.625	117	152	16
24620-0935	26R1	1.772	2.441	0.315	45	62	8	24620-2841	26R1	4.750	5.500	0.375	121	140	10
24620-0963	26R1	5.500	7.000	0.500	140	178	13	24620-2862	26R1	3.500	4.721	0.375	89	120	10
24620-0979	26R1-L	15.551	17.283	0.740	395	439	19	24620-2863	26R1	4.724	5.906	0.512	120	150	13
24620-1030	26R1	1.575	2.559	0.473	40	65	12	24620-2890	26R1	4.921	6.693	0.472	125	170	12
24620-1031	26R1	2.362	3.543	0.551	60	90	14	24620-2908	26R1	2.953	4.528	0.472	75	115	12
24620-1033	26R1	3.150	3.937	0.394	80	100	10	24620-2915	26R1	5.000	6.000	0.500	127	152	13
24620-1034	26R1	4.134	5.315	0.551	105	135	14	24620-2921	26R1	5.000	6.250	0.500	127	159	13
24620-1036	26R1	7.480	8.858	0.630	190	225	16	24620-2923	26R1	5.000	6.250	0.625	127	159	16
24620-1037	26R1-L	11.811	13.583	0.866	300	345	22	24620-2965	26R1-L	10.630	12.205	0.787	270	310	20
24620-1079	26R1	1.890	2.750	0.470	48	70	12	24620-2989	26R1	5.118	6.299	0.551	130	160	14
24620-1107	26R1	1.969	2.835	0.472	50	72	12	24620-3026	26R1	5.188	6.250	0.500	132	159	13
24620-1108	26R1	1.969	2.677	0.354	50	68	9	24620-3065	26R1	5.250	6.500	0.500	133	165	13
24620-1109	26R1	1.938	3.548	0.375	49	90	10	24620-3118	26R1	5.315	6.693	0.591	135	170	15
24620-1189	26R1	2.000	2.750	0.375	51	70	10	24620-3122	26R1	5.375	6.375	0.500	137	162	13
24620-1201	26R1	2.000	2.997	0.375	51	76	10	24620-3186	26R1	5.500	6.632	0.500	140	168	13
24620-1258	26R1	2.062	3.000	0.375	52	76	10	24620-3193	26R1	5.500	7.000	0.828	140	178	21
24620-1321	26R1	2.125	2.878	0.375	54	73	10	24620-3201	26R1	5.512	6.299	0.512	140	160	13
24620-1355	26R1	2.125	3.545	0.438	54	90	11	24620-3232	26R1	5.625	6.625	0.375	143	168	10
24620-1369	26R1	2.165	2.835	0.315	55	72	8	24620-3308	26R1	1.938	3.250	0.375	49	83	10
24620-1370	26R1	2.165	3.071	0.472	55	78	12	24620-3352	26R1	6.102	7.087	0.591	155	180	15
24620-1371	26R1	2.165	3.071	0.354	55	78	9	24620-3354	26R1	6.000	7.000	0.438	152	178	11
24620-1575	26R1	2.313	3.250	0.500	59	83	13	24620-3377	26R1	6.125	7.125	0.625	156	181	16
24620-1605	26R1	2.363	2.953	0.315	60	75	8	24620-3419	26R1	4.528	5.709	0.787	115	145	20
24620-1606	26R1	2.362	3.228	0.472	60	82	12	24620-3434	26R1	6.500	8.000	0.625	165	203	16
24620-1642	26R1	2.375	3.125	0.375	60	79	10	24620-3459	26R1	2.531	4.725	0.375	64	120	10
24620-1686	26R1	2.500	3.125	0.313	64	79	8	24620-3515	26R1	7.125	8.625	0.750	181	219	19
24620-1726	26R1	2.437	3.147	0.375	62	80	10	24620-3518	26R1	7.250	8.250	0.625	184	210	16
24620-1735	26R1	2.437	3.250	0.375	62	83	10	24620-3542	26R1	4.500	7.000	0.531	114	178	13
24620-1819	26R1	2.500	3.500	0.375	64	89	10	24620-3693	26R1-L	11.000	12.500	0.625	279	318	16

All dimensions are in inches. Preferred sizes are indicated with **bold** type face. Sizes listed are for standard nitrile elements, except Models 25 and 62 which have PTFE elements. Other material available on inquiry only.



## Oil Seals by Model Number

Product Code	Model	Inches			MM			Product Code	Model	Inches			MM		
		ID	OD	Width	ID	OD	Width			ID	OD	Width	ID	OD	Width
24620-3712	26R1	0.945	1.929	0.472	24	49	12	24620-8196	26R1-L	14.567	16.142	0.787	370	410	20
24620-3715	26R1	1.949	3.031	0.709	50	77	18	24620-9030	26R1	3.938	4.724	0.511	100	120	13
24620-3886	26R1-L	11.417	12.992	0.787	290	330	20	24620-9190	26R1	3.740	4.724	0.472	95	120	12
24620-3914	26R1	7.874	9.055	0.551	200	230	14	24620-9708	26R1	4.375	5.375	0.688	111	137	17
24620-3916	26R1	7.874	9.449	0.787	200	240	20	24622-0788	26R1	1.500	2.375	0.500	38	60	13
24620-3923	26R1	7.441	8.858	0.630	189	225	16	24622-1033	26R1	3.150	3.937	0.394	80	100	10
24620-3944	26R1-L	8.661	10.236	0.866	220	260	22	24622-1106	26R1	1.969	2.441	0.276	50	62	7
24620-3956	26R1-L	9.055	10.591	0.866	230	269	22	24622-1108	26R1	1.969	2.677	0.354	50	68	9
24620-3974	26R1-L	9.449	11.417	0.748	240	290	19	24622-1604	26R1	2.362	3.150	0.276	60	80	7
24620-3987	26R1	2.500	3.750	0.688	64	95	17	24622-1819	26R1	2.500	3.500	0.375	64	89	10
24620-4006	26R1-L	10.500	12.500	0.625	267	318	16	24622-2066	26R1	2.750	3.876	0.468	70	98	12
24620-4008	26R1-L	10.250	12.250	0.625	260	311	16	24622-2279	26R1	3.250	4.625	0.500	83	117	13
24620-4020	26R1	2.375	3.543	0.438	60	90	11	24622-2526	26R1	3.938	5.188	0.512	100	132	13
24620-4021	26R1	2.875	3.751	0.250	73	95	6	24622-2603	26R1	4.125	5.250	0.500	105	133	13
24620-4071	26R1-L	12.000	14.000	0.750	305	356	19	24622-2703	26R1	4.331	5.512	0.551	110	140	14
24620-4129	26R1-L	14.000	15.500	1.000	356	394	25	24622-2779	26R1	4.528	5.512	0.472	115	140	12
24620-4155	26R1-L	15.000	17.000	0.750	381	432	19	24622-3355	26R1	6.000	7.000	0.500	152	178	13
24620-4228	26R1	1.500	3.250	0.500	38	83	13	24622-3435	26R1	6.500	8.000	0.750	165	203	19
24620-4269	26R1-L	22.000	23.500	0.750	559	597	19	24622-3663	26R1	2.953	3.740	0.512	75	95	13
24620-4549	26R1	1.188	2.835	0.375	30	72	10	24622-3937	26R1-L	8.500	10.000	0.750	216	254	19
24620-4620	26R1	1.188	2.441	0.375	30	62	10	24622-4133	26R1	3.125	4.000	0.500	79	102	13
24620-4654	26R1	3.750	4.999	0.500	95	127	13	24622-4258	26R1	2.362	3.071	0.354	60	78	9
24620-5010	26R1	5.500	7.000	0.750	140	178	19	24622-4259	26R1	2.756	3.346	0.354	70	85	9
24620-5018	26R1-L	11.000	12.250	0.609	279	311	15	24622-4260	26R1	2.166	2.835	0.355	55	72	9
24620-5335	26R1	5.906	7.087	0.551	150	180	14	24622-4261	26R1	2.756	3.544	0.433	70	90	11
24620-5338	26R1	8.267	9.449	0.590	210	240	15	24622-4382	26R1	4.724	5.906	0.472	120	150	12
24620-5339	26R1-L	9.843	11.024	0.591	250	280	15	24622-4437	26R1	3.937	4.725	0.433	100	120	11
24620-5344	26R1	3.543	4.527	0.512	90	115	13	24622-5343	26R1	3.346	4.331	0.512	85	110	13
24620-5345	26R1	3.937	4.921	0.512	100	125	13	24622-6450	26R1	6.250	7.250	0.438	159	184	11
24620-5349	26R1	5.709	6.890	0.551	145	175	14	24628-7388	26R1	7.874	9.055	0.591	200	230	15
24620-5354	26R1	4.921	6.102	0.551	125	155	14	24629-0379	26R1	1.181	1.968	0.434	30	50	11
24620-5357	26R1	8.661	9.842	0.590	220	250	15	24629-0572	26R1	1.378	1.969	0.315	35	50	8
24620-5400	26R1	4.134	5.118	0.591	105	130	15	24629-0760	26R1	1.625	2.375	0.375	41	60	10
24620-5426	26R1	2.250	3.876	0.468	57	98	12	24629-1031	26R1	2.362	3.543	0.551	60	90	14
24620-5451	26R1	1.895	2.700	0.500	48	69	13	24629-1033	26R1	3.153	3.937	0.394	80	100	10
24620-5456	26R1-L	13.500	15.000	0.653	343	381	17	24629-1034	26R1	4.134	5.315	0.551	105	135	14
24620-5465	26R1-L	10.750	12.750	0.625	273	324	16	24629-1036	26R1	7.480	8.858	0.630	190	225	16
24620-5466	26R1-L	14.961	17.323	0.984	380	440	25	24629-1108	26R1	1.969	2.677	0.354	50	68	9
24620-5758	26R1	2.500	3.875	0.468	64	98	12	24629-1369	26R1	2.165	2.835	0.315	55	72	8
24620-5844	26R1	1.875	2.625	0.313	48	67	8	24629-1370	26R1	2.165	3.071	0.472	55	78	12
24620-6061	26R1	3.740	4.724	0.512	95	120	13	24629-1371	26R1	2.165	3.070	0.354	55	78	9
24620-6117	26R1-L	15.000	17.000	1.250	381	432	32	24629-1575	26R1	2.312	3.250	0.500	59	83	13
24620-6370	26R1	6.500	8.000	0.500	165	203	13	24629-1605	26R1	2.362	2.953	0.315	60	75	8
24620-6374	26R1	7.000	8.000	0.500	178	203	13	24629-1606	26R1	2.362	3.228	0.472	60	82	12
24620-6709	26R1	3.938	4.938	0.375	100	125	10	24629-1642	26R1	2.375	3.125	0.375	60	79	10
24620-7059	26R1-L	18.500	20.500	0.750	470	521	19	24629-1859	26R1	2.559	3.465	0.472	65	88	12
24620-7164	26R1	1.875	2.835	0.375	48	72	10	24629-2035	26R1	2.750	3.500	0.375	70	89	10
24620-7268	26R1	6.693	7.874	0.591	170	200	15	24629-2437	26R1	3.543	4.330	0.472	90	110	12
24620-7276	26R1	6.299	7.480	0.591	160	190	15	24629-2731	26R1	4.331	5.512	0.512	110	140	13
24620-7277	26R1	4.724	5.906	0.591	120	150	15	24629-2779	26R1	4.528	5.512	0.472	115	140	12
24620-7383	26R1	5.512	6.693	0.551	140	170	14	24629-2894	26R1	4.938	6.000	0.500	125	152	13
24620-7388	26R1	7.874	9.055	0.591	200	230	15	24629-2989	26R1	5.118	6.299	0.551	130	160	14
24620-7394	26R1	3.346	4.724	0.472	85	120	12	24629-3065	26R1	5.250	6.500	0.500	133	165	13
24620-7396	26R1	4.331	5.512	0.472	110	140	12	24629-3354	26R1	6.000	7.000	0.437	152	178	11
24620-7654	26R1	1.969	2.559	0.354	50	65	9	24629-3436	26R1	6.625	7.625	0.625	168	194	16
24620-7807	26R1	7.087	8.268	0.591	180	210	15	24629-3459	26R1	2.531	4.725	0.375	64	120	10

All dimensions are in inches. Preferred sizes are indicated with **bold** type face.

Sizes listed are for standard nitrile elements, except Models 25 and 62 which have PTFE elements. Other material available on inquiry only.

## Oil Seals by Model Number

Product Code	Model	Inches			MM			Product Code	Model	Inches			MM		
		ID	OD	Width	ID	OD	Width			ID	OD	Width	ID	OD	Width
24629-3914	26R1	7.874	9.055	0.551	200	230	14	22987-6920	53F1	6.500	7.500	0.844	165	191	21
24629-3916	26R1	7.874	9.449	0.787	200	240	20	22987-6990	53F1	4.000	5.000	0.719	102	127	18
24629-4717	26R1	1.575	2.165	0.315	40	55	8	22987-7002	53F1	5.625	7.500	0.719	143	191	18
24629-5335	26R1	5.906	7.087	0.552	150	180	14	22987-7115	53F1	3.500	4.500	0.719	89	114	18
24629-5338	26R1	8.267	9.448	0.590	210	240	15	22987-7232	53F1	4.313	6.375	0.781	110	162	20
24629-5345	26R1	3.937	4.921	0.512	100	125	13	22987-7233	53F1	7.500	9.000	0.844	191	229	21
24629-5349	26R1	5.708	6.889	0.551	145	175	14	22987-7241	53F1	7.750	9.250	0.844	197	235	21
24629-5354	26R1	4.921	6.102	0.552	125	155	14	22987-7289	53F1	3.375	4.500	0.719	86	114	18
24629-5357	26R1	8.661	9.842	0.590	220	250	15	22987-7392	53F1-L	12.000	14.000	1.250	305	356	32
24629-5433	26R1	6.496	7.678	0.709	165	195	18	22987-7433	53F1	6.000	7.500	0.906	152	191	23
24629-6370	26R1	6.500	8.000	0.500	165	203	13	22987-7436	53F1	6.750	8.000	0.719	171	203	18
24629-7268	26R1	6.693	7.874	0.591	170	200	15	22987-7448	53F1	4.000	5.500	0.719	102	140	18
24629-7383	26R1	5.512	6.693	0.551	140	170	14	22987-7572	53F1	6.750	8.250	0.781	171	210	20
24629-7388	26R1	7.874	9.055	0.591	200	230	15	22987-7585	53F1	10.625	12.500	1.000	270	318	25
24629-7396	26R1	4.331	5.511	0.472	110	140	12	22987-7670	53F1	3.250	4.249	0.750	83	108	19
24629-7654	26R1	1.969	2.559	0.354	50	65	9	22987-7880	53F1	4.250	5.250	0.781	108	133	20
24629-7807	26R1	7.087	8.268	0.591	180	210	15	22987-7909	53F1	9.500	11.500	1.250	241	292	32
24629-9030	26R1	3.938	4.724	0.511	100	120	13	22987-8149	53F1	6.500	7.500	0.781	165	191	20
24629-9190	26R1	3.740	4.724	0.472	95	120	12	22987-8182	53F1	8.750	10.000	1.000	222	254	25
24629-9708	26R1	4.375	5.375	0.687	111	137	17	22987-8471	53F1	5.625	6.875	0.719	143	175	18
24648-0041	26R1-L	9.250	10.500	0.625	235	267	16	22987-8531	53F1	3.688	5.250	0.781	94	133	20
24648-0932	26R1	4.125	5.500	0.500	105	140	13	22987-8717	53F1	9.500	10.500	1.000	241	267	25
24648-2572	26R1-L	11.750	13.750	0.750	298	349	19	22987-8729	53F1	8.250	9.500	0.844	210	241	21
24648-4006	26R1-L	10.500	12.500	0.625	267	318	16	22987-9347	53F1	4.625	6.000	0.719	117	152	18
24651-5357	26R1	8.661	9.842	0.590	220	250	15	22987-9584	53F1	7.500	9.000	0.719	191	229	18
22987-0238	53F1	3.313	4.500	0.719	84	114	18	22987-9708	53F1	4.375	5.375	0.719	111	137	18
22987-3890	53F1-L	13.000	14.500	1.000	330	368	25	22500-2569	53G1	4.000	6.250	0.625	102	159	16
22987-4853	53F1	6.875	7.875	0.969	175	200	25	22500-2595	53G1	3.437	4.500	0.625	87	114	16
22987-4978	53F1	7.938	9.125	0.969	202	232	25	22500-2755	53G1	4.500	5.500	0.625	114	140	16
22987-4995	53F1	11.375	13.500	1.250	289	343	32	22500-2839	53G1	4.750	5.750	0.625	121	146	16
22987-5027	53F1	5.437	6.875	0.969	138	175	25	22500-3046	53G1	5.188	6.250	0.625	132	159	16
22987-5171	53F1	5.250	6.500	0.719	133	165	18	22500-3178	53G1	5.500	6.500	0.625	140	165	16
22987-5201	53F1	3.875	4.875	0.719	98	124	18	22500-3181	53G1	5.500	6.625	0.625	140	168	16
22987-5205	53F1	9.750	11.250	1.000	248	286	25	22500-3233	53G1	5.625	6.750	0.625	143	171	16
22987-5211	53F1	6.500	8.000	0.844	165	203	21	22500-3473	53G1	8.125	10.125	0.875	206	257	22
22987-5234	53F1	7.500	9.250	0.938	191	235	24	22500-3544	53G1	7.500	8.500	0.625	191	216	16
22987-5260	53F1	8.000	9.500	0.969	203	241	25	22501-1101	53G1	7.875	9.055	0.688	200	230	17
22987-5319	53F1	3.438	4.500	0.875	87	114	22	22501-2070	53G1	6.625	8.000	0.750	168	203	19
22987-5332	53F1	3.375	4.750	0.750	86	121	19	22501-2464	53G1	3.750	4.750	0.625	95	121	16
22987-5884	53F1	6.125	7.500	0.969	156	191	25	22501-2470	53G1	3.750	4.999	0.625	95	127	16
22987-5892	53F1	4.500	5.500	0.719	114	140	18	22501-2539	53G1	4.000	5.000	0.625	102	127	16
22987-6051	53F1	6.625	8.000	0.844	168	203	21	22501-2590	53G1	3.000	4.125	0.625	76	105	16
22987-6159	53F1	3.438	4.875	0.719	87	124	18	22501-2875	53G1	4.875	6.000	0.625	124	152	16
22987-6433	53F1	7.000	8.000	0.844	178	203	21	22501-2923	53G1	5.000	6.250	0.625	127	159	16
22987-6437	53F1	7.000	8.500	0.969	178	216	25	22501-3073	53G1	5.250	6.750	0.625	133	171	16
22987-6447	53F1	10.625	12.500	0.969	270	318	25	22501-3230	53G1	5.625	6.625	0.625	143	168	16
22987-6520	53F1	8.625	10.500	1.000	219	267	25	22501-3369	53G1	6.000	7.500	0.625	152	191	16
22987-6590	53F1	3.625	4.625	0.719	92	117	18	22501-3392	53G1	11.000	12.000	0.750	279	305	19
22987-6603	53F1	5.000	6.000	0.719	127	152	18	22501-3498	53G1	7.000	8.375	0.625	178	213	16
22987-6661	53F1	8.000	9.250	0.840	203	235	21	22501-3545	53G1	7.500	8.500	0.750	191	216	19
22987-6726	53F1	9.125	11.125	1.250	232	283	32	22502-0939	53G1	4.000	5.375	0.625	102	137	16
22987-6741	53F1	5.500	6.500	0.719	140	165	18	22502-0941	53G1	3.188	5.000	0.625	81	127	16
22987-6760	53F1	8.500	10.000	1.000	216	254	25	22502-2162	53G1	6.693	7.874	0.716	170	200	18
22987-6846	53F1-L	14.875	16.875	1.219	378	429	31	22502-2164	53G1	7.402	8.465	0.755	188	215	19
22987-6902	53F1	4.938	6.500	0.719	125	165	18	22502-2323	53G1	3.375	4.375	0.625	86	111	16
22987-6917	53F1	4.438	5.750	0.719	113	146	18	22502-2419	53G1	3.625	4.625	0.625	92	117	16

All dimensions are in inches. Preferred sizes are indicated with **bold** type face.  
 Sizes listed are for standard nitrile elements, except Models 25 and 62 which have PTFE elements. Other material available on inquiry only.

## Oil Seals by Model Number

Product Code	Model	Inches			MM			Product Code	Model	Inches			MM		
		ID	OD	Width	ID	OD	Width			ID	OD	Width	ID	OD	Width
22502-2464	53G1	3.750	4.750	0.625	95	121	16	22543-7330	53R1	6.250	7.250	0.906	159	184	23
22502-2521	53G1	3.938	5.000	0.625	100	127	16	22544-6166	53R1	5.750	7.000	0.906	146	178	23
22502-2917	53G1	5.000	6.000	0.625	127	152	16	22544-6708	53R1	3.250	4.249	0.906	83	108	23
22502-3277	53G1	5.750	6.750	0.625	146	171	16	22544-9299	53R1	8.500	9.500	1.094	216	241	28
22537-1178	53R1	6.000	7.125	0.906	152	181	23	22627-3052	53R2	5.750	6.750	0.906	146	171	23
22537-2955	53R1	8.500	9.500	1.375	216	241	35	22627-3694	53R2	11.000	13.000	1.000	279	330	25
22537-3694	53R1	11.000	13.000	1.000	279	330	25	22627-4345	53R2	5.875	6.875	0.969	149	175	25
22537-4711	53R1	5.625	6.750	0.906	143	171	23	22627-4378	53R2-L	15.000	16.500	1.250	381	419	32
22537-4825	53R1	5.500	6.500	0.906	140	165	23	22627-4446	53R2	6.063	7.500	0.906	154	191	23
22537-4836	53R1	4.750	6.000	0.906	121	152	23	22627-4491	53R2-L	20.750	22.750	1.750	527	578	44
22537-4837	53R1	4.250	5.375	0.906	108	137	23	22627-4650	53R2-L	16.250	17.750	1.281	413	451	33
22537-4925	53R1	9.500	11.500	1.313	241	292	33	22627-4668	53R2	5.000	6.500	0.906	127	165	23
22537-5021	53R1	9.250	10.750	1.375	235	273	35	22627-4751	53R2	12.375	13.875	1.438	314	352	37
22537-5049	53R1	3.938	5.000	0.906	100	127	23	22627-4752	53R2	4.125	5.500	0.969	105	140	25
22537-5094	53R1	3.250	5.125	0.844	83	130	21	22627-4828	53R2	5.000	6.250	0.906	127	159	23
22537-5183	53R1	3.437	4.500	0.906	87	114	23	22627-4836	53R2	4.750	6.000	0.906	121	152	23
22537-5260	53R1	8.000	9.500	0.969	203	241	25	22627-4884	53R2	12.000	13.875	1.313	305	352	33
22537-5300	53R1	3.500	4.500	0.813	89	114	21	22627-4894	53R2-L	15.000	17.000	1.312	381	432	33
22537-5420	53R1	5.750	7.250	0.906	146	184	23	22627-4904	53R2	4.250	5.250	0.906	108	133	23
22537-5949	53R1	9.000	11.000	1.375	229	279	35	22627-4982	53R2	5.125	6.500	0.906	130	165	23
22537-5950	53R1	12.000	13.500	1.313	305	343	33	22627-5021	53R2	9.250	10.750	1.375	235	273	35
22537-6089	53R1	7.125	8.625	1.094	181	219	28	22627-5090	53R2	5.687	7.500	0.906	144	191	23
22537-6140	53R1	8.500	9.500	1.313	216	241	33	22627-5183	53R2	3.437	4.500	0.906	87	114	23
22537-6154	53R1-L	13.500	15.500	1.375	343	394	35	22627-5285	53R2	4.750	5.750	0.938	121	146	24
22537-6432	53R1	5.125	6.125	0.844	130	156	21	22627-5324	53R2	5.625	6.875	0.969	143	175	25
22537-6433	53R1	7.000	8.000	0.844	178	203	21	22627-5500	53R2	7.250	8.250	1.344	184	210	34
22537-6434	53R1	4.000	5.250	0.906	102	133	23	22627-5531	53R2	6.500	7.500	0.906	165	191	23
22537-6461	53R1	3.188	4.249	0.906	81	108	23	22627-5645	53R2	3.875	4.875	0.906	98	124	23
22537-6521	53R1	9.000	10.500	1.375	229	267	35	22627-5918	53R2	8.375	9.875	1.156	213	251	29
22537-6534	53R1	3.500	4.500	0.906	89	114	23	22627-5927	53R2	11.000	12.500	1.375	279	318	35
22537-6564	53R1	7.500	9.000	1.344	191	229	34	22627-5932	53R2	7.875	9.375	0.969	200	238	25
22537-6663	53R1	9.250	11.000	1.375	235	279	35	22627-6063	53R2	11.375	13.000	1.375	289	330	35
22537-6685	53R1	4.500	5.500	0.969	114	140	25	22627-6082	53R2	4.125	5.250	0.906	105	133	23
22537-6708	53R1	3.250	4.249	0.906	83	108	23	22627-6117	53R2-L	15.000	17.000	1.250	381	432	32
22537-6711	53R1	5.000	6.000	0.906	127	152	23	22627-6146	53R2	6.125	7.500	0.906	156	191	23
22537-6760	53R1	8.500	10.000	1.000	216	254	25	22627-6154	53R2-L	13.500	15.500	1.375	343	394	35
22537-6770	53R1	8.500	10.500	1.313	216	267	33	22627-6432	53R2	5.125	6.125	0.844	130	156	21
22537-7269	53R1	3.500	4.750	0.844	89	121	21	22627-6437	53R2	7.000	8.500	0.969	178	216	25
22537-7330	53R1	6.250	7.250	0.906	159	184	23	22627-6461	53R2	3.188	4.249	0.906	81	108	23
22537-7433	53R1	6.000	7.500	0.906	152	191	23	22627-6521	53R2	9.000	10.500	1.375	229	267	35
22537-7560	53R1	4.500	6.000	0.906	114	152	23	22627-6528	53R2	3.250	4.500	0.906	83	114	23
22537-7611	53R1	3.500	4.875	0.969	89	124	25	22627-6534	53R2	3.500	4.500	0.906	89	114	23
22537-7905	53R1	3.563	5.250	0.906	91	133	23	22627-6545	53R2	3.563	4.625	0.906	91	117	23
22537-8384	53R1	7.500	8.500	1.094	191	216	28	22627-6563	53R2	4.250	5.750	0.906	108	146	23
22537-8396	53R1	3.625	4.750	0.906	92	121	23	22627-6596	53R2	7.500	9.250	1.219	191	235	31
22537-8454	53R1	4.331	5.500	0.875	110	140	22	22627-6607	53R2-L	13.000	15.000	1.375	330	381	35
22537-8480	53R1	5.875	7.250	0.906	149	184	23	22627-6640	53R2	5.000	6.000	0.969	127	152	25
22537-8662	53R1	10.000	12.000	1.813	254	305	46	22627-6663	53R2	9.250	11.000	1.375	235	279	35
22537-8687	53R1	8.750	10.750	1.375	222	273	35	22627-6685	53R2	4.500	5.500	0.969	114	140	25
22537-8751	53R1	8.000	9.000	1.156	203	229	29	22627-6708	53R2	3.250	4.249	0.906	83	108	23
22537-8756	53R1	10.000	12.000	1.250	254	305	32	22627-6711	53R2	5.000	6.000	0.906	127	152	23
22537-9087	53R1	7.250	8.250	1.156	184	210	29	22627-6739	53R2	3.125	4.125	0.906	79	105	23
22537-9299	53R1	8.500	9.500	1.094	216	241	28	22627-6746	53R2	6.000	7.000	0.969	152	178	25
22537-9618	53R1	8.375	9.750	1.156	213	248	29	22627-6799	53R2	4.000	5.000	0.906	102	127	23
22537-9713	53R1	9.750	11.000	1.375	248	279	35	22627-6806	53R2	3.750	5.000	0.906	95	127	23
22543-5049	53R1	3.938	5.000	0.906	100	127	23	22627-6814	53R2	4.875	6.500	0.906	124	165	23

All dimensions are in inches. Preferred sizes are indicated with **bold** type face.

Sizes listed are for standard nitrile elements, except Models 25 and 62 which have PTFE elements. Other material available on inquiry only.

## Oil Seals by Model Number

Product Code	Model	Inches			MM			Product Code	Model	Inches			MM		
		ID	OD	Width	ID	OD	Width			ID	OD	Width	ID	OD	Width
22627-6842	53R2	10.000	12.000	1.375	254	305	35	22897-4668	53T2	5.000	6.500	0.906	127	165	23
22627-6901	53R2	3.625	4.625	0.906	92	117	23	22897-4708	53T2	4.875	6.625	0.969	124	168	25
22627-6942	53R2	9.500	10.750	1.375	241	273	35	22897-4752	53T2	4.125	5.500	0.969	105	140	25
22627-6954	53R2	7.750	8.750	1.156	197	222	29	22897-4894	53T2-L	15.000	17.000	1.313	381	432	33
22627-6968	53R2	3.125	5.000	0.906	79	127	23	22897-5043	53T2	4.688	5.750	0.906	119	146	23
22627-6969	53R2	8.500	9.500	0.969	216	241	25	22897-5304	53T2-L	13.750	15.750	1.438	349	400	37
22627-7245	53R2	4.625	5.750	0.906	117	146	23	22897-5531	53T2	6.500	7.500	0.906	165	191	23
22627-7247	53R2	6.250	7.750	0.906	159	197	23	22897-5584	53T2	11.500	13.000	1.250	292	330	32
22627-7315	53R2	4.938	6.500	0.906	125	165	23	22897-5758	53T2	3.000	4.500	0.937	76	114	24
22627-7324	53R2	3.500	5.000	0.906	89	127	23	22897-5883	53T2	8.000	9.250	1.000	203	235	25
22627-7326	53R2	12.000	13.625	1.438	305	346	37	22897-5923	53T2	5.500	7.000	0.969	140	178	25
22627-7358	53R2	7.750	9.250	0.875	197	235	22	22897-5941	53T2	3.188	4.249	0.969	81	108	25
22627-7360	53R2	7.000	8.500	0.875	178	216	22	22897-6463	53T2	4.875	6.625	0.906	124	168	23
22627-7404	53R2-L	18.000	19.500	1.250	457	495	32	22897-6505	53T2	3.625	5.500	0.969	92	140	25
22627-7409	53R2	5.500	6.750	0.906	140	171	23	22897-6511	53T2	3.000	4.500	0.906	76	114	23
22627-7419	53R2	3.250	4.250	0.969	83	108	25	22897-6527	53T2-L	12.500	14.500	1.313	318	368	33
22627-7433	53R2	6.000	7.500	0.906	152	191	23	22897-6534	53T2	3.500	4.500	0.906	89	114	23
22627-7440	53R2	3.750	4.750	0.906	95	121	23	22897-6545	53T2	3.562	4.625	0.906	90	117	23
22627-7559	53R2	4.000	5.125	0.906	102	130	23	22897-6640	53T2	5.000	6.000	0.969	127	152	25
22627-7560	53R2	4.500	6.000	0.906	114	152	23	22897-6746	53T2	6.000	7.000	0.969	152	178	25
22627-7562	53R2	9.250	11.250	1.375	235	286	35	22897-6750	53T2	5.250	6.500	0.969	133	165	25
22627-7610	53R2	5.250	6.750	0.906	133	171	23	22897-6793	53T2-L	18.000	20.000	1.813	457	508	46
22627-8202	53R2	4.375	5.375	0.906	111	137	23	22897-6806	53T2	3.750	4.999	0.906	95	127	23
22627-8384	53R2	7.500	8.500	1.094	191	216	28	22897-6893	53T2	5.000	6.250	0.969	127	159	25
22627-8396	53R2	3.625	4.750	0.906	92	121	23	22897-6969	53T2	8.500	9.500	0.969	216	241	25
22627-8441	53R2	3.250	5.000	0.906	83	127	23	22897-7110	53T2	4.500	5.500	0.906	114	140	23
22627-8630	53R2	4.875	6.000	0.906	124	152	23	22897-7128	53T2	5.750	7.000	0.969	146	178	25
22627-8635	53R2	4.313	5.500	0.969	110	140	25	22897-7181	53T2	3.125	4.875	0.969	79	124	25
22627-8685	53R2	6.875	8.125	1.406	175	206	36	22897-7258	53T2	4.500	5.750	0.969	114	146	25
22627-8687	53R2	8.750	10.750	1.375	222	273	35	22897-7347	53T2	5.125	6.125	0.906	130	156	23
22627-8700	53R2	3.250	4.500	0.844	83	114	21	22897-7357	53T2	3.375	4.375	0.906	86	111	23
22627-8775	53R2	6.625	8.125	0.969	168	206	25	22897-7365	53T2	5.125	6.125	0.969	130	156	25
22627-8909	53R2	9.500	11.250	1.375	241	286	35	22897-7370	53T2	8.000	9.750	1.406	203	248	36
22627-9036	53R2	11.500	13.500	1.250	292	343	32	22897-7392	53T2-L	12.000	14.000	1.250	305	356	32
22627-9165	53R2	8.000	9.000	0.969	203	229	25	22897-7419	53T2	3.250	4.250	0.969	83	108	25
22627-9414	53R2	8.500	10.500	1.250	216	267	32	22897-7551	53T2	3.000	4.500	0.969	76	114	25
22627-9419	53R2-L	12.500	14.500	1.250	318	368	32	22897-7562	53T2	9.250	11.250	1.375	235	286	35
22627-9422	53R2	5.750	7.250	1.031	146	184	26	22897-7609	53T2	6.375	7.500	0.969	162	191	25
22627-9423	53R2-L	18.000	20.000	1.750	457	508	44	22897-7611	53T2	3.500	4.875	0.969	89	124	25
22627-9854	53R2	5.750	7.000	0.844	146	178	21	22897-7689	53T2	4.625	6.000	0.969	117	152	25
22627-9970	53R2	8.000	10.000	1.375	203	254	35	22897-7774	53T2	10.500	12.500	1.375	267	318	35
22627-9972	53R2	5.250	7.125	0.906	133	181	23	22897-7786	53T2	8.125	10.125	1.281	206	257	33
22634-6712	53R2	6.438	7.500	0.906	164	191	23	22897-7803	53T2	4.375	5.500	0.969	111	140	25
22634-7283	53R2-L	12.000	14.000	1.375	305	356	35	22897-7823	53T2	9.125	10.625	1.250	232	270	32
22634-7324	53R2	3.500	5.000	0.906	89	127	23	22897-7864	53T2	6.250	7.250	0.969	159	184	25
22634-7433	53R2	6.000	7.500	0.906	152	191	23	22897-8608	53T2	3.188	5.000	0.969	81	127	25
23708-5183	53R2	3.437	4.500	0.906	87	114	23	22897-8630	53T2	4.875	6.000	0.906	124	152	23
23708-6596	53R2	7.500	9.250	1.219	191	235	31	22897-8685	53T2	6.875	8.125	1.406	175	206	36
23708-6806	53R2	3.750	5.000	0.906	95	127	23	22897-8811	53T2	4.188	5.250	0.969	106	133	25
23708-7348	53R2	4.688	6.000	0.906	119	152	23	22903-4868	53T2	6.000	7.250	0.969	152	184	25
23708-7419	53R2	3.250	4.250	0.969	83	108	25	22903-7689	53T2	4.625	6.000	0.969	117	152	25
23708-8202	53R2	4.375	5.375	0.906	111	137	23	24750-0800	59G1	10.000	12.000	1.000	254	305	25
22897-3040	53T2	10.000	11.500	1.062	254	292	27	24750-5418	59G1	7.500	9.000	0.937	191	229	24
22897-4378	53T2-L	15.000	16.500	1.250	381	419	32	24750-5429	59G1	10.236	11.811	0.787	260	300	20
22897-4545	53T2	8.250	9.500	1.125	210	241	29	24750-5626	59G1	7.402	8.465	0.630	188	215	16
22897-4650	53T2-L	16.250	17.750	1.281	413	451	33	24750-5921	59G1	24.409	26.378	0.984	620	670	25

All dimensions are in inches. Preferred sizes are indicated with **bold** type face. Sizes listed are for standard nitrile elements, except Models 25 and 62 which have PTFE elements. Other material available on inquiry only.

## Oil Seals by Model Number

Product Code	Model	Inches			MM			Product Code	Model	Inches			MM		
		ID	OD	Width	ID	OD	Width			ID	OD	Width	ID	OD	Width
24751-0062	59G1	9.750	11.250	0.625	248	286	16	23078-7145	63F1	2.062	3.000	0.594	52	76	15
24751-0345	59G1	19.000	20.500	0.750	483	521	19	23078-7152	63F1	1.625	2.438	0.594	41	62	15
24751-0369	59G1	20.250	22.500	0.875	514	572	22	23078-7254	63F1	1.688	2.500	0.594	43	64	15
24751-0551	59G1	36.000	38.000	0.875	914	965	22	23078-7328	63F1	3.000	4.003	0.594	76	102	15
24751-1914	59G1	8.875	10.125	0.750	225	257	19	23078-7372	63F1	1.250	2.375	0.594	32	60	15
24751-3067	59G1	5.250	6.500	0.625	133	165	16	23078-7542	63F1	3.000	3.750	0.594	76	95	15
24751-3501	59G1	7.000	8.500	0.750	178	216	19	23078-7555	63F1	1.750	3.000	0.594	44	76	15
24751-3654	59G1	9.750	11.250	0.750	248	286	19	23078-7568	63F1	1.500	2.250	0.594	38	57	15
24751-3670	59G1	10.000	11.250	0.750	254	286	19	23078-7662	63F1	0.625	1.250	0.438	16	32	11
24751-3925	59G1	8.000	10.000	0.750	203	254	19	23078-7829	63F1	2.750	3.500	0.594	70	89	15
24751-4013	59G1	10.500	12.125	0.750	267	308	19	23078-8318	63F1	0.594	1.125	0.438	15	29	11
24751-4016	59G1	10.500	12.500	0.750	267	318	19	23078-8498	63F1	2.250	2.997	0.750	57	76	19
24751-4517	59G1	25.591	27.953	0.984	650	710	25	23078-8679	63F1	2.687	3.751	0.594	68	95	15
24751-5075	59G1	26.125	27.625	0.750	664	702	19	23078-9070	63F1	2.812	4.003	0.594	71	102	15
24751-5300	59G1	31.000	32.500	0.750	787	826	19	23078-9093	63F1	2.500	3.372	0.594	64	86	15
24751-5823	59G1	30.250	32.250	0.875	768	819	22	23078-9234	63F1	1.688	2.438	0.625	43	62	16
24751-5993	59G1	26.000	27.625	1.000	660	702	25	23078-9833	63F1	1.375	2.125	0.625	35	54	16
24751-5994	59G1	16.750	18.000	0.750	425	457	19	23500-2052	63G1	2.750	4.003	0.500	70	102	13
24751-5995	59G1	14.750	16.500	0.812	375	419	21	23501-0719	63G1	2.625	3.484	0.500	67	88	13
24751-6033	59G1	7.000	8.750	0.813	178	222	21	23501-0857	63G1	1.375	2.000	0.500	35	51	13
24751-6301	59G1	13.250	14.750	0.750	337	375	19	23501-0915	63G1	1.750	2.750	0.500	44	70	13
24752-0234	59G1	14.500	16.500	0.750	368	419	19	23501-0924	63G1	1.750	2.875	0.500	44	73	13
24752-0261	59G1	15.500	17.500	0.750	394	445	19	23501-0943	63G1	1.375	2.835	0.500	35	72	13
24752-3656	59G1	37.797	40.945	1.031	960	1040	26	23501-1206	63G1	2.000	3.000	0.500	51	76	13
24752-4869	59G1	11.750	13.250	0.750	298	337	19	23501-1323	63G1	2.125	2.875	0.500	54	73	13
24752-5144	59G1	10.433	11.417	0.755	265	290	19	23501-1506	63G1	2.250	3.500	0.500	57	89	13
24752-5626	59G1	7.402	8.465	0.630	188	215	16	23501-1737	63G1	2.438	3.250	0.500	62	83	13
24754-4067	59G1	12.000	13.500	0.750	305	343	19	23501-1809	63G1	2.500	3.250	0.500	64	83	13
23070-7328	63F1	3.000	4.003	0.594	76	102	15	23501-2117	63G1	2.875	3.623	0.500	73	92	13
23078-0018	63F1	0.375	1.000	0.375	10	25	10	23501-2713	63G1	1.375	2.500	0.500	35	64	13
23078-2967	63F1	1.875	3.000	0.594	48	76	15	23501-3121	63G1	0.984	2.047	0.433	25	52	11
23078-4735	63F1	2.250	3.500	0.594	57	89	15	23501-3665	63G1	1.375	2.441	0.500	35	62	13
23078-4746	63F1	2.375	3.246	0.594	60	82	15	23501-6627	63G1	2.863	4.724	0.500	73	120	13
23078-5041	63F1	0.688	1.250	0.438	17	32	11	23501-9180	63G1	1.125	2.000	0.500	29	51	13
23078-5208	63F1	2.250	2.997	0.594	57	76	15	23502-0086	63G1	0.625	1.375	0.437	16	35	11
23078-5283	63F1	2.000	2.750	0.625	51	70	16	23502-0657	63G1	1.500	2.500	0.500	38	64	13
23078-5387	63F1	2.500	3.500	0.750	64	89	19	23502-0938	63G1	2.938	4.000	0.625	75	102	16
23078-5391	63F1	0.500	1.125	0.531	13	29	13	23502-1322	63G1	2.125	2.875	0.438	54	73	11
23078-5657	63F1	0.625	1.125	0.500	16	29	13	23502-1323	63G1	2.125	2.875	0.500	54	73	13
23078-5687	63F1	2.125	3.062	0.750	54	78	19	23502-1941	63G1	2.625	3.500	0.500	67	89	13
23078-6028	63F1	1.750	2.625	0.594	44	67	15	23502-2165	63G1	1.654	2.441	0.598	42	62	15
23078-6244	63F1	2.688	3.500	0.594	68	89	15	23502-2170	63G1	3.000	3.751	0.500	76	95	13
23078-6270	63F1	2.438	3.372	0.594	62	86	15	23503-0936	63G1	2.750	3.500	0.625	70	89	16
23078-6459	63F1	2.375	3.125	0.594	60	79	15	23052-4592	63R1	2.125	2.875	0.688	54	73	17
23078-6470	63F1	1.000	1.750	0.500	25	44	13	23052-7187	63R1	2.625	3.500	0.688	67	89	17
23078-6506	63F1	2.500	3.250	0.594	64	83	15	23547-4592	63R1	2.125	2.875	0.688	54	73	17
23078-6523	63F1	0.875	1.375	0.438	22	35	11	23547-4700	63R1	0.875	1.500	0.563	22	38	14
23078-6524	63F1	1.000	1.625	0.438	25	41	11	23547-4754	63R1	0.750	1.375	0.563	19	35	14
23078-6612	63F1	0.750	1.250	0.438	19	32	11	23547-4766	63R1	1.625	2.625	0.688	41	67	17
23078-6700	63F1	2.563	3.500	0.594	65	89	15	23547-4819	63R1	0.937	1.500	0.562	24	38	14
23078-6755	63F1	1.000	1.500	0.438	25	38	11	23547-4905	63R1	2.250	3.147	0.687	57	80	17
23078-6904	63F1	2.000	3.000	0.594	51	76	15	23547-4914	63R1	2.375	3.500	0.687	60	89	17
23078-6927	63F1	0.750	1.375	0.438	19	35	11	23547-5483	63R1	2.625	3.625	0.688	67	92	17
23078-6986	63F1	0.500	1.125	0.563	13	29	14	23547-5568	63R1	2.000	2.997	0.687	51	76	17
23078-6993	63F1	1.188	2.000	0.594	30	51	15	23547-5893	63R1	0.438	0.875	0.594	11	22	15
23078-7142	63F1	2.250	3.147	0.594	57	80	15	23547-6438	63R1	2.000	3.000	0.687	51	76	17

All dimensions are in inches. Preferred sizes are indicated with **bold** type face.

Sizes listed are for standard nitrile elements, except Models 25 and 62 which have PTFE elements. Other material available on inquiry only.

## Oil Seals by Model Number

Product Code	Model	Inches			MM			Product Code	Model	Inches			MM		
		ID	OD	Width	ID	OD	Width			ID	OD	Width	ID	OD	Width
23547-6465	63R1	2.500	3.500	0.688	64	89	17	23548-6478	63R2	2.250	3.000	0.688	57	76	17
23547-6467	63R1	2.750	3.751	0.687	70	95	17	23548-6487	63R2	2.437	3.125	0.687	62	79	17
23547-6469	63R1	1.937	3.000	0.687	49	76	17	23548-6517	63R2	1.250	2.375	0.688	32	60	17
23547-6476	63R1	0.875	1.625	0.562	22	41	14	23548-6522	63R2	1.750	3.000	0.687	44	76	17
23547-6477	63R1	1.000	1.625	0.563	25	41	14	23548-6536	63R2	2.000	3.375	0.688	51	86	17
23547-6479	63R1	1.375	2.125	0.687	35	54	17	23548-6543	63R2	3.000	3.751	0.688	76	95	17
23547-6522	63R1	1.750	3.000	0.688	44	76	17	23548-6546	63R2	1.875	2.625	0.688	48	67	17
23547-6576	63R1	1.375	2.062	0.688	35	52	17	23548-6551	63R2	1.500	2.500	0.687	38	64	17
23547-6588	63R1	2.938	4.003	0.688	75	102	17	23548-6554	63R2	1.688	2.750	0.688	43	70	17
23547-6667	63R1	1.500	2.375	0.688	38	60	17	23548-6566	63R2	2.500	3.751	0.688	64	95	17
23547-6674	63R1	1.250	2.125	0.687	32	54	17	23548-6567	63R2	0.563	1.125	0.563	14	29	14
23547-6675	63R1	1.250	2.250	0.687	32	57	17	23548-6580	63R2	1.000	1.828	0.688	25	46	17
23547-6730	63R1	2.875	3.751	0.688	73	95	17	23548-6593	63R2	2.125	3.000	0.688	54	76	17
23547-6745	63R1	1.250	2.000	0.688	32	51	17	23548-6599	63R2	2.875	4.003	0.688	73	102	17
23547-6757	63R1	2.250	3.500	0.688	57	89	17	23548-6608	63R2	2.000	2.686	0.688	51	68	17
23547-6774	63R1	1.375	2.250	0.688	35	57	17	23548-6637	63R2	0.625	1.125	0.563	16	29	14
23547-6832	63R1	1.750	2.750	0.688	44	70	17	23548-6651	63R2	2.625	3.751	0.688	67	95	17
23547-6857	63R1	1.125	1.750	0.688	29	44	17	23548-6667	63R2	1.500	2.375	0.688	38	60	17
23547-6860	63R1	1.625	2.500	0.688	41	64	17	23548-6675	63R2	1.250	2.250	0.687	32	57	17
23547-6937	63R1	1.500	2.250	0.688	38	57	17	23548-6694	63R2	1.000	1.500	0.563	25	38	14
23547-7146	63R1	0.250	0.750	0.469	6	19	12	23548-6716	63R2	2.750	3.500	0.688	70	89	17
23547-7150	63R1	0.625	1.250	0.562	16	32	14	23548-6720	63R2	0.750	1.250	0.563	19	32	14
23547-7187	63R1	2.625	3.500	0.688	67	89	17	23548-6730	63R2	2.875	3.751	0.688	73	95	17
23547-7197	63R1	3.000	4.003	0.688	76	102	17	23548-6745	63R2	1.250	2.000	0.688	32	51	17
23547-7210	63R1	2.688	3.751	0.688	68	95	17	23548-6753	63R2	1.688	2.686	0.688	43	68	17
23547-7215	63R1	1.000	1.750	0.688	25	44	17	23548-6795	63R2	2.250	2.997	0.688	57	76	17
23547-7280	63R1	1.563	2.438	0.688	40	62	17	23548-6800	63R2	2.625	4.003	0.688	67	102	17
23547-7563	63R1	2.000	2.750	0.688	51	70	17	23548-6832	63R2	1.750	2.750	0.688	44	70	17
23547-7569	63R1	1.688	2.375	0.688	43	60	17	23548-6856	63R2	0.625	1.375	0.563	16	35	14
23547-7691	63R1	2.250	3.246	0.688	57	82	17	23548-6899	63R2	1.562	2.500	0.687	40	64	17
23547-8104	63R1	1.563	2.375	0.688	40	60	17	23548-6966	63R2	2.500	4.003	0.688	64	102	17
23547-8470	63R1	2.938	3.875	0.688	75	98	17	23548-7100	63R2	0.969	2.062	0.688	25	52	17
23547-8704	63R1	1.500	2.250	0.531	38	57	13	23548-7136	63R2	2.437	3.189	0.687	62	81	17
23547-9417	63R1	1.000	1.750	0.625	25	44	16	23548-7159	63R2	2.813	3.751	0.688	71	95	17
23561-5893	63R1	0.437	0.875	0.594	11	22	15	23548-7160	63R2	2.125	3.125	0.688	54	79	17
23561-6477	63R1	1.000	1.625	0.563	25	41	14	23548-7187	63R2	2.625	3.500	0.688	67	89	17
23712-5893	63R1	0.437	0.875	0.594	11	22	15	23548-7197	63R2	3.000	4.003	0.688	76	102	17
23548-1171	63R2	2.875	3.876	0.688	73	98	17	23548-7215	63R2	1.000	1.750	0.687	25	44	17
23548-3416	63R2	1.031	1.575	0.562	26	40	14	23548-7223	63R2	1.938	2.625	0.688	49	67	17
23548-4665	63R2	2.250	3.250	0.688	57	83	17	23548-7228	63R2	1.750	2.625	0.687	44	67	17
23548-4670	63R2	2.000	2.875	0.688	51	73	17	23548-7563	63R2	2.000	2.750	0.688	51	70	17
23548-4671	63R2	1.750	2.437	0.688	44	62	17	23548-7564	63R2	2.500	3.250	0.688	64	83	17
23548-4734	63R2	2.500	3.876	0.687	64	98	17	23548-8104	63R2	1.563	2.375	0.688	40	60	17
23548-4844	63R2	2.500	3.543	0.687	64	90	17	23548-8187	63R2	1.188	1.875	0.688	30	48	17
23548-4887	63R2	1.000	1.875	0.688	25	48	17	23548-8293	63R2	1.875	2.875	0.688	48	73	17
23548-4958	63R2	2.313	3.250	0.688	59	83	17	23548-8339	63R2	0.625	1.500	0.562	16	38	14
23548-5053	63R2	2.000	3.125	0.687	51	79	17	23548-8404	63R2	2.125	3.350	0.687	54	85	17
23548-5483	63R2	2.625	3.625	0.688	67	92	17	23548-8496	63R2	0.375	0.875	0.469	10	22	12
23548-5653	63R2	0.938	1.875	0.625	24	48	16	23548-8643	63R2	1.875	2.750	0.687	48	70	17
23548-5968	63R2	2.375	3.062	0.688	60	78	17	23548-8646	63R2	1.719	2.625	0.687	44	67	17
23548-5980	63R2	2.373	3.350	0.688	60	85	17	23548-8863	63R2	2.938	3.623	0.688	75	92	17
23548-6438	63R2	2.000	3.000	0.688	51	76	17	23548-8930	63R2	2.500	3.625	0.688	64	92	17
23548-6452	63R2	1.125	1.625	0.562	29	41	14	23548-9040	63R2	2.687	3.623	0.687	68	92	17
23548-6465	63R2	2.500	3.500	0.688	64	89	17	23548-9621	63R2	2.062	2.997	0.688	52	76	17
23548-6467	63R2	2.750	3.751	0.688	70	95	17	23624-6478	63R2	2.250	3.000	0.688	57	76	17
23548-6468	63R2	2.375	3.751	0.688	60	95	17	23627-4671	63R2	1.750	2.437	0.688	44	62	17

All dimensions are in inches. Preferred sizes are indicated with **bold** type face. Sizes listed are for standard nitrile elements, except Models 25 and 62 which have PTFE elements. Other material available on inquiry only.

## Oil Seals by Model Number

Product Code	Model	Inches			MM			Product Code	Model	Inches			MM		
		ID	OD	Width	ID	OD	Width			ID	OD	Width	ID	OD	Width
23627-6452	63R2	1.125	1.625	0.563	29	41	14	23550-6745	63T2	1.250	2.000	0.688	32	51	17
23627-6467	63R2	2.750	3.751	0.688	70	95	17	23550-6753	63T2	1.688	2.686	0.688	43	68	17
23627-6478	63R2	2.250	3.000	0.688	57	76	17	23550-6757	63T2	2.250	3.500	0.688	57	89	17
23627-6551	63R2	1.500	2.500	0.687	38	64	17	23550-6856	63T2	0.625	1.375	0.563	16	35	14
23627-6567	63R2	0.563	1.125	0.563	14	29	14	23550-6857	63T2	1.125	1.750	0.688	29	44	17
23627-6593	63R2	2.125	3.000	0.688	54	76	17	23550-6860	63T2	1.625	2.500	0.688	41	64	17
23627-6745	63R2	1.250	2.000	0.688	32	51	17	23550-6904	63T2	2.000	3.000	0.594	51	76	15
23627-7197	63R2	3.000	4.003	0.688	76	102	17	23550-6934	63T2	1.688	2.625	0.688	43	67	17
23627-7228	63R2	1.750	2.625	0.688	44	67	17	23550-6937	63T2	1.500	2.250	0.688	38	57	17
23627-8104	63R2	1.563	2.375	0.688	40	60	17	23550-7146	63T2	0.250	0.750	0.469	6	19	12
23628-6477	63R2	1.000	1.625	0.563	25	41	14	23550-7150	63T2	0.625	1.250	0.563	16	32	14
23769-5968	63R2	2.375	3.062	0.688	60	78	17	23550-7167	63T2	2.437	3.751	0.687	62	95	17
23769-6855	63R2	1.375	2.000	0.687	35	51	17	23550-7184	63T2	0.750	1.500	0.563	19	38	14
23769-7187	63R2	2.625	3.500	0.688	67	89	17	23550-7197	63T2	3.000	4.003	0.688	76	102	17
23550-1452	63T2	1.250	1.875	0.688	32	48	17	23550-7223	63T2	1.938	2.625	0.688	49	67	17
23550-2494	63T2	2.406	3.125	0.687	61	79	17	23550-7261	63T2	1.563	2.783	0.688	40	71	17
23550-2577	63T2	0.750	1.750	0.688	19	44	17	23550-7405	63T2	0.669	1.575	0.563	17	40	14
23550-4592	63T2	2.125	2.875	0.688	54	73	17	23550-7563	63T2	2.000	2.750	0.688	51	70	17
23550-4648	63T2	2.969	3.751	0.688	75	95	17	23550-7569	63T2	1.688	2.375	0.688	43	60	17
23550-4659	63T2	2.187	2.875	0.687	56	73	17	23550-7595	63T2	1.250	1.984	0.688	32	50	17
23550-4665	63T2	2.250	3.250	0.687	57	83	17	23550-7722	63T2	2.937	4.125	0.719	75	105	18
23550-4670	63T2	2.000	2.875	0.688	51	73	17	23550-8187	63T2	1.188	1.875	0.688	30	48	17
23550-4671	63T2	1.750	2.437	0.688	44	62	17	23550-8266	63T2	1.625	2.875	0.688	41	73	17
23550-4672	63T2	1.750	2.500	0.688	44	64	17	23550-8267	63T2	0.563	1.375	0.563	14	35	14
23550-4754	63T2	0.750	1.375	0.563	19	35	14	23550-8562	63T2	0.781	1.250	0.563	20	32	14
23550-4819	63T2	0.938	1.500	0.563	24	38	14	23550-9122	63T2	1.437	2.125	0.687	36	54	17
23550-4958	63T2	2.313	3.250	0.688	59	83	17	23552-1920	63T2	2.938	3.751	0.688	75	95	17
23550-4976	63T2	1.375	2.625	0.688	35	67	17	23552-6694	63T2	1.000	1.500	0.563	25	38	14
23550-5007	63T2	1.375	2.106	0.687	35	53	17	23626-6465	63T2	2.500	3.500	0.688	64	89	17
23550-5053	63T2	2.000	3.125	0.688	51	79	17	23626-6566	63T2	2.500	3.751	0.687	64	95	17
23550-5778	63T2	2.000	2.882	0.687	51	73	17	23626-7563	63T2	2.000	2.750	0.688	51	70	17
23550-6448	63T2	1.500	2.625	0.687	38	67	17	23549-6551	63TB	1.500	2.500	0.688	38	64	17
23550-6452	63T2	1.125	1.625	0.562	29	41	14	23549-6674	63TB	1.250	2.125	0.688	32	54	17
23550-6465	63T2	2.500	3.500	0.688	64	89	17	23549-6699	63TB	2.188	3.147	0.688	56	80	17
23550-6466	63T2	1.125	2.000	0.688	29	51	17	23549-7197	63TB	3.000	4.003	0.688	76	102	17
23550-6469	63T2	1.938	3.000	0.688	49	76	17	23549-8292	63TB	1.875	3.189	0.688	48	81	17
23550-6475	63T2	1.375	2.500	0.688	35	64	17	23549-9844	63TB	2.250	3.372	0.688	57	86	17
23550-6477	63T2	1.000	1.625	0.563	25	41	14	22503-2698	64G1-L	25.000	26.500	0.875	635	673	22
23550-6478	63T2	2.250	3.000	0.688	57	76	17	22503-3051	64G1-L	39.000	41.000	1.000	991	1041	25
23550-6500	63T2	0.875	1.375	0.563	22	35	14	22503-3761	64G1	11.750	13.250	0.812	298	337	21
23550-6522	63T2	1.750	3.000	0.687	44	76	17	22503-3823	64G1-L	26.125	28.125	1.000	664	714	25
23550-6546	63T2	1.875	2.625	0.688	48	67	17	22503-3898	64G1-L	36.500	38.500	1.000	927	978	25
23550-6551	63T2	1.500	2.500	0.688	38	64	17	22503-4469	64G1-L	40.500	42.500	1.000	1029	1080	25
23550-6554	63T2	1.688	2.750	0.688	43	70	17	22504-2132	64G1-L	14.500	16.000	0.813	368	406	21
23550-6566	63T2	2.500	3.751	0.688	64	95	17	22504-3119	64G1	11.000	13.000	0.938	279	330	24
23550-6576	63T2	1.375	2.062	0.688	35	52	17	22504-3350	64G1-L	30.250	32.500	1.000	768	826	25
23550-6593	63T2	2.125	3.000	0.688	54	76	17	22504-3352	64G1-L	26.125	27.625	0.875	664	702	22
23550-6599	63T2	2.875	4.003	0.688	73	102	17	22504-3353	64G1-L	31.000	32.500	0.875	787	826	22
23550-6624	63T2	1.250	2.062	0.688	32	52	17	22504-4368	64G1-L	31.000	33.000	1.000	787	838	25
23550-6637	63T2	0.625	1.125	0.563	16	29	14	22505-0818	64G1-L	13.000	14.500	0.813	330	368	21
23550-6662	63T2	0.781	1.500	0.562	20	38	14	22505-2412	64G1-L	15.000	16.500	0.812	381	419	21
23550-6667	63T2	1.500	2.375	0.688	38	60	17	22505-3781	64G1-L	27.000	29.000	1.000	686	737	25
23550-6688	63T2	1.125	1.875	0.687	29	48	17	21840-8628	64WS	41.875	43.500	1.000	1064	1105	25
23550-6694	63T2	1.000	1.500	0.563	25	38	14	21840-8903	64WS	45.000	46.625	1.000	1143	1184	25
23550-6720	63T2	0.750	1.250	0.563	19	32	14	21899-4438	64WS	37.500	39.500	0.875	953	1003	22
23550-6730	63T2	2.875	3.751	0.688	73	95	17	23683-4395	67R2	3.250	4.003	0.688	83	102	17

All dimensions are in inches. Preferred sizes are indicated with **bold** type face.

Sizes listed are for standard nitrile elements, except Models 25 and 62 which have PTFE elements. Other material available on inquiry only.

## Oil Seals by Model Number

Product Code	Model	Inches			MM			Product Code	Model	Inches			MM		
		ID	OD	Width	ID	OD	Width			ID	OD	Width	ID	OD	Width
23683-6566	67R2	2.500	3.751	0.688	64	95	17	24801-0815	EQUAL	1.125	2.250	0.625	29	57	16
23683-6593	67R2	2.125	3.000	0.688	54	76	17	24801-0832	EQUAL	1.125	2.125	0.625	29	54	16
23683-6720	67R2	0.750	1.250	0.563	19	32	14	24801-0850	EQUAL	0.875	2.000	0.500	22	51	13
26180-3522	87NS	7.250	8.500	0.625	184	216	16	24801-0857	EQUAL	1.000	2.125	0.500	25	54	13
26180-3566	87NS	7.625	9.125	0.625	194	232	16	24801-0879	EQUAL	1.750	2.875	0.500	44	73	13
26180-3623	87NS	9.000	11.000	0.750	229	279	19	24801-0901	EQUAL	2.750	3.875	0.500	70	98	13
26180-3818	87NS	8.250	9.500	0.750	210	241	19	24801-0909	EQUAL	1.750	2.625	0.500	44	67	13
26180-4950	87NS	10.000	11.500	0.625	254	292	16	24801-0930	EQUAL	4.000	5.248	0.500	102	133	13
26180-6618	87NS-L	15.250	17.250	0.625	387	438	16	24801-0932	EQUAL	4.125	5.500	0.500	105	140	13
26186-3522	88NS	7.250	8.500	0.625	184	216	16	24801-0988	EQUAL	1.125	2.000	0.625	29	51	16
26186-3623	88NS	9.000	11.000	0.750	229	279	19	24801-0989	EQUAL	1.875	2.625	0.625	48	67	16
26186-3818	88NS	8.250	9.500	0.750	210	241	19	24801-0998	EQUAL	1.750	2.875	0.625	44	73	16
26187-1083	88NS-L	22.750	25.500	0.875	578	648	22	24801-1008	EQUAL	1.375	2.250	0.500	35	57	13
26187-3891	88NS-L	14.250	16.250	0.625	362	413	16	24801-1017	EQUAL	1.375	2.836	0.500	35	72	13
26188-1382	88NS-L	22.047	23.780	0.709	560	604	18	24801-1019	EQUAL	1.334	2.363	0.500	34	60	13
26188-1383	88NS-L	19.685	21.654	0.787	500	550	20	24801-1026	EQUAL	1.750	2.500	0.625	44	64	16
26188-1387	88NS-L	17.126	19.094	0.787	435	485	20	24801-1028	EQUAL	3.250	4.000	0.625	83	102	16
26188-3522	88NS	7.250	8.500	0.625	184	216	16	24801-1041	EQUAL	2.750	3.543	0.500	70	90	13
26188-4163	88NS-L	15.500	17.500	0.813	394	445	21	24801-1048	EQUAL	1.250	2.125	0.500	32	54	13
26188-4170	88NS-L	15.750	17.250	0.688	400	438	17	24801-1051	EQUAL	5.000	5.750	0.500	127	146	13
26188-4188	88NS-L	17.000	18.500	0.688	432	470	17	24801-1056	EQUAL	4.000	5.250	0.438	102	133	11
26188-4216	88NS-L	18.500	20.500	0.875	470	521	22	24801-1059	EQUAL	1.875	2.875	0.500	48	73	13
26188-4239	88NS-L	20.250	21.750	0.750	514	552	19	24801-1062	EQUAL	1.750	2.625	0.625	44	67	16
26188-4265	88NS-L	21.750	23.750	0.875	552	603	22	24801-1072	EQUAL	1.875	2.813	0.500	48	71	13
26188-4270	88NS-L	22.000	24.000	0.875	559	610	22	24801-1075	EQUAL	1.875	2.750	0.625	48	70	16
26188-4308	88NS-L	25.000	26.500	0.750	635	673	19	24801-1078	EQUAL	2.953	3.938	0.500	75	100	13
26188-4318	88NS-L	25.500	27.500	0.875	648	699	22	24801-1081	EQUAL	2.875	3.750	0.625	73	95	16
26188-4382	88NS-L	33.000	35.000	0.875	838	889	22	24801-1082	EQUAL	4.331	5.511	0.625	110	140	16
26188-5619	88NS-L	21.000	23.000	0.750	533	584	19	24801-1083	EQUAL	1.000	2.000	0.625	25	51	16
26188-5921	88NS-L	26.000	27.625	0.750	660	702	19	24801-1084	EQUAL	1.181	2.875	0.500	30	73	13
26188-6383	88NS	8.500	9.500	0.500	216	241	13	24801-1090	EQUAL	0.875	1.750	0.625	22	44	16
26188-6618	88NS-L	15.250	17.250	0.625	387	438	16	24801-1092	EQUAL	1.375	2.125	0.625	35	54	16
26188-6787	88NS-L	33.000	34.625	0.750	838	879	19	24801-1099	EQUAL	1.500	2.378	0.500	38	60	13
26788-4265	88NS-L	21.750	23.750	0.875	552	603	22	24801-1116	EQUAL	1.438	2.250	0.625	37	57	16
24801-0625	EQUAL	0.875	1.875	0.500	22	48	13	24801-1121	EQUAL	1.375	2.250	0.625	35	57	16
24801-0627	EQUAL	1.000	2.000	0.500	25	51	13	24801-1122	EQUAL	1.181	2.362	0.500	30	60	13
24801-0639	EQUAL	1.750	2.750	0.500	44	70	13	24801-1127	EQUAL	1.968	2.952	0.500	50	75	13
24801-0648	EQUAL	1.500	2.375	0.500	38	60	13	24801-1129	EQUAL	2.563	3.437	0.500	65	87	13
24801-0702	EQUAL	8.000	9.000	0.500	203	229	13	24801-1136	EQUAL	2.313	3.355	0.625	59	85	16
24801-0706	EQUAL	1.875	3.000	0.625	48	76	16	24801-1138	EQUAL	1.375	2.835	0.625	35	72	16
24801-0716	EQUAL	2.375	3.126	0.500	60	79	13	24801-1144	EQUAL	3.938	4.938	0.625	100	125	16
24801-0717	EQUAL	1.625	2.500	0.500	41	64	13	24801-1147	EQUAL	2.750	3.755	0.500	70	95	13
24801-0720	EQUAL	1.750	3.000	0.500	44	76	13	24801-1156	EQUAL	2.500	3.550	0.625	64	90	16
24801-0738	EQUAL	2.375	3.250	0.500	60	83	13	24801-1166	EQUAL	1.500	2.625	0.625	38	67	16
24801-0741	EQUAL	1.438	2.250	0.500	37	57	13	24801-1177	EQUAL	5.625	6.625	0.625	143	168	16
24801-0748	EQUAL	1.875	2.625	0.500	48	67	13	24801-1205	EQUAL	2.875	4.003	0.625	73	102	16
24801-0754	EQUAL	1.375	2.500	0.625	35	64	16	24801-1206	EQUAL	2.000	3.000	0.500	51	76	13
24801-0756	EQUAL	0.875	1.750	0.500	22	44	13	24801-1211	EQUAL	2.375	3.500	0.625	60	89	16
24801-0765	EQUAL	1.125	2.001	0.500	29	51	13	24801-1212	EQUAL	2.500	3.375	0.625	64	86	16
24801-0770	EQUAL	1.625	2.750	0.625	41	70	16	24801-1214	EQUAL	1.500	2.375	0.625	38	60	16
24801-0787	EQUAL	1.250	2.375	0.625	32	60	16	24801-1215	EQUAL	1.250	2.000	0.625	32	51	16
24801-0790	EQUAL	1.688	2.500	0.500	43	64	13	24801-1220	EQUAL	3.000	4.000	0.625	76	102	16
24801-0792	EQUAL	1.875	2.875	0.625	48	73	16	24801-1225	EQUAL	2.063	3.000	0.625	52	76	16
24801-0798	EQUAL	1.250	2.000	0.500	32	51	13	24801-1245	EQUAL	2.250	3.375	0.625	57	86	16
24801-0804	EQUAL	1.500	2.250	0.500	38	57	13	24801-1249	EQUAL	2.000	2.750	0.625	51	70	16
24801-0811	EQUAL	4.250	5.500	0.625	108	140	16	24801-1251	EQUAL	2.563	3.563	0.625	65	91	16

All dimensions are in inches. Preferred sizes are indicated with **bold** type face.  
 Sizes listed are for standard nitrile elements, except Models 25 and 62 which have PTFE elements. Other material available on inquiry only.



## Oil Seals by Model Number

Product Code	Model	Inches			MM			Product Code	Model	Inches			MM		
		ID	OD	Width	ID	OD	Width			ID	OD	Width	ID	OD	Width
24801-1252	EQUAL	2.500	3.623	0.625	64	92	16	24801-1920	EQUAL	1.125	2.062	0.625	29	52	16
24801-1265	EQUAL	3.000	3.750	0.625	76	95	16	24801-1932	EQUAL	1.250	2.125	0.625	32	54	16
24801-1268	EQUAL	2.875	3.875	0.625	73	98	16	24801-1941	EQUAL	2.625	3.500	0.500	67	89	13
24801-1270	EQUAL	1.625	2.437	0.625	41	62	16	24801-1950	EQUAL	2.625	3.750	0.500	67	95	13
24801-1322	EQUAL	2.125	2.875	0.625	54	73	16	24801-1951	EQUAL	2.500	3.625	0.625	64	92	16
24801-1323	EQUAL	2.125	3.000	0.625	54	76	16	24801-1962	EQUAL	2.625	3.375	0.625	67	86	16
24801-1341	EQUAL	1.688	2.750	0.625	43	70	16	24801-1974	EQUAL	1.570	3.188	0.625	40	81	16
24801-1346	EQUAL	3.938	5.118	0.625	100	130	16	24801-1984	EQUAL	2.677	3.543	0.500	68	90	13
24801-1349	EQUAL	5.906	7.087	0.625	150	180	16	24801-1985	EQUAL	2.283	3.150	0.500	58	80	13
24801-1350	EQUAL	2.000	3.000	0.625	51	76	16	24801-1988	EQUAL	3.307	4.331	0.625	84	110	16
24801-1351	EQUAL	2.313	3.313	0.625	59	84	16	24801-2001	EQUAL	2.000	3.125	0.625	51	79	16
24801-1357	EQUAL	1.000	2.125	0.625	25	54	16	24801-2014	EQUAL	2.625	3.628	0.625	67	92	16
24801-1374	EQUAL	1.772	2.638	0.500	45	67	13	24801-2037	EQUAL	2.750	3.500	0.500	70	89	13
24801-1403	EQUAL	0.875	1.938	0.625	22	49	16	24801-2038	EQUAL	1.932	2.750	0.625	49	70	16
24801-1404	EQUAL	2.188	3.000	0.500	56	76	13	24801-2042	EQUAL	4.313	5.313	0.625	110	135	16
24801-1406	EQUAL	2.000	2.875	0.625	51	73	16	24801-2062	EQUAL	2.750	3.875	0.625	70	98	16
24801-1411	EQUAL	1.334	2.363	0.625	34	60	16	24801-2067	EQUAL	2.756	3.543	0.500	70	90	13
24801-1420	EQUAL	1.250	2.250	0.625	32	57	16	24801-2078	EQUAL	2.756	3.622	0.500	70	92	13
24801-1473	EQUAL	2.250	2.995	0.625	57	76	16	24801-2086	EQUAL	2.875	3.625	0.625	73	92	16
24801-1476	EQUAL	2.250	3.000	0.500	57	76	13	24801-2087	EQUAL	2.756	3.938	0.500	70	100	13
24801-1479	EQUAL	2.250	3.000	0.625	57	76	16	24801-2127	EQUAL	1.654	2.598	0.625	42	66	16
24801-1482	EQUAL	2.250	3.125	0.500	57	79	13	24801-2141	EQUAL	4.563	5.751	0.625	116	146	16
24801-1483	EQUAL	2.250	3.125	0.625	57	79	16	24801-2145	EQUAL	2.938	3.688	0.500	75	94	13
24801-1493	EQUAL	2.250	3.251	0.625	57	83	16	24801-2166	EQUAL	2.953	3.938	0.625	75	100	16
24801-1494	EQUAL	2.250	3.250	0.500	57	83	13	24801-2167	EQUAL	2.938	4.000	0.500	75	102	13
24801-1552	EQUAL	2.313	3.250	0.500	59	83	13	24801-2172	EQUAL	3.000	3.875	0.625	76	98	16
24801-1557	EQUAL	2.327	3.250	0.500	59	83	13	24801-2173	EQUAL	3.000	3.875	0.500	76	98	13
24801-1581	EQUAL	2.375	3.250	0.625	60	83	16	24801-2175	EQUAL	3.000	4.000	0.750	76	102	19
24801-1641	EQUAL	2.438	3.438	0.625	62	87	16	24801-2177	EQUAL	3.000	4.125	0.500	76	105	13
24801-1654	EQUAL	2.375	3.375	0.625	60	86	16	24801-2222	EQUAL	3.125	4.000	0.625	79	102	16
24801-1744	EQUAL	1.750	2.750	0.625	44	70	16	24801-2230	EQUAL	3.938	4.921	0.625	100	125	16
24801-1747	EQUAL	2.598	3.386	0.500	66	86	13	24801-2239	EQUAL	3.150	4.528	0.500	80	115	13
24801-1748	EQUAL	1.625	2.437	0.500	41	62	13	24801-2240	EQUAL	3.150	3.938	0.625	80	100	16
24801-1751	EQUAL	3.625	4.499	0.469	92	114	12	24801-2250	EQUAL	2.755	3.937	0.625	70	100	16
24801-1754	EQUAL	1.000	1.875	0.625	25	48	16	24801-2260	EQUAL	1.378	2.165	0.625	35	55	16
24801-1759	EQUAL	3.188	4.499	0.469	81	114	12	24801-2264	EQUAL	2.750	3.625	0.625	70	92	16
24801-1763	EQUAL	1.500	2.250	0.625	38	57	16	24801-2272	EQUAL	3.150	4.134	0.625	80	105	16
24801-1765	EQUAL	0.875	2.000	0.625	22	51	16	24801-2278	EQUAL	3.250	4.250	0.625	83	108	16
24801-1784	EQUAL	1.771	2.521	0.500	45	64	13	24801-2291	EQUAL	4.500	6.250	0.625	114	159	16
24801-1788	EQUAL	2.500	3.375	0.500	64	86	13	24801-2311	EQUAL	3.346	4.528	0.630	85	115	16
24801-1809	EQUAL	2.500	3.250	0.500	64	83	13	24801-2321	EQUAL	3.375	4.375	0.500	86	111	13
24801-1818	EQUAL	2.500	3.500	0.625	64	89	16	24801-2322	EQUAL	3.375	4.375	0.625	86	111	16
24801-1823	EQUAL	2.500	3.540	0.500	64	90	13	24801-2326	EQUAL	3.375	4.500	0.625	86	114	16
24801-1841	EQUAL	2.625	3.625	0.625	67	92	16	24801-2335	EQUAL	3.438	4.625	0.625	87	117	16
24801-1854	EQUAL	2.125	3.250	0.625	54	83	16	24801-2366	EQUAL	3.500	4.500	0.500	89	114	13
24801-1862	EQUAL	1.938	2.750	0.625	49	70	16	24801-2368	EQUAL	3.500	4.500	0.625	89	114	16
24801-1864	EQUAL	5.375	6.375	0.750	137	162	19	24801-2374	EQUAL	3.500	4.750	0.625	89	121	16
24801-1870	EQUAL	2.362	3.543	0.500	60	90	13	24801-2378	EQUAL	3.500	4.375	0.625	89	111	16
24801-1876	EQUAL	2.362	3.228	0.625	60	82	16	24801-2411	EQUAL	1.334	2.363	0.625	34	60	16
24801-1884	EQUAL	2.165	3.165	0.625	55	80	16	24801-2419	EQUAL	3.625	4.625	0.625	92	117	16
24801-1887	EQUAL	2.563	3.502	0.625	65	89	16	24801-2438	EQUAL	4.125	5.131	0.625	105	130	16
24801-1893	EQUAL	2.625	3.500	0.625	67	89	16	24801-2462	EQUAL	3.750	4.750	0.500	95	121	13
24801-1901	EQUAL	2.250	3.189	0.625	57	81	16	24801-2474	EQUAL	2.187	3.250	0.625	56	83	16
24801-1908	EQUAL	2.938	3.688	0.625	75	94	16	24801-2488	EQUAL	2.362	3.543	0.625	60	90	16
24801-1911	EQUAL	3.437	4.500	0.625	87	114	16	24801-2489	EQUAL	2.186	3.186	0.625	56	81	16
24801-1915	EQUAL	1.625	2.375	0.625	41	60	16	24801-2506	EQUAL	3.875	5.000	0.625	98	127	16

All dimensions are in inches. Preferred sizes are indicated with **bold** type face.

Sizes listed are for standard nitrile elements, except Models 25 and 62 which have PTFE elements. Other material available on inquiry only.

## Oil Seals by Model Number

Product Code	Model	Inches			MM			Product Code	Model	Inches			MM		
		ID	OD	Width	ID	OD	Width			ID	OD	Width	ID	OD	Width
24801-2510	EQUAL	4.750	5.756	0.625	121	146	16	24801-3430	EQUAL	6.500	7.750	0.625	165	197	16
24801-2533	EQUAL	3.938	4.875	0.500	100	124	13	24801-3455	EQUAL	2.438	3.431	0.625	62	87	16
24801-2577	EQUAL	3.438	4.438	0.625	87	113	16	24801-3464	EQUAL	6.750	8.250	0.625	171	210	16
24801-2593	EQUAL	4.000	5.000	0.625	102	127	16	24801-3474	EQUAL	3.938	5.250	0.625	100	133	16
24801-2604	EQUAL	4.125	5.125	0.625	105	130	16	24801-3491	EQUAL	2.438	3.500	0.625	62	89	16
24801-2611	EQUAL	1.654	2.559	0.625	42	65	16	24801-3506	EQUAL	1.875	2.758	0.625	48	70	16
24801-2612	EQUAL	4.125	5.625	0.500	105	143	13	24801-3518	EQUAL	7.250	8.250	0.625	184	210	16
24801-2625	EQUAL	4.134	5.118	0.625	105	130	16	24801-3584	EQUAL	3.346	4.528	0.551	85	115	14
24801-2631	EQUAL	1.575	3.150	0.625	40	80	16	24801-3588	EQUAL	7.875	9.375	0.625	200	238	16
24801-2659	EQUAL	4.250	5.250	0.625	108	133	16	24801-3593	EQUAL	3.150	4.331	0.625	80	110	16
24801-2672	EQUAL	4.250	5.875	0.625	108	149	16	24801-3596	EQUAL	8.000	9.250	0.625	203	235	16
24801-2676	EQUAL	2.813	3.751	0.625	71	95	16	24801-3628	EQUAL	1.575	2.500	0.625	40	64	16
24801-2694	EQUAL	1.375	2.437	0.625	35	62	16	24801-3632	EQUAL	0.938	1.837	0.625	24	47	16
24801-2698	EQUAL	1.235	2.000	0.625	31	51	16	24801-3642	EQUAL	3.000	3.938	0.625	76	100	16
24801-2720	EQUAL	1.437	2.437	0.625	36	62	16	24801-3785	EQUAL	5.000	6.375	0.625	127	162	16
24801-2723	EQUAL	1.688	2.688	0.625	43	68	16	24801-3790	EQUAL	4.935	6.000	0.625	125	152	16
24801-2753	EQUAL	4.500	5.500	0.500	114	140	13	24801-3796	EQUAL	1.063	1.938	0.625	27	49	16
24801-2755	EQUAL	4.500	5.500	0.625	114	140	16	24801-3830	EQUAL	3.938	4.875	0.625	100	124	16
24801-2759	EQUAL	4.500	5.750	0.500	114	146	13	24801-3913	EQUAL	6.299	7.480	0.625	160	190	16
24801-2761	EQUAL	4.500	5.750	0.625	114	146	16	24801-3964	EQUAL	0.750	1.575	0.625	19	40	16
24801-2766	EQUAL	5.188	6.188	0.625	132	157	16	24801-3971	EQUAL	1.500	3.045	0.625	38	77	16
24801-2780	EQUAL	4.528	5.512	0.625	115	140	16	24801-4195	EQUAL	2.520	4.250	0.625	64	108	16
24801-2808	EQUAL	4.625	5.625	0.625	117	143	16	24801-4444	EQUAL	2.158	3.150	0.625	55	80	16
24801-2851	EQUAL	4.750	6.250	0.625	121	159	16	24801-4568	EQUAL	0.512	1.606	0.625	13	41	16
24801-2874	EQUAL	4.250	5.375	0.625	108	137	16	24801-4631	EQUAL	2.500	4.250	0.625	64	108	16
24801-2875	EQUAL	4.875	6.000	0.625	124	152	16	24801-4639	EQUAL	1.375	2.828	0.625	35	72	16
24801-2885	EQUAL	4.437	5.500	0.625	113	140	16	24801-4651	EQUAL	4.000	5.000	0.500	102	127	13
24801-2902	EQUAL	3.543	4.724	0.625	90	120	16	24801-4682	EQUAL	4.705	5.750	0.625	120	146	16
24801-2918	EQUAL	1.654	2.441	0.625	42	62	16	24801-4947	EQUAL	1.969	2.835	0.630	50	72	16
24801-2919	EQUAL	2.756	3.543	0.625	70	90	16	24801-5047	EQUAL	3.188	4.249	0.625	81	108	16
24801-2923	EQUAL	5.000	6.250	0.625	127	159	16	24801-5048	EQUAL	4.375	5.500	0.625	111	140	16
24801-2930	EQUAL	4.921	6.890	0.625	125	175	16	24801-5088	EQUAL	5.315	6.496	0.625	135	165	16
24801-2931	EQUAL	4.750	5.750	0.625	121	146	16	24801-5089	EQUAL	4.921	6.102	0.625	125	155	16
24801-2948	EQUAL	4.560	6.125	0.625	116	156	16	24801-5140	EQUAL	5.512	6.496	0.625	140	165	16
24801-2962	EQUAL	3.938	5.000	0.625	100	127	16	24801-5164	EQUAL	4.591	5.508	0.625	117	140	16
24801-2969	EQUAL	1.969	3.189	0.625	50	81	16	24801-5223	EQUAL	0.748	1.496	0.625	19	38	16
24801-2987	EQUAL	1.625	2.500	0.625	41	64	16	24801-5269	EQUAL	3.150	5.118	0.625	80	130	16
24801-3021	EQUAL	3.740	4.724	0.625	95	120	16	24801-5309	EQUAL	4.133	5.511	0.625	105	140	16
24801-3061	EQUAL	2.500	3.725	0.625	64	95	16	24801-5325	EQUAL	0.787	1.654	0.625	20	42	16
24801-3063	EQUAL	5.250	6.256	0.625	133	159	16	24801-5370	EQUAL	3.375	3.952	0.375	86	100	10
24801-3071	EQUAL	1.719	2.625	0.625	44	67	16	24801-5416	EQUAL	0.669	1.575	0.625	17	40	16
24801-3143	EQUAL	1.838	2.750	0.625	47	70	16	24801-5431	EQUAL	2.362	3.150	0.625	60	80	16
24801-3161	EQUAL	2.441	3.346	0.630	62	85	16	24801-5446	EQUAL	1.181	2.030	0.625	30	52	16
24801-3164	EQUAL	4.810	6.000	0.625	122	152	16	24801-5488	EQUAL	2.441	3.346	0.625	62	85	16
24801-3165	EQUAL	4.788	6.000	0.625	122	152	16	24801-5521	EQUAL	3.346	4.724	0.625	85	120	16
24801-3178	EQUAL	5.500	6.500	0.625	140	165	16	24801-5593	EQUAL	0.984	1.969	0.625	25	50	16
24801-3184	EQUAL	5.500	6.750	0.625	140	171	16	24801-5732	EQUAL	2.250	3.312	0.625	57	84	16
24801-3223	EQUAL	2.160	3.250	0.625	55	83	16	24801-5785	EQUAL	2.500	3.438	0.625	64	87	16
24801-3225	EQUAL	1.969	2.756	0.625	50	70	16	24801-5792	EQUAL	5.250	6.250	0.625	133	159	16
24801-3239	EQUAL	2.313	3.062	0.625	59	78	16	24801-5944	EQUAL	2.250	3.750	0.625	57	95	16
24801-3241	EQUAL	1.573	3.250	0.625	40	83	16	24801-6438	EQUAL	2.688	4.000	0.625	68	102	16
24801-3263	EQUAL	0.945	1.732	0.625	24	44	16	24801-6702	EQUAL	3.346	4.331	0.625	85	110	16
24801-3267	EQUAL	2.313	3.750	0.625	59	95	16	24801-7682	EQUAL	3.125	4.250	0.625	79	108	16
24801-3357	EQUAL	6.000	7.000	0.625	152	178	16	24801-9724	EQUAL	3.000	4.250	0.625	76	108	16
24801-3366	EQUAL	2.250	3.625	0.625	57	92	16	24802-0706	EQUAL	1.875	3.000	0.625	48	76	16
24801-3398	EQUAL	1.000	1.750	0.625	25	44	16	24802-0709	EQUAL	2.125	2.875	0.500	54	73	13

All dimensions are in inches. Preferred sizes are indicated with **bold** type face.  
 Sizes listed are for standard nitrile elements, except Models 25 and 62 which have PTFE elements. Other material available on inquiry only.

## Oil Seals by Model Number

Product Code	Model	Inches			MM			Product Code	Model	Inches			MM		
		ID	OD	Width	ID	OD	Width			ID	OD	Width	ID	OD	Width
24802-0748	EQUAL	1.875	2.625	0.500	48	67	13	24802-1197	EQUAL	1.968	2.953	0.625	50	75	16
24802-0754	EQUAL	1.375	2.500	0.625	35	64	16	24802-1199	EQUAL	1.181	2.358	0.625	30	60	16
24802-0765	EQUAL	1.125	2.001	0.500	29	51	13	24802-1203	EQUAL	2.625	3.489	0.625	67	89	16
24802-0770	EQUAL	1.625	2.750	0.625	41	70	16	24802-1205	EQUAL	2.875	4.003	0.625	73	102	16
24802-0787	EQUAL	1.250	2.375	0.625	32	60	16	24802-1207	EQUAL	3.125	4.130	0.625	79	105	16
24802-0792	EQUAL	1.875	2.875	0.625	48	73	16	24802-1209	EQUAL	3.313	4.130	0.625	84	105	16
24802-0811	EQUAL	4.250	5.500	0.625	108	140	16	24802-1211	EQUAL	2.375	3.500	0.625	60	89	16
24802-0815	EQUAL	1.125	2.250	0.625	29	57	16	24802-1212	EQUAL	2.500	3.375	0.625	64	86	16
24802-0832	EQUAL	1.125	2.125	0.625	29	54	16	24802-1214	EQUAL	1.500	2.375	0.625	38	60	16
24802-0988	EQUAL	1.125	2.001	0.625	29	51	16	24802-1215	EQUAL	1.250	2.000	0.625	32	51	16
24802-0989	EQUAL	1.875	2.625	0.625	48	67	16	24802-1216	EQUAL	3.000	3.881	0.625	76	99	16
24802-0991	EQUAL	2.500	3.251	0.625	64	83	16	24802-1220	EQUAL	3.000	4.000	0.625	76	102	16
24802-0997	EQUAL	2.938	4.003	0.625	75	102	16	24802-1225	EQUAL	2.063	3.000	0.625	52	76	16
24802-0998	EQUAL	1.750	2.875	0.625	44	73	16	24802-1237	EQUAL	3.250	4.003	0.625	83	102	16
24802-1010	EQUAL	2.125	3.189	0.625	54	81	16	24802-1238	EQUAL	2.750	3.500	0.625	70	89	16
24802-1012	EQUAL	0.875	1.625	0.625	22	41	16	24802-1239	EQUAL	7.250	8.750	0.625	184	222	16
24802-1024	EQUAL	6.000	7.500	0.625	152	191	16	24802-1242	EQUAL	2.750	3.543	0.625	70	90	16
24802-1026	EQUAL	1.750	2.500	0.625	44	64	16	24802-1245	EQUAL	2.250	3.375	0.625	57	86	16
24802-1028	EQUAL	3.250	4.000	0.625	83	102	16	24802-1248	EQUAL	2.125	3.520	0.625	54	89	16
24802-1058	EQUAL	2.438	3.346	0.500	62	85	13	24802-1249	EQUAL	2.000	2.750	0.625	51	70	16
24802-1062	EQUAL	1.750	2.625	0.625	44	67	16	24802-1250	EQUAL	2.750	3.750	0.625	70	95	16
24802-1075	EQUAL	1.875	2.750	0.625	48	70	16	24802-1251	EQUAL	2.563	3.563	0.625	65	91	16
24802-1080	EQUAL	3.625	4.375	0.625	92	111	16	24802-1265	EQUAL	3.000	3.750	0.625	76	95	16
24802-1081	EQUAL	2.875	3.750	0.625	73	95	16	24802-1267	EQUAL	1.570	2.338	0.625	40	59	16
24802-1082	EQUAL	4.331	5.512	0.625	110	140	16	24802-1268	EQUAL	2.875	3.875	0.625	73	98	16
24802-1083	EQUAL	1.000	2.000	0.625	25	51	16	24802-1270	EQUAL	1.625	2.438	0.625	41	62	16
24802-1086	EQUAL	2.625	3.677	0.625	67	93	16	24802-1312	EQUAL	3.750	4.625	0.625	95	117	16
24802-1087	EQUAL	2.625	3.688	0.625	67	94	16	24802-1322	EQUAL	2.125	2.875	0.625	54	73	16
24802-1089	EQUAL	1.625	2.625	0.625	41	67	16	24802-1323	EQUAL	2.125	3.000	0.625	54	76	16
24802-1090	EQUAL	0.875	1.750	0.625	22	44	16	24802-1328	EQUAL	0.625	1.375	0.625	16	35	16
24802-1091	EQUAL	1.125	3.150	0.625	29	80	16	24802-1340	EQUAL	2.165	3.000	0.625	55	76	16
24802-1092	EQUAL	1.375	2.125	0.625	35	54	16	24802-1341	EQUAL	1.688	2.750	0.625	43	70	16
24802-1095	EQUAL	3.750	5.250	0.625	95	133	16	24802-1346	EQUAL	3.938	5.118	0.625	100	130	16
24802-1100	EQUAL	1.427	2.500	0.625	36	64	16	24802-1347	EQUAL	3.938	4.724	0.625	100	120	16
24802-1101	EQUAL	1.375	2.375	0.625	35	60	16	24802-1348	EQUAL	2.362	3.150	0.625	60	80	16
24802-1105	EQUAL	1.375	3.125	0.625	35	79	16	24802-1349	EQUAL	5.906	7.087	0.625	150	180	16
24802-1110	EQUAL	1.062	1.813	0.625	27	46	16	24802-1350	EQUAL	2.000	3.000	0.625	51	76	16
24802-1115	EQUAL	0.938	1.688	0.625	24	43	16	24802-1351	EQUAL	2.313	3.313	0.625	59	84	16
24802-1116	EQUAL	1.437	2.250	0.625	36	57	16	24802-1353	EQUAL	2.188	3.189	0.625	56	81	16
24802-1119	EQUAL	2.188	3.000	0.625	56	76	16	24802-1357	EQUAL	1.000	2.125	0.625	25	54	16
24802-1121	EQUAL	1.375	2.250	0.625	35	57	16	24802-1398	EQUAL	1.873	2.813	0.625	48	71	16
24802-1123	EQUAL	1.938	3.000	0.625	49	76	16	24802-1403	EQUAL	0.875	1.938	0.625	22	49	16
24802-1138	EQUAL	1.375	2.835	0.625	35	72	16	24802-1405	EQUAL	0.750	1.499	0.625	19	38	16
24802-1139	EQUAL	1.465	2.344	0.625	37	60	16	24802-1406	EQUAL	2.000	2.875	0.625	51	73	16
24802-1141	EQUAL	1.938	2.813	0.625	49	71	16	24802-1411	EQUAL	1.334	2.363	0.625	34	60	16
24802-1142	EQUAL	2.938	3.813	0.625	75	97	16	24802-1420	EQUAL	1.250	2.250	0.625	32	57	16
24802-1144	EQUAL	3.938	4.938	0.625	100	125	16	24802-1479	EQUAL	2.250	3.000	0.625	57	76	16
24802-1152	EQUAL	1.125	1.875	0.625	29	48	16	24802-1483	EQUAL	2.250	3.125	0.625	57	79	16
24802-1162	EQUAL	2.625	3.750	0.625	67	95	16	24802-1493	EQUAL	2.250	3.250	0.625	57	83	16
24802-1166	EQUAL	1.500	2.625	0.625	38	67	16	24802-1494	EQUAL	2.250	3.250	0.500	57	83	13
24802-1174	EQUAL	3.563	4.751	0.625	91	121	16	24802-1498	EQUAL	2.250	3.350	0.625	57	85	16
24802-1176	EQUAL	2.062	2.996	0.625	52	76	16	24802-1499	EQUAL	1.181	2.211	0.625	30	56	16
24802-1180	EQUAL	2.250	3.188	0.625	57	81	16	24802-1581	EQUAL	2.375	3.250	0.625	60	83	16
24802-1183	EQUAL	9.750	11.250	1.000	248	286	25	24802-1641	EQUAL	2.437	3.437	0.625	62	87	16
24802-1185	EQUAL	6.500	8.000	1.000	165	203	25	24802-1645	EQUAL	2.375	3.125	0.625	60	79	16
24802-1194	EQUAL	1.500	2.499	0.625	38	63	16	24802-1654	EQUAL	2.375	3.375	0.625	60	86	16

All dimensions are in inches. Preferred sizes are indicated with **bold** type face.

Sizes listed are for standard nitrile elements, except Models 25 and 62 which have PTFE elements. Other material available on inquiry only.

## Oil Seals by Model Number

Product Code	Model	Inches			MM			Product Code	Model	Inches			MM		
		ID	OD	Width	ID	OD	Width			ID	OD	Width	ID	OD	Width
24802-1739	EQUAL	3.149	3.942	0.625	80	100	16	24802-1943	EQUAL	2.356	3.625	0.625	60	92	16
24802-1740	EQUAL	2.628	3.750	0.625	67	95	16	24802-1951	EQUAL	2.500	3.625	0.625	64	92	16
24802-1743	EQUAL	1.938	2.875	0.625	49	73	16	24802-1958	EQUAL	1.438	2.375	0.625	37	60	16
24802-1744	EQUAL	1.750	2.750	0.625	44	70	16	24802-1960	EQUAL	4.188	5.875	0.625	106	149	16
24802-1752	EQUAL	1.378	2.362	0.625	35	60	16	24802-1961	EQUAL	3.875	5.500	0.625	98	140	16
24802-1754	EQUAL	1.000	1.875	0.625	25	48	16	24802-1962	EQUAL	2.625	3.375	0.625	67	86	16
24802-1755	EQUAL	2.250	3.500	0.625	57	89	16	24802-1975	EQUAL	1.969	3.150	0.625	50	80	16
24802-1760	EQUAL	1.968	2.875	0.625	50	73	16	24802-1980	EQUAL	2.938	3.750	0.625	75	95	16
24802-1761	EQUAL	2.125	3.125	0.625	54	79	16	24802-1981	EQUAL	2.244	3.268	0.625	57	83	16
24802-1763	EQUAL	1.500	2.250	0.625	38	57	16	24802-1982	EQUAL	2.813	3.580	0.625	71	91	16
24802-1764	EQUAL	6.250	7.125	0.625	159	181	16	24802-1988	EQUAL	3.307	4.331	0.625	84	110	16
24802-1765	EQUAL	0.875	2.000	0.625	22	51	16	24802-2001	EQUAL	2.000	3.125	0.625	51	79	16
24802-1766	EQUAL	2.313	3.250	0.625	59	83	16	24802-2003	EQUAL	2.688	3.500	0.625	68	89	16
24802-1768	EQUAL	4.188	5.004	0.625	106	127	16	24802-2005	EQUAL	2.165	3.150	0.625	55	80	16
24802-1776	EQUAL	2.375	3.350	0.625	60	85	16	24802-2010	EQUAL	2.717	3.752	0.625	69	95	16
24802-1779	EQUAL	1.560	2.590	0.625	40	66	16	24802-2028	EQUAL	0.807	2.165	0.625	20	55	16
24802-1803	EQUAL	1.574	2.575	0.625	40	65	16	24802-2038	EQUAL	1.932	2.750	0.625	49	70	16
24802-1804	EQUAL	1.771	2.996	0.625	45	76	16	24802-2046	EQUAL	3.938	5.501	0.625	100	140	16
24802-1805	EQUAL	2.165	3.189	0.625	55	81	16	24802-2048	EQUAL	4.875	5.875	0.625	124	149	16
24802-1806	EQUAL	2.362	3.362	0.625	60	85	16	24802-2050	EQUAL	4.375	5.375	0.625	111	137	16
24802-1807	EQUAL	2.559	3.500	0.625	65	89	16	24802-2051	EQUAL	4.563	5.563	0.625	116	141	16
24802-1810	EQUAL	2.755	3.750	0.625	70	95	16	24802-2059	EQUAL	2.756	3.543	0.625	70	90	16
24802-1811	EQUAL	2.952	4.000	0.625	75	102	16	24802-2062	EQUAL	2.750	3.875	0.625	70	98	16
24802-1813	EQUAL	3.149	4.500	0.625	80	114	16	24802-2083	EQUAL	2.938	3.938	0.625	75	100	16
24802-1814	EQUAL	3.346	4.375	0.625	85	111	16	24802-2086	EQUAL	2.875	3.625	0.625	73	92	16
24802-1815	EQUAL	3.543	4.500	0.625	90	114	16	24802-2091	EQUAL	3.000	4.500	0.625	76	114	16
24802-1816	EQUAL	3.740	4.750	0.625	95	121	16	24802-2106	EQUAL	4.188	5.500	0.625	106	140	16
24802-1817	EQUAL	4.330	5.250	0.625	110	133	16	24802-2107	EQUAL	1.437	2.500	0.625	36	64	16
24802-1818	EQUAL	2.500	3.500	0.625	64	89	16	24802-2108	EQUAL	1.938	3.125	0.625	49	79	16
24802-1834	EQUAL	2.500	4.375	0.625	64	111	16	24802-2115	EQUAL	2.062	3.125	0.625	52	79	16
24802-1840	EQUAL	4.443	5.500	0.625	113	140	16	24802-2160	EQUAL	1.000	2.441	0.625	25	62	16
24802-1841	EQUAL	2.625	3.625	0.625	67	92	16	24802-2166	EQUAL	2.953	3.938	0.625	75	100	16
24802-1849	EQUAL	2.125	3.050	0.625	54	77	16	24802-2171	EQUAL	3.000	4.008	0.625	76	102	16
24802-1850	EQUAL	1.188	2.441	0.625	30	62	16	24802-2172	EQUAL	3.000	3.875	0.625	76	98	16
24802-1854	EQUAL	2.125	3.250	0.625	54	83	16	24802-2179	EQUAL	3.000	4.125	0.625	76	105	16
24802-1858	EQUAL	2.559	3.465	0.625	65	88	16	24802-2195	EQUAL	1.250	2.875	0.625	32	73	16
24802-1862	EQUAL	1.938	2.750	0.625	49	70	16	24802-2201	EQUAL	3.062	4.062	0.625	78	103	16
24802-1872	EQUAL	1.500	2.460	0.625	38	62	16	24802-2209	EQUAL	3.122	4.000	0.625	79	102	16
24802-1874	EQUAL	1.500	2.410	0.625	38	61	16	24802-2210	EQUAL	3.750	4.500	0.625	95	114	16
24802-1876	EQUAL	2.362	3.228	0.625	60	82	16	24802-2223	EQUAL	3.125	4.125	0.625	79	105	16
24802-1878	EQUAL	2.875	4.380	0.625	73	111	16	24802-2224	EQUAL	3.125	4.375	0.625	79	111	16
24802-1882	EQUAL	3.500	4.625	0.625	89	117	16	24802-2230	EQUAL	3.938	4.921	0.625	100	125	16
24802-1883	EQUAL	2.559	3.543	0.625	65	90	16	24802-2240	EQUAL	3.150	3.938	0.625	80	100	16
24802-1884	EQUAL	2.165	3.165	0.625	55	80	16	24802-2250	EQUAL	2.756	3.938	0.625	70	100	16
24802-1887	EQUAL	2.563	3.502	0.625	65	89	16	24802-2260	EQUAL	1.378	2.165	0.625	35	55	16
24802-1891	EQUAL	1.875	2.997	0.625	48	76	16	24802-2261	EQUAL	3.526	4.526	0.625	90	115	16
24802-1893	EQUAL	2.625	3.500	0.625	67	89	16	24802-2264	EQUAL	2.750	3.625	0.625	70	92	16
24802-1898	EQUAL	1.781	3.125	0.625	45	79	16	24802-2270	EQUAL	5.250	6.250	0.625	133	159	16
24802-1901	EQUAL	2.250	3.189	0.625	57	81	16	24802-2280	EQUAL	3.250	4.250	0.625	83	108	16
24802-1906	EQUAL	2.165	3.543	0.625	55	90	16	24802-2286	EQUAL	3.250	4.375	0.625	83	111	16
24802-1911	EQUAL	3.437	4.500	0.625	87	114	16	24802-2288	EQUAL	1.475	2.335	0.625	37	59	16
24802-1915	EQUAL	1.625	2.375	0.625	41	60	16	24802-2292	EQUAL	1.766	2.750	0.625	45	70	16
24802-1929	EQUAL	1.375	2.438	0.625	35	62	16	24802-2296	EQUAL	3.313	4.125	0.625	84	105	16
24802-1932	EQUAL	1.250	2.125	0.625	32	54	16	24802-2304	EQUAL	3.313	4.500	0.625	84	114	16
24802-1935	EQUAL	1.890	2.756	0.625	48	70	16	24802-2312	EQUAL	2.280	3.280	0.625	58	83	16
24802-1942	EQUAL	2.438	3.250	0.625	62	83	16	24802-2316	EQUAL	3.375	4.250	0.625	86	108	16

All dimensions are in inches. Preferred sizes are indicated with **bold** type face. Sizes listed are for standard nitrile elements, except Models 25 and 62 which have PTFE elements. Other material available on inquiry only.

## Oil Seals by Model Number

Product Code	Model	Inches			MM			Product Code	Model	Inches			MM		
		ID	OD	Width	ID	OD	Width			ID	OD	Width	ID	OD	Width
24802-2322	EQUAL	3.375	4.375	0.625	86	111	16	24802-2859	EQUAL	1.125	2.441	0.625	29	62	16
24802-2326	EQUAL	3.375	4.500	0.625	86	114	16	24802-2874	EQUAL	4.250	5.375	0.625	108	137	16
24802-2332	EQUAL	3.408	4.500	0.625	87	114	16	24802-2875	EQUAL	4.875	6.000	0.625	124	152	16
24802-2335	EQUAL	3.438	4.626	0.625	87	118	16	24802-2885	EQUAL	4.437	5.500	0.625	113	140	16
24802-2368	EQUAL	3.500	4.500	0.625	89	114	16	24802-2891	EQUAL	3.938	4.900	0.625	100	124	16
24802-2374	EQUAL	3.500	4.750	0.625	89	121	16	24802-2896	EQUAL	4.938	6.000	0.625	125	152	16
24802-2378	EQUAL	3.500	4.375	0.625	89	111	16	24802-2897	EQUAL	2.264	3.250	0.625	58	83	16
24802-2419	EQUAL	3.625	4.625	0.625	92	117	16	24802-2902	EQUAL	3.543	4.724	0.625	90	120	16
24802-2464	EQUAL	3.750	4.750	0.625	95	121	16	24802-2904	EQUAL	5.438	6.688	0.625	138	170	16
24802-2474	EQUAL	2.188	3.250	0.625	56	83	16	24802-2917	EQUAL	5.000	6.000	0.625	127	152	16
24802-2476	EQUAL	1.181	2.350	0.625	30	60	16	24802-2920	EQUAL	1.908	2.875	0.625	48	73	16
24802-2480	EQUAL	1.968	2.935	0.625	50	75	16	24802-2923	EQUAL	5.000	6.250	0.625	127	159	16
24802-2483	EQUAL	3.750	5.000	0.625	95	127	16	24802-2924	EQUAL	5.000	6.256	0.625	127	159	16
24802-2489	EQUAL	2.186	3.186	0.625	56	81	16	24802-2931	EQUAL	4.750	5.750	0.625	121	146	16
24802-2492	EQUAL	3.000	4.617	0.625	76	117	16	24802-2942	EQUAL	3.938	4.883	0.625	100	124	16
24802-2503	EQUAL	3.875	4.875	0.625	98	124	16	24802-2944	EQUAL	3.450	4.500	0.625	88	114	16
24802-2506	EQUAL	3.875	5.000	0.625	98	127	16	24802-2949	EQUAL	4.599	5.599	0.625	117	142	16
24802-2520	EQUAL	2.625	3.371	0.625	67	86	16	24802-2950	EQUAL	3.006	4.006	0.625	76	102	16
24802-2523	EQUAL	3.346	4.134	0.625	85	105	16	24802-2957	EQUAL	2.750	4.000	0.625	70	102	16
24802-2527	EQUAL	3.600	5.000	0.625	91	127	16	24802-2971	EQUAL	1.571	2.571	0.625	40	65	16
24802-2539	EQUAL	4.938	5.938	0.625	125	151	16	24802-2972	EQUAL	3.740	5.118	0.625	95	130	16
24802-2542	EQUAL	4.000	5.125	0.625	102	130	16	24802-2974	EQUAL	4.331	5.331	0.625	110	135	16
24802-2577	EQUAL	3.438	4.438	0.625	87	113	16	24802-2986	EQUAL	5.088	6.088	0.625	129	155	16
24802-2593	EQUAL	4.000	5.000	0.625	102	127	16	24802-2987	EQUAL	1.625	2.500	0.625	41	64	16
24802-2604	EQUAL	4.125	5.125	0.625	105	130	16	24802-2998	EQUAL	5.125	6.375	0.625	130	162	16
24802-2605	EQUAL	4.125	5.250	0.625	105	133	16	24802-2999	EQUAL	2.125	3.313	0.625	54	84	16
24802-2616	EQUAL	4.125	5.750	0.625	105	146	16	24802-3002	EQUAL	1.437	2.310	0.625	36	59	16
24802-2618	EQUAL	2.350	3.350	0.625	60	85	16	24802-3004	EQUAL	2.500	3.433	0.625	64	87	16
24802-2622	EQUAL	1.375	2.875	0.625	35	73	16	24802-3005	EQUAL	3.188	4.313	0.625	81	110	16
24802-2623	EQUAL	4.188	5.256	0.625	106	134	16	24802-3006	EQUAL	2.375	3.437	0.625	60	87	16
24802-2625	EQUAL	4.134	5.118	0.625	105	130	16	24802-3007	EQUAL	2.500	3.563	0.625	64	91	16
24802-2629	EQUAL	4.134	5.134	0.625	105	130	16	24802-3009	EQUAL	3.250	4.313	0.625	83	110	16
24802-2632	EQUAL	2.313	3.500	0.625	59	89	16	24802-3012	EQUAL	2.755	3.755	0.625	70	95	16
24802-2634	EQUAL	2.750	4.125	0.625	70	105	16	24802-3015	EQUAL	2.174	3.174	0.625	55	81	16
24802-2635	EQUAL	2.656	4.003	0.625	67	102	16	24802-3016	EQUAL	2.569	3.569	0.625	65	91	16
24802-2643	EQUAL	3.075	4.325	0.625	78	110	16	24802-3017	EQUAL	3.201	4.201	0.625	81	107	16
24802-2659	EQUAL	4.250	5.250	0.625	108	133	16	24802-3018	EQUAL	3.948	4.948	0.625	100	126	16
24802-2662	EQUAL	2.500	3.543	0.625	64	90	16	24802-3021	EQUAL	3.740	4.724	0.625	95	120	16
24802-2689	EQUAL	4.313	5.750	0.625	110	146	16	24802-3022	EQUAL	5.118	6.299	0.625	130	160	16
24802-2694	EQUAL	1.375	2.437	0.625	35	62	16	24802-3023	EQUAL	2.677	3.543	0.625	68	90	16
24802-2698	EQUAL	1.235	2.000	0.625	31	51	16	24802-3024	EQUAL	3.071	3.937	0.625	78	100	16
24802-2700	EQUAL	4.313	5.500	0.625	110	140	16	24802-3025	EQUAL	2.283	3.543	0.625	58	90	16
24802-2711	EQUAL	0.875	1.875	0.625	22	48	16	24802-3029	EQUAL	1.563	2.500	0.625	40	64	16
24802-2720	EQUAL	1.438	2.438	0.625	37	62	16	24802-3038	EQUAL	4.255	5.255	0.625	108	133	16
24802-2730	EQUAL	1.938	2.938	0.625	49	75	16	24802-3039	EQUAL	3.786	4.786	0.625	96	122	16
24802-2735	EQUAL	2.063	3.063	0.625	52	78	16	24802-3045	EQUAL	3.346	4.321	0.625	85	110	16
24802-2736	EQUAL	2.688	3.688	0.625	68	94	16	24802-3048	EQUAL	1.500	2.563	0.625	38	65	16
24802-2740	EQUAL	4.450	5.325	0.625	113	135	16	24802-3052	EQUAL	2.160	3.160	0.625	55	80	16
24802-2744	EQUAL	3.688	4.688	0.625	94	119	16	24802-3054	EQUAL	2.153	3.153	0.625	55	80	16
24802-2747	EQUAL	4.188	5.188	0.625	106	132	16	24802-3056	EQUAL	2.222	3.222	0.625	56	82	16
24802-2755	EQUAL	4.500	5.500	0.625	114	140	16	24802-3058	EQUAL	2.125	3.500	0.625	54	89	16
24802-2780	EQUAL	4.527	5.512	0.625	115	140	16	24802-3062	EQUAL	4.680	6.000	0.625	119	152	16
24802-2808	EQUAL	4.625	5.625	0.625	117	143	16	24802-3064	EQUAL	2.380	3.380	0.625	60	86	16
24802-2816	EQUAL	2.559	3.346	0.625	65	85	16	24802-3067	EQUAL	5.250	6.500	0.625	133	165	16
24802-2843	EQUAL	2.875	4.000	0.625	73	102	16	24802-3072	EQUAL	3.735	4.735	0.625	95	120	16
24802-2857	EQUAL	1.185	2.442	0.625	30	62	16	24802-3073	EQUAL	5.250	6.750	0.625	133	171	16

All dimensions are in inches. Preferred sizes are indicated with **bold** type face. Sizes listed are for standard nitrile elements, except Models 25 and 62 which have PTFE elements. Other material available on inquiry only.

## Oil Seals by Model Number

Product Code	Model	Inches			MM			Product Code	Model	Inches			MM		
		ID	OD	Width	ID	OD	Width			ID	OD	Width	ID	OD	Width
24802-3083	EQUAL	2.060	3.060	0.625	52	78	16	24802-3357	EQUAL	6.000	7.000	0.625	152	178	16
24802-3086	EQUAL	2.933	3.750	0.625	74	95	16	24802-3366	EQUAL	2.250	3.625	0.625	57	92	16
24802-3087	EQUAL	1.378	3.150	0.625	35	80	16	24802-3388	EQUAL	1.181	2.181	0.625	30	55	16
24802-3088	EQUAL	0.866	1.969	0.625	22	50	16	24802-3398	EQUAL	1.000	1.750	0.625	25	44	16
24802-3093	EQUAL	2.875	4.625	0.625	73	117	16	24802-3424	EQUAL	6.437	7.688	0.625	163	195	16
24802-3094	EQUAL	4.335	5.335	0.625	110	136	16	24802-3474	EQUAL	3.938	5.251	0.625	100	133	16
24802-3095	EQUAL	5.115	6.115	0.625	130	155	16	24802-3480	EQUAL	2.313	3.371	0.625	59	86	16
24802-3096	EQUAL	3.015	4.015	0.625	77	102	16	24802-3491	EQUAL	2.438	3.500	0.625	62	89	16
24802-3099	EQUAL	2.505	3.505	0.625	64	89	16	24802-3493	EQUAL	2.932	3.806	0.625	74	97	16
24802-3101	EQUAL	3.385	4.385	0.625	86	111	16	24802-3498	EQUAL	1.574	3.938	0.625	40	100	16
24802-3104	EQUAL	3.900	4.900	0.625	99	124	16	24802-3506	EQUAL	1.875	2.758	0.625	48	70	16
24802-3105	EQUAL	4.540	6.150	0.625	115	156	16	24802-3513	EQUAL	2.932	3.932	0.625	74	100	16
24802-3107	EQUAL	2.755	3.741	0.625	70	95	16	24802-3514	EQUAL	2.650	3.630	0.625	67	92	16
24802-3108	EQUAL	2.402	3.290	0.625	61	84	16	24802-3519	EQUAL	2.950	3.960	0.625	75	101	16
24802-3109	EQUAL	3.228	4.448	0.625	82	113	16	24802-3524	EQUAL	1.980	2.875	0.625	50	73	16
24802-3137	EQUAL	2.900	3.900	0.625	74	99	16	24802-3540	EQUAL	2.360	4.090	0.625	60	104	16
24802-3138	EQUAL	3.010	4.010	0.625	76	102	16	24802-3541	EQUAL	2.000	2.884	0.625	51	73	16
24802-3139	EQUAL	3.335	4.335	0.625	85	110	16	24802-3552	EQUAL	7.500	9.000	0.625	191	229	16
24802-3153	EQUAL	2.230	3.230	0.625	57	82	16	24802-3560	EQUAL	2.000	2.855	0.625	51	73	16
24802-3154	EQUAL	2.440	3.440	0.625	62	87	16	24802-3568	EQUAL	2.480	3.543	0.625	63	90	16
24802-3161	EQUAL	3.346	4.330	0.625	85	110	16	24802-3570	EQUAL	3.000	4.003	0.625	76	102	16
24802-3162	EQUAL	5.315	6.693	0.625	135	170	16	24802-3576	EQUAL	1.625	2.800	0.625	41	71	16
24802-3168	EQUAL	4.565	5.565	0.625	116	141	16	24802-3577	EQUAL	2.307	4.331	0.625	59	110	16
24802-3169	EQUAL	2.150	3.150	0.625	55	80	16	24802-3582	EQUAL	2.313	3.438	0.625	59	87	16
24802-3170	EQUAL	2.560	3.560	0.625	65	90	16	24802-3593	EQUAL	3.150	4.331	0.625	80	110	16
24802-3174	EQUAL	2.750	4.375	0.625	70	111	16	24802-3600	EQUAL	1.969	3.543	0.625	50	90	16
24802-3179	EQUAL	4.725	5.906	0.625	120	150	16	24802-3628	EQUAL	1.575	2.500	0.625	40	64	16
24802-3180	EQUAL	6.693	7.875	0.625	170	200	16	24802-3646	EQUAL	3.375	5.290	0.625	86	134	16
24802-3184	EQUAL	5.500	6.750	0.625	140	171	16	24802-3650	EQUAL	2.625	3.683	0.625	67	94	16
24802-3210	EQUAL	4.230	5.230	0.625	107	133	16	24802-3735	EQUAL	2.559	3.620	0.625	65	92	16
24802-3221	EQUAL	2.998	3.998	0.625	76	102	16	24802-3736	EQUAL	2.950	4.250	0.625	75	108	16
24802-3224	EQUAL	4.245	5.245	0.625	108	133	16	24802-3745	EQUAL	1.889	2.889	0.625	48	73	16
24802-3234	EQUAL	2.550	3.550	0.625	65	90	16	24802-3753	EQUAL	3.437	5.125	0.625	87	130	16
24802-3236	EQUAL	5.625	6.875	0.625	143	175	16	24802-3772	EQUAL	1.161	2.000	0.625	29	51	16
24802-3240	EQUAL	3.563	4.500	0.625	91	114	16	24802-3777	EQUAL	3.188	5.000	0.625	81	127	16
24802-3244	EQUAL	2.563	4.125	0.625	65	105	16	24802-3785	EQUAL	5.000	6.375	0.625	127	162	16
24802-3251	EQUAL	4.425	5.626	0.625	112	143	16	24802-3802	EQUAL	7.469	8.469	0.625	190	215	16
24802-3257	EQUAL	1.750	2.716	0.625	44	69	16	24802-3966	EQUAL	3.313	4.375	0.625	84	111	16
24802-3263	EQUAL	0.945	1.732	0.625	24	44	16	24802-3975	EQUAL	1.750	3.125	0.625	44	79	16
24802-3264	EQUAL	1.886	2.886	0.625	48	73	16	24802-3983	EQUAL	3.934	4.934	0.625	100	125	16
24802-3265	EQUAL	3.543	4.331	0.625	90	110	16	24802-3986	EQUAL	2.428	3.428	0.625	62	87	16
24802-3266	EQUAL	1.967	2.967	0.625	50	75	16	24802-3989	EQUAL	2.756	4.331	0.625	70	110	16
24802-3268	EQUAL	1.563	2.437	0.625	40	62	16	24802-4057	EQUAL	2.062	3.625	0.625	52	92	16
24802-3277	EQUAL	5.750	6.750	0.625	146	171	16	24802-4091	EQUAL	3.938	5.315	0.625	100	135	16
24802-3282	EQUAL	4.245	5.626	0.625	108	143	16	24802-4096	EQUAL	1.378	2.545	0.625	35	65	16
24802-3284	EQUAL	1.493	2.493	0.625	38	63	16	24802-4102	EQUAL	1.496	2.496	0.625	38	63	16
24802-3290	EQUAL	1.932	2.932	0.625	49	74	16	24802-4103	EQUAL	2.065	3.065	0.625	52	78	16
24802-3294	EQUAL	2.438	3.350	0.625	62	85	16	24802-4136	EQUAL	3.522	4.500	0.625	89	114	16
24802-3299	EQUAL	3.345	4.304	0.625	85	109	16	24802-4201	EQUAL	2.205	3.150	0.625	56	80	16
24802-3309	EQUAL	2.362	3.346	0.625	60	85	16	24802-4202	EQUAL	1.563	2.750	0.625	40	70	16
24802-3316	EQUAL	2.953	3.740	0.625	75	95	16	24802-4341	EQUAL	1.177	2.441	0.625	30	62	16
24802-3318	EQUAL	4.331	5.118	0.625	110	130	16	24802-4342	EQUAL	1.177	2.500	0.625	30	64	16
24802-3321	EQUAL	1.625	2.375	0.625	41	60	16	24802-4346	EQUAL	1.500	2.545	0.625	38	65	16
24802-3334	EQUAL	3.402	4.375	0.625	86	111	16	24802-4358	EQUAL	2.437	3.481	0.625	62	88	16
24802-3344	EQUAL	3.438	4.313	0.625	87	110	16	24802-4392	EQUAL	2.313	3.625	0.625	59	92	16
24802-3349	EQUAL	2.000	3.000	0.750	51	76	19	24802-4415	EQUAL	1.125	2.188	0.625	29	56	16

All dimensions are in inches. Preferred sizes are indicated with **bold** type face. Sizes listed are for standard nitrile elements, except Models 25 and 62 which have PTFE elements. Other material available on inquiry only.

## Oil Seals by Model Number

Product Code	Model	Inches			MM			Product Code	Model	Inches			MM		
		ID	OD	Width	ID	OD	Width			ID	OD	Width	ID	OD	Width
24802-4447	EQUAL	2.166	3.938	0.625	55	100	16	24803-1081	EQUAL	2.875	3.750	0.625	73	95	16
24802-4456	EQUAL	1.437	2.125	0.625	36	54	16	24803-1194	EQUAL	1.500	2.500	0.625	38	64	16
24802-4469	EQUAL	2.726	3.726	0.625	69	95	16	24803-1220	EQUAL	3.000	4.000	0.625	76	102	16
24802-4521	EQUAL	1.932	2.806	0.625	49	71	16	24803-1322	EQUAL	2.125	2.875	0.625	54	73	16
24802-4563	EQUAL	0.985	1.850	0.625	25	47	16	24803-1493	EQUAL	2.250	3.250	0.625	57	83	16
24802-4568	EQUAL	0.512	1.606	0.625	13	41	16	24803-1668	EQUAL	2.375	3.500	0.500	60	89	13
24802-4596	EQUAL	0.787	1.575	0.625	20	40	16	24803-1744	EQUAL	1.750	2.750	0.625	44	70	16
24802-4597	EQUAL	2.433	4.049	0.625	62	103	16	24803-1858	EQUAL	2.559	3.465	0.625	65	88	16
24802-4607	EQUAL	6.750	8.750	0.875	171	222	22	24803-1901	EQUAL	2.250	3.189	0.625	57	81	16
24802-4653	EQUAL	1.188	2.358	0.625	30	60	16	24803-1915	EQUAL	1.625	2.375	0.625	41	60	16
24802-4660	EQUAL	2.047	2.953	0.625	52	75	16	24803-2001	EQUAL	2.000	3.125	0.625	51	79	16
24802-4685	EQUAL	1.469	2.375	0.625	37	60	16	24803-2037	EQUAL	2.750	3.500	0.500	70	89	13
24802-4696	EQUAL	3.777	4.732	0.625	96	120	16	24803-2280	EQUAL	3.250	4.250	0.625	83	108	16
24802-4697	EQUAL	3.934	5.120	0.625	100	130	16	24803-2368	EQUAL	3.500	4.500	0.625	89	114	16
24802-4743	EQUAL	4.438	5.890	0.625	113	150	16	24803-2593	EQUAL	4.000	5.000	0.625	102	127	16
24802-4935	EQUAL	1.496	2.441	0.625	38	62	16	24803-2662	EQUAL	2.500	3.543	0.625	64	90	16
24802-4943	EQUAL	1.890	2.835	0.625	48	72	16	24803-2755	EQUAL	4.500	5.500	0.625	114	140	16
24802-5047	EQUAL	3.188	4.249	0.625	81	108	16	24803-2931	EQUAL	4.750	5.750	0.625	121	146	16
24802-5069	EQUAL	2.875	4.375	0.625	73	111	16	24803-3011	EQUAL	1.688	3.313	0.625	43	84	16
24802-5095	EQUAL	2.756	3.622	0.625	70	92	16	24803-3222	EQUAL	3.373	4.373	0.625	86	111	16
24802-5096	EQUAL	2.000	3.500	0.625	51	89	16	24803-3669	EQUAL	5.250	6.375	0.625	133	162	16
24802-5110	EQUAL	3.346	5.118	0.625	85	130	16	24803-3764	EQUAL	3.500	5.000	0.625	89	127	16
24802-5309	EQUAL	4.133	5.511	0.625	105	140	16	24803-4866	EQUAL	2.500	3.547	0.625	64	90	16
24802-5368	EQUAL	2.125	3.875	0.625	54	98	16	24803-6040	EQUAL	5.375	6.875	0.625	137	175	16
24802-5369	EQUAL	2.125	4.000	0.625	54	102	16	24803-7642	EQUAL	3.375	4.250	0.500	86	108	13
24802-5371	EQUAL	1.125	2.043	0.625	29	52	16	24804-1349	EQUAL	5.906	7.087	0.625	150	180	16
24802-5382	EQUAL	3.544	4.565	0.625	90	116	16	24804-2260	EQUAL	1.378	2.165	0.625	35	55	16
24802-5434	EQUAL	1.187	2.437	0.625	30	62	16	24804-3022	EQUAL	5.118	6.299	0.625	130	160	16
24802-5448	EQUAL	1.654	4.193	0.625	42	107	16	24805-0792	EQUAL	1.875	2.875	0.625	48	73	16
24802-5449	EQUAL	3.562	4.625	0.625	90	117	16	24805-0989	EQUAL	1.875	2.625	0.625	48	67	16
24802-5461	EQUAL	3.500	4.875	0.625	89	124	16	24805-1026	EQUAL	1.750	2.500	0.625	44	64	16
24802-5490	EQUAL	2.375	3.365	0.625	60	85	16	24805-1138	EQUAL	1.375	2.835	0.625	35	72	16
24802-5494	EQUAL	1.725	2.625	0.625	44	67	16	24805-1144	EQUAL	3.938	4.938	0.625	100	125	16
24802-5510	EQUAL	4.646	5.906	0.625	118	150	16	24805-1194	EQUAL	1.500	2.500	0.625	38	64	16
24802-5573	EQUAL	1.125	2.437	0.625	29	62	16	24805-1214	EQUAL	1.500	2.375	0.625	38	60	16
24802-5593	EQUAL	0.984	1.969	0.625	25	50	16	24805-1350	EQUAL	2.000	3.000	0.625	51	76	16
24802-5604	EQUAL	3.937	5.512	0.625	100	140	16	24805-1744	EQUAL	1.750	2.750	0.625	44	70	16
24802-5606	EQUAL	2.165	3.744	0.625	55	95	16	24805-1761	EQUAL	2.125	3.125	0.625	54	79	16
24802-5625	EQUAL	7.087	8.465	0.625	180	215	16	24805-1818	EQUAL	2.500	3.500	0.625	64	89	16
24802-5650	EQUAL	3.346	4.331	0.625	85	110	16	24805-1915	EQUAL	1.625	2.375	0.625	41	60	16
24802-5780	EQUAL	5.704	7.210	0.625	145	183	16	24805-2959	EQUAL	1.180	2.370	0.625	30	60	16
24802-5781	EQUAL	6.804	8.310	0.625	173	211	16	24805-2960	EQUAL	1.967	2.955	0.625	50	75	16
24802-5917	EQUAL	1.378	2.441	0.625	35	62	16	24805-2983	EQUAL	2.125	3.100	0.625	54	79	16
24802-5936	EQUAL	2.248	3.228	0.625	57	82	16	24805-2987	EQUAL	1.625	2.500	0.625	41	64	16
24802-5986	EQUAL	3.535	5.625	0.625	90	143	16	24805-3029	EQUAL	1.563	2.500	0.625	40	64	16
24802-5988	EQUAL	4.125	5.625	0.625	105	143	16	24805-3097	EQUAL	0.594	1.375	0.625	15	35	16
24802-6005	EQUAL	1.813	2.875	0.625	46	73	16	24805-3805	EQUAL	1.570	2.500	0.625	40	64	16
24802-6010	EQUAL	8.750	10.625	0.625	222	270	16	24805-4536	EQUAL	1.625	2.502	0.625	41	64	16
24802-6193	EQUAL	3.150	4.016	0.625	80	102	16	24805-4537	EQUAL	1.575	2.441	0.625	40	62	16
24802-6505	EQUAL	2.813	4.000	0.625	71	102	16	24806-0988	EQUAL	1.125	2.000	0.625	29	51	16
24802-6768	EQUAL	3.937	4.687	0.625	100	119	16	24806-0998	EQUAL	1.750	2.875	0.625	44	73	16
24803-1001	EQUAL	1.625	2.375	0.500	41	60	13	24806-1101	EQUAL	1.375	2.375	0.625	35	60	16
24803-1008	EQUAL	1.375	2.250	0.500	35	57	13	24806-1754	EQUAL	1.000	1.875	0.625	25	48	16
24803-1011	EQUAL	2.125	3.189	0.500	54	81	13	24806-2023	EQUAL	1.767	2.800	0.625	45	71	16
24803-1026	EQUAL	1.750	2.500	0.625	44	64	16	24806-2220	EQUAL	1.875	2.625	0.688	48	67	17
24803-1046	EQUAL	3.188	4.254	0.500	81	108	13	24806-2419	EQUAL	3.625	4.625	0.625	92	117	16

All dimensions are in inches. Preferred sizes are indicated with **bold** type face.

Sizes listed are for standard nitrile elements, except Models 25 and 62 which have PTFE elements. Other material available on inquiry only.

## Oil Seals by Model Number

Product Code	Model	Inches			MM			Product Code	Model	Inches			MM		
		ID	OD	Width	ID	OD	Width			ID	OD	Width	ID	OD	Width
24806-2747	EQUAL	4.188	5.188	0.625	106	132	16	24807-2842	EQUAL	1.103	1.850	0.690	28	47	18
24806-3402	EQUAL	2.500	4.418	0.625	64	112	16	24807-2846	EQUAL	3.313	4.125	0.690	84	105	18
24806-4229	EQUAL	4.156	6.046	0.625	106	154	16	24807-2852	EQUAL	1.125	1.563	0.690	29	40	18
24806-4527	EQUAL	1.772	2.648	0.625	45	67	16	24807-2855	EQUAL	3.250	4.000	0.690	83	102	18
24806-6193	EQUAL	3.150	4.016	0.625	80	102	16	24807-2858	EQUAL	1.375	2.125	0.690	35	54	18
24807-1025	EQUAL	1.156	1.875	0.690	29	48	18	24807-2861	EQUAL	0.875	1.625	0.690	22	41	18
24807-1352	EQUAL	1.125	1.625	0.690	29	41	18	24807-2866	EQUAL	2.155	2.875	0.690	55	73	18
24807-1359	EQUAL	1.575	2.047	0.690	40	52	18	24807-2874	EQUAL	2.359	2.734	0.690	60	69	18
24807-1361	EQUAL	2.000	2.710	0.690	51	69	18	24807-2882	EQUAL	1.938	2.438	0.690	49	62	18
24807-1363	EQUAL	0.969	1.499	0.690	25	38	18	24807-2968	EQUAL	1.125	1.875	0.690	29	48	18
24807-1780	EQUAL	1.750	2.437	0.690	44	62	18	24807-2973	EQUAL	3.380	4.000	0.690	86	102	18
24807-1782	EQUAL	1.250	1.750	0.690	32	44	18	24807-2993	EQUAL	0.875	1.375	0.690	22	35	18
24807-1783	EQUAL	1.438	1.938	0.690	37	49	18	24807-2994	EQUAL	1.125	1.750	0.690	29	44	18
24807-1786	EQUAL	0.750	1.379	0.690	19	35	18	24807-2996	EQUAL	1.250	1.875	0.690	32	48	18
24807-1802	EQUAL	2.250	2.750	0.690	57	70	18	24807-3084	EQUAL	1.610	2.000	0.690	41	51	18
24807-1846	EQUAL	1.969	2.677	0.690	50	68	18	24807-3110	EQUAL	1.438	2.062	0.690	37	52	18
24807-1888	EQUAL	1.438	2.125	0.690	37	54	18	24807-3144	EQUAL	1.469	2.344	0.690	37	60	18
24807-1903	EQUAL	1.781	2.500	0.690	45	64	18	24807-3149	EQUAL	1.772	2.362	0.690	45	60	18
24807-1905	EQUAL	0.787	1.260	0.690	20	32	18	24807-3159	EQUAL	1.688	2.375	0.690	43	60	18
24807-1912	EQUAL	2.438	3.125	0.690	62	79	18	24807-3196	EQUAL	0.875	1.250	0.690	22	32	18
24807-1923	EQUAL	1.772	2.441	0.690	45	62	18	24807-3198	EQUAL	2.375	3.062	0.690	60	78	18
24807-1955	EQUAL	0.875	1.500	0.690	22	38	18	24807-3229	EQUAL	1.969	2.756	0.690	50	70	18
24807-1970	EQUAL	1.375	2.000	0.690	35	51	18	24807-3237	EQUAL	2.313	3.062	0.690	59	78	18
24807-2025	EQUAL	2.500	3.189	0.690	64	81	18	24807-3238	EQUAL	2.125	2.763	0.690	54	70	18
24807-2045	EQUAL	3.000	3.500	0.690	76	89	18	24807-3242	EQUAL	0.437	1.124	0.690	11	29	18
24807-2138	EQUAL	2.938	3.623	0.690	75	92	18	24807-3249	EQUAL	2.188	3.062	0.690	56	78	18
24807-2155	EQUAL	1.969	2.638	0.690	50	67	18	24807-3271	EQUAL	3.938	4.563	0.690	100	116	18
24807-2164	EQUAL	1.625	2.250	0.690	41	57	18	24807-3297	EQUAL	2.000	2.690	0.690	51	68	18
24807-2165	EQUAL	2.998	3.515	0.690	76	89	18	24807-3298	EQUAL	2.250	3.000	0.690	57	76	18
24807-2200	EQUAL	1.750	2.375	0.690	44	60	18	24807-3312	EQUAL	2.953	3.740	0.690	75	95	18
24807-2273	EQUAL	1.125	1.625	0.625	29	41	16	24807-3315	EQUAL	4.331	5.118	0.690	110	130	18
24807-2287	EQUAL	4.125	4.750	0.690	105	121	18	24807-3319	EQUAL	1.875	2.563	0.690	48	65	18
24807-2329	EQUAL	1.062	1.656	0.690	27	42	18	24807-3343	EQUAL	1.875	2.625	0.690	48	67	18
24807-2336	EQUAL	2.000	2.500	0.690	51	64	18	24807-3410	EQUAL	1.500	2.125	0.690	38	54	18
24807-2485	EQUAL	2.165	2.875	0.690	55	73	18	24807-3413	EQUAL	1.938	2.500	0.690	49	64	18
24807-2495	EQUAL	1.932	2.625	0.690	49	67	18	24807-3431	EQUAL	1.969	2.559	0.690	50	65	18
24807-2512	EQUAL	1.375	1.875	0.690	35	48	18	24807-3495	EQUAL	1.688	2.062	0.690	43	52	18
24807-2522	EQUAL	1.688	2.125	0.690	43	54	18	24807-3504	EQUAL	2.932	3.806	0.690	74	97	18
24807-2524	EQUAL	1.313	2.000	0.690	33	51	18	24807-3505	EQUAL	2.165	2.952	0.690	55	75	18
24807-2537	EQUAL	2.147	2.875	0.690	55	73	18	24807-3533	EQUAL	1.250	2.250	0.690	32	57	18
24807-2563	EQUAL	0.938	1.500	0.690	24	38	18	24807-3534	EQUAL	1.250	1.688	0.625	32	43	16
24807-2567	EQUAL	2.250	2.625	0.690	57	67	18	24807-3557	EQUAL	3.938	4.688	0.690	100	119	18
24807-2578	EQUAL	1.500	2.000	0.690	38	51	18	24807-3565	EQUAL	1.875	2.500	0.690	48	64	18
24807-2667	EQUAL	2.250	2.875	0.690	57	73	18	24807-3622	EQUAL	1.250	1.688	0.690	32	43	18
24807-2675	EQUAL	2.165	2.756	0.690	55	70	18	24807-3638	EQUAL	1.181	1.850	0.690	30	47	18
24807-2681	EQUAL	1.890	2.559	0.690	48	65	18	24807-3639	EQUAL	2.362	3.150	0.690	60	80	18
24807-2688	EQUAL	1.000	1.500	0.690	25	38	18	24807-3645	EQUAL	2.313	3.188	0.690	59	81	18
24807-2692	EQUAL	1.375	2.062	0.690	35	52	18	24807-3657	EQUAL	2.283	2.835	0.690	58	72	18
24807-2693	EQUAL	1.750	2.500	0.690	44	64	18	24807-3674	EQUAL	3.150	3.938	0.690	80	100	18
24807-2695	EQUAL	1.000	1.750	0.690	25	44	18	24807-3700	EQUAL	1.500	2.250	0.690	38	57	18
24807-2806	EQUAL	1.181	1.625	0.690	30	41	18	24807-3739	EQUAL	1.750	2.625	0.690	44	67	18
24807-2828	EQUAL	0.625	1.250	0.690	16	32	18	24807-3748	EQUAL	2.438	2.938	0.690	62	75	18
24807-2829	EQUAL	1.125	1.625	0.690	29	41	18	24807-3752	EQUAL	3.875	4.313	0.690	98	110	18
24807-2830	EQUAL	2.750	3.560	0.690	70	90	18	24807-3767	EQUAL	3.375	4.125	0.690	86	105	18
24807-2831	EQUAL	2.375	3.125	0.690	60	79	18	24807-3778	EQUAL	2.250	3.190	0.690	57	81	18
24807-2839	EQUAL	1.496	2.165	0.690	38	55	18	24807-3779	EQUAL	2.750	3.500	0.690	70	89	18

All dimensions are in inches. Preferred sizes are indicated with **bold** type face.  
 Sizes listed are for standard nitrile elements, except Models 25 and 62 which have PTFE elements. Other material available on inquiry only.



## Oil Seals by Model Number

Product Code	Model	Inches			MM			Product Code	Model	Inches			MM		
		ID	OD	Width	ID	OD	Width			ID	OD	Width	ID	OD	Width
24807-3781	EQUAL	3.750	4.750	0.690	95	121	18	24816-3982	EQUAL	1.438	2.063	0.875	37	52	22
24807-3782	EQUAL	4.500	5.500	0.690	114	140	18	24816-4446	EQUAL	1.750	2.776	0.750	44	71	19
24807-3784	EQUAL	1.720	2.250	0.690	44	57	18	24816-6161	EQUAL	7.938	9.340	1.229	202	237	31
24807-3831	EQUAL	2.622	3.046	0.690	67	77	18	24816-7004	EQUAL	2.438	3.192	1.062	62	81	27
24807-3835	EQUAL	2.622	3.346	0.690	67	85	18	24816-7005	EQUAL	3.062	3.810	1.062	78	97	27
24807-3877	EQUAL	1.125	1.801	0.690	29	46	18	24816-7006	EQUAL	4.188	5.243	1.375	106	133	35
24807-3878	EQUAL	2.145	2.865	0.690	54	73	18	24816-7007	EQUAL	4.875	5.983	1.375	124	152	35
24807-3907	EQUAL	1.063	1.625	0.690	27	41	18	24816-7014	EQUAL	6.062	7.349	1.375	154	187	35
24807-3912	EQUAL	1.875	2.375	0.690	48	60	18	24816-7015	EQUAL	7.000	8.375	1.375	178	213	35
24807-3952	EQUAL	1.750	2.250	0.690	44	57	18	24816-7017	EQUAL	2.938	3.956	1.375	75	100	35
24807-4076	EQUAL	4.724	5.315	0.472	120	135	12	24816-7018	EQUAL	3.938	4.984	1.375	100	127	35
24807-4078	EQUAL	1.375	1.750	0.690	35	44	18	24816-7019	EQUAL	1.938	2.567	0.875	49	65	22
24807-4079	EQUAL	1.625	2.125	0.690	41	54	18	24816-7020	EQUAL	2.188	2.825	1.125	56	72	29
24807-4132	EQUAL	2.530	3.287	0.690	64	83	18	24816-7021	EQUAL	2.688	3.574	1.062	68	91	27
24807-4200	EQUAL	2.205	2.837	0.690	56	72	18	24816-7022	EQUAL	2.938	3.817	1.062	75	97	27
24807-4359	EQUAL	1.625	2.125	0.813	41	54	21	24816-7023	EQUAL	3.000	3.818	1.375	76	97	35
24807-4378	EQUAL	1.375	1.750	0.813	35	44	21	24816-7024	EQUAL	4.125	5.025	1.375	105	128	35
24807-4471	EQUAL	4.003	4.500	0.690	102	114	18	24816-7025	EQUAL	3.438	4.458	1.313	87	113	33
24807-4523	EQUAL	3.750	4.375	0.690	95	111	18	24816-7026	EQUAL	3.938	4.957	1.375	100	126	35
24807-4652	EQUAL	4.938	5.500	0.690	125	140	18	24816-7027	EQUAL	4.188	5.230	1.375	106	133	35
24807-4677	EQUAL	2.000	2.716	0.690	51	69	18	24816-7028	EQUAL	4.438	5.548	1.375	113	141	35
24807-4713	EQUAL	2.047	2.750	0.690	52	70	18	24816-7029	EQUAL	4.938	5.982	1.375	125	152	35
24807-4851	EQUAL	2.000	2.670	0.690	51	68	18	24816-7030	EQUAL	5.000	5.982	1.375	127	152	35
24807-5104	EQUAL	3.346	3.937	0.690	85	100	18	24816-7031	EQUAL	3.938	5.328	1.375	100	135	35
24807-5379	EQUAL	0.984	1.750	0.690	25	44	18	24816-7032	EQUAL	2.813	3.569	1.375	71	91	35
24807-5590	EQUAL	2.188	2.837	0.690	56	72	18	24816-7033	EQUAL	3.438	4.338	1.375	87	110	35
24807-5752	EQUAL	0.984	1.496	0.690	25	38	18	24816-7035	EQUAL	2.500	3.192	1.062	64	81	27
24807-5796	EQUAL	1.062	1.500	0.690	27	38	18	24816-7036	EQUAL	3.500	4.458	1.313	89	113	33
24807-5797	EQUAL	1.156	2.000	0.690	29	51	18	24816-7039	EQUAL	6.625	8.390	1.375	168	213	35
24807-5809	EQUAL	2.500	3.000	0.690	64	76	18	24816-7040	EQUAL	6.000	7.340	1.375	152	186	35
24807-6134	EQUAL	2.375	3.000	0.690	60	76	18	24816-7041	EQUAL	1.938	2.563	0.875	49	65	22
24807-6424	EQUAL	1.625	2.375	0.690	41	60	18	24816-7042	EQUAL	2.750	3.772	1.000	70	96	25
24809-3020	EQUAL	1.500	2.813	0.625	38	71	16	24816-7043	EQUAL	6.438	7.780	1.375	164	198	35
24809-3151	EQUAL	1.690	2.813	0.625	43	71	16	24816-7044	EQUAL	3.813	4.773	1.375	97	121	35
24809-3510	EQUAL	1.965	2.965	0.625	50	75	16	24816-7047	EQUAL	3.938	5.643	1.125	100	143	29
24809-3989	EQUAL	2.756	4.331	0.625	70	110	16	24816-7048	EQUAL	3.938	4.955	1.252	100	126	32
24809-5616	EQUAL	1.750	2.620	0.625	44	67	16	24816-7049	EQUAL	5.438	6.750	1.250	138	171	32
24810-4433	EQUAL	1.575	2.677	0.625	40	68	16	24816-7050	EQUAL	3.250	4.335	1.313	83	110	33
24811-1090	EQUAL	0.875	1.750	0.625	22	44	16	24816-7052	EQUAL	8.938	10.443	1.563	227	265	40
24811-1166	EQUAL	1.500	2.625	0.625	38	67	16	24816-7054	EQUAL	6.625	7.719	1.250	168	196	32
24811-1765	EQUAL	0.875	2.000	0.625	22	51	16	24816-7055	EQUAL	5.750	6.938	1.250	146	176	32
24811-4419	EQUAL	1.125	2.750	0.625	29	70	16	24816-7058	EQUAL	2.362	3.366	0.750	60	85	19
24811-5206	EQUAL	1.575	3.543	0.625	40	90	16	24816-7060	EQUAL	2.938	4.480	1.063	75	114	27
24812-1090	EQUAL	0.875	1.750	0.625	22	44	16	24816-7063	EQUAL	1.772	2.539	0.748	45	64	19
24812-1214	EQUAL	1.500	2.375	0.625	38	60	16	24816-7065	EQUAL	2.165	2.972	0.748	55	75	19
24812-1405	EQUAL	0.750	1.499	0.625	19	38	16	24816-7067	EQUAL	1.438	2.063	0.975	37	52	25
24812-1754	EQUAL	1.000	1.875	0.625	25	48	16	24816-7068	EQUAL	6.000	7.343	1.375	152	187	35
24812-1932	EQUAL	1.250	2.125	0.625	32	54	16	24816-7111	EQUAL	7.437	8.945	1.375	189	227	35
24812-2092	EQUAL	1.965	2.875	0.625	50	73	16	24816-7118	EQUAL	5.875	6.938	1.523	149	176	39
24812-4829	EQUAL	1.259	2.165	0.625	32	55	16	24816-7119	EQUAL	3.188	4.335	1.298	81	110	33
24813-1479	EQUAL	2.250	3.000	0.625	57	76	16	24816-7124	EQUAL	1.438	2.063	0.778	37	52	20
24813-1818	EQUAL	2.500	3.500	0.625	64	89	16	24816-7131	EQUAL	3.188	4.335	1.312	81	110	33
24813-3543	EQUAL	2.953	3.953	0.625	75	100	16	24816-7132	EQUAL	7.188	8.570	0.928	183	218	24
24814-2688	EQUAL	1.000	1.500	0.690	25	38	18	24816-7138	EQUAL	3.438	4.460	1.375	87	113	35
24814-3196	EQUAL	0.875	1.250	0.690	22	32	18	24816-7145	EQUAL	5.938	7.343	1.144	151	187	29
24816-2564	EQUAL	2.438	3.188	1.125	62	81	29	24816-7147	EQUAL	3.437	4.523	1.312	87	115	33

All dimensions are in inches. Preferred sizes are indicated with **bold** type face. Sizes listed are for standard nitrile elements, except Models 25 and 62 which have PTFE elements. Other material available on inquiry only.

## Oil Seals by Model Number

Product Code	Model	Inches			MM			Product Code	Model	Inches			MM		
		ID	OD	Width	ID	OD	Width			ID	OD	Width	ID	OD	Width
24816-7170	EQUAL	7.062	8.375	1.375	179	213	35	24821-3170	EQUAL	2.560	3.560	0.625	65	90	16
24816-7189	EQUAL	3.938	5.640	0.808	100	143	21	24821-3180	EQUAL	6.693	7.875	0.625	170	200	16
24818-2651	EQUAL	2.362	3.346	0.630	60	85	16	24821-3305	EQUAL	11.417	13.780	1.181	290	350	30
24819-0988	EQUAL	1.125	2.000	0.625	29	51	16	24821-3377	EQUAL	6.125	7.125	0.625	156	181	16
24819-0991	EQUAL	2.500	3.250	0.625	64	83	16	24821-3417	EQUAL	2.559	3.559	0.500	65	90	13
24819-0998	EQUAL	1.750	2.875	0.625	44	73	16	24821-3418	EQUAL	6.125	7.625	0.625	156	194	16
24819-1062	EQUAL	1.750	2.625	0.625	44	67	16	24821-3552	EQUAL	7.500	9.000	0.625	191	229	16
24819-1092	EQUAL	1.375	2.125	0.625	35	54	16	24821-3592	EQUAL	8.000	9.000	0.625	203	229	16
24819-1116	EQUAL	1.437	2.250	0.625	36	57	16	24821-3669	EQUAL	5.250	6.375	0.625	133	162	16
24819-1119	EQUAL	2.188	3.000	0.625	56	76	16	24821-3832	EQUAL	8.875	10.125	0.625	225	257	16
24819-1138	EQUAL	1.375	2.835	0.625	35	72	16	24821-3913	EQUAL	6.299	7.480	0.625	160	190	16
24819-1180	EQUAL	2.250	3.188	0.625	57	81	16	24821-5147	EQUAL	2.913	3.937	0.625	74	100	16
24819-1322	EQUAL	2.125	2.875	0.625	54	73	16	24821-5639	EQUAL	7.250	9.056	0.625	184	230	16
24819-1323	EQUAL	2.125	3.000	0.625	54	76	16	24821-6010	EQUAL	8.750	10.625	0.625	222	270	16
24819-1581	EQUAL	2.375	3.250	0.625	60	83	16	24821-6066	EQUAL	6.804	8.304	0.750	173	211	19
24819-1641	EQUAL	2.438	3.438	0.625	62	87	16	24821-6067	EQUAL	5.704	7.204	0.750	145	183	19
24819-1739	EQUAL	3.149	3.942	0.625	80	100	16	24821-6270	EQUAL	5.711	7.000	0.625	145	178	16
24819-1744	EQUAL	1.750	2.750	0.625	44	70	16	24822-0988	EQUAL	1.125	2.001	0.625	29	51	16
24819-1763	EQUAL	1.500	2.250	0.625	38	57	16	24822-0989	EQUAL	1.875	2.625	0.625	48	67	16
24819-1883	EQUAL	2.559	3.543	0.625	65	90	16	24822-0991	EQUAL	2.500	3.250	0.625	64	83	16
24819-1901	EQUAL	2.250	3.189	0.625	57	81	16	24822-0998	EQUAL	1.750	2.875	0.625	44	73	16
24819-2223	EQUAL	3.125	4.125	0.625	79	105	16	24822-1024	EQUAL	6.000	7.500	0.625	152	191	16
24819-2296	EQUAL	3.313	4.125	0.625	84	105	16	24822-1080	EQUAL	3.625	4.375	0.625	92	111	16
24819-2605	EQUAL	4.125	5.250	0.625	105	133	16	24822-1138	EQUAL	1.375	2.835	0.625	35	72	16
24819-2700	EQUAL	4.313	5.500	0.625	110	140	16	24822-1177	EQUAL	5.625	6.625	0.625	143	168	16
24819-2962	EQUAL	3.938	5.000	0.625	100	127	16	24822-1265	EQUAL	3.000	3.750	0.625	76	95	16
24819-2963	EQUAL	4.437	5.750	0.625	113	146	16	24822-1581	EQUAL	2.375	3.250	0.625	60	83	16
24819-4535	EQUAL	0.984	2.000	0.625	25	51	16	24822-1596	EQUAL	1.969	3.125	0.500	50	79	13
24819-4608	EQUAL	0.591	1.750	0.625	15	44	16	24822-1764	EQUAL	6.250	7.125	0.625	159	181	16
24820-0765	EQUAL	1.125	2.000	0.500	29	51	13	24822-1854	EQUAL	2.125	3.250	0.625	54	83	16
24820-0892	EQUAL	2.375	3.875	0.500	60	98	13	24822-1908	EQUAL	2.938	3.688	0.625	75	94	16
24820-1821	EQUAL	2.500	3.500	0.500	64	89	13	24822-1980	EQUAL	2.937	3.750	0.625	75	95	16
24820-1897	EQUAL	1.438	2.375	0.500	37	60	13	24822-2223	EQUAL	3.125	4.125	0.625	79	105	16
24820-2483	EQUAL	3.750	5.000	0.625	95	127	16	24822-2368	EQUAL	3.500	4.500	0.625	89	114	16
24820-3178	EQUAL	5.500	6.500	0.625	140	165	16	24822-2464	EQUAL	3.750	4.750	0.625	95	121	16
24820-3669	EQUAL	5.250	6.375	0.625	133	162	16	24822-2605	EQUAL	4.125	5.250	0.625	105	133	16
24820-3671	EQUAL	6.750	8.750	0.625	171	222	16	24822-2633	EQUAL	4.000	5.375	0.625	102	137	16
24820-3734	EQUAL	0.984	1.860	0.625	25	47	16	24822-2646	EQUAL	4.187	5.250	0.625	106	133	16
24820-3954	EQUAL	6.500	8.000	0.690	165	203	18	24822-2659	EQUAL	4.250	5.250	0.625	108	133	16
24820-4037	EQUAL	1.938	2.875	0.500	49	73	13	24822-2679	EQUAL	2.355	3.355	0.625	60	85	16
24820-4089	EQUAL	1.428	2.375	0.500	36	60	13	24822-2741	EQUAL	3.188	4.188	0.625	81	106	16
24821-0015	EQUAL	8.625	10.125	0.625	219	257	16	24822-2774	EQUAL	5.688	6.688	0.625	144	170	16
24821-0140	EQUAL	12.000	13.500	0.625	305	343	16	24822-2786	EQUAL	6.250	7.250	0.625	159	184	16
24821-0702	EQUAL	8.000	9.000	0.500	203	229	13	24822-2929	EQUAL	5.000	6.500	0.625	127	165	16
24821-0798	EQUAL	1.250	2.000	0.500	32	51	13	24822-2951	EQUAL	2.357	3.357	0.625	60	85	16
24821-1177	EQUAL	5.625	6.625	0.625	143	168	16	24822-2978	EQUAL	7.750	8.750	0.750	197	222	19
24821-1596	EQUAL	1.969	3.125	0.500	50	79	13	24822-2979	EQUAL	7.188	8.640	0.750	183	219	19
24821-2058	EQUAL	2.750	3.750	0.438	70	95	11	24822-3073	EQUAL	5.250	6.750	0.625	133	171	16
24821-2270	EQUAL	5.250	6.250	0.625	133	159	16	24822-3170	EQUAL	2.560	3.560	0.625	65	90	16
24821-2462	EQUAL	3.750	4.750	0.500	95	121	13	24822-3178	EQUAL	5.500	6.500	0.625	140	165	16
24821-2600	EQUAL	4.125	5.125	0.500	105	130	13	24822-3184	EQUAL	5.500	6.750	0.625	140	171	16
24821-2604	EQUAL	4.125	5.125	0.625	105	130	16	24822-3236	EQUAL	5.625	6.875	0.625	143	175	16
24821-2753	EQUAL	4.500	5.500	0.500	114	140	13	24822-3277	EQUAL	5.750	6.750	0.625	146	171	16
24821-2915	EQUAL	5.000	6.000	0.625	127	152	16	24822-3324	EQUAL	5.875	7.125	0.625	149	181	16
24821-3068	EQUAL	8.465	9.965	0.750	215	253	19	24822-3357	EQUAL	6.000	7.000	0.625	152	178	16
24821-3070	EQUAL	7.087	8.587	0.750	180	218	19	24822-3426	EQUAL	6.500	7.500	0.625	165	191	16

All dimensions are in inches. Preferred sizes are indicated with **bold** type face.  
 Sizes listed are for standard nitrile elements, except Models 25 and 62 which have PTFE elements. Other material available on inquiry only.

## Oil Seals by Model Number

Product Code	Model	Inches			MM			Product Code	Model	Inches			MM		
		ID	OD	Width	ID	OD	Width			ID	OD	Width	ID	OD	Width
24822-3496	EQUAL	7.000	8.250	0.625	178	210	16	24824-3239	EQUAL	2.313	3.062	0.625	59	78	16
24822-3552	EQUAL	7.500	9.000	0.625	191	229	16	24824-3371	EQUAL	4.938	6.500	0.625	125	165	16
24822-3578	EQUAL	7.750	9.250	0.625	197	235	16	24824-3381	EQUAL	1.968	2.719	0.625	50	69	16
24822-3727	EQUAL	5.118	6.118	0.625	130	155	16	24824-3421	EQUAL	5.433	6.437	0.625	138	163	16
24822-3728	EQUAL	5.512	6.512	0.625	140	165	16	24824-3545	EQUAL	1.500	2.299	0.625	38	58	16
24822-3730	EQUAL	6.062	7.550	0.625	154	192	16	24824-3562	EQUAL	3.250	4.336	0.625	83	110	16
24822-3731	EQUAL	6.437	7.550	0.625	163	192	16	24824-3652	EQUAL	1.938	2.688	0.625	49	68	16
24822-3925	EQUAL	8.000	10.000	0.750	203	254	19	24824-5009	EQUAL	2.781	3.593	0.625	71	91	16
24822-4123	EQUAL	0.875	1.625	0.625	22	41	16	24825-1026	EQUAL	1.750	2.500	0.625	44	64	16
24822-4136	EQUAL	3.523	4.500	0.625	89	114	16	24827-2083	EQUAL	2.938	3.938	0.625	75	100	16
24822-4390	EQUAL	4.250	5.625	0.625	108	143	16	24829-0989	EQUAL	1.875	2.625	0.625	48	67	16
24822-4606	EQUAL	6.750	7.750	0.625	171	197	16	24829-1220	EQUAL	3.000	4.000	0.625	76	102	16
24822-4686	EQUAL	7.480	8.661	0.625	190	220	16	24829-1641	EQUAL	2.437	3.437	0.625	62	87	16
24822-4950	EQUAL	10.000	11.500	0.625	254	292	16	24829-1893	EQUAL	2.625	3.500	0.625	67	89	16
24822-5083	EQUAL	7.680	8.680	0.750	195	220	19	24829-2215	EQUAL	3.150	4.134	0.500	80	105	13
24822-5105	EQUAL	7.874	9.449	0.625	200	240	16	24829-2222	EQUAL	3.125	4.000	0.625	79	102	16
24822-5142	EQUAL	7.438	9.000	0.625	189	229	16	24829-2280	EQUAL	3.250	4.250	0.625	83	108	16
24822-5366	EQUAL	8.245	9.230	0.625	209	234	16	24829-2344	EQUAL	3.438	4.188	0.625	87	106	16
24822-5695	EQUAL	6.804	8.304	0.625	173	211	16	24829-2368	EQUAL	3.500	4.500	0.625	89	114	16
24822-5696	EQUAL	5.704	7.204	0.625	145	183	16	24829-2374	EQUAL	3.500	4.750	0.625	89	121	16
24822-6004	EQUAL	6.102	7.087	0.625	155	180	16	24829-2577	EQUAL	3.438	4.438	0.625	87	113	16
24823-1955	EQUAL	0.875	1.500	0.690	22	38	18	24829-2720	EQUAL	1.437	2.437	0.625	36	62	16
24823-3196	EQUAL	0.875	1.250	0.690	22	32	18	24829-2736	EQUAL	2.688	3.688	0.625	68	94	16
24823-4432	EQUAL	3.023	3.751	0.690	77	95	18	24829-2956	EQUAL	1.933	2.735	0.625	49	69	16
24823-4939	EQUAL	1.772	2.362	0.690	45	60	18	24829-2983	EQUAL	2.125	3.100	0.625	54	79	16
24823-5267	EQUAL	5.512	6.000	0.690	140	152	18	24829-3155	EQUAL	3.938	5.000	0.625	100	127	16
24824-0811	EQUAL	4.250	5.500	0.625	108	140	16	24829-3429	EQUAL	3.938	5.938	0.625	100	151	16
24824-1026	EQUAL	1.750	2.500	0.625	44	64	16	24829-3935	EQUAL	8.500	9.500	0.625	216	241	16
24824-1092	EQUAL	1.375	2.125	0.625	35	54	16	24829-4034	EQUAL	1.438	2.625	0.625	37	67	16
24824-1220	EQUAL	3.000	4.000	0.625	76	102	16	24829-5389	EQUAL	2.047	3.346	0.625	52	85	16
24824-1249	EQUAL	2.000	2.750	0.625	51	70	16	24829-5458	EQUAL	2.756	4.921	0.625	70	125	16
24824-1283	EQUAL	1.000	1.750	0.625	25	44	16	24830-3098	EQUAL	4.331	5.512	0.690	110	140	18
24824-1323	EQUAL	2.125	3.000	0.625	54	76	16	24831-0167	EQUAL	3.740	5.515	0.625	95	140	16
24824-1353	EQUAL	2.188	3.193	0.625	56	81	16	24831-0989	EQUAL	1.875	2.625	0.625	48	67	16
24824-1493	EQUAL	2.250	3.250	0.625	57	83	16	24831-3166	EQUAL	1.375	3.922	0.550	35	100	14
24824-1641	EQUAL	2.438	3.438	0.625	62	87	16	24831-3167	EQUAL	1.125	3.087	0.550	29	78	14
24824-1818	EQUAL	2.500	3.500	0.625	64	89	16	24831-5208	EQUAL	1.125	2.125	0.350	29	54	9
24824-1951	EQUAL	2.500	3.625	0.625	64	92	16	24831-5209	EQUAL	1.125	1.875	0.350	29	48	9
24824-2069	EQUAL	2.748	4.250	0.625	70	108	16	24831-5616	EQUAL	1.750	3.250	0.550	44	83	14
24824-2280	EQUAL	3.250	4.250	0.625	83	108	16	24832-0991	EQUAL	2.500	3.250	0.625	64	83	16
24824-2344	EQUAL	3.438	4.190	0.625	87	106	16	24832-1085	EQUAL	5.125	6.250	0.625	130	159	16
24824-2368	EQUAL	3.500	4.500	0.625	89	114	16	24832-1250	EQUAL	2.750	3.750	0.625	70	95	16
24824-2464	EQUAL	3.750	4.750	0.625	95	121	16	24833-1911	EQUAL	3.438	4.500	0.625	87	114	16
24824-2573	EQUAL	5.250	6.750	0.750	133	171	19	24833-2264	EQUAL	2.750	3.625	0.625	70	92	16
24824-2767	EQUAL	4.500	6.000	0.625	114	152	16	24834-2688	EQUAL	1.000	1.500	0.690	25	38	18
24824-2814	EQUAL	4.625	5.875	0.625	117	149	16	24835-0988	EQUAL	1.125	2.000	0.625	29	51	16
24824-2845	EQUAL	4.750	6.000	0.625	121	152	16	24835-1818	EQUAL	2.500	3.500	0.625	64	89	16
24824-2850	EQUAL	1.438	2.250	0.625	37	57	16	24835-2280	EQUAL	3.250	4.250	0.625	83	108	16
24824-2874	EQUAL	4.250	5.375	0.625	108	137	16	24836-3325	EQUAL	1.875	2.625	0.670	48	67	17
24824-2888	EQUAL	2.688	3.438	0.625	68	87	16	24836-3328	EQUAL	1.125	2.000	0.670	29	51	17
24824-2945	EQUAL	3.938	5.200	0.500	100	132	13	24838-3298	EQUAL	2.250	3.000	0.690	57	76	18
24824-3006	EQUAL	2.375	3.438	0.625	60	87	16	24839-7004	EQUAL	2.438	3.192	1.125	62	81	29
24824-3009	EQUAL	3.250	4.313	0.625	83	110	16	24839-7021	EQUAL	2.688	3.574	1.062	68	91	27
24824-3082	EQUAL	3.375	4.438	0.625	86	113	16	24839-7022	EQUAL	2.938	3.817	1.062	75	97	27
24824-3147	EQUAL	4.875	6.375	0.625	124	162	16	24839-7045	EQUAL	8.313	9.840	1.625	211	250	41
24824-3156	EQUAL	4.332	5.575	0.625	110	142	16	24839-7046	EQUAL	9.563	11.028	1.625	243	280	41

All dimensions are in inches. Preferred sizes are indicated with **bold** type face.

Sizes listed are for standard nitrile elements, except Models 25 and 62 which have PTFE elements. Other material available on inquiry only.

## Oil Seals by Model Number

Product Code	Model	Inches			MM			Product Code	Model	Inches			MM		
		ID	OD	Width	ID	OD	Width			ID	OD	Width	ID	OD	Width
24839-7131	EQUAL	3.188	4.335	1.312	81	110	33	29602-4112	GD	2.375	3.250	0.700	60	83	18
24840-3537	EQUAL	5.500	6.875	0.750	140	175	19	29602-4113	GD	3.313	4.125	0.700	84	105	18
24841-3606	EQUAL	8.250	9.500	0.625	210	241	16	29602-4114	GD	3.125	4.125	0.700	79	105	18
24842-4613	EQUAL	1.771	2.559	0.625	45	65	16	29602-4115	GD	4.312	5.500	0.700	110	140	18
24843-2917	EQUAL	5.000	6.000	0.625	127	152	16	29602-4116	GD	4.125	5.250	0.700	105	133	18
24843-3277	EQUAL	5.750	6.750	0.625	146	171	16	29602-4117	GD	1.438	2.250	0.700	37	57	18
24844-1641	EQUAL	2.437	3.437	0.625	62	87	16	29602-4118	GD	1.375	2.125	0.700	35	54	18
24847-2563	EQUAL	0.938	1.500	0.690	24	38	18	29602-4119	GD	2.062	3.000	0.700	52	76	18
24847-2833	EQUAL	2.000	2.750	0.690	51	70	18	29602-4120	GD	1.938	3.000	0.700	49	76	18
24847-3196	EQUAL	0.875	1.250	0.690	22	32	18	29602-4124	GD	1.875	2.625	0.700	48	67	18
24847-3907	EQUAL	1.063	1.625	0.690	27	41	18	29602-4125	GD	2.625	3.677	0.700	67	93	18
24847-5202	EQUAL	1.378	2.836	0.690	35	72	18	29602-4138	GD	1.000	2.000	0.700	25	51	18
24847-6079	EQUAL	1.378	3.228	0.690	35	82	18	29602-4139	GD	1.125	2.125	0.700	29	54	18
24847-6338	EQUAL	1.378	3.350	0.690	35	85	18	29602-4140	GD	1.250	2.250	0.700	32	57	18
24848-0989	EQUAL	1.875	2.625	0.625	48	67	16	29602-4141	GD	1.375	2.375	0.700	35	60	18
24848-3776	EQUAL	0.750	1.750	0.625	19	44	16	29602-4143	GD	1.500	2.500	0.700	38	64	18
24849-3976	EQUAL	1.180	2.056	0.625	30	52	16	29602-4144	GD	1.625	2.625	0.700	41	67	18
24850-1350	EQUAL	2.000	3.000	0.625	51	76	16	29602-4145	GD	1.750	2.750	0.700	44	70	18
24850-2107	EQUAL	1.437	2.500	0.625	36	64	16	29602-4146	GD	2.125	3.125	0.700	54	79	18
24850-3029	EQUAL	1.563	2.500	0.625	40	64	16	29602-4148	GD	2.250	3.250	0.700	57	83	18
24850-4690	EQUAL	2.438	3.625	0.625	62	92	16	29602-4149	GD	2.375	3.375	0.700	60	86	18
24850-4691	EQUAL	2.938	4.188	0.625	75	106	16	29602-4150	GD	2.500	3.500	0.700	64	89	18
24851-2107	EQUAL	1.438	2.500	0.625	37	64	16	29602-4151	GD	2.625	3.625	0.700	67	92	18
24852-4475	EQUAL	1.772	2.625	0.690	45	67	18	29602-4152	GD	2.750	3.750	0.700	70	95	18
24853-1754	EQUAL	1.000	1.875	0.625	25	48	16	29602-4153	GD	2.875	3.875	0.700	73	98	18
24854-2083	EQUAL	2.938	3.938	0.625	75	100	16	29602-4154	GD	3.250	4.250	0.700	83	108	18
24856-0765	EQUAL	1.125	2.000	0.500	29	51	13	29602-4156	GD	3.500	4.500	0.700	89	114	18
24857-1846	EQUAL	1.969	2.677	0.690	50	68	18	29602-4157	GD	3.625	4.625	0.700	92	117	18
29520-6574	EQUAL	5.500	6.750	0.750	140	171	19	29602-4158	GD	3.750	4.750	0.700	95	121	18
29602-0000	GD	1.125	2.000	0.700	29	51	18	29602-4159	GD	3.875	4.875	0.700	98	124	18
29602-0774	GD	3.375	4.375	0.700	86	111	18	29602-4160	GD	4.000	5.000	0.700	102	127	18
29602-1510	GD	2.812	3.750	0.700	71	95	18	29602-4161	GD	4.125	5.125	0.700	105	130	18
29602-1752	GD	1.378	2.362	0.700	35	60	18	29602-4163	GD	4.250	5.250	0.700	108	133	18
29602-1836	GD	3.000	4.062	0.700	76	103	18	29602-4164	GD	4.375	5.375	0.700	111	137	18
29602-2002	GD	0.984	2.362	0.700	25	60	18	29602-4165	GD	4.500	5.500	0.700	114	140	18
29602-2051	GD	4.563	5.563	0.700	116	141	18	29602-4167	GD	4.750	5.750	0.700	121	146	18
29602-2175	GD	3.000	4.000	0.700	76	102	18	29602-4168	GD	4.875	5.875	0.700	124	149	18
29602-2365	GD	3.523	4.523	0.700	89	115	18	29602-4169	GD	5.000	6.000	0.700	127	152	18
29602-2414	GD	3.250	4.003	0.700	83	102	18	29602-4173	GD	5.625	6.625	0.700	143	168	18
29602-2573	GD	5.250	6.750	0.700	133	171	18	29602-4177	GD	1.437	2.437	0.700	36	62	18
29602-3253	GD	3.149	4.173	0.700	80	106	18	29602-4181	GD	1.125	2.441	0.700	29	62	18
29602-3349	GD	2.000	3.000	0.700	51	76	18	29602-4182	GD	1.000	1.750	0.700	25	44	18
29602-3370	GD	6.000	7.500	0.700	152	191	18	29602-4185	GD	1.250	2.000	0.700	32	51	18
29602-3405	GD	6.250	7.750	0.700	159	197	18	29602-4186	GD	3.250	4.000	0.700	83	102	18
29602-3435	GD	6.500	8.000	0.700	165	203	18	29602-4187	GD	2.750	3.500	0.700	70	89	18
29602-3465	GD	6.750	8.250	0.700	171	210	18	29602-4189	GD	1.890	2.756	0.700	48	70	18
29602-3527	GD	7.250	8.750	0.700	184	222	18	29602-4190	GD	2.165	3.150	0.700	55	80	18
29602-3531	GD	7.250	8.500	0.700	184	216	18	29602-4191	GD	2.362	3.346	0.700	60	85	18
29602-3585	GD	1.875	2.875	0.700	48	73	18	29602-4192	GD	2.756	3.740	0.700	70	95	18
29602-3615	GD	9.000	10.000	0.700	229	254	18	29602-4193	GD	3.346	4.331	0.700	85	110	18
29602-4104	GD	1.375	2.835	0.700	35	72	18	29602-4203	GD	5.000	6.250	0.700	127	159	18
29602-4107	GD	1.750	2.875	0.700	44	73	18	29602-4204	GD	2.187	3.000	0.700	56	76	18
29602-4108	GD	1.125	2.000	0.700	29	51	18	29602-4205	GD	2.125	3.000	0.700	54	76	18
29602-4109	GD	2.125	2.875	0.700	54	73	18	29602-4208	GD	5.250	6.500	0.700	133	165	18
29602-4110	GD	1.875	2.750	0.700	48	70	18	29602-4212	GD	4.500	6.000	0.700	114	152	18
29602-4111	GD	2.500	3.250	0.700	64	83	18	29602-4214	GD	3.500	4.375	0.700	89	111	18

All dimensions are in inches. Preferred sizes are indicated with **bold** type face.  
 Sizes listed are for standard nitrile elements, except Models 25 and 62 which have PTFE elements. Other material available on inquiry only.

## Oil Seals by Model Number

Product Code	Model	Inches			MM			Product Code	Model	Inches			MM		
		ID	OD	Width	ID	OD	Width			ID	OD	Width	ID	OD	Width
29602-4257	GD	2.312	3.312	0.700	59	84	18	29602-4729	GD	1.875	5.000	0.700	48	127	18
29602-4267	GD	0.875	1.875	0.700	22	48	18	29602-4730	GD	1.375	3.625	0.700	35	92	18
29602-4275	GD	1.688	2.688	0.700	43	68	18	29602-4731	GD	0.875	2.750	0.700	22	70	18
29602-4277	GD	1.938	2.938	0.700	49	75	18	29602-4749	GD	2.953	3.938	0.700	75	100	18
29602-4278	GD	2.063	3.063	0.700	52	78	18	29602-4758	GD	3.543	4.724	0.700	90	120	18
29602-4279	GD	2.187	3.187	0.700	56	81	18	29602-4772	GD	2.554	3.554	0.700	65	90	18
29602-4280	GD	2.438	3.438	0.700	62	87	18	29602-4786	GD	2.166	3.189	0.700	55	81	18
29602-4283	GD	2.812	3.812	0.700	71	97	18	29602-4798	GD	3.150	3.937	0.700	80	100	18
29602-4284	GD	2.938	3.938	0.700	75	100	18	29602-4806	GD	2.375	3.500	0.700	60	89	18
29602-4286	GD	3.188	4.188	0.700	81	106	18	29602-4807	GD	2.125	3.250	0.700	54	83	18
29602-4287	GD	3.313	4.313	0.700	84	110	18	29602-4819	GD	1.969	2.756	0.700	50	70	18
29602-4289	GD	3.563	4.563	0.700	91	116	18	29602-4830	GD	5.625	6.875	0.700	143	175	18
29602-4290	GD	3.688	4.688	0.700	94	119	18	29602-4847	GD	2.432	3.432	0.700	62	87	18
29602-4291	GD	3.812	4.812	0.700	97	122	18	29602-4883	GD	2.360	3.360	0.700	60	85	18
29602-4292	GD	3.938	4.938	0.700	100	125	18	29602-4969	GD	2.756	3.543	0.700	70	90	18
29602-4293	GD	4.063	5.063	0.700	103	129	18	29602-4972	GD	2.835	3.937	0.700	72	100	18
29602-4295	GD	4.188	5.188	0.700	106	132	18	29602-4973	GD	3.071	3.937	0.700	78	100	18
29602-4296	GD	4.312	5.312	0.700	110	135	18	29602-4974	GD	3.150	4.331	0.700	80	110	18
29602-4312	GD	6.250	7.250	0.700	159	184	18	29602-4987	GD	4.724	5.906	0.700	120	150	18
29602-4315	GD	6.438	7.438	0.700	164	189	18	29602-4991	GD	5.118	6.299	0.700	130	160	18
29602-4319	GD	1.750	2.500	0.700	44	64	18	29602-5000	GD	6.693	7.874	0.700	170	200	18
29602-4322	GD	1.125	1.875	0.700	29	48	18	29602-5055	GD	3.142	4.142	0.700	80	105	18
29602-4323	GD	1.750	2.625	0.700	44	67	18	29602-5057	GD	3.731	4.731	0.700	95	120	18
29602-4324	GD	2.375	3.125	0.700	60	79	18	29602-5087	GD	3.335	4.335	0.700	85	110	18
29602-4326	GD	2.000	2.750	0.700	51	70	18	29602-5128	GD	3.938	5.250	0.700	100	133	18
29602-4327	GD	1.625	2.500	0.700	41	64	18	29602-5134	GD	2.250	4.812	0.700	57	122	18
29602-4328	GD	3.000	3.875	0.700	76	98	18	29602-5141	GD	3.150	4.150	0.700	80	105	18
29602-4329	GD	1.375	3.125	0.700	35	79	18	29602-5149	GD	1.180	2.000	0.700	30	51	18
29602-4330	GD	1.875	2.686	0.700	48	68	18	29602-5159	GD	4.724	5.724	0.700	120	145	18
29602-4331	GD	2.875	4.000	0.700	73	102	18	29602-5165	GD	3.563	4.500	0.700	91	114	18
29602-4332	GD	2.625	3.484	0.700	67	88	18	29602-5285	GD	6.000	6.750	0.700	152	171	18
29602-4335	GD	2.065	3.000	0.700	52	76	18	29602-5287	GD	6.750	7.750	0.700	171	197	18
29602-4338	GD	2.280	3.280	0.700	58	83	18	29602-5301	GD	1.371	2.371	0.700	35	60	18
29602-4348	GD	1.750	3.937	0.700	44	100	18	29602-5312	GD	2.875	4.250	0.700	73	108	18
29602-4350	GD	1.766	2.750	0.700	45	70	18	29602-5342	GD	2.165	3.165	0.700	55	80	18
29602-4351	GD	2.355	3.870	0.700	60	98	18	29602-5364	GD	3.750	5.000	0.700	95	127	18
29602-4353	GD	2.500	4.375	0.700	64	111	18	29602-5383	GD	4.331	5.331	0.700	110	135	18
29602-4356	GD	1.900	3.500	0.700	48	89	18	29602-5385	GD	5.187	7.000	0.700	132	178	18
29602-4367	GD	2.250	3.190	0.700	57	81	18	29602-5474	GD	8.000	9.000	0.700	203	229	18
29602-4379	GD	3.375	4.500	0.700	86	114	18	29602-5479	GD	3.543	4.543	0.700	90	115	18
29602-4386	GD	2.875	4.625	0.700	73	117	18	29602-5512	GD	2.362	3.362	0.700	60	85	18
29602-4391	GD	4.500	5.750	0.700	114	146	18	29602-5523	GD	1.764	2.764	0.700	45	70	18
29602-4425	GD	3.250	4.500	0.700	83	114	18	29602-5539	GD	1.575	2.362	0.700	40	60	18
29602-4438	GD	2.625	3.500	0.700	67	89	18	29602-5585	GD	2.375	3.130	0.700	60	80	18
29602-4462	GD	2.250	3.000	0.700	57	76	18	29602-5611	GD	2.770	3.770	0.700	70	96	18
29602-4472	GD	4.938	6.000	0.700	125	152	18	29602-5613	GD	4.318	5.318	0.700	110	135	18
29602-4479	GD	2.875	3.750	0.700	73	95	18	29602-5632	GD	1.969	2.992	0.700	50	76	18
29602-4506	GD	3.740	4.740	0.700	95	120	18	29602-5648	GD	3.925	4.925	0.700	100	125	18
29602-4548	GD	2.875	3.625	0.700	73	92	18	29602-5682	GD	3.526	4.526	0.700	90	115	18
29602-4550	GD	3.188	4.250	0.700	81	108	18	29602-5699	GD	4.375	5.500	0.700	111	140	18
29602-4576	GD	3.500	4.625	0.700	89	117	18	29602-5718	GD	2.550	3.550	0.700	65	90	18
29602-4630	GD	2.558	3.558	0.700	65	90	18	29602-5735	GD	4.325	5.325	0.700	110	135	18
29602-4650	GD	3.438	4.500	0.700	87	114	18	29602-5743	GD	1.500	2.750	0.700	38	70	18
29602-4704	GD	1.875	3.938	0.700	48	100	18	29602-5748	GD	3.540	4.540	0.700	90	115	18
29602-4709	GD	3.000	3.750	0.700	76	95	18	29602-5772	GD	2.625	3.750	0.700	67	95	18
29602-4721	GD	2.559	3.543	0.700	65	90	18	29602-5795	GD	2.559	3.583	0.700	65	91	18

All dimensions are in inches. Preferred sizes are indicated with **bold** type face.

Sizes listed are for standard nitrile elements, except Models 25 and 62 which have PTFE elements. Other material available on inquiry only.

## Oil Seals by Model Number

Product Code	Model	Inches			MM			Product Code	Model	Inches			MM		
		ID	OD	Width	ID	OD	Width			ID	OD	Width	ID	OD	Width
29602-5955	GD	9.842	10.593	0.700	250	269	18	29602-6700	GD	4.585	5.585	0.700	116	142	18
29602-5991	GD	6.000	7.125	0.700	152	181	18	29602-6701	GD	5.370	6.370	0.700	136	162	18
29602-5992	GD	7.500	8.750	0.700	191	222	18	29602-6706	GD	3.407	4.407	0.700	87	112	18
29602-6071	GD	3.000	4.250	0.700	76	108	18	29602-6707	GD	1.378	2.378	0.700	35	60	18
29602-6145	GD	3.000	4.003	0.700	76	102	18	29602-6713	GD	2.438	3.481	0.700	62	88	18
29602-6382	GD	2.558	3.561	0.700	65	90	18	29602-6722	GD	3.125	4.000	0.700	79	102	18
29602-6408	GD	3.500	4.750	0.700	89	121	18	29602-6723	GD	10.500	11.500	0.700	267	292	18
29602-6418	GD	3.938	4.688	0.700	100	119	18	29602-6727	GD	4.998	6.249	0.700	127	159	18
29602-6421	GD	1.375	2.960	0.700	35	75	18	29602-6728	GD	3.144	4.144	0.700	80	105	18
29602-6430	GD	3.776	4.777	0.700	96	121	18	29602-6735	GD	3.895	4.900	0.700	99	124	18
29602-6433	GD	2.000	4.000	0.700	51	102	18	29602-6736	GD	4.575	5.590	0.700	116	142	18
29602-6478	GD	5.244	6.244	0.700	133	159	18	29602-6740	GD	2.756	3.513	0.700	70	89	18
29602-6482	GD	5.625	7.125	0.700	143	181	18	29602-6741	GD	5.118	6.274	0.700	130	159	18
29602-6494	GD	4.350	5.350	0.700	110	136	18	29602-6742	GD	4.903	5.903	0.700	125	150	18
29602-6503	GD	1.373	2.125	0.700	35	54	18	29602-6743	GD	2.565	3.565	0.700	65	91	18
29602-6508	GD	4.700	5.700	0.700	119	145	18	29602-6746	GD	4.187	6.000	0.700	106	152	18
29602-6509	GD	3.800	4.800	0.700	97	122	18	29602-6753	GD	3.347	4.347	0.700	85	110	18
29602-6512	GD	2.063	3.250	0.700	52	83	18	29602-6755	GD	3.476	4.476	0.700	88	114	18
29602-6527	GD	5.118	7.087	0.700	130	180	18	29602-6756	GD	3.507	4.507	0.700	89	114	18
29602-6528	GD	2.438	3.500	0.700	62	89	18	29602-6760	GD	3.374	4.505	0.700	86	114	18
29602-6537	GD	4.562	5.625	0.700	116	143	18	29602-6761	GD	3.372	4.510	0.700	86	115	18
29602-6546	GD	2.362	3.543	0.700	60	90	18	29602-6765	GD	1.166	2.166	0.700	30	55	18
29602-6552	GD	2.559	3.580	0.700	65	91	18	29602-6766	GD	3.940	4.940	0.700	100	125	18
29602-6574	GD	5.500	6.750	0.700	140	171	18	29602-6767	GD	4.486	5.586	0.700	114	142	18
29602-6577	GD	3.379	4.379	0.700	86	111	18	29602-6775	GD	2.756	3.625	0.700	70	92	18
29602-6581	GD	2.441	3.465	0.700	62	88	18	29602-6776	GD	1.693	2.480	0.700	43	63	18
29602-6588	GD	2.365	3.125	0.700	60	79	18	29602-6787	GD	5.438	6.625	0.700	138	168	18
29602-6595	GD	2.358	3.465	0.700	60	88	18	29602-6791	GD	2.372	3.372	0.700	60	86	18
29602-6617	GD	2.315	3.346	0.700	59	85	18	29602-6793	GD	2.080	3.200	0.700	53	81	18
29602-6619	GD	4.622	5.812	0.700	117	148	18	29602-6794	GD	3.780	4.780	0.700	96	121	18
29602-6620	GD	4.624	5.937	0.700	117	151	18	29602-6801	GD	3.015	4.000	0.700	77	102	18
29602-6621	GD	3.375	4.525	0.700	86	115	18	29602-6802	GD	3.512	4.750	0.700	89	121	18
29602-6625	GD	4.130	5.130	0.700	105	130	18	29602-6804	GD	4.331	5.500	0.700	110	140	18
29602-6626	GD	3.418	4.418	0.700	87	112	18	29602-6807	GD	3.337	4.337	0.700	85	110	18
29602-6631	GD	4.320	5.320	0.700	110	135	18	29602-6809	GD	2.352	3.352	0.700	60	85	18
29602-6634	GD	4.998	6.429	0.700	127	163	18	29602-6810	GD	2.585	3.598	0.700	66	91	18
29602-6635	GD	2.489	3.239	0.700	63	82	18	29602-6811	GD	3.404	4.404	0.700	86	112	18
29602-6638	GD	2.622	3.622	0.700	67	92	18	29602-6812	GD	2.348	3.348	0.700	60	85	18
29602-6643	GD	5.000	6.800	0.700	127	173	18	29602-6813	GD	5.827	6.693	0.700	148	170	18
29602-6645	GD	3.000	4.625	0.700	76	117	18	29602-6815	GD	1.574	3.142	0.700	40	80	18
29602-6648	GD	1.575	2.559	0.700	40	65	18	29602-6821	GD	3.935	4.935	0.700	100	125	18
29602-6650	GD	2.356	3.356	0.700	60	85	18	29602-6823	GD	3.425	4.449	0.700	87	113	18
29602-6662	GD	1.575	2.598	0.700	40	66	18	29602-6826	GD	3.320	4.320	0.700	84	110	18
29602-6664	GD	2.953	3.976	0.700	75	101	18	29602-6833	GD	3.408	4.408	0.700	87	112	18
29602-6665	GD	3.740	4.764	0.700	95	121	18	29602-6834	GD	3.412	4.412	0.700	87	112	18
29602-6671	GD	4.120	5.120	0.700	105	130	18	29602-6845	GD	1.352	2.352	0.700	34	60	18
29602-6672	GD	2.995	4.000	0.700	76	102	18	29602-6849	GD	3.558	4.500	0.700	90	114	18
29602-6673	GD	4.481	5.481	0.700	114	139	18	29602-6854	GD	2.475	3.475	0.700	63	88	18
29602-6674	GD	4.140	5.140	0.700	105	131	18	29602-6868	GD	3.393	4.393	0.700	86	112	18
29602-6679	GD	4.150	5.150	0.700	105	131	18	29602-6870	GD	3.375	4.407	0.700	86	112	18
29602-6680	GD	2.998	3.998	0.700	76	102	18	29602-6874	GD	3.325	4.425	0.700	84	112	18
29602-6681	GD	3.850	4.850	0.700	98	123	18	29602-6875	GD	3.350	4.350	0.700	85	110	18
29602-6685	GD	3.940	4.955	0.700	100	126	18	29602-6881	GD	2.296	3.543	0.700	58	90	18
29602-6689	GD	4.185	5.185	0.700	106	132	18	29602-6885	GD	4.582	5.482	0.700	116	139	18
29602-6694	GD	4.483	5.483	0.700	114	139	18	29602-6895	GD	4.250	6.000	0.700	108	152	18
29602-6695	GD	4.882	5.882	0.700	124	149	18	29602-6897	GD	4.888	5.888	0.700	124	150	18

All dimensions are in inches. Preferred sizes are indicated with **bold** type face.  
 Sizes listed are for standard nitrile elements, except Models 25 and 62 which have PTFE elements. Other material available on inquiry only.

## Oil Seals by Model Number

Product Code	Model	Inches			MM			Product Code	Model	Inches			MM		
		ID	OD	Width	ID	OD	Width			ID	OD	Width	ID	OD	Width
29602-6901	GD	2.422	3.422	0.700	62	87	18	29602-7309	GD	2.596	3.596	0.700	66	91	18
29602-6904	GD	2.060	3.200	0.700	52	81	18	29602-7311	GD	4.521	5.521	0.700	115	140	18
29602-6905	GD	3.022	4.220	0.700	77	107	18	29602-7344	GD	4.875	5.625	0.700	124	143	18
29602-6906	GD	2.623	3.623	0.700	67	92	18	29602-7363	GD	4.188	5.250	0.700	106	133	18
29602-6911	GD	0.928	2.000	0.700	24	51	18	29602-7385	GD	2.747	3.782	0.700	70	96	18
29602-6917	GD	4.274	5.274	0.700	109	134	18	29602-7419	GD	4.339	5.339	0.700	110	136	18
29602-6918	GD	2.397	3.397	0.700	61	86	18	29602-7420	GD	4.475	5.475	0.700	114	139	18
29602-6930	GD	3.250	5.999	0.700	83	152	18	29602-7421	GD	2.750	3.510	0.700	70	89	18
29602-6931	GD	4.724	5.692	0.700	120	145	18	29602-7425	GD	3.558	4.750	0.700	90	121	18
29602-6932	GD	1.583	2.623	0.700	40	67	18	29602-7435	GD	3.150	4.409	0.700	80	112	18
29602-6933	GD	4.770	6.250	0.700	121	159	18	29602-7441	GD	3.440	4.520	0.700	87	115	18
29602-6937	GD	2.502	3.502	0.700	64	89	18	29602-7442	GD	3.830	4.920	0.700	97	125	18
29602-6938	GD	2.502	4.417	0.700	64	112	18	29602-7460	GD	4.175	5.175	0.700	106	131	18
29602-6941	GD	4.060	5.060	0.700	103	129	18	29602-7471	GD	4.550	5.550	0.700	116	141	18
29602-6944	GD	3.149	4.090	0.700	80	104	18	29602-7473	GD	3.383	4.383	0.700	86	111	18
29602-6947	GD	5.100	6.125	0.700	130	156	18	29602-7478	GD	3.372	4.372	0.700	86	111	18
29602-6948	GD	2.875	4.003	0.700	73	102	18	29602-7480	GD	2.500	4.250	0.700	64	108	18
29602-6949	GD	4.500	5.495	0.700	114	140	18	29602-7481	GD	3.935	4.928	0.700	100	125	18
29602-6951	GD	4.329	5.329	0.700	110	135	18	29602-7520	GD	4.875	6.125	0.700	124	156	18
29602-6953	GD	2.873	3.873	0.700	73	98	18	29602-9186	GD	3.500	5.000	0.700	89	127	18
29602-6954	GD	3.366	4.469	0.700	85	114	18	29602-9323	GD	6.500	8.500	0.700	165	216	18
29602-6955	GD	3.701	4.469	0.700	94	114	18	29604-2017	GD	8.750	10.250	0.700	222	260	18
29602-6956	GD	3.915	4.915	0.700	99	125	18	29604-3553	GD	7.500	9.000	0.700	191	229	18
29602-6959	GD	2.562	3.938	0.700	65	100	18	29604-4164	GD	4.375	5.375	0.700	111	137	18
29602-6960	GD	3.542	4.542	0.700	90	115	18	29604-6090	GD	3.500	5.125	0.700	89	130	18
29602-6961	GD	4.569	5.569	0.700	116	141	18	29604-6871	GD	7.750	9.247	0.700	197	235	18
29602-6962	GD	3.149	3.937	0.700	80	100	18	29604-7256	GD	1.969	3.150	0.700	50	80	18
29602-6964	GD	3.250	4.525	0.700	83	115	18	29604-7282	GD	7.625	8.625	0.700	194	219	18
29602-6966	GD	2.162	3.162	0.700	55	80	18	29606-4925	GD	1.378	1.969	0.625	35	50	16
29602-6967	GD	3.744	4.744	0.700	95	120	18	29606-4942	GD	1.890	2.441	0.625	48	62	16
29602-6968	GD	0.866	1.969	0.700	22	50	18	29606-5401	GD	1.750	2.437	0.625	44	62	16
29602-6969	GD	1.378	3.149	0.700	35	80	18	29606-6783	GD	1.188	1.687	0.625	30	43	16
29602-6973	GD	3.304	4.304	0.700	84	109	18	29606-7255	GD	1.969	2.559	0.625	50	65	16
29602-6974	GD	3.472	4.472	0.700	88	114	18	29606-7305	GD	1.250	1.752	0.625	32	45	16
29602-6986	GD	3.937	4.940	0.700	100	125	18	29606-7306	GD	1.625	2.248	0.625	41	57	16
29602-6991	GD	4.835	5.835	0.700	123	148	18	29607-1026	GD	1.750	2.500	0.625	44	64	16
29602-6992	GD	5.620	6.620	0.700	143	168	18	29607-1028	GD	3.250	4.000	0.625	83	102	16
29602-6993	GD	3.538	4.538	0.700	90	115	18	29607-1118	GD	1.500	2.125	0.625	38	54	16
29602-6994	GD	3.339	4.339	0.700	85	110	18	29607-1146	GD	1.313	2.000	0.625	33	51	16
29602-6997	GD	3.250	6.020	0.700	83	153	18	29607-1238	GD	2.750	3.500	0.625	70	89	16
29602-6998	GD	2.430	3.430	0.700	62	87	18	29607-1249	GD	2.000	2.750	0.625	51	70	16
29602-6999	GD	2.437	4.019	0.700	62	102	18	29607-1581	GD	2.375	3.250	0.625	60	83	16
29602-7224	GD	5.667	6.667	0.700	144	169	18	29607-1744	GD	1.750	2.750	0.625	44	70	16
29602-7225	GD	4.877	5.877	0.700	124	149	18	29607-1766	GD	2.313	3.250	0.625	59	83	16
29602-7247	GD	1.937	2.734	0.700	49	69	18	29607-1976	GD	2.625	3.250	0.625	67	83	16
29602-7248	GD	2.562	3.312	0.700	65	84	18	29607-2005	GD	2.165	3.150	0.625	55	80	16
29602-7249	GD	3.560	4.310	0.700	90	109	18	29607-2273	GD	1.125	1.625	0.625	29	41	16
29602-7254	GD	3.730	4.730	0.700	95	120	18	29607-2464	GD	3.750	4.750	0.625	95	121	16
29602-7256	GD	1.969	3.150	0.700	50	80	18	29607-2917	GD	5.000	6.000	0.625	127	152	16
29602-7257	GD	4.257	5.250	0.700	108	133	18	29607-3534	GD	1.250	1.687	0.625	32	43	16
29602-7283	GD	2.436	3.438	0.700	62	87	18	29607-4106	GD	0.875	1.250	0.625	22	32	16
29602-7287	GD	2.952	3.952	0.700	75	100	18	29607-4123	GD	0.875	1.625	0.625	22	41	16
29602-7290	GD	1.675	2.558	0.700	43	65	18	29607-4130	GD	1.500	2.000	0.625	38	51	16
29602-7297	GD	1.750	2.693	0.700	44	68	18	29607-4176	GD	1.375	1.875	0.625	35	48	16
29602-7300	GD	3.150	3.937	0.700	80	100	18	29607-4183	GD	1.750	2.375	0.625	44	60	16
29602-7304	GD	3.425	4.500	0.700	87	114	18	29607-4184	GD	1.125	1.750	0.625	29	44	16

All dimensions are in inches. Preferred sizes are indicated with **bold** type face. Sizes listed are for standard nitrile elements, except Models 25 and 62 which have PTFE elements. Other material available on inquiry only.

## Oil Seals by Model Number

Product Code	Model	Inches			MM			Product Code	Model	Inches			MM		
		ID	OD	Width	ID	OD	Width			ID	OD	Width	ID	OD	Width
29607-4206	GD	1.062	1.643	0.625	27	42	16	29609-6737	GD	0.750	1.567	0.375	19	40	10
29607-4337	GD	2.155	2.875	0.625	55	73	16	29609-6745	GD	1.496	2.165	0.375	38	55	10
29607-4340	GD	1.250	1.750	0.625	32	44	16	29609-6818	GD	3.750	5.000	0.375	95	127	10
29607-4456	GD	1.438	2.125	0.625	37	54	16	29609-6889	GD	2.559	3.346	0.375	65	85	10
29607-4536	GD	1.625	2.502	0.625	41	64	16	29609-6890	GD	2.205	2.835	0.375	56	72	10
29607-4537	GD	1.575	2.441	0.625	40	62	16	29609-6892	GD	1.250	2.500	0.375	32	64	10
29607-4539	GD	2.000	2.625	0.625	51	67	16	29609-6899	GD	2.062	3.625	0.375	52	92	10
29607-4934	GD	1.496	2.165	0.625	38	55	16	29609-6900	GD	4.500	6.750	0.375	114	171	10
29607-4939	GD	1.772	2.362	0.625	45	60	16	29609-6926	GD	2.500	3.625	0.375	64	92	10
29607-4940	GD	1.772	2.441	0.625	45	62	16	29609-6952	GD	2.360	3.740	0.375	60	95	10
29607-5290	GD	1.625	2.250	0.625	41	57	16	29609-6957	GD	3.625	4.376	0.375	92	111	10
29607-5394	GD	1.125	1.875	0.625	29	48	16	29609-6972	GD	1.575	2.283	0.375	40	58	10
29607-5401	GD	1.750	2.437	0.625	44	62	16	29609-7240	GD	1.970	2.715	0.375	50	69	10
29607-5677	GD	3.375	4.000	0.625	86	102	16	29609-7250	GD	4.938	6.250	0.375	125	159	10
29607-6502	GD	1.498	2.125	0.625	38	54	16	29609-7299	GD	1.750	2.693	0.375	44	68	10
29607-6616	GD	1.625	2.080	0.625	41	53	16	29609-7522	GD	1.772	2.756	0.375	45	70	10
29607-6639	GD	3.937	4.627	0.625	100	118	16	29610-4108	GD	1.125	2.000	0.700	29	51	18
29607-6640	GD	4.410	5.000	0.625	112	127	16	29610-4109	GD	2.125	2.875	0.700	54	73	18
29607-6641	GD	4.568	5.000	0.625	116	127	16	29610-4153	GD	2.875	3.875	0.700	73	98	18
29607-6696	GD	2.933	3.498	0.625	74	89	16	29611-6853	GD	1.570	3.150	0.375	40	80	10
29607-6702	GD	3.346	4.331	0.625	85	110	16	29612-0998	GD	1.750	2.875	0.625	44	73	16
29607-6703	GD	3.688	4.125	0.625	94	105	16	29612-3366	GD	2.250	3.625	0.625	57	92	16
29607-6704	GD	3.188	3.625	0.625	81	92	16	29616-5432	GD	1.438	2.063	1.175	37	52	30
29607-6729	GD	3.937	4.615	0.625	100	117	16	29616-6945	GD	2.188	3.840	0.959	56	98	24
29607-6846	GD	1.970	2.360	0.625	50	60	16	29616-7072	GD	5.313	6.375	1.297	135	162	33
29607-6936	GD	4.425	5.125	0.625	112	130	16	29616-7073	GD	6.250	7.343	1.297	159	187	33
29607-6958	GD	1.496	2.265	0.625	38	58	16	29616-7082	GD	2.438	3.188	1.265	62	81	32
29607-7241	GD	1.925	2.500	0.625	49	64	16	29616-7088	GD	4.188	5.230	1.297	106	133	33
29607-7246	GD	1.250	1.985	0.625	32	50	16	29616-7092	GD	1.938	2.563	1.173	49	65	30
29607-7255	GD	1.969	2.559	0.625	50	65	16	29616-7093	GD	2.188	2.823	1.173	56	72	30
29607-7289	GD	1.675	2.360	0.625	43	60	16	29616-7094	GD	2.688	3.563	1.265	68	91	32
29607-7482	GD	2.435	3.434	0.625	62	87	16	29616-7095	GD	2.938	3.813	1.265	75	97	32
29608-2005	GD	2.165	3.150	0.625	55	80	16	29616-7098	GD	3.938	4.960	1.297	100	126	33
29608-6702	GD	3.346	4.331	0.625	85	110	16	29616-7099	GD	4.438	5.543	1.297	113	141	33
29608-6769	GD	3.460	4.331	0.625	88	110	16	29616-7103	GD	5.438	6.750	1.308	138	171	33
29608-6824	GD	3.560	4.125	0.625	90	105	16	29616-7112	GD	3.438	4.460	1.297	87	113	33
29609-0760	GD	1.625	2.375	0.375	41	60	10	29616-7117	GD	3.973	6.201	0.994	101	158	25
29609-0789	GD	1.575	2.500	0.375	40	64	10	29616-7129	GD	1.688	2.313	1.173	43	59	30
29609-0814	GD	1.125	2.062	0.375	29	52	10	29616-7137	GD	4.125	5.230	1.297	105	133	33
29609-0838	GD	2.375	3.500	0.375	60	89	10	29616-7139	GD	2.438	3.760	0.994	62	96	25
29609-1273	GD	0.750	1.625	0.375	19	41	10	29616-7196	GD	7.938	9.340	1.164	202	237	30
29609-1362	GD	2.165	2.835	0.375	55	72	10	29619-0811	GD	4.250	5.500	0.625	108	140	16
29609-1474	GD	2.250	3.000	0.375	57	76	10	29619-0991	GD	2.500	3.250	0.625	64	83	16
29609-1828	GD	2.500	3.750	0.375	64	95	10	29619-1083	GD	1.000	2.000	0.625	25	51	16
29609-1829	GD	1.375	2.125	0.375	35	54	10	29619-1089	GD	1.625	2.625	0.625	41	67	16
29609-1916	GD	2.625	3.625	0.375	67	92	10	29619-1101	GD	1.375	2.375	0.625	35	60	16
29609-2035	GD	2.750	3.500	0.375	70	89	10	29619-1220	GD	3.000	4.000	0.625	76	102	16
29609-2687	GD	3.750	4.750	0.375	95	121	10	29619-1242	GD	2.750	3.543	0.625	70	90	16
29609-3977	GD	1.875	2.750	0.375	48	70	10	29619-1252	GD	2.500	3.623	0.625	64	92	16
29609-3988	GD	2.500	4.003	0.375	64	102	10	29619-1581	GD	2.375	3.250	0.625	60	83	16
29609-4212	GD	4.500	6.000	0.375	114	152	10	29619-1818	GD	2.500	3.500	0.625	64	89	16
29609-4391	GD	4.500	5.750	0.375	114	146	10	29619-1894	GD	4.000	5.750	0.625	102	146	16
29609-5015	GD	2.441	3.937	0.374	62	100	10	29619-2116	GD	5.512	6.693	0.625	140	170	16
29609-5023	GD	3.000	4.000	0.375	76	102	10	29619-2210	GD	3.750	4.500	0.625	95	114	16
29609-6244	GD	2.938	4.125	0.375	75	105	10	29619-2223	GD	3.125	4.125	0.625	79	105	16
29609-6717	GD	2.559	4.724	0.375	65	120	10	29619-2296	GD	3.313	4.125	0.625	84	105	16

All dimensions are in inches. Preferred sizes are indicated with **bold** type face. Sizes listed are for standard nitrile elements, except Models 25 and 62 which have PTFE elements. Other material available on inquiry only.



## Oil Seals by Model Number

Product Code	Model	Inches			MM			Product Code	Model	Inches			MM		
		ID	OD	Width	ID	OD	Width			ID	OD	Width	ID	OD	Width
29619-2605	GD	4.125	5.250	0.625	105	133	16	29697-0005	GD	2.125	3.000	0.900	54	76	23
29619-2700	GD	4.313	5.500	0.625	110	140	16	29697-0006	GD	1.256	2.062	0.900	32	52	23
29619-2747	GD	4.188	5.188	0.625	106	132	16	29699-0001	GD	2.438	7.875	0.700	62	200	18
29619-2816	GD	2.559	3.346	0.626	65	85	16	29699-0002	GD	12.000	16.875	2.300	305	429	58
29619-3022	GD	5.118	6.299	0.625	130	160	16	29699-0003	GD	4.134	5.250	0.700	105	133	18
29619-3357	GD	6.000	7.000	0.625	152	178	16	29699-0004	GD	2.375	3.600	1.222	60	91	31
29619-3528	GD	7.375	8.375	0.625	187	213	16	29699-0005	GD	6.693	7.717	0.700	170	196	18
29619-3870	GD	2.441	3.937	0.626	62	100	16	29699-0006	GD	7.087	8.110	0.700	180	206	18
29619-4312	GD	6.250	7.250	0.625	159	184	16	29699-0007	GD	1.000	2.000	0.375	25	51	10
29619-4709	GD	3.000	3.750	0.625	76	95	16	29699-0008	GD	1.750	2.750	0.375	44	70	10
29619-4991	GD	5.118	6.299	0.625	130	160	16	29699-0010	GD	5.125	6.000	0.888	130	152	23
29619-6145	GD	3.000	4.003	0.625	76	102	16	29699-0015	GD	1.000	1.828	0.700	25	46	18
29619-6603	GD	1.575	2.517	0.625	40	64	16	29699-0016	GD	1.625	2.375	0.375	41	60	10
29619-6604	GD	4.148	5.349	0.625	105	136	16	29699-0018	GD	1.063	2.165	0.900	27	55	23
29619-6609	GD	3.483	4.506	0.625	88	114	16	29699-0021	GD	6.929	8.500	0.700	176	216	18
29619-6649	GD	1.575	2.559	0.625	40	65	16	29699-0023	GD	11.500	13.000	0.700	292	330	18
29619-6763	GD	8.858	10.039	0.625	225	255	16	29699-0024	GD	6.339	7.120	2.303	161	181	58
29619-6764	GD	9.842	11.023	0.625	250	280	16	29500-1257	IG	2.318	3.125	0.750	59	79	19
29619-6857	GD	2.950	3.970	0.625	75	101	16	29500-2017	IG	8.750	10.250	0.750	222	260	19
29619-6861	GD	2.161	3.347	0.625	55	85	16	29500-2175	IG	3.000	4.000	0.750	76	102	19
29619-6862	GD	5.117	6.438	0.625	130	164	16	29500-3349	IG	2.000	3.000	0.750	51	76	19
29619-6866	GD	2.360	3.740	0.625	60	95	16	29500-3370	IG	6.000	7.500	0.750	152	191	19
29619-6882	GD	2.296	3.543	0.625	58	90	16	29500-3465	IG	6.750	8.250	0.750	171	210	19
29619-6939	GD	3.813	5.513	0.625	97	140	16	29500-3467	IG	6.750	8.000	0.750	171	203	19
29619-6940	GD	4.625	6.538	0.625	117	166	16	29500-3501	IG	7.000	8.500	0.750	178	216	19
29619-6950	GD	4.500	5.495	0.625	114	140	16	29500-3553	IG	7.500	9.000	0.750	191	229	19
29619-6995	GD	1.150	2.000	0.625	29	51	16	29500-3585	IG	1.875	2.875	0.750	48	73	19
29619-6996	GD	1.875	2.625	0.625	48	67	16	29500-3589	IG	7.875	9.375	0.750	200	238	19
29619-7224	GD	5.667	6.667	0.625	144	169	16	29500-4104	IG	1.375	2.835	0.750	35	72	19
29619-7243	GD	3.750	5.754	0.625	95	146	16	29500-4107	IG	1.750	2.875	0.750	44	73	19
29619-7253	GD	3.858	4.921	0.625	98	125	16	29500-4108	IG	1.125	2.000	0.750	29	51	19
29619-7259	GD	3.655	4.405	0.625	93	112	16	29500-4109	IG	2.125	2.875	0.750	54	73	19
29619-7308	GD	6.625	8.000	0.625	168	203	16	29500-4110	IG	1.875	2.750	0.750	48	70	19
29619-7324	GD	7.000	8.268	0.625	178	210	16	29500-4111	IG	2.500	3.250	0.750	64	83	19
29619-7334	GD	7.874	9.055	0.625	200	230	16	29500-4112	IG	2.375	3.250	0.750	60	83	19
29619-7390	GD	1.750	2.750	0.625	44	70	16	29500-4113	IG	3.313	4.125	0.750	84	105	19
29619-7391	GD	1.125	2.000	0.625	29	51	16	29500-4114	IG	3.125	4.125	0.750	79	105	19
29620-1510	GD	2.812	3.750	0.700	71	95	18	29500-4115	IG	4.313	5.500	0.750	110	140	19
29620-3585	GD	1.875	2.875	0.700	48	73	18	29500-4116	IG	4.125	5.250	0.750	105	133	19
29620-4120	GD	1.938	3.000	0.700	49	76	18	29500-4118	IG	1.375	2.125	0.750	35	54	19
29620-4217	GD	2.000	3.125	0.700	51	79	18	29500-4120	IG	1.937	3.000	0.750	49	76	19
29620-4328	GD	3.000	3.875	0.700	76	98	18	29500-4124	IG	1.875	2.625	0.750	48	67	19
29620-4550	GD	3.188	4.250	0.700	81	108	18	29500-4140	IG	1.250	2.250	0.750	32	57	19
29620-4991	GD	5.118	6.299	0.700	130	160	18	29500-4141	IG	1.375	2.375	0.750	35	60	19
29620-5000	GD	6.693	7.874	0.700	170	200	18	29500-4143	IG	1.500	2.500	0.750	38	64	19
29620-6600	GD	7.087	8.661	0.700	180	220	18	29500-4144	IG	1.625	2.625	0.750	41	67	19
29620-6642	GD	7.255	8.997	0.700	184	229	18	29500-4145	IG	1.750	2.750	0.750	44	70	19
29620-6732	GD	2.688	3.500	0.700	68	89	18	29500-4146	IG	2.125	3.125	0.750	54	79	19
29620-6856	GD	1.625	3.000	0.700	41	76	18	29500-4148	IG	2.250	3.250	0.750	57	83	19
29620-6902	GD	8.750	9.750	0.700	222	248	18	29500-4149	IG	2.375	3.375	0.750	60	86	19
29620-7280	GD	3.400	4.200	0.700	86	107	18	29500-4150	IG	2.500	3.500	0.750	64	89	19
29620-7296	GD	4.343	5.110	0.700	110	130	18	29500-4151	IG	2.625	3.625	0.750	67	92	19
29620-7474	GD	3.900	5.000	0.700	99	127	18	29500-4152	IG	2.750	3.750	0.750	70	95	19
29621-2684	GD	1.000	1.500	0.625	25	38	16	29500-4154	IG	3.250	4.250	0.750	83	108	19
29621-6785	GD	2.437	3.375	0.625	62	86	16	29500-4156	IG	3.500	4.500	0.750	89	114	19
29621-7252	GD	1.969	2.345	0.625	50	60	16	29500-4158	IG	3.750	4.750	0.750	95	121	19

All dimensions are in inches. Preferred sizes are indicated with **bold** type face.

Sizes listed are for standard nitrile elements, except Models 25 and 62 which have PTFE elements. Other material available on inquiry only.

## Oil Seals by Model Number

Product Code	Model	Inches			MM			Product Code	Model	Inches			MM		
		ID	OD	Width	ID	OD	Width			ID	OD	Width	ID	OD	Width
29500-4160	IG	4.000	5.000	0.750	102	127	19	29500-4678	IG	1.771	3.938	0.750	45	100	19
29500-4161	IG	4.125	5.125	0.750	105	130	19	29500-4683	IG	2.500	3.543	0.750	64	90	19
29500-4163	IG	4.250	5.250	0.750	108	133	19	29500-4694	IG	2.875	4.134	0.750	73	105	19
29500-4164	IG	4.375	5.375	0.750	111	137	19	29500-4704	IG	1.875	3.938	0.750	48	100	19
29500-4167	IG	4.750	5.750	0.750	121	146	19	29500-4709	IG	3.000	3.750	0.750	76	95	19
29500-4173	IG	5.625	6.625	0.750	143	168	19	29500-4721	IG	2.559	3.543	0.750	65	90	19
29500-4174	IG	5.750	6.750	0.750	146	171	19	29500-4727	IG	2.375	3.544	0.750	60	90	19
29500-4181	IG	1.125	2.441	0.750	29	62	19	29500-4744	IG	2.165	3.542	0.750	55	90	19
29500-4187	IG	2.750	3.500	0.750	70	89	19	29500-4747	IG	2.520	3.740	0.750	64	95	19
29500-4192	IG	2.756	3.740	0.750	70	95	19	29500-4748	IG	3.386	5.118	0.750	86	130	19
29500-4193	IG	3.345	4.331	0.750	85	110	19	29500-4750	IG	3.386	5.315	0.750	86	135	19
29500-4203	IG	5.000	6.250	0.750	127	159	19	29500-4751	IG	3.740	5.512	0.750	95	140	19
29500-4212	IG	4.500	6.000	0.750	114	152	19	29500-4756	IG	7.480	8.661	0.750	190	220	19
29500-4214	IG	3.500	4.375	0.750	89	111	19	29500-4758	IG	3.543	4.724	0.750	90	120	19
29500-4280	IG	2.438	3.438	0.750	62	87	19	29500-4798	IG	3.150	3.937	0.750	80	100	19
29500-4281	IG	2.562	3.562	0.750	65	90	19	29500-4806	IG	2.375	3.500	0.750	60	89	19
29500-4284	IG	2.938	3.938	0.750	75	100	19	29500-4809	IG	1.875	3.000	0.750	48	76	19
29500-4292	IG	3.938	4.938	0.750	100	125	19	29500-4816	IG	3.346	4.921	0.750	85	125	19
29500-4310	IG	6.125	7.125	0.750	156	181	19	29500-4820	IG	1.000	2.441	0.750	25	62	19
29500-4312	IG	6.250	7.250	0.750	159	184	19	29500-4822	IG	2.953	3.740	0.750	75	95	19
29500-4315	IG	6.438	7.438	0.750	164	189	19	29500-4830	IG	5.625	6.875	0.750	143	175	19
29500-4319	IG	1.750	2.500	0.750	44	64	19	29500-4831	IG	5.906	6.906	0.750	150	175	19
29500-4331	IG	2.875	4.000	0.750	73	102	19	29500-4834	IG	2.812	4.002	0.750	71	102	19
29500-4361	IG	3.000	4.125	0.750	76	105	19	29500-4841	IG	4.449	6.378	0.750	113	162	19
29500-4374	IG	2.500	3.750	0.750	64	95	19	29500-4842	IG	4.429	6.297	0.750	112	160	19
29500-4379	IG	3.375	4.500	0.750	86	114	19	29500-4844	IG	3.543	4.960	0.750	90	126	19
29500-4391	IG	4.500	5.750	0.750	114	146	19	29500-4845	IG	3.938	5.188	0.750	100	132	19
29500-4425	IG	3.250	4.500	0.750	83	114	19	29500-4861	IG	2.312	3.812	0.750	59	97	19
29500-4438	IG	2.625	3.500	0.750	67	89	19	29500-4865	IG	6.250	7.500	0.750	159	191	19
29500-4462	IG	2.250	3.000	0.750	57	76	19	29500-4874	IG	2.250	3.625	0.750	57	92	19
29500-4464	IG	4.284	5.284	0.750	109	134	19	29500-4895	IG	1.575	2.575	0.750	40	65	19
29500-4472	IG	4.938	6.000	0.750	125	152	19	29500-4969	IG	2.756	3.543	0.750	70	90	19
29500-4476	IG	2.441	3.948	0.750	62	100	19	29500-4974	IG	3.150	4.331	0.750	80	110	19
29500-4480	IG	4.250	5.500	0.750	108	140	19	29500-4976	IG	3.543	4.331	0.750	90	110	19
29500-4485	IG	2.188	5.125	0.750	56	130	19	29500-4979	IG	3.740	4.921	0.750	95	125	19
29500-4495	IG	4.437	5.500	0.750	113	140	19	29500-4980	IG	3.938	4.724	0.750	100	120	19
29500-4497	IG	4.166	5.500	0.750	106	140	19	29500-4981	IG	4.134	5.118	0.750	105	130	19
29500-4502	IG	1.100	2.625	0.750	28	67	19	29500-4984	IG	4.331	5.512	0.750	110	140	19
29500-4504	IG	5.438	6.875	0.750	138	175	19	29500-4994	IG	5.512	6.693	0.750	140	170	19
29500-4506	IG	3.740	4.740	0.750	95	120	19	29500-4996	IG	5.906	7.087	0.750	150	180	19
29500-4507	IG	3.000	4.375	0.750	76	111	19	29500-4998	IG	6.299	7.480	0.750	160	190	19
29500-4538	IG	1.188	2.250	0.750	30	57	19	29500-5000	IG	6.693	7.874	0.750	170	200	19
29500-4542	IG	6.375	7.375	0.750	162	187	19	29500-5005	IG	2.750	3.720	0.750	70	94	19
29500-4559	IG	1.188	2.000	0.750	30	51	19	29500-5066	IG	3.125	4.250	0.750	79	108	19
29500-4560	IG	1.813	2.875	0.750	46	73	19	29500-5087	IG	3.335	4.335	0.750	85	110	19
29500-4562	IG	3.688	4.750	0.750	94	121	19	29500-5119	IG	4.875	7.000	0.750	124	178	19
29500-4571	IG	1.875	3.250	0.750	48	83	19	29500-5143	IG	2.500	4.000	0.750	64	102	19
29500-4592	IG	2.500	4.938	0.750	64	125	19	29500-5158	IG	7.874	8.874	0.750	200	225	19
29500-4619	IG	2.375	3.875	0.750	60	98	19	29500-5159	IG	4.724	5.724	0.750	120	145	19
29500-4640	IG	3.938	6.375	0.750	100	162	19	29500-5293	IG	3.150	4.724	0.750	80	120	19
29500-4641	IG	3.938	4.999	0.750	100	127	19	29500-5312	IG	2.875	4.250	0.750	73	108	19
29500-4647	IG	4.938	7.000	0.750	125	178	19	29500-5328	IG	1.810	2.875	0.750	46	73	19
29500-4648	IG	2.938	4.000	0.750	75	102	19	29500-5367	IG	2.559	4.331	0.750	65	110	19
29500-4649	IG	3.937	4.921	0.750	100	125	19	29500-5383	IG	4.331	5.331	0.750	110	135	19
29500-4656	IG	1.770	2.875	0.750	45	73	19	29500-5385	IG	5.187	7.000	0.750	132	178	19
29500-4675	IG	2.990	4.000	0.750	76	102	19	29500-5415	IG	1.688	2.625	0.750	43	67	19

All dimensions are in inches. Preferred sizes are indicated with **bold** type face. Sizes listed are for standard nitrile elements, except Models 25 and 62 which have PTFE elements. Other material available on inquiry only.

## Oil Seals by Model Number

Product Code	Model	Inches			MM			Product Code	Model	Inches			MM		
		ID	OD	Width	ID	OD	Width			ID	OD	Width	ID	OD	Width
29500-5479	IG	3.543	4.543	0.750	90	115	19	29502-2051	IG	4.563	5.563	0.750	116	141	19
29500-5480	IG	4.000	5.250	0.750	102	133	19	29502-2063	IG	2.750	3.875	0.750	70	98	19
29500-5481	IG	6.000	7.375	0.750	152	187	19	29502-2141	IG	2.438	3.314	0.750	62	84	19
29500-5487	IG	3.149	4.724	0.750	80	120	19	29502-2175	IG	3.000	4.000	0.750	76	102	19
29500-5512	IG	2.362	3.362	0.750	60	85	19	29502-2952	IG	3.741	4.922	0.750	95	125	19
29500-5522	IG	6.625	7.625	0.750	168	194	19	29502-2953	IG	4.145	5.145	0.750	105	131	19
29500-5542	IG	2.165	3.071	0.750	55	78	19	29502-3253	IG	3.149	4.173	0.750	80	106	19
29500-5569	IG	2.480	3.480	0.750	63	88	19	29502-3301	IG	7.874	9.055	0.750	200	230	19
29500-5619	IG	2.000	3.250	0.750	51	83	19	29502-3349	IG	2.000	3.000	0.750	51	76	19
29500-5642	IG	6.750	8.125	0.750	171	206	19	29502-3362	IG	6.000	7.000	0.750	152	178	19
29500-5645	IG	5.000	7.000	0.750	127	178	19	29502-3370	IG	6.000	7.500	0.750	152	191	19
29500-5684	IG	1.250	2.875	0.750	32	73	19	29502-3405	IG	6.250	7.750	0.750	159	197	19
29500-5699	IG	4.375	5.500	0.750	111	140	19	29502-3443	IG	1.890	2.835	0.750	48	72	19
29500-5700	IG	3.500	4.381	0.750	89	111	19	29502-3453	IG	7.000	8.000	0.750	178	203	19
29500-5713	IG	1.938	2.688	0.750	49	68	19	29502-3465	IG	6.750	8.250	0.750	171	210	19
29500-5716	IG	4.250	5.376	0.750	108	137	19	29502-3467	IG	6.750	8.000	0.750	171	203	19
29500-5722	IG	2.187	2.937	0.750	56	75	19	29502-3497	IG	7.000	8.250	0.750	178	210	19
29500-5767	IG	4.331	5.125	0.750	110	130	19	29502-3501	IG	7.000	8.500	0.750	178	216	19
29500-5772	IG	2.625	3.750	0.750	67	95	19	29502-3553	IG	7.500	9.000	0.750	191	229	19
29500-5808	IG	8.625	10.250	0.750	219	260	19	29502-3585	IG	1.875	2.875	0.750	48	73	19
29500-5955	IG	9.842	10.593	0.750	250	269	19	29502-3601	IG	8.000	9.500	0.750	203	241	19
29500-5962	IG	3.543	4.528	0.750	90	115	19	29502-3803	IG	7.500	8.500	0.750	191	216	19
29500-6013	IG	1.625	2.875	0.750	41	73	19	29502-3979	IG	9.500	11.000	0.750	241	279	19
29500-6019	IG	1.181	2.992	0.750	30	76	19	29502-4104	IG	1.375	2.835	0.750	35	72	19
29500-6025	IG	0.896	2.992	0.750	23	76	19	29502-4107	IG	1.750	2.875	0.750	44	73	19
29500-6052	IG	3.310	4.310	0.750	84	109	19	29502-4108	IG	1.125	2.000	0.750	29	51	19
29500-6053	IG	2.112	3.112	0.750	54	79	19	29502-4109	IG	2.125	2.875	0.750	54	73	19
29500-6071	IG	3.000	4.250	0.750	76	108	19	29502-4110	IG	1.875	2.750	0.750	48	70	19
29500-6119	IG	3.750	4.875	0.750	95	124	19	29502-4111	IG	2.500	3.250	0.750	64	83	19
29500-6138	IG	2.756	3.976	0.750	70	101	19	29502-4112	IG	2.375	3.250	0.750	60	83	19
29500-6157	IG	2.165	4.724	0.750	55	120	19	29502-4113	IG	3.313	4.125	0.750	84	105	19
29500-6158	IG	2.863	4.724	0.750	73	120	19	29502-4114	IG	3.125	4.125	0.750	79	105	19
29500-6173	IG	6.750	8.125	0.750	171	206	19	29502-4115	IG	4.313	5.500	0.750	110	140	19
29500-6335	IG	4.250	6.250	0.750	108	159	19	29502-4116	IG	4.125	5.250	0.750	105	133	19
29500-6408	IG	3.500	4.750	0.750	89	121	19	29502-4117	IG	1.437	2.250	0.750	36	57	19
29500-6445	IG	5.063	6.125	0.750	129	156	19	29502-4118	IG	1.375	2.125	0.750	35	54	19
29500-6490	IG	1.180	2.250	0.750	30	57	19	29502-4119	IG	2.063	3.000	0.750	52	76	19
29500-6491	IG	1.889	2.828	0.750	48	72	19	29502-4120	IG	1.938	3.000	0.750	49	76	19
29500-6710	IG	5.512	6.654	0.750	140	169	19	29502-4123	IG	0.875	1.625	0.750	22	41	19
29500-7282	IG	7.625	8.625	0.750	194	219	19	29502-4124	IG	1.875	2.625	0.750	48	67	19
29500-7295	IG	4.724	6.500	0.750	120	165	19	29502-4125	IG	2.625	3.677	0.750	67	93	19
29500-7467	IG	2.756	4.921	0.750	70	125	19	29502-4126	IG	2.625	3.688	0.750	67	94	19
29500-9217	IG	4.000	5.500	0.750	102	140	19	29502-4138	IG	1.000	2.000	0.750	25	51	19
29501-4141	IG	1.375	2.375	0.750	35	60	19	29502-4139	IG	1.125	2.125	0.750	29	54	19
29501-4411	IG	1.750	3.543	0.750	44	90	19	29502-4140	IG	1.250	2.250	0.750	32	57	19
29501-4412	IG	1.750	4.725	0.750	44	120	19	29502-4141	IG	1.375	2.375	0.750	35	60	19
29501-4413	IG	2.437	5.120	0.750	62	130	19	29502-4143	IG	1.500	2.500	0.750	38	64	19
29501-4857	IG	1.250	2.375	0.750	32	60	19	29502-4144	IG	1.625	2.625	0.750	41	67	19
29502-0774	IG	3.375	4.375	0.750	86	111	19	29502-4145	IG	1.750	2.750	0.750	44	70	19
29502-1253	IG	1.575	3.543	0.740	40	90	19	29502-4146	IG	2.125	3.125	0.750	54	79	19
29502-1254	IG	2.740	4.000	0.750	70	102	19	29502-4148	IG	2.250	3.250	0.750	57	83	19
29502-1271	IG	1.474	2.375	0.750	37	60	19	29502-4149	IG	2.375	3.375	0.750	60	86	19
29502-1309	IG	0.875	1.625	0.750	22	41	19	29502-4150	IG	2.500	3.500	0.750	64	89	19
29502-1505	IG	0.978	1.750	0.750	25	44	19	29502-4151	IG	2.625	3.625	0.750	67	92	19
29502-1745	IG	2.125	3.625	0.750	54	92	19	29502-4152	IG	2.750	3.750	0.750	70	95	19
29502-1864	IG	5.375	6.375	0.750	137	162	19	29502-4153	IG	2.875	3.875	0.750	73	98	19

All dimensions are in inches. Preferred sizes are indicated with **bold** type face. Sizes listed are for standard nitrile elements, except Models 25 and 62 which have PTFE elements. Other material available on inquiry only.

**Oil Seals by Model Number**

Product Code	Model	Inches			MM			Product Code	Model	Inches			MM		
		ID	OD	Width	ID	OD	Width			ID	OD	Width	ID	OD	Width
29502-4154	IG	3.250	4.250	0.750	83	108	19	29502-4285	IG	3.063	4.063	0.750	78	103	19
29502-4156	IG	3.500	4.500	0.750	89	114	19	29502-4286	IG	3.188	4.188	0.750	81	106	19
29502-4157	IG	3.625	4.625	0.750	92	117	19	29502-4287	IG	3.313	4.313	0.750	84	110	19
29502-4158	IG	3.750	4.750	0.750	95	121	19	29502-4288	IG	3.437	4.437	0.750	87	113	19
29502-4159	IG	3.875	4.875	0.750	98	124	19	29502-4289	IG	3.563	4.563	0.750	91	116	19
29502-4160	IG	4.000	5.000	0.750	102	127	19	29502-4290	IG	3.688	4.688	0.750	94	119	19
29502-4161	IG	4.125	5.125	0.750	105	130	19	29502-4291	IG	3.812	4.812	0.750	97	122	19
29502-4163	IG	4.250	5.250	0.750	108	133	19	29502-4292	IG	3.938	4.938	0.750	100	125	19
29502-4164	IG	4.375	5.375	0.750	111	137	19	29502-4293	IG	4.063	5.063	0.750	103	129	19
29502-4165	IG	4.500	5.500	0.750	114	140	19	29502-4295	IG	4.188	5.188	0.750	106	132	19
29502-4166	IG	4.625	5.625	0.750	117	143	19	29502-4296	IG	4.313	5.313	0.750	110	135	19
29502-4167	IG	4.750	5.750	0.750	121	146	19	29502-4298	IG	4.688	5.688	0.750	119	144	19
29502-4168	IG	4.875	5.875	0.750	124	149	19	29502-4300	IG	4.938	5.938	0.750	125	151	19
29502-4169	IG	5.000	6.000	0.750	127	152	19	29502-4301	IG	5.063	6.063	0.750	129	154	19
29502-4170	IG	5.125	6.125	0.750	130	156	19	29502-4304	IG	5.438	6.438	0.750	138	164	19
29502-4171	IG	5.250	6.250	0.750	133	159	19	29502-4306	IG	5.688	6.688	0.750	144	170	19
29502-4172	IG	5.500	6.500	0.750	140	165	19	29502-4308	IG	5.938	6.938	0.750	151	176	19
29502-4173	IG	5.625	6.625	0.750	143	168	19	29502-4312	IG	6.250	7.250	0.750	159	184	19
29502-4174	IG	5.750	6.750	0.750	146	171	19	29502-4315	IG	6.438	7.438	0.750	164	189	19
29502-4177	IG	1.437	2.437	0.750	36	62	19	29502-4316	IG	6.500	7.500	0.750	165	191	19
29502-4179	IG	2.625	3.675	0.750	67	93	19	29502-4319	IG	1.750	2.500	0.750	44	64	19
29502-4181	IG	1.125	2.441	0.750	29	62	19	29502-4320	IG	1.375	2.438	0.750	35	62	19
29502-4182	IG	1.000	1.750	0.750	25	44	19	29502-4322	IG	1.125	1.875	0.750	29	48	19
29502-4185	IG	1.250	2.000	0.750	32	51	19	29502-4323	IG	1.750	2.625	0.750	44	67	19
29502-4186	IG	3.250	4.000	0.750	83	102	19	29502-4324	IG	2.375	3.125	0.750	60	79	19
29502-4187	IG	2.750	3.500	0.750	70	89	19	29502-4326	IG	2.000	2.750	0.750	51	70	19
29502-4189	IG	1.890	2.756	0.750	48	70	19	29502-4327	IG	1.625	2.500	0.750	41	64	19
29502-4190	IG	2.165	3.150	0.750	55	80	19	29502-4328	IG	3.000	3.875	0.750	76	98	19
29502-4191	IG	2.362	3.346	0.750	60	85	19	29502-4330	IG	1.875	2.686	0.750	48	68	19
29502-4192	IG	2.756	3.740	0.750	70	95	19	29502-4331	IG	2.875	4.000	0.750	73	102	19
29502-4193	IG	3.346	4.331	0.750	85	110	19	29502-4332	IG	2.625	3.484	0.750	67	88	19
29502-4203	IG	5.000	6.250	0.750	127	159	19	29502-4336	IG	1.185	2.442	0.750	30	62	19
29502-4204	IG	2.187	3.000	0.750	56	76	19	29502-4338	IG	2.280	3.280	0.750	58	83	19
29502-4205	IG	2.125	3.000	0.750	54	76	19	29502-4348	IG	1.750	3.938	0.750	44	100	19
29502-4208	IG	5.250	6.500	0.750	133	165	19	29502-4350	IG	1.766	2.750	0.750	45	70	19
29502-4211	IG	5.875	7.125	0.750	149	181	19	29502-4351	IG	2.355	3.870	0.750	60	98	19
29502-4212	IG	4.500	6.000	0.750	114	152	19	29502-4352	IG	3.000	4.910	0.750	76	125	19
29502-4213	IG	4.500	5.250	0.750	114	133	19	29502-4353	IG	2.500	4.375	0.750	64	111	19
29502-4214	IG	3.500	4.375	0.750	89	111	19	29502-4354	IG	3.375	5.250	0.750	86	133	19
29502-4217	IG	2.000	3.125	0.750	51	79	19	29502-4356	IG	1.900	3.500	0.750	48	89	19
29502-4218	IG	4.750	6.000	0.750	121	152	19	29502-4361	IG	3.000	4.125	0.750	76	105	19
29502-4235	IG	1.500	2.250	0.750	38	57	19	29502-4366	IG	4.188	5.250	0.750	106	133	19
29502-4257	IG	2.313	3.313	0.750	59	84	19	29502-4367	IG	2.250	3.190	0.750	57	81	19
29502-4270	IG	0.938	1.938	0.750	24	49	19	29502-4374	IG	2.500	3.750	0.750	64	95	19
29502-4272	IG	1.188	2.188	0.750	30	56	19	29502-4375	IG	0.938	2.000	0.750	24	51	19
29502-4274	IG	1.563	2.563	0.750	40	65	19	29502-4379	IG	3.375	4.500	0.750	86	114	19
29502-4275	IG	1.688	2.688	0.750	43	68	19	29502-4385	IG	3.375	4.125	0.750	86	105	19
29502-4276	IG	1.813	2.813	0.750	46	71	19	29502-4386	IG	2.875	4.625	0.750	73	117	19
29502-4277	IG	1.938	2.938	0.750	49	75	19	29502-4391	IG	4.500	5.750	0.750	114	146	19
29502-4278	IG	2.063	3.063	0.750	52	78	19	29502-4402	IG	1.127	2.000	0.750	29	51	19
29502-4279	IG	2.187	3.187	0.750	56	81	19	29502-4403	IG	2.159	3.000	0.750	55	76	19
29502-4280	IG	2.438	3.438	0.750	62	87	19	29502-4408	IG	2.250	2.997	0.750	57	76	19
29502-4281	IG	2.562	3.562	0.750	65	90	19	29502-4412	IG	1.750	4.725	0.750	44	120	19
29502-4282	IG	2.688	3.688	0.750	68	94	19	29502-4422	IG	1.180	2.835	0.750	30	72	19
29502-4283	IG	2.812	3.812	0.750	71	97	19	29502-4425	IG	3.250	4.500	0.750	83	114	19
29502-4284	IG	2.938	3.938	0.750	75	100	19	29502-4438	IG	2.625	3.500	0.750	67	89	19

*All dimensions are in inches. Preferred sizes are indicated with **bold** type face. Sizes listed are for standard nitrile elements, except Models 25 and 62 which have PTFE elements. Other material available on inquiry only.*

## Oil Seals by Model Number

Product Code	Model	Inches			MM			Product Code	Model	Inches			MM		
		ID	OD	Width	ID	OD	Width			ID	OD	Width	ID	OD	Width
29502-4439	IG	1.654	2.625	0.750	42	67	19	29502-4665	IG	1.965	3.000	0.750	50	76	19
29502-4440	IG	1.457	2.500	0.750	37	64	19	29502-4666	IG	2.400	3.500	0.750	61	89	19
29502-4441	IG	1.575	3.071	0.750	40	78	19	29502-4675	IG	2.990	4.000	0.750	76	102	19
29502-4448	IG	0.787	1.575	0.750	20	40	19	29502-4678	IG	1.771	3.937	0.750	45	100	19
29502-4457	IG	2.990	3.750	0.750	76	95	19	29502-4679	IG	1.625	2.438	0.750	41	62	19
29502-4462	IG	2.250	3.000	0.750	57	76	19	29502-4680	IG	1.250	2.438	0.750	32	62	19
29502-4470	IG	1.563	2.502	0.750	40	64	19	29502-4683	IG	2.500	3.543	0.750	64	90	19
29502-4472	IG	4.938	6.000	0.750	125	152	19	29502-4684	IG	1.181	2.362	0.750	30	60	19
29502-4477	IG	3.313	4.375	0.750	84	111	19	29502-4687	IG	2.350	3.375	0.750	60	86	19
29502-4478	IG	2.313	3.250	0.750	59	83	19	29502-4688	IG	1.950	3.000	0.750	50	76	19
29502-4479	IG	2.875	3.750	0.750	73	95	19	29502-4689	IG	1.370	2.375	0.750	35	60	19
29502-4480	IG	4.250	5.500	0.750	108	140	19	29502-4692	IG	1.760	2.875	0.750	45	73	19
29502-4483	IG	2.530	3.287	0.750	64	83	19	29502-4693	IG	2.360	3.375	0.750	60	86	19
29502-4489	IG	2.053	3.000	0.750	52	76	19	29502-4700	IG	1.969	2.953	0.750	50	75	19
29502-4490	IG	1.772	2.756	0.750	45	70	19	29502-4704	IG	1.875	3.938	0.750	48	100	19
29502-4491	IG	3.535	4.500	0.750	90	114	19	29502-4706	IG	2.750	4.000	0.750	70	102	19
29502-4492	IG	2.165	2.953	0.750	55	75	19	29502-4708	IG	2.750	3.625	0.750	70	92	19
29502-4507	IG	3.000	4.375	0.750	76	111	19	29502-4709	IG	3.000	3.750	0.750	76	95	19
29502-4529	IG	1.378	2.165	0.750	35	55	19	29502-4714	IG	1.938	2.875	0.750	49	73	19
29502-4532	IG	2.559	3.346	0.750	65	85	19	29502-4715	IG	3.550	4.550	0.750	90	116	19
29502-4538	IG	1.188	2.250	0.750	30	57	19	29502-4716	IG	1.920	3.000	0.750	49	76	19
29502-4541	IG	2.685	3.998	0.750	68	102	19	29502-4720	IG	1.173	2.441	0.750	30	62	19
29502-4542	IG	6.375	7.498	0.750	162	190	19	29502-4721	IG	2.559	3.543	0.750	65	90	19
29502-4544	IG	2.938	4.125	0.750	75	105	19	29502-4722	IG	3.345	4.320	0.750	85	110	19
29502-4546	IG	1.755	3.358	0.750	45	85	19	29502-4727	IG	2.375	3.544	0.750	60	90	19
29502-4548	IG	2.875	3.625	0.750	73	92	19	29502-4728	IG	3.150	4.135	0.750	80	105	19
29502-4550	IG	3.188	4.250	0.750	81	108	19	29502-4730	IG	1.375	3.625	0.750	35	92	19
29502-4553	IG	1.969	3.543	0.750	50	90	19	29502-4731	IG	0.875	2.750	0.750	22	70	19
29502-4559	IG	1.188	2.000	0.750	30	51	19	29502-4735	IG	5.500	10.250	0.750	140	260	19
29502-4560	IG	1.812	2.875	0.750	46	73	19	29502-4739	IG	7.750	10.250	0.750	197	260	19
29502-4572	IG	4.063	5.125	0.750	103	130	19	29502-4742	IG	1.450	2.360	0.750	37	60	19
29502-4574	IG	3.150	4.250	0.750	80	108	19	29502-4749	IG	2.953	3.938	0.750	75	100	19
29502-4576	IG	3.500	4.625	0.750	89	117	19	29502-4756	IG	7.480	8.661	0.750	190	220	19
29502-4581	IG	1.772	2.953	0.750	45	75	19	29502-4758	IG	3.543	4.724	0.750	90	120	19
29502-4589	IG	2.746	3.746	0.750	70	95	19	29502-4769	IG	4.298	5.298	0.750	109	135	19
29502-4590	IG	2.158	3.158	0.750	55	80	19	29502-4770	IG	2.942	3.942	0.750	75	100	19
29502-4591	IG	1.962	2.962	0.750	50	75	19	29502-4771	IG	1.563	2.623	0.750	40	67	19
29502-4594	IG	2.938	4.000	0.750	75	102	19	29502-4772	IG	2.554	3.554	0.750	65	90	19
29502-4595	IG	1.500	2.254	0.750	38	57	19	29502-4775	IG	3.125	3.875	0.750	79	98	19
29502-4601	IG	2.352	3.375	0.750	60	86	19	29502-4777	IG	3.125	3.938	0.750	79	100	19
29502-4602	IG	3.825	4.875	0.750	97	124	19	29502-4781	IG	2.000	2.875	0.750	51	73	19
29502-4603	IG	3.420	4.500	0.750	87	114	19	29502-4786	IG	2.165	3.189	0.750	55	81	19
29502-4604	IG	4.520	5.500	0.750	115	140	19	29502-4798	IG	3.150	3.937	0.750	80	100	19
29502-4609	IG	2.350	3.350	0.750	60	85	19	29502-4805	IG	2.155	3.155	0.750	55	80	19
29502-4615	IG	1.625	2.375	0.750	41	60	19	29502-4806	IG	2.375	3.500	0.750	60	89	19
29502-4617	IG	2.125	3.188	0.750	54	81	19	29502-4807	IG	2.125	3.250	0.750	54	83	19
29502-4622	IG	3.850	4.875	0.750	98	124	19	29502-4808	IG	1.575	2.441	0.750	40	62	19
29502-4623	IG	2.400	3.375	0.750	61	86	19	29502-4809	IG	1.875	3.000	0.750	48	76	19
29502-4630	IG	2.558	3.558	0.750	65	90	19	29502-4810	IG	1.500	2.375	0.750	38	60	19
29502-4638	IG	2.160	3.195	0.750	55	81	19	29502-4812	IG	2.228	3.228	0.750	57	82	19
29502-4641	IG	3.937	4.999	0.750	100	127	19	29502-4813	IG	2.258	3.258	0.750	57	83	19
29502-4649	IG	3.938	4.921	0.750	100	125	19	29502-4818	IG	2.710	3.710	0.750	69	94	19
29502-4650	IG	3.438	4.500	0.750	87	114	19	29502-4819	IG	1.969	2.756	0.750	50	70	19
29502-4655	IG	3.156	4.250	0.750	80	108	19	29502-4822	IG	2.953	3.740	0.750	75	95	19
29502-4658	IG	2.997	3.831	0.750	76	97	19	29502-4825	IG	1.614	2.402	0.750	41	61	19
29502-4664	IG	1.925	3.000	0.750	49	76	19	29502-4826	IG	3.312	4.213	0.750	84	107	19

All dimensions are in inches. Preferred sizes are indicated with **bold** type face.

Sizes listed are for standard nitrile elements, except Models 25 and 62 which have PTFE elements. Other material available on inquiry only.

**Oil Seals by Model Number**

Product Code	Model	Inches			MM			Product Code	Model	Inches			MM		
		ID	OD	Width	ID	OD	Width			ID	OD	Width	ID	OD	Width
29502-4828	IG	1.625	2.525	0.750	41	64	19	29502-5071	IG	1.125	2.050	0.750	29	52	19
29502-4831	IG	5.906	6.906	0.750	150	175	19	29502-5072	IG	3.937	4.960	0.750	100	126	19
29502-4837	IG	4.851	5.886	0.750	123	150	19	29502-5073	IG	2.625	4.000	0.750	67	102	19
29502-4838	IG	2.938	4.295	0.750	75	109	19	29502-5076	IG	2.354	3.354	0.750	60	85	19
29502-4843	IG	1.563	2.500	0.750	40	64	19	29502-5080	IG	2.625	3.670	0.750	67	93	19
29502-4846	IG	2.441	3.441	0.750	62	87	19	29502-5081	IG	2.375	3.255	0.750	60	83	19
29502-4847	IG	2.432	3.432	0.750	62	87	19	29502-5090	IG	3.464	4.500	0.750	88	114	19
29502-4850	IG	2.938	3.750	0.750	75	95	19	29502-5094	IG	6.438	7.687	0.750	164	195	19
29502-4859	IG	3.937	5.118	0.750	100	130	19	29502-5101	IG	1.250	2.875	0.750	32	73	19
29502-4860	IG	1.260	2.165	0.750	32	55	19	29502-5123	IG	4.313	5.687	0.750	110	144	19
29502-4874	IG	2.250	3.625	0.750	57	92	19	29502-5127	IG	2.938	4.003	0.750	75	102	19
29502-4877	IG	1.562	2.441	0.750	40	62	19	29502-5128	IG	3.938	5.250	0.750	100	133	19
29502-4880	IG	1.968	2.718	0.750	50	69	19	29502-5132	IG	4.450	5.437	0.750	113	138	19
29502-4883	IG	2.360	3.360	0.750	60	85	19	29502-5133	IG	3.420	4.375	0.750	87	111	19
29502-4884	IG	4.125	5.375	0.750	105	137	19	29502-5135	IG	1.772	2.622	0.750	45	67	19
29502-4887	IG	2.450	3.450	0.750	62	88	19	29502-5141	IG	3.150	4.150	0.750	80	105	19
29502-4888	IG	3.140	4.140	0.750	80	105	19	29502-5143	IG	2.500	4.000	0.750	64	102	19
29502-4966	IG	2.559	3.937	0.750	65	100	19	29502-5148	IG	1.200	2.000	0.750	30	51	19
29502-4969	IG	2.756	3.543	0.750	70	90	19	29502-5149	IG	1.180	2.000	0.750	30	51	19
29502-4971	IG	2.835	3.740	0.750	72	95	19	29502-5154	IG	2.619	3.682	0.750	67	94	19
29502-4974	IG	3.150	4.331	0.750	80	110	19	29502-5158	IG	7.874	8.874	0.750	200	225	19
29502-4978	IG	3.740	4.724	0.750	95	120	19	29502-5159	IG	4.724	5.724	0.750	120	145	19
29502-4980	IG	3.938	4.724	0.750	100	120	19	29502-5160	IG	2.015	3.000	0.750	51	76	19
29502-4981	IG	4.134	5.118	0.750	105	130	19	29502-5161	IG	2.375	3.371	0.750	60	86	19
29502-4982	IG	4.134	5.512	0.750	105	140	19	29502-5163	IG	2.625	3.543	0.750	67	90	19
29502-4983	IG	4.331	5.118	0.750	110	130	19	29502-5165	IG	3.563	4.500	0.750	91	114	19
29502-4984	IG	4.331	5.512	0.750	110	140	19	29502-5166	IG	1.180	2.180	0.750	30	55	19
29502-4985	IG	4.528	5.512	0.750	115	140	19	29502-5167	IG	1.754	2.754	0.750	45	70	19
29502-4987	IG	4.724	5.906	0.750	120	150	19	29502-5168	IG	1.967	2.967	0.750	50	75	19
29502-4989	IG	4.921	5.906	0.750	125	150	19	29502-5169	IG	3.158	4.158	0.750	80	106	19
29502-4991	IG	5.118	6.299	0.750	130	160	19	29502-5203	IG	4.000	4.875	0.750	102	124	19
29502-4993	IG	5.315	6.693	0.750	135	170	19	29502-5210	IG	3.605	4.625	0.750	92	117	19
29502-4994	IG	5.512	6.693	0.750	140	170	19	29502-5211	IG	2.248	3.150	0.750	57	80	19
29502-4996	IG	5.906	7.087	0.750	150	180	19	29502-5213	IG	3.189	4.252	0.750	81	108	19
29502-4998	IG	6.299	7.480	0.750	160	190	19	29502-5214	IG	1.250	3.150	0.750	32	80	19
29502-5001	IG	2.540	3.540	0.750	65	90	19	29502-5215	IG	3.000	5.875	0.750	76	149	19
29502-5002	IG	3.438	4.460	0.750	87	113	19	29502-5227	IG	4.875	6.000	0.750	124	152	19
29502-5003	IG	2.125	3.375	0.750	54	86	19	29502-5258	IG	3.687	4.560	0.750	94	116	19
29502-5005	IG	2.750	3.720	0.750	70	94	19	29502-5268	IG	1.437	2.694	0.750	36	68	19
29502-5007	IG	1.187	2.437	0.750	30	62	19	29502-5274	IG	1.937	2.750	0.750	49	70	19
29502-5024	IG	1.375	2.625	0.750	35	67	19	29502-5279	IG	5.500	6.693	0.750	140	170	19
29502-5039	IG	1.125	2.375	0.750	29	60	19	29502-5285	IG	6.000	6.750	0.750	152	171	19
29502-5040	IG	1.875	3.125	0.750	48	79	19	29502-5287	IG	6.750	7.750	0.750	171	197	19
29502-5042	IG	2.500	3.623	0.750	64	92	19	29502-5288	IG	2.437	3.750	0.750	62	95	19
29502-5043	IG	2.380	3.375	0.750	60	86	19	29502-5289	IG	2.400	3.438	0.750	61	87	19
29502-5044	IG	3.188	4.313	0.750	81	110	19	29502-5292	IG	1.562	3.548	0.750	40	90	19
29502-5045	IG	2.500	3.875	0.750	64	98	19	29502-5293	IG	3.150	4.724	0.750	80	120	19
29502-5051	IG	1.573	2.573	0.750	40	65	19	29502-5296	IG	3.634	4.625	0.750	92	117	19
29502-5053	IG	2.161	3.161	0.750	55	80	19	29502-5307	IG	2.188	3.250	0.750	56	83	19
29502-5055	IG	3.142	4.142	0.750	80	105	19	29502-5312	IG	2.875	4.250	0.750	73	108	19
29502-5056	IG	2.240	3.240	0.750	57	82	19	29502-5313	IG	3.149	4.122	0.750	80	105	19
29502-5057	IG	3.731	4.731	0.750	95	120	19	29502-5314	IG	3.580	4.916	0.750	91	125	19
29502-5058	IG	3.375	4.625	0.750	86	117	19	29502-5329	IG	2.819	3.813	0.750	72	97	19
29502-5059	IG	2.317	3.375	0.750	59	86	19	29502-5333	IG	3.000	4.500	0.750	76	114	19
29502-5065	IG	2.625	4.003	0.750	67	102	19	29502-5334	IG	1.375	2.500	0.750	35	64	19
29502-5066	IG	3.125	4.250	0.750	79	108	19	29502-5342	IG	2.165	3.165	0.750	55	80	19

All dimensions are in inches. Preferred sizes are indicated with **bold** type face.  
 Sizes listed are for standard nitrile elements, except Models 25 and 62 which have PTFE elements. Other material available on inquiry only.

## Oil Seals by Model Number

Product Code	Model	Inches			MM			Product Code	Model	Inches			MM		
		ID	OD	Width	ID	OD	Width			ID	OD	Width	ID	OD	Width
29502-5352	IG	2.438	3.188	0.750	62	81	19	29502-5558	IG	2.500	4.724	0.750	64	120	19
29502-5362	IG	3.125	4.003	0.750	79	102	19	29502-5565	IG	6.875	7.875	0.750	175	200	19
29502-5364	IG	3.750	5.000	0.750	95	127	19	29502-5569	IG	2.480	3.480	0.750	63	88	19
29502-5367	IG	2.559	4.331	0.750	65	110	19	29502-5570	IG	1.938	3.149	0.750	49	80	19
29502-5372	IG	1.496	2.362	0.750	38	60	19	29502-5571	IG	3.981	4.987	0.750	101	127	19
29502-5381	IG	3.500	5.250	0.750	89	133	19	29502-5572	IG	2.625	3.535	0.750	67	90	19
29502-5383	IG	4.331	5.331	0.750	110	135	19	29502-5578	IG	1.500	2.864	0.750	38	73	19
29502-5385	IG	5.187	7.000	0.750	132	178	19	29502-5579	IG	2.500	5.118	0.750	64	130	19
29502-5386	IG	1.375	2.812	0.750	35	71	19	29502-5583	IG	6.125	7.625	0.750	156	194	19
29502-5395	IG	3.071	4.331	0.750	78	110	19	29502-5584	IG	1.181	2.441	0.750	30	62	19
29502-5396	IG	2.820	3.843	0.750	72	98	19	29502-5585	IG	2.375	3.130	0.750	60	80	19
29502-5397	IG	3.937	4.990	0.750	100	127	19	29502-5589	IG	2.953	4.175	0.750	75	106	19
29502-5398	IG	3.346	4.335	0.750	85	110	19	29502-5592	IG	3.438	5.000	0.750	87	127	19
29502-5403	IG	3.008	4.008	0.750	76	102	19	29502-5594	IG	1.772	2.750	0.750	45	70	19
29502-5404	IG	2.718	3.700	0.750	69	94	19	29502-5596	IG	1.468	2.375	0.750	37	60	19
29502-5410	IG	4.750	5.500	0.750	121	140	19	29502-5599	IG	1.181	1.969	0.750	30	50	19
29502-5413	IG	2.938	4.500	0.750	75	114	19	29502-5602	IG	2.437	3.250	0.750	62	83	19
29502-5415	IG	1.688	2.625	0.750	43	67	19	29502-5607	IG	3.375	4.400	0.750	86	112	19
29502-5419	IG	2.250	3.125	0.750	57	79	19	29502-5611	IG	2.770	3.770	0.750	70	96	19
29502-5420	IG	2.726	3.500	0.750	69	89	19	29502-5613	IG	4.318	5.318	0.750	110	135	19
29502-5423	IG	3.000	5.000	0.750	76	127	19	29502-5614	IG	2.438	3.350	0.750	62	85	19
29502-5424	IG	5.250	6.000	0.750	133	152	19	29502-5615	IG	1.337	2.337	0.750	34	59	19
29502-5436	IG	1.438	2.500	0.750	37	64	19	29502-5618	IG	7.087	8.087	0.750	180	205	19
29502-5443	IG	2.345	3.375	0.750	60	86	19	29502-5619	IG	2.000	3.250	0.750	51	83	19
29502-5455	IG	3.016	4.016	0.750	77	102	19	29502-5621	IG	1.250	3.125	0.750	32	79	19
29502-5463	IG	2.225	3.225	0.750	57	82	19	29502-5622	IG	3.150	4.500	0.750	80	114	19
29502-5469	IG	2.925	3.925	0.750	74	100	19	29502-5628	IG	2.498	3.368	0.750	63	86	19
29502-5470	IG	1.125	2.062	0.750	29	52	19	29502-5632	IG	1.969	2.992	0.750	50	76	19
29502-5471	IG	1.750	2.700	0.750	44	69	19	29502-5634	IG	2.062	3.125	0.750	52	79	19
29502-5472	IG	2.625	4.050	0.750	67	103	19	29502-5636	IG	4.640	5.640	0.750	118	143	19
29502-5473	IG	2.356	3.780	0.750	60	96	19	29502-5646	IG	2.559	4.134	0.750	65	105	19
29502-5476	IG	3.812	4.875	0.750	97	124	19	29502-5647	IG	2.775	3.775	0.750	70	96	19
29502-5479	IG	3.543	4.543	0.750	90	115	19	29502-5648	IG	3.925	4.925	0.750	100	125	19
29502-5480	IG	4.000	5.250	0.750	102	133	19	29502-5653	IG	2.312	3.500	0.750	59	89	19
29502-5481	IG	6.000	7.375	0.750	152	187	19	29502-5657	IG	3.100	4.100	0.750	79	104	19
29502-5489	IG	1.438	2.375	0.750	37	60	19	29502-5658	IG	3.600	4.600	0.750	91	117	19
29502-5511	IG	1.168	2.437	0.750	30	62	19	29502-5663	IG	2.559	3.500	0.750	65	89	19
29502-5513	IG	4.120	5.000	0.750	105	127	19	29502-5666	IG	2.312	3.375	0.750	59	86	19
29502-5517	IG	1.145	2.000	0.750	29	51	19	29502-5667	IG	6.875	8.250	0.750	175	210	19
29502-5520	IG	1.375	2.250	0.750	35	57	19	29502-5687	IG	2.430	3.623	0.750	62	92	19
29502-5524	IG	6.218	8.062	0.750	158	205	19	29502-5689	IG	1.241	2.253	0.750	32	57	19
29502-5526	IG	1.171	2.250	0.750	30	57	19	29502-5692	IG	1.688	3.437	0.750	43	87	19
29502-5533	IG	2.047	3.150	0.750	52	80	19	29502-5697	IG	2.950	3.950	0.750	75	100	19
29502-5534	IG	0.984	1.890	0.750	25	48	19	29502-5701	IG	3.346	4.134	0.750	85	105	19
29502-5535	IG	2.362	3.111	0.750	60	79	19	29502-5702	IG	6.430	7.500	0.750	163	191	19
29502-5538	IG	2.160	3.160	0.750	55	80	19	29502-5705	IG	2.062	2.875	0.750	52	73	19
29502-5539	IG	1.575	2.362	0.750	40	60	19	29502-5706	IG	2.554	3.375	0.750	65	86	19
29502-5540	IG	1.654	2.441	0.750	42	62	19	29502-5707	IG	4.438	5.562	0.750	113	141	19
29502-5541	IG	1.772	2.559	0.750	45	65	19	29502-5712	IG	6.063	7.500	0.750	154	191	19
29502-5542	IG	2.165	3.071	0.750	55	78	19	29502-5713	IG	1.938	2.688	0.750	49	68	19
29502-5543	IG	2.362	3.150	0.750	60	80	19	29502-5716	IG	4.250	5.376	0.750	108	137	19
29502-5545	IG	2.205	3.150	0.750	56	80	19	29502-5717	IG	4.362	5.362	0.750	111	136	19
29502-5548	IG	4.331	5.562	0.750	110	141	19	29502-5718	IG	2.550	3.550	0.750	65	90	19
29502-5549	IG	5.591	6.378	0.750	142	162	19	29502-5719	IG	4.100	5.100	0.750	104	130	19
29502-5550	IG	4.724	5.512	0.750	120	140	19	29502-5721	IG	3.790	4.790	0.750	96	122	19
29502-5555	IG	6.000	7.059	0.750	152	179	19	29502-5723	IG	3.125	4.312	0.750	79	110	19

All dimensions are in inches. Preferred sizes are indicated with **bold** type face. Sizes listed are for standard nitrile elements, except Models 25 and 62 which have PTFE elements. Other material available on inquiry only.

Oil Seals by Model Number

Product Code	Model	Inches			MM			Product Code	Model	Inches			MM		
		ID	OD	Width	ID	OD	Width			ID	OD	Width	ID	OD	Width
29502-5729	IG	2.341	3.151	0.750	59	80	19	29502-5951	IG	0.670	1.850	0.750	17	47	19
29502-5730	IG	3.725	4.725	0.750	95	120	19	29502-5955	IG	9.842	10.593	0.750	250	269	19
29502-5731	IG	1.562	2.598	0.750	40	66	19	29502-5958	IG	2.820	3.837	0.750	72	97	19
29502-5734	IG	2.275	3.275	0.750	58	83	19	29502-5960	IG	1.575	2.165	0.750	40	55	19
29502-5735	IG	4.325	5.325	0.750	110	135	19	29502-5961	IG	1.932	2.875	0.750	49	73	19
29502-5739	IG	2.953	4.331	0.750	75	110	19	29502-5962	IG	3.543	4.528	0.750	90	115	19
29502-5742	IG	2.950	4.000	0.750	75	102	19	29502-5966	IG	3.938	5.000	0.750	100	127	19
29502-5743	IG	1.500	2.750	0.750	38	70	19	29502-5968	IG	1.438	2.727	0.750	37	69	19
29502-5745	IG	5.375	6.125	0.750	137	156	19	29502-5970	IG	2.756	3.780	0.750	70	96	19
29502-5746	IG	7.375	8.625	0.750	187	219	19	29502-5973	IG	4.527	5.527	0.750	115	140	19
29502-5748	IG	3.540	4.540	0.750	90	115	19	29502-5975	IG	3.313	4.250	0.750	84	108	19
29502-5749	IG	3.535	4.535	0.750	90	115	19	29502-5977	IG	1.750	3.924	0.750	44	100	19
29502-5751	IG	3.685	4.685	0.750	94	119	19	29502-5978	IG	2.345	3.345	0.750	60	85	19
29502-5753	IG	1.906	2.752	0.750	48	70	19	29502-5979	IG	2.813	3.751	0.750	71	95	19
29502-5754	IG	4.515	5.515	0.750	115	140	19	29502-5980	IG	4.313	5.875	0.750	110	149	19
29502-5755	IG	3.420	4.420	0.750	87	112	19	29502-5982	IG	2.500	3.600	0.750	64	91	19
29502-5757	IG	3.750	5.500	0.750	95	140	19	29502-5983	IG	4.000	4.990	0.750	102	127	19
29502-5759	IG	2.530	3.530	0.750	64	90	19	29502-5984	IG	3.312	4.061	0.750	84	103	19
29502-5760	IG	2.560	3.560	0.750	65	90	19	29502-5990	IG	2.700	3.700	0.750	69	94	19
29502-5761	IG	3.307	4.307	0.750	84	109	19	29502-5991	IG	6.000	7.125	0.750	152	181	19
29502-5762	IG	2.520	3.520	0.750	64	89	19	29502-5992	IG	7.500	8.750	0.750	191	222	19
29502-5763	IG	3.110	4.331	0.750	79	110	19	29502-5996	IG	4.216	5.750	0.750	107	146	19
29502-5766	IG	1.772	3.021	0.750	45	77	19	29502-5998	IG	2.740	3.740	0.750	70	95	19
29502-5767	IG	4.331	5.125	0.750	110	130	19	29502-6002	IG	2.344	3.250	0.750	60	83	19
29502-5769	IG	2.125	3.500	0.750	54	89	19	29502-6003	IG	2.750	3.755	0.750	70	95	19
29502-5772	IG	2.625	3.750	0.750	67	95	19	29502-6009	IG	2.386	4.250	0.750	61	108	19
29502-5773	IG	2.677	4.000	0.750	68	102	19	29502-6017	IG	3.147	4.147	0.750	80	105	19
29502-5774	IG	5.635	6.874	0.750	143	175	19	29502-6020	IG	3.750	5.125	0.750	95	130	19
29502-5775	IG	1.375	3.150	0.750	35	80	19	29502-6021	IG	2.283	3.150	0.750	58	80	19
29502-5778	IG	2.500	4.875	0.750	64	124	19	29502-6022	IG	2.438	3.287	0.750	62	83	19
29502-5793	IG	2.500	3.625	0.750	64	92	19	29502-6023	IG	3.875	5.000	0.750	98	127	19
29502-5794	IG	0.866	1.969	0.750	22	50	19	29502-6024	IG	1.250	2.125	0.750	32	54	19
29502-5795	IG	2.559	3.583	0.750	65	91	19	29502-6027	IG	3.150	4.530	0.750	80	115	19
29502-5798	IG	1.378	2.835	0.750	35	72	19	29502-6034	IG	8.661	9.842	0.750	220	250	19
29502-5801	IG	2.335	3.335	0.750	59	85	19	29502-6035	IG	3.938	4.985	0.750	100	127	19
29502-5803	IG	2.559	4.724	0.750	65	120	19	29502-6036	IG	4.438	5.890	0.750	113	150	19
29502-5807	IG	1.772	3.543	0.750	45	90	19	29502-6037	IG	4.438	5.906	0.750	113	150	19
29502-5810	IG	6.498	9.125	0.750	165	232	19	29502-6038	IG	2.500	3.313	0.750	64	84	19
29502-5813	IG	4.488	5.512	0.750	114	140	19	29502-6039	IG	2.240	2.994	0.750	57	76	19
29502-5815	IG	2.625	5.250	0.750	67	133	19	29502-6043	IG	1.938	3.125	0.750	49	79	19
29502-5816	IG	3.250	5.250	0.750	83	133	19	29502-6045	IG	1.475	2.430	0.750	37	62	19
29502-5818	IG	2.312	3.750	0.750	59	95	19	29502-6051	IG	2.563	3.500	0.750	65	89	19
29502-5819	IG	1.772	3.346	0.750	45	85	19	29502-6056	IG	4.313	5.375	0.750	110	137	19
29502-5820	IG	2.250	3.500	0.750	57	89	19	29502-6058	IG	1.950	3.250	0.750	50	83	19
29502-5821	IG	4.375	5.312	0.750	111	135	19	29502-6063	IG	1.688	2.438	0.750	43	62	19
29502-5825	IG	2.300	3.300	0.750	58	84	19	29502-6068	IG	3.188	4.125	0.750	81	105	19
29502-5912	IG	4.375	6.000	0.750	111	152	19	29502-6069	IG	1.811	2.835	0.750	46	72	19
29502-5930	IG	1.772	2.835	0.750	45	72	19	29502-6070	IG	1.732	2.756	0.750	44	70	19
29502-5931	IG	2.283	4.409	0.750	58	112	19	29502-6071	IG	3.000	4.250	0.750	76	108	19
29502-5933	IG	3.500	4.721	0.750	89	120	19	29502-6072	IG	1.250	2.839	0.750	32	72	19
29502-5934	IG	1.575	2.325	0.750	40	59	19	29502-6073	IG	1.750	3.563	0.750	44	91	19
29502-5940	IG	4.528	5.709	0.750	115	145	19	29502-6074	IG	6.890	8.366	0.750	175	212	19
29502-5941	IG	3.465	5.512	0.750	88	140	19	29502-6075	IG	3.563	4.750	0.750	91	121	19
29502-5943	IG	2.930	3.930	0.750	74	100	19	29502-6081	IG	1.750	2.850	0.750	44	72	19
29502-5947	IG	1.250	2.500	0.750	32	64	19	29502-6085	IG	6.299	7.313	0.750	160	186	19
29502-5950	IG	0.984	1.875	0.750	25	48	19	29502-6090	IG	3.500	5.125	0.750	89	130	19

All dimensions are in inches. Preferred sizes are indicated with **bold** type face. Sizes listed are for standard nitrile elements, except Models 25 and 62 which have PTFE elements. Other material available on inquiry only.



## Oil Seals by Model Number

Product Code	Model	Inches			MM			Product Code	Model	Inches			MM		
		ID	OD	Width	ID	OD	Width			ID	OD	Width	ID	OD	Width
29502-6094	IG	6.998	8.003	0.750	178	203	19	29502-6309	IG	2.620	3.500	0.750	67	89	19
29502-6095	IG	7.998	9.013	0.750	203	229	19	29502-6320	IG	3.312	4.437	0.750	84	113	19
29502-6102	IG	1.781	3.546	0.750	45	90	19	29502-6323	IG	3.465	4.331	0.750	88	110	19
29502-6103	IG	1.563	2.875	0.750	40	73	19	29502-6324	IG	5.314	6.299	0.750	135	160	19
29502-6109	IG	6.625	7.875	0.750	168	200	19	29502-6325	IG	3.740	4.490	0.750	95	114	19
29502-6110	IG	7.438	8.438	0.750	189	214	19	29502-6326	IG	3.250	4.750	0.750	83	121	19
29502-6111	IG	2.688	4.000	0.750	68	102	19	29502-6329	IG	5.039	5.906	0.750	128	150	19
29502-6119	IG	3.750	4.875	0.750	95	124	19	29502-6330	IG	3.931	5.125	0.750	100	130	19
29502-6128	IG	6.938	8.250	0.750	176	210	19	29502-6331	IG	3.812	5.125	0.750	97	130	19
29502-6131	IG	3.375	4.250	0.750	86	108	19	29502-6332	IG	1.875	3.188	0.750	48	81	19
29502-6136	IG	1.102	1.890	0.750	28	48	19	29502-6337	IG	3.813	5.000	0.750	97	127	19
29502-6137	IG	1.875	3.543	0.750	48	90	19	29502-6339	IG	1.772	2.795	0.750	45	71	19
29502-6141	IG	2.500	3.375	0.750	64	86	19	29502-6349	IG	4.684	6.000	0.750	119	152	19
29502-6144	IG	2.375	3.625	0.750	60	92	19	29502-6350	IG	1.938	2.969	0.750	49	75	19
29502-6145	IG	3.000	4.003	0.750	76	102	19	29502-6351	IG	2.500	3.938	0.750	64	100	19
29502-6150	IG	3.625	4.500	0.750	92	114	19	29502-6353	IG	5.118	5.906	0.748	130	150	19
29502-6151	IG	2.563	3.750	0.750	65	95	19	29502-6392	IG	3.438	4.250	0.750	87	108	19
29502-6154	IG	5.500	7.125	0.750	140	181	19	29502-6393	IG	3.307	4.350	0.750	84	110	19
29502-6155	IG	1.563	2.686	0.750	40	68	19	29502-6394	IG	1.142	2.142	0.750	29	54	19
29502-6162	IG	1.965	3.543	0.750	50	90	19	29502-6396	IG	1.338	2.375	0.750	34	60	19
29502-6167	IG	2.125	3.060	0.750	54	78	19	29502-6404	IG	4.093	5.375	0.750	104	137	19
29502-6168	IG	1.969	2.835	0.750	50	72	19	29502-6406	IG	4.750	6.250	0.750	121	159	19
29502-6171	IG	3.920	4.920	0.750	100	125	19	29502-6408	IG	3.500	4.750	0.750	89	121	19
29502-6176	IG	1.772	3.887	0.750	45	99	19	29502-6410	IG	1.625	3.500	0.750	41	89	19
29502-6179	IG	2.000	2.900	0.750	51	74	19	29502-6415	IG	2.756	3.622	0.750	70	92	19
29502-6181	IG	2.000	3.500	0.750	51	89	19	29502-6419	IG	2.165	3.250	0.750	55	83	19
29502-6183	IG	4.030	4.960	0.750	102	126	19	29502-6420	IG	4.562	5.500	0.750	116	140	19
29502-6188	IG	2.585	4.000	0.750	66	102	19	29502-6421	IG	1.375	2.960	0.750	35	75	19
29502-6191	IG	2.825	3.815	0.750	72	97	19	29502-6423	IG	3.188	4.375	0.750	81	111	19
29502-6192	IG	2.500	3.256	0.750	64	83	19	29502-6428	IG	4.720	6.000	0.750	120	152	19
29502-6196	IG	1.969	2.960	0.750	50	75	19	29502-6429	IG	4.681	5.587	0.750	119	142	19
29502-6197	IG	2.760	4.000	0.750	70	102	19	29502-6430	IG	3.776	4.777	0.750	96	121	19
29502-6199	IG	2.438	4.375	0.750	62	111	19	29502-6431	IG	3.150	4.175	0.750	80	106	19
29502-6200	IG	1.625	2.750	0.750	41	70	19	29502-6440	IG	4.921	6.181	0.750	125	157	19
29502-6201	IG	3.185	4.185	0.750	81	106	19	29502-6441	IG	4.182	5.182	0.750	106	132	19
29502-6210	IG	2.047	3.000	0.750	52	76	19	29502-6442	IG	1.181	2.165	0.750	30	55	19
29502-6211	IG	4.562	5.750	0.750	116	146	19	29502-6443	IG	1.945	2.756	0.750	49	70	19
29502-6212	IG	2.435	3.435	0.750	62	87	19	29502-6449	IG	3.375	4.875	0.750	86	124	19
29502-6213	IG	3.543	4.575	0.750	90	116	19	29502-6456	IG	3.750	4.500	0.750	95	114	19
29502-6223	IG	3.875	4.625	0.750	98	117	19	29502-6457	IG	2.559	3.465	0.750	65	88	19
29502-6225	IG	1.181	2.205	0.750	30	56	19	29502-6463	IG	4.312	6.250	0.750	110	159	19
29502-6228	IG	2.283	4.331	0.750	58	110	19	29502-6464	IG	3.565	4.565	0.750	91	116	19
29502-6231	IG	2.363	3.150	0.750	60	80	19	29502-6465	IG	2.500	3.275	0.750	64	83	19
29502-6239	IG	3.442	4.375	0.750	87	111	19	29502-6466	IG	4.327	5.562	0.750	110	141	19
29502-6247	IG	2.519	3.318	0.750	64	84	19	29502-6470	IG	8.661	11.000	0.750	220	279	19
29502-6250	IG	1.763	2.960	0.750	45	75	19	29502-6476	IG	2.677	3.740	0.750	68	95	19
29502-6262	IG	2.244	3.043	0.750	57	77	19	29502-6481	IG	2.156	4.725	0.750	55	120	19
29502-6275	IG	2.360	3.149	0.750	60	80	19	29502-6485	IG	2.362	4.409	0.750	60	112	19
29502-6295	IG	1.375	2.875	0.750	35	73	19	29502-6486	IG	1.772	3.327	0.750	45	85	19
29502-6298	IG	3.375	5.285	0.750	86	134	19	29502-6487	IG	3.536	5.375	0.750	90	137	19
29502-6302	IG	3.622	4.724	0.750	92	120	19	29502-6490	IG	1.180	2.250	0.750	30	57	19
29502-6303	IG	2.047	2.835	0.750	52	72	19	29502-6492	IG	3.346	4.488	0.750	85	114	19
29502-6304	IG	1.654	2.835	0.750	42	72	19	29502-6493	IG	3.543	4.567	0.750	90	116	19
29502-6305	IG	2.000	2.775	0.750	51	70	19	29502-6494	IG	4.350	5.350	0.750	110	136	19
29502-6306	IG	3.562	4.481	0.750	90	114	19	29502-6495	IG	3.545	4.565	0.750	90	116	19
29502-6308	IG	2.750	4.250	0.750	70	108	19	29502-6500	IG	2.500	4.440	0.750	64	113	19

All dimensions are in inches. Preferred sizes are indicated with **bold** type face.

Sizes listed are for standard nitrile elements, except Models 25 and 62 which have PTFE elements. Other material available on inquiry only.



## Oil Seals by Model Number

Product Code	Model	Inches			MM			Product Code	Model	Inches			MM		
		ID	OD	Width	ID	OD	Width			ID	OD	Width	ID	OD	Width
29505-0646	IG	2.562	3.562	0.500	65	90	13	29507-2182	IG	0.875	1.375	0.625	22	35	16
29505-0707	IG	1.750	2.500	0.500	44	64	13	29507-2222	IG	3.125	4.000	0.625	79	102	16
29505-1395	IG	1.125	2.000	0.500	29	51	13	29507-2240	IG	3.150	3.937	0.625	80	100	16
29505-4461	IG	3.250	4.999	0.625	83	127	16	29507-2272	IG	3.150	4.134	0.625	80	105	16
29505-4817	IG	3.938	4.938	0.500	100	125	13	29507-2273	IG	1.125	1.625	0.625	29	41	16
29505-5764	IG	1.180	2.180	0.500	30	55	13	29507-2278	IG	3.250	4.500	0.625	83	114	16
29505-5765	IG	2.161	3.161	0.500	55	80	13	29507-2322	IG	3.375	4.375	0.625	86	111	16
29505-5786	IG	0.983	1.983	0.500	25	50	13	29507-2405	IG	3.543	4.543	0.625	90	115	16
29505-5787	IG	1.573	2.572	0.500	40	65	13	29507-2604	IG	4.125	5.125	0.625	105	130	16
29505-5788	IG	1.754	2.754	0.500	45	70	13	29507-2659	IG	4.250	5.250	0.625	108	133	16
29505-5789	IG	1.967	2.967	0.500	50	75	13	29507-2684	IG	1.000	1.500	0.625	25	38	16
29505-5790	IG	2.562	3.564	0.500	65	91	13	29507-2711	IG	0.875	1.875	0.625	22	48	16
29505-5791	IG	3.158	4.158	0.500	80	106	13	29507-2714	IG	0.938	1.938	0.625	24	49	16
29505-5937	IG	2.000	3.375	0.625	51	86	16	29507-2720	IG	1.438	2.438	0.625	37	62	16
29505-6084	IG	2.820	3.820	0.500	72	97	13	29507-2722	IG	1.563	2.563	0.625	40	65	16
29505-6715	IG	1.781	3.543	0.500	45	90	13	29507-2755	IG	4.500	5.500	0.625	114	140	16
29507-0706	IG	1.875	3.000	0.625	48	76	16	29507-2808	IG	4.625	5.625	0.625	117	143	16
29507-0988	IG	1.125	2.000	0.625	29	51	16	29507-2940	IG	1.375	2.000	0.625	35	51	16
29507-0989	IG	1.875	2.625	0.625	48	67	16	29507-2971	IG	1.571	2.571	0.625	40	65	16
29507-0991	IG	2.500	3.250	0.625	64	83	16	29507-3029	IG	1.562	2.500	0.625	40	64	16
29507-0998	IG	1.750	2.875	0.625	44	73	16	29507-3052	IG	2.160	3.160	0.625	55	80	16
29507-1026	IG	1.750	2.500	0.625	44	64	16	29507-3107	IG	2.755	3.741	0.625	70	95	16
29507-1062	IG	1.750	2.625	0.625	44	67	16	29507-3170	IG	2.560	3.560	0.625	65	90	16
29507-1075	IG	1.875	2.750	0.625	48	70	16	29507-3266	IG	1.967	2.967	0.625	50	75	16
29507-1089	IG	1.625	2.625	0.625	41	67	16	29507-3316	IG	2.953	3.740	0.625	75	95	16
29507-1090	IG	0.875	1.750	0.625	22	44	16	29507-3388	IG	1.181	2.181	0.625	30	55	16
29507-1092	IG	1.375	2.125	0.625	35	54	16	29507-3398	IG	1.000	1.750	0.625	25	44	16
29507-1118	IG	1.500	2.125	0.625	38	54	16	29507-3492	IG	7.000	8.000	0.625	178	203	16
29507-1119	IG	2.188	3.000	0.625	56	76	16	29507-3534	IG	1.250	1.687	0.625	32	43	16
29507-1144	IG	3.938	4.938	0.625	100	125	16	29507-4106	IG	0.875	1.250	0.625	22	32	16
29507-1146	IG	1.312	2.000	0.625	33	51	16	29507-4121	IG	1.062	1.625	0.625	27	41	16
29507-1152	IG	1.125	1.876	0.625	29	48	16	29507-4122	IG	0.938	1.500	0.625	24	38	16
29507-1194	IG	1.500	2.500	0.625	38	64	16	29507-4123	IG	0.875	1.625	0.625	22	41	16
29507-1214	IG	1.500	2.375	0.625	38	60	16	29507-4130	IG	1.500	2.000	0.625	38	51	16
29507-1215	IG	1.250	2.000	0.625	32	51	16	29507-4176	IG	1.375	1.875	0.625	35	48	16
29507-1221	IG	1.181	1.556	0.625	30	40	16	29507-4183	IG	1.750	2.375	0.625	44	60	16
29507-1238	IG	2.750	3.500	0.625	70	89	16	29507-4184	IG	1.125	1.750	0.625	29	44	16
29507-1249	IG	2.000	2.750	0.625	51	70	16	29507-4206	IG	1.062	1.643	0.625	27	42	16
29507-1251	IG	2.562	3.562	0.625	65	90	16	29507-4317	IG	0.625	1.250	0.625	16	32	16
29507-1252	IG	2.500	3.623	0.625	64	92	16	29507-4318	IG	1.375	2.063	0.625	35	52	16
29507-1322	IG	2.125	2.875	0.625	54	73	16	29507-4333	IG	1.060	1.625	0.625	27	41	16
29507-1323	IG	2.125	3.000	0.625	54	76	16	29507-4334	IG	1.125	1.563	0.625	29	40	16
29507-1348	IG	2.362	3.150	0.625	60	80	16	29507-4337	IG	2.155	2.875	0.625	55	73	16
29507-1350	IG	2.000	3.000	0.625	51	76	16	29507-4339	IG	0.875	1.500	0.625	22	38	16
29507-1406	IG	2.000	2.875	0.625	51	73	16	29507-4340	IG	1.250	1.750	0.625	32	44	16
29507-1581	IG	2.375	3.250	0.625	60	83	16	29507-4414	IG	1.813	2.313	0.625	46	59	16
29507-1645	IG	2.375	3.125	0.625	60	79	16	29507-4456	IG	1.438	2.125	0.625	37	54	16
29507-1744	IG	1.750	2.750	0.625	44	70	16	29507-4484	IG	2.676	3.362	0.625	68	85	16
29507-1818	IG	2.500	3.500	0.625	64	89	16	29507-4522	IG	2.938	3.623	0.625	75	92	16
29507-1901	IG	2.250	3.189	0.625	57	81	16	29507-4533	IG	0.938	2.048	0.625	24	52	16
29507-1942	IG	2.438	3.250	0.625	62	83	16	29507-4539	IG	2.000	2.625	0.625	51	67	16
29507-1958	IG	1.438	2.375	0.625	37	60	16	29507-4545	IG	1.570	2.250	0.625	40	57	16
29507-1962	IG	2.625	3.375	0.625	67	86	16	29507-4547	IG	2.375	3.063	0.625	60	78	16
29507-2005	IG	2.165	3.150	0.625	55	80	16	29507-4551	IG	0.750	1.875	0.625	19	48	16
29507-2016	IG	2.500	3.189	0.625	64	81	16	29507-4554	IG	1.772	2.165	0.625	45	55	16
29507-2059	IG	2.756	3.543	0.625	70	90	16	29507-4563	IG	0.984	1.850	0.625	25	47	16

All dimensions are in inches. Preferred sizes are indicated with **bold** type face. Sizes listed are for standard nitrile elements, except Models 25 and 62 which have PTFE elements. Other material available on inquiry only.

## Oil Seals by Model Number

Product Code	Model	Inches			MM			Product Code	Model	Inches			MM		
		ID	OD	Width	ID	OD	Width			ID	OD	Width	ID	OD	Width
29507-4564	IG	2.875	3.500	0.625	73	89	16	29507-5138	IG	1.766	2.323	0.625	45	59	16
29507-4586	IG	1.750	2.250	0.625	44	57	16	29507-5139	IG	2.441	2.992	0.625	62	76	16
29507-4613	IG	1.771	2.559	0.625	45	65	16	29507-5151	IG	2.000	2.712	0.625	51	69	16
29507-4637	IG	0.625	1.300	0.625	16	33	16	29507-5153	IG	2.938	3.544	0.625	75	90	16
29507-4667	IG	2.149	2.875	0.625	55	73	16	29507-5171	IG	0.983	1.983	0.625	25	50	16
29507-4711	IG	1.063	1.875	0.625	27	48	16	29507-5199	IG	2.185	3.189	0.625	55	81	16
29507-4718	IG	1.575	2.047	0.625	40	52	16	29507-5201	IG	1.745	2.745	0.625	44	70	16
29507-4724	IG	0.688	1.125	0.625	17	29	16	29507-5204	IG	1.181	1.772	0.625	30	45	16
29507-4793	IG	2.750	3.250	0.625	70	83	16	29507-5205	IG	0.984	1.486	0.625	25	38	16
29507-4815	IG	1.375	2.103	0.625	35	53	16	29507-5207	IG	1.125	1.500	0.625	29	38	16
29507-4839	IG	2.145	2.871	0.625	54	73	16	29507-5217	IG	1.754	2.754	0.625	45	70	16
29507-4840	IG	1.125	1.855	0.625	29	47	16	29507-5218	IG	3.158	4.158	0.625	80	106	16
29507-4864	IG	1.732	2.250	0.625	44	57	16	29507-5225	IG	1.726	2.250	0.625	44	57	16
29507-4868	IG	0.787	1.378	0.625	20	35	16	29507-5265	IG	2.375	3.000	0.625	60	76	16
29507-4889	IG	1.936	2.367	0.625	49	60	16	29507-5266	IG	4.331	4.961	0.625	110	126	16
29507-4890	IG	2.437	2.930	0.625	62	74	16	29507-5270	IG	1.889	2.874	0.625	48	73	16
29507-4893	IG	3.500	4.125	0.625	89	105	16	29507-5282	IG	0.750	1.750	0.625	19	44	16
29507-4900	IG	0.866	1.260	0.626	22	32	16	29507-5283	IG	0.750	1.125	0.625	19	29	16
29507-4909	IG	0.984	1.575	0.625	25	40	16	29507-5290	IG	1.625	2.250	0.625	41	57	16
29507-4918	IG	1.181	1.575	0.625	30	40	16	29507-5291	IG	1.773	2.500	0.625	45	64	16
29507-4919	IG	1.181	1.850	0.625	30	47	16	29507-5295	IG	2.147	2.875	0.625	55	73	16
29507-4920	IG	1.181	1.654	0.625	30	42	16	29507-5308	IG	1.813	2.750	0.625	46	70	16
29507-4922	IG	1.260	1.850	0.625	32	47	16	29507-5316	IG	2.490	2.875	0.625	63	73	16
29507-4924	IG	1.378	1.850	0.625	35	47	16	29507-5318	IG	1.998	2.500	0.625	51	64	16
29507-4925	IG	1.378	1.969	0.625	35	50	16	29507-5319	IG	1.750	2.312	0.625	44	59	16
29507-4926	IG	1.378	2.047	0.625	35	52	16	29507-5322	IG	0.781	1.375	0.625	20	35	16
29507-4934	IG	1.496	2.165	0.625	38	55	16	29507-5325	IG	0.787	1.654	0.625	20	42	16
29507-4937	IG	1.575	2.165	0.625	40	55	16	29507-5326	IG	4.646	5.036	0.625	118	128	16
29507-4938	IG	1.654	2.165	0.625	42	55	16	29507-5360	IG	1.625	2.125	0.625	41	54	16
29507-4939	IG	1.772	2.362	0.625	45	60	16	29507-5363	IG	1.878	2.754	0.625	48	70	16
29507-4940	IG	1.772	2.441	0.625	45	62	16	29507-5373	IG	1.500	2.219	0.625	38	56	16
29507-4943	IG	1.890	2.835	0.625	48	72	16	29507-5384	IG	0.750	1.378	0.625	19	35	16
29507-4944	IG	1.969	2.559	0.625	50	65	16	29507-5394	IG	1.125	1.875	0.625	29	48	16
29507-4945	IG	1.969	2.677	0.625	50	68	16	29507-5401	IG	1.750	2.437	0.625	44	62	16
29507-4948	IG	2.047	2.677	0.625	52	68	16	29507-5406	IG	2.438	2.813	0.625	62	71	16
29507-4951	IG	2.165	2.756	0.625	55	70	16	29507-5408	IG	1.688	2.506	0.625	43	64	16
29507-4952	IG	2.166	2.835	0.625	55	72	16	29507-5412	IG	1.000	1.687	0.625	25	43	16
29507-4953	IG	2.205	2.756	0.625	56	70	16	29507-5416	IG	0.669	1.575	0.625	17	40	16
29507-5004	IG	2.955	3.500	0.625	75	89	16	29507-5435	IG	0.906	1.500	0.625	23	38	16
29507-5006	IG	4.130	4.505	0.625	105	114	16	29507-5478	IG	2.148	2.875	0.625	55	73	16
29507-5012	IG	2.188	2.832	0.625	56	72	16	29507-5482	IG	1.570	2.000	0.625	40	51	16
29507-5013	IG	2.543	3.543	0.625	65	90	16	29507-5502	IG	2.000	2.500	0.625	51	64	16
29507-5014	IG	2.746	3.746	0.625	70	95	16	29507-5518	IG	1.880	2.625	0.625	48	67	16
29507-5016	IG	2.556	3.556	0.625	65	90	16	29507-5519	IG	1.685	3.185	0.625	43	81	16
29507-5017	IG	2.312	3.000	0.625	59	76	16	29507-5536	IG	1.260	1.654	0.625	32	42	16
29507-5062	IG	2.875	3.375	0.625	73	86	16	29507-5544	IG	2.559	3.228	0.625	65	82	16
29507-5063	IG	2.375	2.938	0.625	60	75	16	29507-5547	IG	1.938	2.412	0.625	49	61	16
29507-5068	IG	1.575	2.283	0.625	40	58	16	29507-5552	IG	1.417	2.125	0.625	36	54	16
29507-5093	IG	2.200	2.750	0.625	56	70	16	29507-5554	IG	1.969	2.690	0.625	50	68	16
29507-5097	IG	1.375	2.263	0.625	35	57	16	29507-5562	IG	0.750	1.500	0.625	19	38	16
29507-5098	IG	2.125	3.129	0.625	54	79	16	29507-5563	IG	4.938	5.500	0.625	125	140	16
29507-5112	IG	1.156	1.875	0.625	29	48	16	29507-5564	IG	2.250	2.875	0.625	57	73	16
29507-5126	IG	2.362	3.308	0.625	60	84	16	29507-5576	IG	1.375	1.750	0.625	35	44	16
29507-5129	IG	1.938	2.623	0.625	49	67	16	29507-5586	IG	0.984	1.929	0.625	25	49	16
29507-5136	IG	3.188	3.688	0.625	81	94	16	29507-5624	IG	1.438	1.938	0.625	37	49	16
29507-5137	IG	4.000	4.500	0.625	102	114	16	29507-5649	IG	2.500	3.000	0.625	64	76	16

All dimensions are in inches. Preferred sizes are indicated with **bold** type face.  
 Sizes listed are for standard nitrile elements, except Models 25 and 62 which have PTFE elements. Other material available on inquiry only.











## Oil Seals by Model Number

Product Code	Model	Inches			MM			Product Code	Model	Inches			MM		
		ID	OD	Width	ID	OD	Width			ID	OD	Width	ID	OD	Width
29520-4326	IG	2.000	2.750	0.750	51	70	19	29522-4173	IG	5.625	6.625	0.750	143	168	19
29520-4331	IG	2.875	4.000	0.750	73	102	19	29522-4174	IG	5.750	6.750	0.750	146	171	19
29520-4353	IG	2.500	4.375	0.750	64	111	19	29522-4283	IG	2.812	3.812	0.750	71	97	19
29520-4709	IG	3.000	3.750	0.750	76	95	19	29522-4284	IG	2.938	3.938	0.750	75	100	19
29520-4721	IG	2.559	3.543	0.750	65	90	19	29522-4287	IG	3.313	4.313	0.750	84	110	19
29520-4819	IG	1.969	2.756	0.750	50	70	19	29522-4295	IG	4.188	5.188	0.750	106	132	19
29520-4969	IG	2.756	3.543	0.750	70	90	19	29522-4300	IG	4.938	5.938	0.750	125	151	19
29520-4983	IG	4.331	5.118	0.750	110	130	19	29522-4310	IG	6.125	7.125	0.750	156	181	19
29520-5005	IG	2.750	3.720	0.750	70	94	19	29522-4316	IG	6.500	7.500	0.750	165	191	19
29520-5539	IG	1.575	2.362	0.750	40	60	19	29524-4798	IG	3.150	3.937	0.750	80	100	19
29520-5541	IG	1.772	2.559	0.750	45	65	19	29524-4980	IG	3.937	4.724	0.750	100	120	19
29520-5654	IG	2.134	3.066	0.750	54	78	19	29524-5539	IG	1.575	2.362	0.750	40	60	19
29520-5660	IG	1.875	3.500	0.750	48	89	19	29524-5766	IG	1.772	3.021	0.750	45	77	19
29520-5769	IG	2.125	3.500	0.750	54	89	19	29524-5822	IG	1.969	3.189	0.750	50	81	19
29520-5950	IG	0.984	1.875	0.750	25	48	19	29525-5948	IG	5.900	6.900	0.750	150	175	19
29520-6050	IG	3.000	4.160	0.750	76	106	19	29526-4108	IG	1.125	2.000	0.750	29	51	19
29520-6168	IG	1.969	2.835	0.750	50	72	19	29526-4124	IG	1.875	2.625	0.750	48	67	19
29520-6169	IG	1.850	2.835	0.750	47	72	19	29529-3349	IG	2.000	3.000	0.750	51	76	19
29520-6202	IG	4.562	6.187	0.750	116	157	19	29529-3585	IG	1.875	2.875	0.750	48	73	19
29520-6316	IG	1.182	1.932	0.750	30	49	19	29529-4146	IG	2.125	3.125	0.750	54	79	19
29520-6340	IG	3.750	5.750	0.750	95	146	19	29529-4148	IG	2.250	3.250	0.750	57	83	19
29520-6453	IG	2.750	4.750	0.750	70	121	19	29529-4153	IG	2.875	3.875	0.750	73	98	19
29520-6454	IG	2.375	4.500	0.750	60	114	19	29529-7284	IG	4.559	6.250	0.750	116	159	19
29520-6510	IG	2.283	3.307	0.750	58	84	19	29529-7285	IG	4.125	5.000	0.750	105	127	19
29520-6622	IG	1.891	2.896	0.750	48	74	19	29531-3817	IG	8.250	9.250	0.625	210	235	16
29520-6732	IG	2.688	3.500	0.750	68	89	19	29598-0002	IG	2.438	3.188	0.976	62	81	25
29520-6910	IG	1.575	2.500	0.750	40	64	19	29598-0003	IG	2.688	3.563	0.976	68	91	25
29520-7275	IG	2.953	3.967	0.760	75	101	19	29598-0010	IG	3.438	4.460	0.994	87	113	25
29520-7423	IG	0.875	1.750	0.760	22	44	19								
29521-5733	IG	3.000	4.250	0.875	76	108	22								
29521-5799	IG	2.375	3.125	0.875	60	79	22								
29521-5805	IG	2.750	3.875	0.875	70	98	22								
29521-5954	IG	3.427	4.999	0.875	87	127	22								
29521-5957	IG	1.500	2.500	0.875	38	64	22								
29521-5976	IG	3.346	4.346	0.875	85	110	22								
29521-6014	IG	5.000	6.000	0.875	127	152	22								
29521-6046	IG	3.250	5.000	0.875	83	127	22								
29521-6087	IG	1.710	3.000	0.875	43	76	22								
29521-6093	IG	7.000	8.500	0.875	178	216	22								
29521-6108	IG	2.750	3.813	0.875	70	97	22								
29521-6146	IG	0.625	1.375	0.875	16	35	22								
29521-6286	IG	1.500	2.250	0.875	38	57	22								
29521-6403	IG	3.750	5.000	0.875	95	127	22								
29521-6451	IG	4.000	5.000	0.875	102	127	22								
29521-6540	IG	4.500	5.500	0.875	114	140	22								
29521-6545	IG	4.724	5.906	0.875	120	150	22								
29521-6575	IG	6.693	7.874	0.875	170	200	22								
29521-6663	IG	4.134	5.118	0.875	105	130	22								
29522-2051	IG	4.563	5.563	0.750	116	141	19								
29522-2175	IG	3.000	4.000	0.750	76	102	19								
29522-3362	IG	6.000	7.000	0.750	152	178	19								
29522-4151	IG	2.625	3.625	0.750	67	92	19								
29522-4156	IG	3.500	4.500	0.750	89	114	19								
29522-4160	IG	4.000	5.000	0.750	102	127	19								
29522-4163	IG	4.250	5.250	0.750	108	133	19								
29522-4171	IG	5.250	6.250	0.750	133	159	19								

All dimensions are in inches. Preferred sizes are indicated with **bold** type face.

Sizes listed are for standard nitrile elements, except Models 25 and 62 which have PTFE elements. Other material available on inquiry only.

## Face Seals by Model Number

Product Code	Model	Inches		MM		Product Code	Model	Inches		MM	
		From ID	To ID	From ID	To ID			From ID	To ID	From ID	To ID
21700-0350	145A1	12.953	13.130	329	334	21700-0900	145A1	35.120	35.910	892	912
21700-0360	145A1	14.170	14.300	360	363	21700-0930	145A1	36.300	36.730	922	933
21700-0390	145A1	15.350	15.500	390	394	21700-0940	145A1	36.730	37.170	933	944
21700-0400	145A1	16.000	16.200	406	411	21700-0950	145A1	37.170	37.600	944	955
21700-0410	145A1	16.000	16.142	406	410	21700-0980	145A1	38.470	38.900	977	988
21700-0425	145A1	15.866	16.056	403	408	21700-0990	145A1	38.900	39.330	988	999
21700-0430	145A1	16.900	17.100	429	434	21700-1000	145A1	39.330	39.760	999	1010
21700-0435	145A1	17.000	17.125	432	435	21700-1020	145A1	39.760	40.350	1010	1025
21700-0445	145A1	17.520	17.710	445	450	21700-1040	145A1	40.350	41.140	1025	1045
21700-0450	145A1	17.720	17.910	450	455	21700-1060	145A1	41.140	41.930	1045	1065
21700-0455	145A1	17.910	18.110	455	460	21700-1080	145A1	41.930	42.720	1065	1085
21700-0460	145A1	18.110	18.310	460	465	21700-1100	145A1	42.720	43.500	1085	1105
21700-0465	145A1	18.310	18.500	465	470	21700-1120	145A1	43.500	44.290	1105	1125
21700-0470	145A1	18.500	18.700	470	475	21700-1160	145A1	45.080	45.870	1145	1165
21700-0475	145A1	18.700	18.900	475	480	21700-1180	145A1	45.870	46.650	1165	1185
21700-0480	145A1	18.900	19.090	480	485	21700-1200	145A1	46.650	47.440	1185	1205
21700-0485	145A1	19.090	19.290	485	490	21700-1220	145A1	47.440	48.230	1205	1225
21700-0495	145A1	19.490	19.690	495	500	21700-1240	145A1	48.230	49.020	1225	1245
21700-0500	145A1	19.690	19.880	500	505	21700-1260	145A1	49.020	50.000	1245	1270
21700-0505	145A1	19.880	20.080	505	510	21700-1280	145A1	50.000	50.980	1270	1295
21700-0510	145A1	20.080	20.280	510	515	21700-1300	145A1	50.980	51.770	1295	1315
21700-0515	145A1	20.280	20.470	515	520	21700-1325	145A1	51.770	52.760	1315	1340
21700-0520	145A1	20.470	20.670	520	525	21700-1350	145A1	52.760	53.740	1340	1365
21700-0525	145A1	20.670	20.870	525	530	21700-1425	145A1	55.710	56.690	1415	1440
21700-0530	145A1	20.870	21.060	530	535	21700-1525	145A1	59.650	60.630	1515	1540
21700-0540	145A1	21.260	21.460	540	545	21700-1575	145A1	61.810	62.990	1570	1600
21700-0545	145A1	21.460	21.650	545	550	21700-1750	145A1	67.720	69.409	1720	1763
21700-0550	145A1	21.650	21.850	550	555	21700-1800	145A1	69.490	71.260	1765	1810
21700-0555	145A1	21.850	22.440	555	570	21700-1850	145A1	71.260	73.030	1810	1855
21700-0560	145A1	22.050	22.240	560	565	21700-1900	145A1	73.030	75.000	1855	1905
21700-0570	145A1	22.440	22.640	570	575	21700-2000	145A1	76.970	79.130	1955	2010
21700-0575	145A1	22.640	22.840	575	580	21700-2200	145A1	85.010	87.000	2159	2210
21700-0580	145A1	22.840	23.030	580	585	21700-2250	145A1	87.010	89.000	2210	2261
21700-0585	145A1	23.030	23.230	585	590	21700-2650	145A1	103.010	105.000	2616	2667
21700-0600	145A1	23.260	24.020	591	610	21700-3200	145A1	125.010	127.000	3175	3226
21700-0610	145A1	24.020	24.410	610	620	21700-3250	145A1	127.010	129.000	3226	3277
21700-0620	145A1	24.410	24.800	620	630	21700-3300	145A1	129.010	131.000	3277	3327
21700-0630	145A1	24.800	25.200	630	640	21700-4350	145A1	171.000	173.000	4343	4394
21700-0650	145A1	25.580	25.980	650	660	21712-0390	145A1	15.350	15.550	390	395
21700-0660	145A1	25.980	26.380	660	670	21712-0600	145A1	22.830	24.800	580	630
21700-0670	145A1	26.380	26.770	670	680	21712-0810	145A1	31.540	31.890	801	810
21700-0680	145A1	26.770	27.170	680	690	21712-0840	145A1	32.700	33.110	831	841
21700-0690	145A1	27.170	27.560	690	700	21712-0850	145A1	33.110	33.500	841	851
21700-0700	145A1	27.560	27.950	700	710	21712-1575	145A1	61.810	62.990	1570	1600
21700-0730	145A1	28.740	29.130	730	740	21712-1900	145A1	73.030	75.000	1855	1905
21700-0740	145A1	29.130	29.530	740	750	21722-0560	145A1	22.050	22.240	560	565
21700-0750	145A1	29.530	29.840	750	758	21722-0650	145A1	25.590	25.980	650	660
21700-0760	145A1	29.840	30.160	758	766	21722-0690	145A1	27.170	27.560	690	700
21700-0770	145A1	30.160	30.470	766	774	21722-0730	145A1	28.740	29.130	730	740
21700-0790	145A1	30.830	31.180	783	792	21722-0790	145A1	30.830	31.180	783	792
21700-0800	145A1	31.180	31.540	792	801	21750-0160	145A2	6.100	6.500	155	165
21700-0820	145A1	31.890	32.320	810	821	21750-0180	145A2	6.890	7.200	175	183
21700-0830	145A1	32.320	32.720	821	831	21750-0200	145A2	7.480	8.270	190	210
21700-0840	145A1	32.720	33.110	831	841	21750-0220	145A2	8.270	9.250	210	235
21700-0880	145A1	34.290	34.720	871	882	21750-0250	145A2	9.250	10.430	235	265
21700-0890	145A1	34.720	35.120	882	892	21750-0275	145A2	10.430	11.420	265	290

All dimensions are in inches. Preferred sizes are indicated with **bold** type face.  
 Sizes listed are for standard nitrile elements, except Models 25 and 62 which have PTFE elements. Other material available on inquiry only.

## Face Seals by Model Number

Product Code	Model	Inches		MM		Product Code	Model	Inches		MM	
		ID	OD Width	ID	OD Width			ID	OD Width	ID	OD Width
21750-0300	145A2	11.420	12.200	290	310	21754-0550	145A2	20.870	22.830	530	580
21750-0325	145A2	12.200	13.190	310	335	21754-0650	145A2	24.800	26.180	630	665
21750-0350	145A2	13.190	14.370	335	365	21754-0725	145A2	27.760	29.330	705	745
21750-0375	145A2	14.370	15.350	365	390	21754-0800	145A2	30.910	32.680	785	830
21750-0400	145A2	15.350	16.930	390	430	21754-1150	145A2	43.900	45.870	1115	1165
21750-0450	145A2	16.930	18.900	430	480	21754-1250	145A2	47.840	50.000	1215	1270
21750-0475	145A2	17.920	19.890	455	505	21748-0170	145L	6.500	6.890	165	175
21750-0500	145A2	18.900	20.870	480	530	21748-0275	145L	10.240	11.220	260	285
21750-0550	145A2	20.870	22.830	530	580	21748-0300	145L	11.200	12.200	284	310
21750-0600	145A2	22.830	24.800	580	630	21748-0325	145L	12.200	13.190	310	335
21750-0650	145A2	24.800	26.180	630	665	21748-0350	145L	13.190	14.370	335	365
21750-0700	145A2	26.180	27.760	665	705	21748-0375	145L	14.370	15.190	365	386
21750-0725	145A2	27.760	29.330	705	745	21748-0450	145L	16.730	18.700	425	475
21750-0750	145A2	29.330	30.910	745	785						
21750-0800	145A2	30.910	32.680	785	830						
21750-0850	145A2	32.680	34.450	830	875						
21750-0900	145A2	34.450	36.220	875	920						
21750-0950	145A2	36.220	37.990	920	965						
21750-1000	145A2	37.990	39.960	965	1015						
21750-1050	145A2	39.960	41.930	1015	1065						
21750-1100	145A2	41.930	43.900	1065	1115						
21750-1150	145A2	43.900	45.870	1115	1165						
21750-1200	145A2	45.870	47.840	1165	1215						
21750-1250	145A2	47.840	50.000	1215	1270						
21750-1300	145A2	50.000	51.970	1270	1320						
21750-1350	145A2	51.970	53.940	1320	1370						
21750-1400	145A2	53.940	55.910	1370	1420						
21750-1450	145A2	55.910	57.870	1420	1470						
21750-1550	145A2	59.840	61.810	1520	1570						
21750-1750	145A2	67.720	69.690	1720	1770						
21750-1950	145A2	75.590	77.560	1920	1970						
21750-2250	145A2	87.500	89.500	2223	2273						
21751-0180	145A2	6.890	7.290	175	185						
21751-0200	145A2	7.480	8.270	190	210						
21751-0220	145A2	8.270	9.250	210	235						
21751-0250	145A2	9.250	10.430	235	265						
21751-0275	145A2	10.430	11.420	265	290						
21751-0300	145A2	11.420	12.200	290	310						
21751-0400	145A2	15.350	16.930	390	430						
21751-0450	145A2	16.930	18.900	430	480						
21751-0500	145A2	18.900	20.870	480	530						
21751-0550	145A2	20.870	22.830	530	580						
21751-0600	145A2	22.830	24.800	580	630						
21751-0650	145A2	24.800	26.180	630	665						
21751-0700	145A2	26.180	27.760	665	705						
21751-0725	145A2	27.760	29.330	705	745						
21751-0800	145A2	30.910	32.680	785	830						
21751-0950	145A2	36.220	37.990	920	965						
21751-1250	145A2	47.840	50.000	1215	1270						
21754-0180	145A2	6.890	7.290	175	185						
21754-0200	145A2	7.480	8.270	190	210						
21754-0250	145A2	9.250	10.430	235	265						
21754-0375	145A2	14.370	15.350	365	390						
21754-0400	145A2	15.350	16.930	390	430						
21754-0450	145A2	16.930	18.900	430	480						
21754-0500	145A2	18.900	20.870	480	530						

All dimensions are in inches. Preferred sizes are indicated with **bold** type face.

Sizes listed are for standard nitrile elements, except Models 25 and 62 which have PTFE elements. Other material available on inquiry only.



**TIMKEN**

**Seals by Shaft size**



### Using This Catalog

The following pages contain the information you need to make accurate decisions about the seals best suited for your standard applications. This catalog lists Timken oil seals and bearing isolators by shaft size and includes:

Dimensions (inch and metric) for bore and width, model numbers and part numbers.

Preferred sizes appearing in bold typeface.

Part number listing and additional information on inch and metric rod scrapers.

Reference chart showing relationship between RPM, FPM and shaft diameters.

To learn about Timken oil seals for non-standard applications, contact your Timken sales representative.

# Index for Shaft Size

<b>Model Number to Part Number Conversion</b>	S-4
<b>Timken Oil Seals and Bearing Isolators by Shaft Size</b>	S-5
<b>Timken Face Seals and Bearing Isolators by Shaft Sizes</b>	S-166

## Model Number to Part Number Conversion

Model No.	Prefix	Model No.	Prefix
3	28003	68	21823
21	25001	68R2	23727
23	25003	71	26001
24	25005	76	26193
25	25058		
		87	26080
26	24600	88	26088
26R1	24620	88NS	26188
53	21086	91	27023
53F1	22987	92	27063
53R1	22537		
		94	27223
53R2	22627	111	21011
53T2	22897	113	21012
53TB	22807	123	21016
53TF	22994	142	21432
54	21140		
		145A1	21700
58	21003	145A2	21750
59	24700	EQ	24801
61	24060	EQ	24802
61 FDA	24061	EQ	24807
61 DBL TANDEM	24062		
		EQSPB	24816
61 DBL OPPOSED	24063	IG	29500
61 REVERSE LIP	24064	IG	29502
62	21702	IG	29507
63	21158	IG	29519
63F1	23078		
		IGSPB	29516
63R1	23547		
63R2	23548		
63T2	23550		
63TB	23549		
63TF	23735		
64	21238		
66	21527		
66F1	23692		
66R1	23722		
66R2	23702		
66T2	23728		
66TF	23763		
67	21528		
67R2	23683		
67T2	23621		

## Oil Seals by Model Number

Product Code	Model	Inches			MM			Product Code	Model	Inches			MM		
		ID	OD	Width	ID	OD	Width			ID	OD	Width	ID	OD	Width
24060-7727	61	0.188	0.750	0.250	5	19	6	24060-0017	61	0.375	1.000	0.312	10	25	8
21695-7727	63	0.188	0.750	0.250	5	19	6	21159-0017	63	0.375	1.000	0.313	10	25	8
21158-7727	63	0.188	0.750	0.250	5	19	6	21158-0017	63	0.375	1.000	0.313	10	25	8
24060-3863	61	0.250	0.750	0.250	6	19	6	21695-0017	63	0.375	1.000	0.313	10	25	8
24071-3863	61	0.250	0.750	0.250	6	19	6	23078-0018	63F1	0.375	1.000	0.375	10	25	10
21159-3863	63	0.250	0.750	0.250	6	19	6	21158-0018	63	0.375	1.000	0.375	10	25	10
21158-3863	63	0.250	0.750	0.250	6	19	6	21158-0019	63	0.375	1.125	0.313	10	29	8
21542-3863	63	0.250	0.750	0.250	6	19	6	21159-0021	63	0.375	1.250	0.313	10	32	8
21695-3863	63	0.250	0.750	0.250	6	19	6	21158-0021	63	0.375	1.250	0.313	10	32	8
23547-7146	63R1	0.250	0.750	0.469	6	19	12	21168-0021	63	0.375	1.250	0.313	10	32	8
23550-7146	63T2	0.250	0.750	0.469	6	19	12	21695-0021	63	0.375	1.250	0.313	10	32	8
21158-3864	63	0.250	0.875	0.250	6	22	6	27023-2482	91	0.375	1.259	0.146	10	32	4
21695-3864	63	0.250	0.875	0.250	6	22	6	21158-8007	63	0.375	1.260	0.312	10	32	8
21159-0001	63	0.281	0.750	0.250	7	19	6	24060-0023	61	0.375	1.375	0.312	10	35	8
21158-0001	63	0.281	0.750	0.250	7	19	6	26193-0168	76	0.394	0.787	0.157	10	20	4
21542-0001	63	0.281	0.750	0.250	7	19	6	21159-0025	63	0.406	0.875	0.250	10	22	6
24060-0005	61	0.312	0.750	0.250	8	19	6	21702-0025	62	0.406	0.875	0.312	10	22	8
27023-6053	91	0.313	0.563	0.156	8	14	4	21695-0971	63	0.406	0.875	0.312	10	22	8
24060-3457	61	0.313	0.687	0.188	8	17	5	21158-0971	63	0.406	0.875	0.313	10	22	8
21158-0005	63	0.313	0.750	0.250	8	19	6	21158-0027	63	0.406	1.000	0.313	10	25	8
21542-0005	63	0.313	0.750	0.250	8	19	6	21163-0029	63	0.406	1.125	0.312	10	29	8
21158-0006	63	0.313	0.750	0.313	8	19	8	21158-0029	63	0.406	1.125	0.313	10	29	8
21163-0007	63	0.313	0.875	0.250	8	22	6	21158-0034	63	0.406	1.375	0.375	10	35	10
21158-0007	63	0.313	0.875	0.250	8	22	6	27023-2481	91	0.433	1.259	0.146	11	32	4
21158-0008	63	0.313	0.875	0.313	8	22	8	21695-0035	63	0.437	0.875	0.313	11	22	8
24060-1748	61	0.315	0.709	0.197	8	18	5	23561-5893	63R1	0.437	0.875	0.594	11	22	15
21168-0009	63	0.344	0.750	0.250	9	19	6	23712-5893	63R1	0.437	0.875	0.594	11	22	15
21158-0009	63	0.344	0.750	0.250	9	19	6	21163-0037	63	0.437	1.000	0.313	11	25	8
21158-0011	63	0.344	0.875	0.250	9	22	6	21158-0038	63	0.437	1.000	0.375	11	25	10
26001-7004	71	0.375	0.563	0.094	10	14	2	24807-3242	EQUAL	0.437	1.124	0.690	11	29	18
26001-7005	71	0.375	0.625	0.125	10	16	3	21158-8101	63	0.437	1.182	0.312	11	30	8
24125-0013	61	0.375	0.750	0.250	10	19	6	21158-0042	63	0.437	1.250	0.375	11	32	10
24060-0013	61	0.375	0.750	0.250	10	19	6	21158-3865	63	0.437	1.375	0.313	11	35	8
24124-0013	61	0.375	0.750	0.250	10	19	6	21158-8337	63	0.437	1.378	0.312	11	35	8
24071-0013	61	0.375	0.750	0.250	10	19	6	26001-6060	71	0.438	0.688	0.125	11	17	3
21158-0013	63	0.375	0.750	0.250	10	19	6	26001-7007	71	0.438	0.875	0.188	11	22	5
21506-0013	63	0.375	0.750	0.250	10	19	6	21158-0035	63	0.438	0.875	0.313	11	22	8
21168-0013	63	0.375	0.750	0.250	10	19	6	21618-0035	63	0.438	0.875	0.313	11	22	8
26001-0013	71	0.375	0.750	0.250	10	19	6	23547-5893	63R1	0.438	0.875	0.594	11	22	15
26193-0013	76	0.375	0.750	0.250	10	19	6	21702-0037	62	0.438	1.000	0.313	11	25	8
21158-0014	63	0.375	0.750	0.312	10	19	8	21158-0037	63	0.438	1.000	0.313	11	25	8
21159-0014	63	0.375	0.750	0.313	10	19	8	21158-0039	63	0.438	1.125	0.313	11	29	8
24060-4622	61	0.375	0.875	0.196	10	22	5	21158-0041	63	0.438	1.250	0.313	11	32	8
24060-0015	61	0.375	0.875	0.250	10	22	6	21158-8011	63	0.438	1.260	0.313	11	32	8
24077-0015	61	0.375	0.875	0.250	10	22	6	26001-7009	71	0.469	0.703	0.125	12	18	3
24116-0015	61	0.375	0.875	0.250	10	22	6	26193-9329	76	0.469	0.875	0.312	12	22	8
21290-0015	63	0.375	0.875	0.250	10	22	6	21158-0043	63	0.469	1.000	0.313	12	25	8
21159-0015	63	0.375	0.875	0.250	10	22	6	21158-0045	63	0.469	1.125	0.313	12	29	8
21391-0015	63	0.375	0.875	0.250	10	22	6	21158-0047	63	0.469	1.250	0.312	12	32	8
21158-0015	63	0.375	0.875	0.250	10	22	6	21158-6623	63	0.469	1.260	0.313	12	32	8
21542-0015	63	0.375	0.875	0.250	10	22	6	21158-3867	63	0.469	1.375	0.313	12	35	8
21695-0015	63	0.375	0.875	0.250	10	22	6	24060-4229	61	0.472	0.875	0.276	12	22	7
21920-0015	66	0.375	0.875	0.250	10	22	6	26193-0200	76	0.472	0.866	0.276	12	22	7
21527-0015	66	0.375	0.875	0.250	10	22	6	24060-0024	61	0.472	1.102	0.276	12	28	7
21158-0016	63	0.375	0.875	0.313	10	22	8	26001-7011	71	0.500	0.688	0.094	13	17	2
23548-8496	63R2	0.375	0.875	0.469	10	22	12	26001-7012	71	0.500	0.688	0.125	13	17	3

All dimensions are in inches. Preferred sizes are indicated with **bold** type face.

Sizes listed are for standard nitrile elements, except Models 25 and 62 which have PTFE elements. Other material available on inquiry only.



## Oil Seals by Model Number

Product Code	Model	Inches			MM			Product Code	Model	Inches			MM		
		ID	OD	Width	ID	OD	Width			ID	OD	Width	ID	OD	Width
26001-7013	71	0.500	0.750	0.125	13	19	3	21695-0067	63	0.563	1.125	0.313	14	29	8
26193-6071	76	0.500	0.801	0.188	13	20	5	21528-0067	67	0.563	1.125	0.313	14	29	8
27223-6074	94	0.500	0.875	0.234	13	22	6	21163-0068	63	0.563	1.125	0.375	14	29	10
26193-7501	76	0.500	0.875	0.313	13	22	8	23548-6567	63R2	0.563	1.125	0.563	14	29	14
24060-9505	61	0.500	1.000	0.250	13	25	6	23627-6567	63R2	0.563	1.125	0.563	14	29	14
24060-0049	61	0.500	1.000	0.312	13	25	8	29507-6076	IG	0.563	1.125	0.625	14	29	16
21767-0049	62	0.500	1.000	0.313	13	25	8	21158-0069	63	0.563	1.250	0.313	14	32	8
21702-0049	62	0.500	1.000	0.313	13	25	8	21163-0069	63	0.563	1.250	0.313	14	32	8
21159-0049	63	0.500	1.000	0.313	13	25	8	21618-0069	63	0.563	1.250	0.313	14	32	8
21158-0049	63	0.500	1.000	0.313	13	25	8	24064-0070	61	0.563	1.250	0.375	14	32	10
21695-0049	63	0.500	1.000	0.313	13	25	8	24060-0070	61	0.563	1.250	0.375	14	32	10
21168-0049	63	0.500	1.000	0.313	13	25	8	21158-0070	63	0.563	1.250	0.375	14	32	10
21795-0049	63	0.500	1.000	0.313	13	25	8	21158-6643	63	0.563	1.260	0.313	14	32	8
24062-0050	61	0.500	1.000	0.375	13	25	10	21158-0071	63	0.563	1.375	0.313	14	35	8
21702-0050	62	0.500	1.000	0.375	13	25	10	23550-8267	63T2	0.563	1.375	0.563	14	35	14
21158-0050	63	0.500	1.000	0.375	13	25	10	21158-0073	63	0.563	1.500	0.313	14	38	8
24060-6077	61	0.500	1.125	0.250	13	29	6	21158-0075	63	0.563	1.575	0.313	14	40	8
24110-6077	61	0.500	1.125	0.250	13	29	6	29507-5817	IG	0.590	1.375	0.625	15	35	16
21702-0051	62	0.500	1.125	0.313	13	29	8	24060-8020	61	0.591	1.182	0.315	15	30	8
21159-0051	63	0.500	1.125	0.313	13	29	8	24819-4608	EQUAL	0.591	1.750	0.625	15	44	16
21158-0051	63	0.500	1.125	0.313	13	29	8	21158-0077	63	0.594	1.125	0.313	15	29	8
21528-0051	67	0.500	1.125	0.313	13	29	8	21158-0078	63	0.594	1.125	0.375	15	29	10
21823-0051	68	0.500	1.125	0.313	13	29	8	21163-0078	63	0.594	1.125	0.375	15	29	10
21702-0052	62	0.500	1.125	0.375	13	29	10	23078-8318	63F1	0.594	1.125	0.438	15	29	11
21168-0052	63	0.500	1.125	0.375	13	29	10	21158-0079	63	0.594	1.250	0.313	15	32	8
21158-0052	63	0.500	1.125	0.375	13	29	10	21163-0080	63	0.594	1.250	0.375	15	32	10
23078-5391	63F1	0.500	1.125	0.531	13	29	13	21158-8021	63	0.594	1.260	0.313	15	32	8
23078-6986	63F1	0.500	1.125	0.563	13	29	14	21158-0081	63	0.594	1.375	0.313	15	35	8
24060-7016	61	0.500	1.250	0.250	13	32	6	21158-0082	63	0.594	1.375	0.375	15	35	10
21290-0053	63	0.500	1.250	0.312	13	32	8	24805-3097	EQUAL	0.594	1.375	0.625	15	35	16
21158-0053	63	0.500	1.250	0.313	13	32	8	21158-8109	63	0.594	1.378	0.313	15	35	8
21158-0054	63	0.500	1.250	0.375	13	32	10	21158-0083	63	0.594	1.500	0.313	15	38	8
24060-0055	61	0.500	1.375	0.312	13	35	8	21158-0085	63	0.594	1.575	0.312	15	40	8
21159-0055	63	0.500	1.375	0.313	13	35	8	29507-6506	IG	0.600	1.575	0.625	15	40	16
21158-0055	63	0.500	1.375	0.313	13	35	8	26001-7020	71	0.625	0.813	0.094	16	21	2
21528-0055	67	0.500	1.375	0.313	13	35	8	26193-5299	76	0.625	0.875	0.187	16	22	5
21702-8102	62	0.500	1.378	0.313	13	35	8	26001-7024	71	0.625	1.000	0.125	16	25	3
21158-0057	63	0.500	1.500	0.313	13	38	8	26001-7021	71	0.625	1.000	0.250	16	25	6
21158-0058	63	0.500	1.500	0.375	13	38	10	27223-7021	94	0.625	1.000	0.250	16	25	6
24801-4568	EQUAL	0.512	1.606	0.625	13	41	16	26001-7022	71	0.625	1.062	0.188	16	27	5
24802-4568	EQUAL	0.512	1.606	0.625	13	41	16	26001-9428	71	0.625	1.125	0.125	16	29	3
21158-0059	63	0.531	1.125	0.313	13	29	8	26001-7023	71	0.625	1.125	0.188	16	29	5
21158-0061	63	0.531	1.250	0.313	13	32	8	24060-0087	61	0.625	1.125	0.312	16	29	8
21158-0063	63	0.531	1.375	0.313	13	35	8	21168-0087	63	0.625	1.125	0.312	16	29	8
21158-0065	63	0.531	1.500	0.313	13	38	8	21767-0087	62	0.625	1.125	0.313	16	29	8
21702-3869	62	0.562	1.000	0.312	14	25	8	21702-0087	62	0.625	1.125	0.313	16	29	8
21158-0068	63	0.562	1.125	0.375	14	29	10	21695-0087	63	0.625	1.125	0.313	16	29	8
21158-8018	63	0.562	1.182	0.312	14	30	8	21159-0087	63	0.625	1.125	0.313	16	29	8
26001-7017	71	0.563	0.750	0.094	14	19	2	21158-0087	63	0.625	1.125	0.313	16	29	8
26193-7503	76	0.563	0.875	0.188	14	22	5	21173-0087	63	0.625	1.125	0.313	16	29	8
27023-7503	91	0.563	0.875	0.188	14	22	5	21528-0087	67	0.625	1.125	0.313	16	29	8
26193-7504	76	0.563	1.000	0.188	14	25	5	24076-0088	61	0.625	1.125	0.375	16	29	10
21767-3869	62	0.563	1.000	0.313	14	25	8	21159-0088	63	0.625	1.125	0.375	16	29	10
21158-3869	63	0.563	1.000	0.313	14	25	8	21158-0088	63	0.625	1.125	0.375	16	29	10
21158-0067	63	0.563	1.125	0.313	14	29	8	23078-5657	63F1	0.625	1.125	0.500	16	29	13
21163-0067	63	0.563	1.125	0.313	14	29	8	23548-6637	63R2	0.625	1.125	0.563	16	29	14

All dimensions are in inches. Preferred sizes are indicated with **bold** type face. Sizes listed are for standard nitrile elements, except Models 25 and 62 which have PTFE elements. Other material available on inquiry only.

## Oil Seals by Model Number

Product Code	Model	Inches			MM			Product Code	Model	Inches			MM		
		ID	OD	Width	ID	OD	Width			ID	OD	Width	ID	OD	Width
23550-6637	63T2	0.625	1.125	0.563	16	29	14	21702-5105	62	0.669	1.375	0.313	17	35	8
21158-8023	63	0.625	1.182	0.313	16	30	8	23550-7405	63T2	0.669	1.575	0.563	17	40	14
24060-9509	61	0.625	1.250	0.250	16	32	6	29507-5416	IG	0.669	1.575	0.625	17	40	16
24060-0089	61	0.625	1.250	0.312	16	32	8	24801-5416	EQUAL	0.669	1.575	0.625	17	40	16
21767-0089	62	0.625	1.250	0.313	16	32	8	24060-1755	61	0.669	1.378	0.315	17	35	8
21159-0089	63	0.625	1.250	0.313	16	32	8	27223-2628	94	0.669	1.575	0.551	17	40	14
21158-0089	63	0.625	1.250	0.313	16	32	8	24060-1754	61	0.670	1.103	0.315	17	28	8
21795-0089	63	0.625	1.250	0.313	16	32	8	29519-5951	IG	0.670	1.850	0.625	17	47	16
21695-0089	63	0.625	1.250	0.313	16	32	8	29502-5951	IG	0.670	1.850	0.750	17	47	19
21528-0089	67	0.625	1.250	0.313	16	32	8	24060-0109	61	0.687	1.125	0.312	17	29	8
24060-0090	61	0.625	1.250	0.375	16	32	10	21158-0112	63	0.687	1.250	0.375	17	32	10
21158-0090	63	0.625	1.250	0.375	16	32	10	21158-8029	63	0.687	1.260	0.312	17	32	8
21164-0090	63	0.625	1.250	0.375	16	32	10	21158-0116	63	0.687	1.500	0.375	17	38	10
23078-7662	63F1	0.625	1.250	0.438	16	32	11	26001-7025	71	0.688	0.875	0.094	17	22	2
23547-7150	63R1	0.625	1.250	0.562	16	32	14	26193-7505	76	0.688	1.062	0.188	17	27	5
23550-7150	63T2	0.625	1.250	0.563	16	32	14	21158-0109	63	0.688	1.125	0.313	17	29	8
29507-4317	IG	0.625	1.250	0.625	16	32	16	21702-0110	62	0.688	1.125	0.375	17	29	10
24807-2828	EQUAL	0.625	1.250	0.690	16	32	18	29507-4724	IG	0.688	1.125	0.625	17	29	16
29507-4637	IG	0.625	1.300	0.625	16	33	16	21702-0111	62	0.688	1.250	0.313	17	32	8
24060-0091	61	0.625	1.375	0.312	16	35	8	21158-0111	63	0.688	1.250	0.313	17	32	8
24110-0091	61	0.625	1.375	0.312	16	35	8	21159-0112	63	0.688	1.250	0.375	17	32	10
21702-0091	62	0.625	1.375	0.313	16	35	8	23078-5041	63F1	0.688	1.250	0.438	17	32	11
21695-0091	63	0.625	1.375	0.313	16	35	8	21163-8029	63	0.688	1.260	0.313	17	32	8
21158-0091	63	0.625	1.375	0.313	16	35	8	26001-9758	71	0.688	1.375	0.125	17	35	3
24063-0092	61	0.625	1.375	0.375	16	35	10	21158-0113	63	0.688	1.375	0.313	17	35	8
23502-0086	63G1	0.625	1.375	0.437	16	35	11	21177-0113	63	0.688	1.375	0.313	17	35	8
23548-6856	63R2	0.625	1.375	0.563	16	35	14	21158-0115	63	0.688	1.500	0.313	17	38	8
23550-6856	63T2	0.625	1.375	0.563	16	35	14	21528-0117	67	0.688	1.575	0.313	17	40	8
29507-6439	IG	0.625	1.375	0.625	16	35	16	24060-0074	61	0.709	1.181	0.276	18	30	7
24802-1328	EQUAL	0.625	1.375	0.625	16	35	16	21168-0121	63	0.719	1.250	0.312	18	32	8
29521-6146	IG	0.625	1.375	0.875	16	35	22	21158-0121	63	0.719	1.250	0.313	18	32	8
21158-8342	63	0.625	1.378	0.313	16	35	8	21158-0123	63	0.719	1.375	0.313	18	35	8
24060-0093	61	0.625	1.500	0.313	16	38	8	21158-0124	63	0.719	1.375	0.375	18	35	10
21158-0093	63	0.625	1.500	0.313	16	38	8	21158-0126	63	0.719	1.499	0.375	18	38	10
21695-0094	63	0.625	1.500	0.375	16	38	10	21158-0125	63	0.719	1.500	0.313	18	38	8
23548-8339	63R2	0.625	1.500	0.562	16	38	14	21158-0129	63	0.719	1.625	0.313	18	41	8
21500-0095	63	0.625	1.575	0.313	16	40	8	21158-0133	63	0.719	1.828	0.375	18	46	10
21158-0095	63	0.625	1.575	0.313	16	40	8	21158-0135	63	0.719	1.875	0.375	18	48	10
21702-0096	62	0.625	1.575	0.375	16	40	10	24801-5223	EQUAL	0.748	1.496	0.625	19	38	16
27223-0096	94	0.625	1.575	0.375	16	40	10	26001-7826	71	0.750	0.938	0.125	19	24	3
24063-2725	61	0.625	1.625	0.438	16	41	11	26001-7027	71	0.750	1.000	0.125	19	25	3
29520-4266	IG	0.625	1.625	0.750	16	41	19	26001-7028	71	0.750	1.062	0.188	19	27	5
26193-0190	76	0.630	1.102	0.276	16	28	7	26001-7030	71	0.750	1.125	0.125	19	29	3
24062-2280	61	0.630	1.182	0.315	16	30	8	29507-5283	IG	0.750	1.125	0.625	19	29	16
24060-2280	61	0.630	1.182	0.315	16	30	8	26001-7031	71	0.750	1.188	0.156	19	30	4
21702-0097	62	0.656	1.125	0.313	17	29	8	26001-7032	71	0.750	1.250	0.125	19	32	3
21158-0097	63	0.656	1.125	0.313	17	29	8	25058-7033	25	0.750	1.250	0.250	19	32	6
21158-0099	63	0.656	1.250	0.313	17	32	8	24600-7033	26	0.750	1.250	0.250	19	32	6
21158-0100	63	0.656	1.250	0.375	17	32	10	26001-7033	71	0.750	1.250	0.250	19	32	6
21158-0101	63	0.656	1.375	0.313	17	35	8	27223-7033	94	0.750	1.250	0.250	19	32	6
21158-4793	63	0.656	1.378	0.313	17	35	8	24060-0139	61	0.750	1.250	0.312	19	32	8
21158-0103	63	0.656	1.500	0.313	17	38	8	21767-0139	62	0.750	1.250	0.313	19	32	8
21158-0104	63	0.656	1.500	0.375	17	38	10	21702-0139	62	0.750	1.250	0.313	19	32	8
21158-0105	63	0.656	1.575	0.313	17	40	8	21173-0139	63	0.750	1.250	0.313	19	32	8
21158-0107	63	0.656	1.625	0.313	17	41	8	21294-0139	63	0.750	1.250	0.313	19	32	8
26001-8379	71	0.667	1.188	0.125	17	30	3	21158-0139	63	0.750	1.250	0.313	19	32	8

All dimensions are in inches. Preferred sizes are indicated with **bold** type face.

Sizes listed are for standard nitrile elements, except Models 25 and 62 which have PTFE elements. Other material available on inquiry only.

## Oil Seals by Model Number

Product Code	Model	Inches			MM			Product Code	Model	Inches			MM		
		ID	OD	Width	ID	OD	Width			ID	OD	Width	ID	OD	Width
21168-0139	63	0.750	1.250	0.313	19	32	8	24077-0147	61	0.750	1.625	0.312	19	41	8
21695-0139	63	0.750	1.250	0.313	19	32	8	21702-0147	62	0.750	1.625	0.313	19	41	8
21527-0139	66	0.750	1.250	0.313	19	32	8	21158-0147	63	0.750	1.625	0.313	19	41	8
21528-0139	67	0.750	1.250	0.313	19	32	8	21919-0147	63	0.750	1.625	0.313	19	41	8
27223-0139	94	0.750	1.250	0.313	19	32	8	24110-0148	61	0.750	1.625	0.375	19	41	10
21158-0140	63	0.750	1.250	0.375	19	32	10	29609-1273	GD	0.750	1.625	0.375	19	41	10
24063-6612	61	0.750	1.250	0.438	19	32	11	29519-6149	IG	0.750	1.625	0.625	19	41	16
23078-6612	63F1	0.750	1.250	0.438	19	32	11	21158-8035	63	0.750	1.654	0.313	19	42	8
23548-6720	63R2	0.750	1.250	0.563	19	32	14	24060-1247	61	0.750	1.750	0.312	19	44	8
23550-6720	63T2	0.750	1.250	0.563	19	32	14	24060-0149	61	0.750	1.750	0.375	19	44	10
23683-6720	67R2	0.750	1.250	0.563	19	32	14	24110-0149	61	0.750	1.750	0.375	19	44	10
29507-6055	IG	0.750	1.250	0.625	19	32	16	21158-0149	63	0.750	1.750	0.375	19	44	10
21158-8033	63	0.750	1.260	0.313	19	32	8	21695-0149	63	0.750	1.750	0.375	19	44	10
21158-3870	63	0.750	1.260	0.406	19	32	10	21158-0150	63	0.750	1.750	0.438	19	44	11
24060-2587	61	0.750	1.312	0.250	19	33	6	29507-5282	IG	0.750	1.750	0.625	19	44	16
26001-7034	71	0.750	1.375	0.250	19	35	6	29519-3776	IG	0.750	1.750	0.625	19	44	16
24060-0141	61	0.750	1.375	0.312	19	35	8	24848-3776	EQUAL	0.750	1.750	0.625	19	44	16
21767-0141	62	0.750	1.375	0.313	19	35	8	23550-2577	63T2	0.750	1.750	0.688	19	44	17
21702-0141	62	0.750	1.375	0.313	19	35	8	21158-0151	63	0.750	1.828	0.375	19	46	10
21158-0141	63	0.750	1.375	0.313	19	35	8	21528-0151	67	0.750	1.828	0.375	19	46	10
21500-0141	63	0.750	1.375	0.313	19	35	8	21158-0152	63	0.750	1.828	0.437	19	46	11
21168-0141	63	0.750	1.375	0.313	19	35	8	21158-4935	63	0.750	1.850	0.312	19	47	8
21528-0141	67	0.750	1.375	0.313	19	35	8	21695-4935	63	0.750	1.850	0.312	19	47	8
27223-0141	94	0.750	1.375	0.313	19	35	8	21158-6120	63	0.750	1.851	0.375	19	47	10
21158-0142	63	0.750	1.375	0.375	19	35	10	27223-6120	94	0.750	1.851	0.375	19	47	10
23078-6927	63F1	0.750	1.375	0.438	19	35	11	21767-0153	62	0.750	1.875	0.375	19	48	10
23547-4754	63R1	0.750	1.375	0.563	19	35	14	21159-0153	63	0.750	1.875	0.375	19	48	10
23550-4754	63T2	0.750	1.375	0.563	19	35	14	21158-0153	63	0.750	1.875	0.375	19	48	10
24060-8344	61	0.750	1.378	0.312	19	35	8	29507-4551	IG	0.750	1.875	0.625	19	48	16
21158-8344	63	0.750	1.378	0.312	19	35	8	21158-0155	63	0.750	1.984	0.375	19	50	10
29507-5384	IG	0.750	1.378	0.625	19	35	16	26001-7705	71	0.781	1.250	0.188	20	32	5
24807-1786	EQUAL	0.750	1.379	0.690	19	35	18	21702-0157	62	0.781	1.250	0.313	20	32	8
24802-1405	EQUAL	0.750	1.499	0.625	19	38	16	21163-0157	63	0.781	1.250	0.313	20	32	8
24812-1405	EQUAL	0.750	1.499	0.625	19	38	16	21695-0157	63	0.781	1.250	0.313	20	32	8
24060-0143	61	0.750	1.500	0.312	19	38	8	21158-0157	63	0.781	1.250	0.313	20	32	8
21702-0143	62	0.750	1.500	0.313	19	38	8	21158-0158	63	0.781	1.250	0.375	20	32	10
21158-0143	63	0.750	1.500	0.313	19	38	8	21528-0158	67	0.781	1.250	0.375	20	32	10
21164-0143	63	0.750	1.500	0.313	19	38	8	23550-8562	63T2	0.781	1.250	0.563	20	32	14
21919-0143	63	0.750	1.500	0.313	19	38	8	21168-0159	63	0.781	1.375	0.312	20	35	8
21695-0143	63	0.750	1.500	0.313	19	38	8	21767-0159	62	0.781	1.375	0.313	20	35	8
21959-0143	67	0.750	1.500	0.313	19	38	8	21702-0159	62	0.781	1.375	0.313	20	35	8
21528-0143	67	0.750	1.500	0.313	19	38	8	21158-0159	63	0.781	1.375	0.313	20	35	8
21923-0143	67	0.750	1.500	0.313	19	38	8	21163-0159	63	0.781	1.375	0.313	20	35	8
21951-0143	67	0.750	1.500	0.313	19	38	8	21164-0159	63	0.781	1.375	0.313	20	35	8
21702-0144	62	0.750	1.500	0.375	19	38	10	21695-0159	63	0.781	1.375	0.313	20	35	8
21159-0144	63	0.750	1.500	0.375	19	38	10	21159-0160	63	0.781	1.375	0.375	20	35	10
21475-0144	63	0.750	1.500	0.375	19	38	10	21755-0160	63	0.781	1.375	0.375	20	35	10
21158-0144	63	0.750	1.500	0.375	19	38	10	21528-0160	67	0.781	1.375	0.375	20	35	10
23550-7184	63T2	0.750	1.500	0.563	19	38	14	29507-5322	IG	0.781	1.375	0.625	20	35	16
29507-5562	IG	0.750	1.500	0.625	19	38	16	21158-4965	63	0.781	1.378	0.313	20	35	8
29609-6737	GD	0.750	1.567	0.375	19	40	10	21158-0161	63	0.781	1.500	0.313	20	38	8
29507-6172	IG	0.750	1.570	0.625	19	40	16	21163-0161	63	0.781	1.500	0.313	20	38	8
21159-0145	63	0.750	1.575	0.313	19	40	8	21158-0162	63	0.781	1.500	0.375	20	38	10
21158-0145	63	0.750	1.575	0.313	19	40	8	23550-6662	63T2	0.781	1.500	0.562	20	38	14
24801-3964	EQUAL	0.750	1.575	0.625	19	40	16	21158-0163	63	0.781	1.575	0.313	20	40	8
24060-0147	61	0.750	1.625	0.312	19	41	8	21158-0165	63	0.781	1.625	0.312	20	41	8

All dimensions are in inches. Preferred sizes are indicated with **bold** type face. Sizes listed are for standard nitrile elements, except Models 25 and 62 which have PTFE elements. Other material available on inquiry only.



**Oil Seals by Model Number**

Product Code	Model	Inches			MM			Product Code	Model	Inches			MM		
		ID	OD	Width	ID	OD	Width			ID	OD	Width	ID	OD	Width
27223-0215	94	0.875	1.500	0.313	22	38	8	24802-1403	EQUAL	0.875	1.938	0.625	22	49	16
24600-0784	26	0.875	1.500	0.375	22	38	10	29502-6731	IG	0.875	1.938	0.750	22	49	19
21702-0216	62	0.875	1.500	0.375	22	38	10	21158-0227	63	0.875	1.984	0.375	22	50	10
21159-0216	63	0.875	1.500	0.375	22	38	10	21158-0228	63	0.875	1.984	0.437	22	50	11
21158-0216	63	0.875	1.500	0.375	22	38	10	21158-0229	63	0.875	2.000	0.375	22	51	10
21695-0216	63	0.875	1.500	0.375	22	38	10	21695-0229	63	0.875	2.000	0.375	22	51	10
23547-4700	63R1	0.875	1.500	0.563	22	38	14	24801-0850	EQUAL	0.875	2.000	0.500	22	51	13
29507-4339	IG	0.875	1.500	0.625	22	38	16	24801-1765	EQUAL	0.875	2.000	0.625	22	51	16
24807-1955	EQUAL	0.875	1.500	0.690	22	38	18	24802-1765	EQUAL	0.875	2.000	0.625	22	51	16
24823-1955	EQUAL	0.875	1.500	0.690	22	38	18	24811-1765	EQUAL	0.875	2.000	0.625	22	51	16
27223-7465	94	0.875	1.570	0.313	22	40	8	21158-4849	63	0.875	2.047	0.375	22	52	10
26193-8952	76	0.875	1.575	0.188	22	40	5	21159-0231	63	0.875	2.062	0.375	22	52	10
21158-0217	63	0.875	1.575	0.313	22	40	8	21158-0231	63	0.875	2.062	0.375	22	52	10
21695-0217	63	0.875	1.575	0.313	22	40	8	29602-4731	GD	0.875	2.750	0.700	22	70	18
21158-0219	63	0.875	1.625	0.313	22	41	8	29502-4731	IG	0.875	2.750	0.750	22	70	19
21527-0219	66	0.875	1.625	0.313	22	41	8	29500-6025	IG	0.896	2.992	0.750	23	76	19
24600-1277	26	0.875	1.625	0.375	22	41	10	21158-0233	63	0.906	1.500	0.313	23	38	8
21159-0220	63	0.875	1.625	0.375	22	41	10	21158-0234	63	0.906	1.500	0.375	23	38	10
21158-0220	63	0.875	1.625	0.375	22	41	10	29507-5435	IG	0.906	1.500	0.625	23	38	16
24062-3849	61	0.875	1.625	0.438	22	41	11	21158-0235	63	0.906	1.575	0.313	23	40	8
23547-6476	63R1	0.875	1.625	0.562	22	41	14	21158-0237	63	0.906	1.625	0.313	23	41	8
29507-4123	IG	0.875	1.625	0.625	22	41	16	21163-0237	63	0.906	1.625	0.313	23	41	8
29607-4123	GD	0.875	1.625	0.625	22	41	16	21158-8050	63	0.906	1.654	0.313	23	42	8
24802-1012	EQUAL	0.875	1.625	0.625	22	41	16	21158-0239	63	0.906	1.750	0.375	23	44	10
24822-4123	EQUAL	0.875	1.625	0.625	22	41	16	21158-0245	63	0.906	1.984	0.375	23	50	10
24807-2861	EQUAL	0.875	1.625	0.690	22	41	18	21158-0247	63	0.906	2.000	0.375	23	51	10
29502-1309	IG	0.875	1.625	0.750	22	41	19	29602-6911	GD	0.928	2.000	0.700	24	51	18
29502-4123	IG	0.875	1.625	0.750	22	41	19	21158-0252	63	0.937	1.500	0.375	24	38	10
21158-8048	63	0.875	1.654	0.312	22	42	8	21168-0252	63	0.937	1.500	0.375	24	38	10
24060-0221	61	0.875	1.750	0.375	22	44	10	23547-4819	63R1	0.937	1.500	0.562	24	38	14
21158-0221	63	0.875	1.750	0.375	22	44	10	21158-0265	63	0.937	2.000	0.375	24	51	10
21695-0221	63	0.875	1.750	0.375	22	44	10	26001-7047	71	0.938	1.188	0.125	24	30	3
21158-0222	63	0.875	1.750	0.437	22	44	11	21951-6233	67	0.938	1.375	0.312	24	35	8
21159-0222	63	0.875	1.750	0.438	22	44	11	21767-6233	62	0.938	1.375	0.313	24	35	8
24801-0756	EQUAL	0.875	1.750	0.500	22	44	13	26193-6233	76	0.938	1.375	0.313	24	35	8
29507-1090	IG	0.875	1.750	0.625	22	44	16	21527-0251	66	0.938	1.500	0.312	24	38	8
24801-1090	EQUAL	0.875	1.750	0.625	22	44	16	21702-0251	62	0.938	1.500	0.313	24	38	8
24802-1090	EQUAL	0.875	1.750	0.625	22	44	16	21290-0251	63	0.938	1.500	0.313	24	38	8
24811-1090	EQUAL	0.875	1.750	0.625	22	44	16	21158-0251	63	0.938	1.500	0.313	24	38	8
24812-1090	EQUAL	0.875	1.750	0.625	22	44	16	21168-0251	63	0.938	1.500	0.313	24	38	8
29520-7423	IG	0.875	1.750	0.760	22	44	19	21695-0251	63	0.938	1.500	0.313	24	38	8
21158-0223	63	0.875	1.828	0.375	22	46	10	24600-0785	26	0.938	1.500	0.375	24	38	10
21527-0223	66	0.875	1.828	0.375	22	46	10	21290-0252	63	0.938	1.500	0.375	24	38	10
21158-0224	63	0.875	1.828	0.437	22	46	11	23550-4819	63T2	0.938	1.500	0.563	24	38	14
24600-1276	26	0.875	1.828	0.438	22	46	11	29507-4122	IG	0.938	1.500	0.625	24	38	16
21702-0224	62	0.875	1.828	0.438	22	46	11	24807-2563	EQUAL	0.938	1.500	0.690	24	38	18
21158-4748	63	0.875	1.851	0.375	22	47	10	24847-2563	EQUAL	0.938	1.500	0.690	24	38	18
24600-4657	26	0.875	1.875	0.312	22	48	8	21158-0253	63	0.938	1.575	0.313	24	40	8
24060-1271	61	0.875	1.875	0.312	22	48	8	21159-0255	63	0.938	1.625	0.313	24	41	8
21158-0225	63	0.875	1.875	0.375	22	48	10	21158-0255	63	0.938	1.625	0.313	24	41	8
21158-0226	63	0.875	1.875	0.437	22	48	11	21158-0256	63	0.938	1.625	0.375	24	41	10
24801-0625	EQUAL	0.875	1.875	0.500	22	48	13	24802-1115	EQUAL	0.938	1.688	0.625	24	43	16
29507-2711	IG	0.875	1.875	0.625	22	48	16	21158-0257	63	0.938	1.750	0.375	24	44	10
24802-2711	EQUAL	0.875	1.875	0.625	22	48	16	21158-0258	63	0.938	1.750	0.438	24	44	11
29602-4267	GD	0.875	1.875	0.700	22	48	18	21158-0259	63	0.938	1.828	0.375	24	46	10
24801-1403	EQUAL	0.875	1.938	0.625	22	49	16	21158-0260	63	0.938	1.828	0.438	24	46	11

All dimensions are in inches. Preferred sizes are indicated with **bold** type face. Sizes listed are for standard nitrile elements, except Models 25 and 62 which have PTFE elements. Other material available on inquiry only.



**Oil Seals by Model Number**

Product Code	Model	Inches			MM			Product Code	Model	Inches			MM		
		ID	OD	Width	ID	OD	Width			ID	OD	Width	ID	OD	Width
21823-0287	68	1.000	1.500	0.313	25	38	8	21158-0293	63	1.000	1.750	0.375	25	44	10
27223-0287	94	1.000	1.500	0.313	25	38	8	21163-0293	63	1.000	1.750	0.375	25	44	10
24610-0288	26	1.000	1.500	0.375	25	38	10	21173-0293	63	1.000	1.750	0.375	25	44	10
24062-0288	61	1.000	1.500	0.375	25	38	10	21168-0293	63	1.000	1.750	0.375	25	44	10
24060-0288	61	1.000	1.500	0.375	25	38	10	21795-0293	63	1.000	1.750	0.375	25	44	10
24063-0288	61	1.000	1.500	0.375	25	38	10	21695-0293	63	1.000	1.750	0.375	25	44	10
21702-0288	62	1.000	1.500	0.375	25	38	10	21158-0294	63	1.000	1.750	0.438	25	44	11
21158-0288	63	1.000	1.500	0.375	25	38	10	23078-6470	63F1	1.000	1.750	0.500	25	44	13
24063-5306	61	1.000	1.500	0.437	25	38	11	23547-9417	63R1	1.000	1.750	0.625	25	44	16
24063-6755	61	1.000	1.500	0.438	25	38	11	29507-3398	IG	1.000	1.750	0.625	25	44	16
24128-6755	61	1.000	1.500	0.438	25	38	11	24801-3398	EQUAL	1.000	1.750	0.625	25	44	16
23078-6755	63F1	1.000	1.500	0.438	25	38	11	24802-3398	EQUAL	1.000	1.750	0.625	25	44	16
23548-6694	63R2	1.000	1.500	0.563	25	38	14	24824-1283	EQUAL	1.000	1.750	0.625	25	44	16
23550-6694	63T2	1.000	1.500	0.563	25	38	14	23548-7215	63R2	1.000	1.750	0.687	25	44	17
23552-6694	63T2	1.000	1.500	0.563	25	38	14	23547-7215	63R1	1.000	1.750	0.688	25	44	17
29507-2684	IG	1.000	1.500	0.625	25	38	16	24807-2695	EQUAL	1.000	1.750	0.690	25	44	18
29509-2684	IG	1.000	1.500	0.625	25	38	16	29602-4182	GD	1.000	1.750	0.700	25	44	18
29621-2684	GD	1.000	1.500	0.625	25	38	16	29502-4182	IG	1.000	1.750	0.750	25	44	19
24807-2688	EQUAL	1.000	1.500	0.690	25	38	18	21158-0295	63	1.000	1.828	0.375	25	46	10
24814-2688	EQUAL	1.000	1.500	0.690	25	38	18	21158-0296	63	1.000	1.828	0.438	25	46	11
24834-2688	EQUAL	1.000	1.500	0.690	25	38	18	23548-6580	63R2	1.000	1.828	0.688	25	46	17
26001-6156	71	1.000	1.563	0.188	25	40	5	29699-0015	GD	1.000	1.828	0.700	25	46	18
21163-0289	63	1.000	1.575	0.312	25	40	8	27223-9967	94	1.000	1.851	0.250	25	47	6
21158-0289	63	1.000	1.575	0.313	25	40	8	21158-6906	63	1.000	1.851	0.375	25	47	10
24060-0290	61	1.000	1.575	0.375	25	40	10	24060-0297	61	1.000	1.875	0.375	25	48	10
21158-0290	63	1.000	1.575	0.375	25	40	10	21702-0297	62	1.000	1.875	0.375	25	48	10
24060-9490	61	1.000	1.625	0.250	25	41	6	21159-0297	63	1.000	1.875	0.375	25	48	10
21695-0291	63	1.000	1.625	0.312	25	41	8	21475-0297	63	1.000	1.875	0.375	25	48	10
21702-0291	62	1.000	1.625	0.313	25	41	8	21158-0297	63	1.000	1.875	0.375	25	48	10
21290-0291	63	1.000	1.625	0.313	25	41	8	21163-0297	63	1.000	1.875	0.375	25	48	10
21158-0291	63	1.000	1.625	0.313	25	41	8	21695-0297	63	1.000	1.875	0.375	25	48	10
21528-0291	67	1.000	1.625	0.313	25	41	8	21158-0298	63	1.000	1.875	0.437	25	48	11
24062-0292	61	1.000	1.625	0.375	25	41	10	24801-1754	EQUAL	1.000	1.875	0.625	25	48	16
24064-0292	61	1.000	1.625	0.375	25	41	10	24802-1754	EQUAL	1.000	1.875	0.625	25	48	16
24060-0292	61	1.000	1.625	0.375	25	41	10	24806-1754	EQUAL	1.000	1.875	0.625	25	48	16
24125-0292	61	1.000	1.625	0.375	25	41	10	24812-1754	EQUAL	1.000	1.875	0.625	25	48	16
21695-0292	63	1.000	1.625	0.375	25	41	10	24853-1754	EQUAL	1.000	1.875	0.625	25	48	16
21159-0292	63	1.000	1.625	0.375	25	41	10	23548-4887	63R2	1.000	1.875	0.688	25	48	17
21163-0292	63	1.000	1.625	0.375	25	41	10	21158-0299	63	1.000	1.984	0.375	25	50	10
21158-0292	63	1.000	1.625	0.375	25	41	10	24060-1272	61	1.000	2.000	0.312	25	51	8
23078-6524	63F1	1.000	1.625	0.438	25	41	11	21767-0301	62	1.000	2.000	0.375	25	51	10
23547-6477	63R1	1.000	1.625	0.563	25	41	14	21702-0301	62	1.000	2.000	0.375	25	51	10
23561-6477	63R1	1.000	1.625	0.563	25	41	14	21290-0301	63	1.000	2.000	0.375	25	51	10
23628-6477	63R2	1.000	1.625	0.563	25	41	14	21158-0301	63	1.000	2.000	0.375	25	51	10
23550-6477	63T2	1.000	1.625	0.563	25	41	14	21500-0301	63	1.000	2.000	0.375	25	51	10
21695-0310	63	1.000	1.686	0.312	25	43	8	21695-0301	63	1.000	2.000	0.375	25	51	10
21158-0310	63	1.000	1.686	0.313	25	43	8	29699-0007	GD	1.000	2.000	0.375	25	51	10
29507-5412	IG	1.000	1.687	0.625	25	43	16	21158-0302	63	1.000	2.000	0.438	25	51	11
26001-7055	71	1.000	1.750	0.250	25	44	6	24801-0627	EQUAL	1.000	2.000	0.500	25	51	13
21702-9808	62	1.000	1.750	0.313	25	44	8	29519-1083	IG	1.000	2.000	0.625	25	51	16
24600-1283	26	1.000	1.750	0.375	25	44	10	29619-1083	GD	1.000	2.000	0.625	25	51	16
24610-1283	26	1.000	1.750	0.375	25	44	10	24801-1083	EQUAL	1.000	2.000	0.625	25	51	16
24060-0293	61	1.000	1.750	0.375	25	44	10	24802-1083	EQUAL	1.000	2.000	0.625	25	51	16
24110-0293	61	1.000	1.750	0.375	25	44	10	29602-4138	GD	1.000	2.000	0.700	25	51	18
21702-0293	62	1.000	1.750	0.375	25	44	10	29502-4138	IG	1.000	2.000	0.750	25	51	19
21475-0293	63	1.000	1.750	0.375	25	44	10	29503-4138	IG	1.000	2.000	0.750	25	51	19

All dimensions are in inches. Preferred sizes are indicated with **bold** type face. Sizes listed are for standard nitrile elements, except Models 25 and 62 which have PTFE elements. Other material available on inquiry only.





## Oil Seals by Model Number

Product Code	Model	Inches			MM			Product Code	Model	Inches			MM		
		ID	OD	Width	ID	OD	Width			ID	OD	Width	ID	OD	Width
21528-0351	67	1.125	1.625	0.313	29	41	8	21159-0358	63	1.125	1.875	0.437	29	48	11
21923-0351	67	1.125	1.625	0.313	29	41	8	21158-0358	63	1.125	1.875	0.438	29	48	11
21951-0351	67	1.125	1.625	0.313	29	41	8	29507-5394	IG	1.125	1.875	0.625	29	48	16
24060-0352	61	1.125	1.625	0.375	29	41	10	29607-5394	GD	1.125	1.875	0.625	29	48	16
24125-0352	61	1.125	1.625	0.375	29	41	10	24802-1152	EQUAL	1.125	1.875	0.625	29	48	16
21158-0352	63	1.125	1.625	0.375	29	41	10	23550-6688	63T2	1.125	1.875	0.687	29	48	17
21163-0352	63	1.125	1.625	0.375	29	41	10	24807-2968	EQUAL	1.125	1.875	0.690	29	48	18
24062-1307	61	1.125	1.625	0.438	29	41	11	29602-4322	GD	1.125	1.875	0.700	29	48	18
24128-1307	61	1.125	1.625	0.438	29	41	11	29502-4322	IG	1.125	1.875	0.750	29	48	19
23548-6452	63R2	1.125	1.625	0.562	29	41	14	29507-1152	IG	1.125	1.876	0.625	29	48	16
23550-6452	63T2	1.125	1.625	0.562	29	41	14	21158-3872	63	1.125	1.984	0.375	29	50	10
23627-6452	63R2	1.125	1.625	0.563	29	41	14	21163-3872	63	1.125	1.984	0.375	29	50	10
29507-2273	IG	1.125	1.625	0.625	29	41	16	24600-1289	26	1.125	1.984	0.437	29	50	11
29607-2273	GD	1.125	1.625	0.625	29	41	16	21158-3873	63	1.125	1.984	0.437	29	50	11
24807-2273	EQUAL	1.125	1.625	0.625	29	41	16	24060-0359	61	1.125	2.000	0.375	29	51	10
24807-1352	EQUAL	1.125	1.625	0.690	29	41	18	21702-0359	62	1.125	2.000	0.375	29	51	10
24807-2829	EQUAL	1.125	1.625	0.690	29	41	18	21290-0359	63	1.125	2.000	0.375	29	51	10
21158-8066	63	1.125	1.654	0.313	29	42	8	21158-0359	63	1.125	2.000	0.375	29	51	10
24614-3472	26	1.125	1.750	0.313	29	44	8	21695-0359	63	1.125	2.000	0.375	29	51	10
25058-0353	25	1.125	1.750	0.375	29	44	10	27223-0359	94	1.125	2.000	0.375	29	51	10
24614-0353	26	1.125	1.750	0.375	29	44	10	21160-0360	63	1.125	2.000	0.438	29	51	11
24600-0353	26	1.125	1.750	0.375	29	44	10	21158-0360	63	1.125	2.000	0.438	29	51	11
24060-0353	61	1.125	1.750	0.375	29	44	10	21528-0360	67	1.125	2.000	0.438	29	51	11
21702-0353	62	1.125	1.750	0.375	29	44	10	23501-9180	63G1	1.125	2.000	0.500	29	51	13
21290-0353	63	1.125	1.750	0.375	29	44	10	29505-1395	IG	1.125	2.000	0.500	29	51	13
21159-0353	63	1.125	1.750	0.375	29	44	10	24820-0765	EQUAL	1.125	2.000	0.500	29	51	13
21158-0353	63	1.125	1.750	0.375	29	44	10	24856-0765	EQUAL	1.125	2.000	0.500	29	51	13
21695-0353	63	1.125	1.750	0.375	29	44	10	29507-0988	IG	1.125	2.000	0.625	29	51	16
21527-0353	66	1.125	1.750	0.375	29	44	10	29519-0988	IG	1.125	2.000	0.625	29	51	16
21528-0353	67	1.125	1.750	0.375	29	44	10	29619-7391	GD	1.125	2.000	0.625	29	51	16
21158-0354	63	1.125	1.750	0.437	29	44	11	24801-0988	EQUAL	1.125	2.000	0.625	29	51	16
29507-4184	IG	1.125	1.750	0.625	29	44	16	24806-0988	EQUAL	1.125	2.000	0.625	29	51	16
29607-4184	GD	1.125	1.750	0.625	29	44	16	24819-0988	EQUAL	1.125	2.000	0.625	29	51	16
23547-6857	63R1	1.125	1.750	0.688	29	44	17	24835-0988	EQUAL	1.125	2.000	0.625	29	51	16
23550-6857	63T2	1.125	1.750	0.688	29	44	17	24836-3328	EQUAL	1.125	2.000	0.670	29	51	17
24807-2994	EQUAL	1.125	1.750	0.690	29	44	18	23550-6466	63T2	1.125	2.000	0.688	29	51	17
24807-3877	EQUAL	1.125	1.801	0.690	29	46	18	29602-0000	GD	1.125	2.000	0.700	29	51	18
24600-1288	26	1.125	1.828	0.375	29	46	10	29602-4108	GD	1.125	2.000	0.700	29	51	18
21158-0355	63	1.125	1.828	0.375	29	46	10	29610-4108	GD	1.125	2.000	0.700	29	51	18
21158-0356	63	1.125	1.828	0.438	29	46	11	29500-4108	IG	1.125	2.000	0.750	29	51	19
21158-7650	63	1.125	1.850	0.313	29	47	8	29502-4108	IG	1.125	2.000	0.750	29	51	19
21542-7650	63	1.125	1.850	0.313	29	47	8	29503-4108	IG	1.125	2.000	0.750	29	51	19
29507-6125	IG	1.125	1.850	0.625	29	47	16	29526-4108	IG	1.125	2.000	0.750	29	51	19
21158-5891	63	1.125	1.851	0.437	29	47	11	24600-0842	26	1.125	2.001	0.375	29	51	10
29507-4840	IG	1.125	1.855	0.625	29	47	16	24801-0765	EQUAL	1.125	2.001	0.500	29	51	13
24831-5209	EQUAL	1.125	1.875	0.350	29	48	9	24802-0765	EQUAL	1.125	2.001	0.500	29	51	13
24600-1394	26	1.125	1.875	0.375	29	48	10	24802-0988	EQUAL	1.125	2.001	0.625	29	51	16
24610-1394	26	1.125	1.875	0.375	29	48	10	24822-0988	EQUAL	1.125	2.001	0.625	29	51	16
24062-0357	61	1.125	1.875	0.375	29	48	10	24802-5371	EQUAL	1.125	2.043	0.625	29	52	16
24060-0357	61	1.125	1.875	0.375	29	48	10	21158-8067	63	1.125	2.047	0.375	29	52	10
21767-0357	62	1.125	1.875	0.375	29	48	10	29502-5071	IG	1.125	2.050	0.750	29	52	19
21702-0357	62	1.125	1.875	0.375	29	48	10	24600-0814	26	1.125	2.062	0.375	29	52	10
21475-0357	63	1.125	1.875	0.375	29	48	10	21159-0361	63	1.125	2.062	0.375	29	52	10
21158-0357	63	1.125	1.875	0.375	29	48	10	21158-0361	63	1.125	2.062	0.375	29	52	10
21695-0357	63	1.125	1.875	0.375	29	48	10	21695-0361	63	1.125	2.062	0.375	29	52	10
21528-0357	67	1.125	1.875	0.375	29	48	10	21993-0361	67	1.125	2.062	0.375	29	52	10

All dimensions are in inches. Preferred sizes are indicated with **bold** type face. Sizes listed are for standard nitrile elements, except Models 25 and 62 which have PTFE elements. Other material available on inquiry only.

## Oil Seals by Model Number

Product Code	Model	Inches			MM			Product Code	Model	Inches			MM		
		ID	OD	Width	ID	OD	Width			ID	OD	Width	ID	OD	Width
21528-0361	67	1.125	2.062	0.375	29	52	10	21158-0377	63	1.156	2.250	0.375	29	57	10
21378-0361	68	1.125	2.062	0.375	29	52	10	21159-0380	63	1.156	2.375	0.375	29	60	10
29609-0814	GD	1.125	2.062	0.375	29	52	10	21158-0380	63	1.156	2.375	0.375	29	60	10
21158-0362	63	1.125	2.062	0.437	29	52	11	21158-3875	63	1.156	2.441	0.375	29	62	10
21695-0362	63	1.125	2.062	0.437	29	52	11	27223-6738	94	1.156	2.835	0.375	29	72	10
24801-1920	EQUAL	1.125	2.062	0.625	29	52	16	24802-3772	EQUAL	1.161	2.000	0.625	29	51	16
29502-5470	IG	1.125	2.062	0.750	29	52	19	29602-6765	GD	1.166	2.166	0.700	30	55	18
24831-5208	EQUAL	1.125	2.125	0.350	29	54	9	29502-5511	IG	1.168	2.437	0.750	30	62	19
21527-7242	66	1.125	2.125	0.375	29	54	10	29502-5526	IG	1.171	2.250	0.750	30	57	19
24801-0832	EQUAL	1.125	2.125	0.625	29	54	16	29502-4720	IG	1.173	2.441	0.750	30	62	19
24802-0832	EQUAL	1.125	2.125	0.625	29	54	16	24802-4341	EQUAL	1.177	2.441	0.625	30	62	16
29602-4139	GD	1.125	2.125	0.700	29	54	18	24802-4342	EQUAL	1.177	2.500	0.625	30	64	16
29502-4139	IG	1.125	2.125	0.750	29	54	19	29519-6165	IG	1.180	2.000	0.625	30	51	16
24802-4415	EQUAL	1.125	2.188	0.625	29	56	16	29602-5149	GD	1.180	2.000	0.700	30	51	18
24801-0815	EQUAL	1.125	2.250	0.625	29	57	16	29502-5149	IG	1.180	2.000	0.750	30	51	19
24802-0815	EQUAL	1.125	2.250	0.625	29	57	16	24849-3976	EQUAL	1.180	2.056	0.625	30	52	16
29502-6507	IG	1.125	2.250	0.750	29	57	19	29505-5764	IG	1.180	2.180	0.500	30	55	13
29502-5039	IG	1.125	2.375	0.750	29	60	19	29502-5166	IG	1.180	2.180	0.750	30	55	19
24802-5573	EQUAL	1.125	2.437	0.625	29	62	16	29500-6490	IG	1.180	2.250	0.750	30	57	19
27223-6176	94	1.125	2.441	0.375	29	62	10	29502-6490	IG	1.180	2.250	0.750	30	57	19
29519-2859	IG	1.125	2.441	0.625	29	62	16	24805-2959	EQUAL	1.180	2.370	0.625	30	60	16
24802-2859	EQUAL	1.125	2.441	0.625	29	62	16	29502-4422	IG	1.180	2.835	0.750	30	72	19
29602-4181	GD	1.125	2.441	0.700	29	62	18	29507-1221	IG	1.181	1.556	0.625	30	40	16
29500-4181	IG	1.125	2.441	0.750	29	62	19	24125-3267	61	1.181	1.575	0.438	30	40	11
29502-4181	IG	1.125	2.441	0.750	29	62	19	24076-3267	61	1.181	1.575	0.438	30	40	11
29507-7323	IG	1.125	2.625	0.625	29	67	16	24063-3267	61	1.181	1.575	0.438	30	40	11
29502-7323	IG	1.125	2.625	0.750	29	67	19	29507-4918	IG	1.181	1.575	0.625	30	40	16
24650-3885	26NS	1.125	2.750	0.375	29	70	10	29507-6778	IG	1.181	1.625	0.625	30	41	16
24600-3885	26	1.125	2.750	0.375	29	70	10	24807-2806	EQUAL	1.181	1.625	0.690	30	41	18
24811-4419	EQUAL	1.125	2.750	0.625	29	70	16	29507-4920	IG	1.181	1.654	0.625	30	42	16
24600-1290	26	1.125	2.844	0.500	29	72	13	29507-5204	IG	1.181	1.772	0.625	30	45	16
24831-3167	EQUAL	1.125	3.087	0.550	29	78	14	29507-6934	IG	1.181	1.811	0.625	30	46	16
24802-1091	EQUAL	1.125	3.150	0.625	29	80	16	24060-9342	61	1.181	1.850	0.375	30	47	10
29502-4402	IG	1.127	2.000	0.750	29	51	19	24064-9342	61	1.181	1.850	0.375	30	47	10
29502-6520	IG	1.134	2.008	0.750	29	51	19	24125-9342	61	1.181	1.850	0.375	30	47	10
24060-2218	61	1.142	1.575	0.250	29	40	6	21158-9342	63	1.181	1.850	0.375	30	47	10
29502-6394	IG	1.142	2.142	0.750	29	54	19	21695-9342	63	1.181	1.850	0.375	30	47	10
29502-5517	IG	1.145	2.000	0.750	29	51	19	29507-4919	IG	1.181	1.850	0.625	30	47	16
29619-6995	GD	1.150	2.000	0.625	29	51	16	24807-3638	EQUAL	1.181	1.850	0.690	30	47	18
21158-0363	63	1.156	1.875	0.375	29	48	10	24629-0379	26R1	1.181	1.968	0.434	30	50	11
21695-0363	63	1.156	1.875	0.375	29	48	10	24600-0378	26	1.181	1.969	0.276	30	50	7
21959-0363	67	1.156	1.875	0.375	29	48	10	29502-5599	IG	1.181	1.969	0.750	30	50	19
21528-0363	67	1.156	1.875	0.375	29	48	10	24801-5446	EQUAL	1.181	2.030	0.625	30	52	16
29507-5112	IG	1.156	1.875	0.625	29	48	16	24062-3531	61	1.181	2.047	0.438	30	52	11
24807-1025	EQUAL	1.156	1.875	0.690	29	48	18	29502-6442	IG	1.181	2.165	0.750	30	55	19
21158-0365	63	1.156	1.984	0.375	29	50	10	29507-3388	IG	1.181	2.181	0.625	30	55	16
21158-0367	63	1.156	2.000	0.375	29	51	10	24802-3388	EQUAL	1.181	2.181	0.625	30	55	16
29507-5812	IG	1.156	2.000	0.625	29	51	16	29502-6225	IG	1.181	2.205	0.750	30	56	19
24807-5797	EQUAL	1.156	2.000	0.690	29	51	18	24802-1499	EQUAL	1.181	2.211	0.625	30	56	16
21158-7914	63	1.156	2.047	0.375	29	52	10	24802-2476	EQUAL	1.181	2.350	0.625	30	60	16
21158-0369	63	1.156	2.062	0.375	29	52	10	24802-1199	EQUAL	1.181	2.358	0.625	30	60	16
21158-0370	63	1.156	2.063	0.438	29	52	11	24801-1122	EQUAL	1.181	2.362	0.500	30	60	13
21158-0372	63	1.156	2.106	0.437	29	53	11	29507-6132	IG	1.181	2.362	0.625	30	60	16
21158-0374	63	1.156	2.125	0.375	29	54	10	29502-4684	IG	1.181	2.362	0.750	30	60	19
21695-0374	63	1.156	2.125	0.375	29	54	10	29519-3581	IG	1.181	2.441	0.625	30	62	16
21159-0377	63	1.156	2.250	0.375	29	57	10	29502-5584	IG	1.181	2.441	0.750	30	62	19

All dimensions are in inches. Preferred sizes are indicated with **bold** type face.

Sizes listed are for standard nitrile elements, except Models 25 and 62 which have PTFE elements. Other material available on inquiry only.

**Oil Seals by Model Number**

Product Code	Model	Inches			MM			Product Code	Model	Inches			MM		
		ID	OD	Width	ID	OD	Width			ID	OD	Width	ID	OD	Width
24801-1084	EQUAL	1.181	2.875	0.500	30	73	13	21702-3877	62	1.188	2.048	0.375	30	52	10
29502-6718	IG	1.181	2.875	0.750	30	73	19	21158-3877	63	1.188	2.048	0.375	30	52	10
29500-6019	IG	1.181	2.992	0.750	30	76	19	21527-3877	66	1.188	2.048	0.375	30	52	10
24060-0320	61	1.181	1.850	0.276	30	47	7	29502-6850	IG	1.188	2.048	0.750	30	52	19
24620-0379	26R1	1.181	1.969	0.433	30	50	11	21290-0389	63	1.188	2.062	0.375	30	52	10
24060-2803	61	1.181	2.047	0.394	30	52	10	21159-0389	63	1.188	2.062	0.375	30	52	10
24060-0312	61	1.182	1.575	0.276	30	40	7	21158-0389	63	1.188	2.062	0.375	30	52	10
24060-1763	61	1.182	1.653	0.315	30	42	8	21481-0389	66	1.188	2.062	0.375	30	52	10
29520-6316	IG	1.182	1.932	0.750	30	49	19	21702-0390	62	1.188	2.062	0.438	30	52	11
24802-2857	EQUAL	1.185	2.442	0.625	30	62	16	21158-0390	63	1.188	2.062	0.438	30	52	11
29502-4336	IG	1.185	2.442	0.750	30	62	19	21158-0394	63	1.188	2.125	0.375	30	54	10
26001-7061	71	1.187	1.437	0.125	30	36	3	21795-0394	63	1.188	2.125	0.375	30	54	10
21158-0384	63	1.187	1.875	0.437	30	48	11	21527-0394	66	1.188	2.125	0.375	30	54	10
21158-0386	63	1.187	1.984	0.437	30	50	11	29502-4272	IG	1.188	2.188	0.750	30	56	19
24600-1431	26	1.187	2.250	0.500	30	57	13	21158-0397	63	1.188	2.250	0.375	30	57	10
24802-5434	EQUAL	1.187	2.437	0.625	30	62	16	21168-0397	63	1.188	2.250	0.375	30	57	10
29502-5007	IG	1.187	2.437	0.750	30	62	19	21158-0399	63	1.188	2.250	0.500	30	57	13
27023-6279	91	1.188	1.625	0.250	30	41	6	29500-4538	IG	1.188	2.250	0.750	30	57	19
29507-6783	IG	1.188	1.687	0.625	30	43	16	29502-4538	IG	1.188	2.250	0.750	30	57	19
29606-6783	GD	1.188	1.687	0.625	30	43	16	24802-4653	EQUAL	1.188	2.358	0.625	30	60	16
24060-1319	61	1.188	1.750	0.312	30	44	8	24600-1432	26	1.188	2.360	0.250	30	60	6
24060-2334	61	1.188	1.750	0.375	30	44	10	21159-0400	63	1.188	2.375	0.375	30	60	10
29507-6515	IG	1.188	1.752	0.625	30	45	16	21158-0400	63	1.188	2.375	0.375	30	60	10
24614-1426	26	1.188	1.813	0.313	30	46	8	21158-0402	63	1.188	2.375	0.500	30	60	13
21158-3876	63	1.188	1.828	0.375	30	46	10	24620-4620	26R1	1.188	2.441	0.375	30	62	10
21919-3876	63	1.188	1.828	0.375	30	46	10	21695-4600	63	1.188	2.441	0.375	30	62	10
21695-3876	63	1.188	1.828	0.375	30	46	10	27223-4600	94	1.188	2.441	0.375	30	62	10
21475-6659	63	1.188	1.850	0.375	30	47	10	24802-1850	EQUAL	1.188	2.441	0.625	30	62	16
21158-6659	63	1.188	1.850	0.375	30	47	10	24620-4549	26R1	1.188	2.835	0.375	30	72	10
21795-6659	63	1.188	1.850	0.375	30	47	10	21158-4597	63	1.188	2.835	0.375	30	72	10
24600-0383	26	1.188	1.875	0.375	30	48	10	29519-7527	IG	1.190	2.250	0.625	30	57	16
21290-0383	63	1.188	1.875	0.375	30	48	10	29502-5148	IG	1.200	2.000	0.750	30	51	19
21159-0383	63	1.188	1.875	0.375	30	48	10	26001-2131	71	1.218	1.625	0.187	31	41	5
21475-0383	63	1.188	1.875	0.375	30	48	10	21159-0403	63	1.219	1.984	0.375	31	50	10
21158-0383	63	1.188	1.875	0.375	30	48	10	21158-0403	63	1.219	1.984	0.375	31	50	10
21177-0383	63	1.188	1.875	0.375	30	48	10	21158-0405	63	1.219	2.000	0.375	31	51	10
21919-0383	63	1.188	1.875	0.375	30	48	10	21695-8068	63	1.219	2.047	0.375	31	52	10
21695-0383	63	1.188	1.875	0.375	30	48	10	21158-0415	63	1.219	2.250	0.375	31	57	10
23548-8187	63R2	1.188	1.875	0.688	30	48	17	21158-0421	63	1.219	2.437	0.375	31	62	10
23550-8187	63T2	1.188	1.875	0.688	30	48	17	24062-3815	61	1.220	2.047	0.438	31	52	11
24610-1292	26	1.188	1.938	0.375	30	49	10	24801-2698	EQUAL	1.235	2.000	0.625	31	51	16
29519-6550	IG	1.188	1.938	0.625	30	49	16	24802-2698	EQUAL	1.235	2.000	0.625	31	51	16
21702-0385	62	1.188	1.984	0.375	30	50	10	29502-5689	IG	1.241	2.253	0.750	32	57	19
21158-0385	63	1.188	1.984	0.375	30	50	10	26001-7062	71	1.250	1.500	0.125	32	38	3
21695-0385	63	1.188	1.984	0.375	30	50	10	27769-6183	76	1.250	1.625	0.188	32	41	5
21158-0387	63	1.188	2.000	0.375	30	51	10	26193-6183	76	1.250	1.625	0.188	32	41	5
21695-0387	63	1.188	2.000	0.375	30	51	10	29507-3534	IG	1.250	1.687	0.625	32	43	16
21481-0387	66	1.188	2.000	0.375	30	51	10	29607-3534	GD	1.250	1.687	0.625	32	43	16
21527-0387	66	1.188	2.000	0.375	30	51	10	26193-7516	76	1.250	1.688	0.188	32	43	5
21158-0388	63	1.188	2.000	0.438	30	51	11	24807-3534	EQUAL	1.250	1.688	0.625	32	43	16
21695-0388	63	1.188	2.000	0.438	30	51	11	24807-3622	EQUAL	1.250	1.688	0.690	32	43	18
24610-3723	26	1.188	2.000	0.500	30	51	13	24635-5239	26	1.250	1.750	0.250	32	44	6
23078-6993	63F1	1.188	2.000	0.594	30	51	15	24626-5239	26	1.250	1.750	0.250	32	44	6
29507-6065	IG	1.188	2.000	0.625	30	51	16	24600-5239	26	1.250	1.750	0.250	32	44	6
29500-4559	IG	1.188	2.000	0.750	30	51	19	24060-5239	61	1.250	1.750	0.250	32	44	6
29502-4559	IG	1.188	2.000	0.750	30	51	19	26001-5239	71	1.250	1.750	0.250	32	44	6

All dimensions are in inches. Preferred sizes are indicated with **bold** type face. Sizes listed are for standard nitrile elements, except Models 25 and 62 which have PTFE elements. Other material available on inquiry only.

## Oil Seals by Model Number

Product Code	Model	Inches			MM			Product Code	Model	Inches			MM		
		ID	OD	Width	ID	OD	Width			ID	OD	Width	ID	OD	Width
24125-8887	61	1.250	1.750	0.375	32	44	10	23548-6745	63R2	1.250	2.000	0.688	32	51	17
24060-8887	61	1.250	1.750	0.375	32	44	10	23627-6745	63R2	1.250	2.000	0.688	32	51	17
24064-8887	61	1.250	1.750	0.375	32	44	10	23550-6745	63T2	1.250	2.000	0.688	32	51	17
21518-8887	66	1.250	1.750	0.375	32	44	10	29602-4185	GD	1.250	2.000	0.700	32	51	18
29507-4340	IG	1.250	1.750	0.625	32	44	16	29502-4185	IG	1.250	2.000	0.750	32	51	19
29607-4340	GD	1.250	1.750	0.625	32	44	16	21158-7852	63	1.250	2.048	0.375	32	52	10
24807-1782	EQUAL	1.250	1.750	0.690	32	44	18	21158-0430	63	1.250	2.062	0.375	32	52	10
29606-7305	GD	1.250	1.752	0.625	32	45	16	21158-0431	63	1.250	2.062	0.437	32	52	11
24614-2880	26	1.250	1.875	0.312	32	48	8	23550-6624	63T2	1.250	2.062	0.688	32	52	17
24060-1337	61	1.250	1.875	0.312	32	48	8	21158-0433	63	1.250	2.106	0.375	32	53	10
24649-2880	26	1.250	1.875	0.313	32	48	8	24600-1295	26	1.250	2.125	0.375	32	54	10
24060-5704	61	1.250	1.875	0.375	32	48	10	24060-0436	61	1.250	2.125	0.375	32	54	10
21290-5704	63	1.250	1.875	0.375	32	48	10	21158-0436	63	1.250	2.125	0.375	32	54	10
21158-5704	63	1.250	1.875	0.375	32	48	10	21163-0436	63	1.250	2.125	0.375	32	54	10
21518-5704	66	1.250	1.875	0.375	32	48	10	21695-0436	63	1.250	2.125	0.375	32	54	10
24062-3031	61	1.250	1.875	0.438	32	48	11	21158-0437	63	1.250	2.125	0.437	32	54	11
24062-3047	61	1.250	1.875	0.625	32	48	16	21158-0438	63	1.250	2.125	0.500	32	54	13
23550-1452	63T2	1.250	1.875	0.688	32	48	17	24801-1048	EQUAL	1.250	2.125	0.500	32	54	13
24807-2996	EQUAL	1.250	1.875	0.690	32	48	18	24801-1932	EQUAL	1.250	2.125	0.625	32	54	16
21702-0424	62	1.250	1.984	0.375	32	50	10	24802-1932	EQUAL	1.250	2.125	0.625	32	54	16
21294-0424	63	1.250	1.984	0.375	32	50	10	24812-1932	EQUAL	1.250	2.125	0.625	32	54	16
21158-0424	63	1.250	1.984	0.375	32	50	10	23547-6674	63R1	1.250	2.125	0.687	32	54	17
21695-0424	63	1.250	1.984	0.375	32	50	10	23549-6674	63TB	1.250	2.125	0.688	32	54	17
21527-0424	66	1.250	1.984	0.375	32	50	10	29502-6024	IG	1.250	2.125	0.750	32	54	19
21168-0424	63	1.250	1.984	0.437	32	50	11	24060-1344	61	1.250	2.250	0.312	32	57	8
21158-0425	63	1.250	1.984	0.437	32	50	11	24627-2468	26	1.250	2.250	0.375	32	57	10
21702-0425	62	1.250	1.984	0.438	32	50	11	24060-0439	61	1.250	2.250	0.375	32	57	10
21158-0426	63	1.250	1.984	0.500	32	50	13	21702-0439	62	1.250	2.250	0.375	32	57	10
23550-7595	63T2	1.250	1.984	0.688	32	50	17	21475-0439	63	1.250	2.250	0.375	32	57	10
29607-7246	GD	1.250	1.985	0.625	32	50	16	21158-0439	63	1.250	2.250	0.375	32	57	10
25058-0427	25	1.250	2.000	0.375	32	51	10	21795-0439	63	1.250	2.250	0.375	32	57	10
24626-2128	26	1.250	2.000	0.375	32	51	10	21158-0440	63	1.250	2.250	0.437	32	57	11
24600-2128	26	1.250	2.000	0.375	32	51	10	24650-0631	26NS	1.250	2.250	0.500	32	57	13
24064-0427	61	1.250	2.000	0.375	32	51	10	24626-0631	26	1.250	2.250	0.500	32	57	13
24060-0427	61	1.250	2.000	0.375	32	51	10	24683-0631	26	1.250	2.250	0.500	32	57	13
24110-0427	61	1.250	2.000	0.375	32	51	10	24600-0631	26	1.250	2.250	0.500	32	57	13
21767-0427	62	1.250	2.000	0.375	32	51	10	24060-0441	61	1.250	2.250	0.500	32	57	13
21702-0427	62	1.250	2.000	0.375	32	51	10	21158-0441	63	1.250	2.250	0.500	32	57	13
21159-0427	63	1.250	2.000	0.375	32	51	10	21695-0441	63	1.250	2.250	0.500	32	57	13
21158-0427	63	1.250	2.000	0.375	32	51	10	24801-1420	EQUAL	1.250	2.250	0.625	32	57	16
21372-0427	63	1.250	2.000	0.375	32	51	10	24802-1420	EQUAL	1.250	2.250	0.625	32	57	16
21893-0427	63	1.250	2.000	0.375	32	51	10	23547-6675	63R1	1.250	2.250	0.687	32	57	17
21168-0427	63	1.250	2.000	0.375	32	51	10	23548-6675	63R2	1.250	2.250	0.687	32	57	17
21695-0427	63	1.250	2.000	0.375	32	51	10	24807-3533	EQUAL	1.250	2.250	0.690	32	57	18
21476-0427	66	1.250	2.000	0.375	32	51	10	29602-4140	GD	1.250	2.250	0.700	32	57	18
21527-0427	66	1.250	2.000	0.375	32	51	10	29500-4140	IG	1.250	2.250	0.750	32	57	19
21959-0427	67	1.250	2.000	0.375	32	51	10	29502-4140	IG	1.250	2.250	0.750	32	57	19
21528-0427	67	1.250	2.000	0.375	32	51	10	21702-0442	62	1.250	2.375	0.375	32	60	10
21163-0428	63	1.250	2.000	0.437	32	51	11	21159-0442	63	1.250	2.375	0.375	32	60	10
21158-0428	63	1.250	2.000	0.438	32	51	11	21158-0442	63	1.250	2.375	0.375	32	60	10
24801-0798	EQUAL	1.250	2.000	0.500	32	51	13	21168-0442	63	1.250	2.375	0.375	32	60	10
24821-0798	EQUAL	1.250	2.000	0.500	32	51	13	21527-0442	66	1.250	2.375	0.375	32	60	10
29507-1215	IG	1.250	2.000	0.625	32	51	16	21158-0443	63	1.250	2.375	0.437	32	60	11
24801-1215	EQUAL	1.250	2.000	0.625	32	51	16	23078-7372	63F1	1.250	2.375	0.594	32	60	15
24802-1215	EQUAL	1.250	2.000	0.625	32	51	16	24801-0787	EQUAL	1.250	2.375	0.625	32	60	16
23547-6745	63R1	1.250	2.000	0.688	32	51	17	24802-0787	EQUAL	1.250	2.375	0.625	32	60	16

All dimensions are in inches. Preferred sizes are indicated with **bold** type face.

Sizes listed are for standard nitrile elements, except Models 25 and 62 which have PTFE elements. Other material available on inquiry only.

**Oil Seals by Model Number**

Product Code	Model	Inches			MM			Product Code	Model	Inches			MM		
		ID	OD	Width	ID	OD	Width			ID	OD	Width	ID	OD	Width
23548-6517	63R2	1.250	2.375	0.688	32	60	17	21159-0490	63	1.313	2.125	0.375	33	54	10
29501-4857	IG	1.250	2.375	0.750	32	60	19	21158-0490	63	1.313	2.125	0.375	33	54	10
21702-0445	62	1.250	2.437	0.375	32	62	10	21158-0491	63	1.313	2.125	0.438	33	54	11
21475-0445	63	1.250	2.437	0.375	32	62	10	21695-0491	63	1.313	2.125	0.438	33	54	11
21158-0445	63	1.250	2.437	0.375	32	62	10	21158-0493	63	1.313	2.250	0.375	33	57	10
21527-0445	66	1.250	2.437	0.375	32	62	10	21695-0493	63	1.313	2.250	0.375	33	57	10
21158-0446	63	1.250	2.437	0.438	32	62	11	21158-0495	63	1.313	2.250	0.500	33	57	13
24600-1296	26	1.250	2.438	0.438	32	62	11	21702-0496	62	1.313	2.375	0.375	33	60	10
29502-4680	IG	1.250	2.438	0.750	32	62	19	21158-0496	63	1.313	2.375	0.375	33	60	10
29609-6892	GD	1.250	2.500	0.375	32	64	10	21158-0498	63	1.313	2.375	0.500	33	60	13
29502-5947	IG	1.250	2.500	0.750	32	64	19	21158-8071	63	1.313	2.441	0.375	33	62	10
27223-6192	94	1.250	2.835	0.375	32	72	10	21158-0505	63	1.313	2.500	0.375	33	64	10
29502-6072	IG	1.250	2.839	0.750	32	72	19	21158-3879	63	1.313	2.875	0.500	33	73	13
24802-2195	EQUAL	1.250	2.875	0.625	32	73	16	24801-1019	EQUAL	1.334	2.363	0.500	34	60	13
29500-5684	IG	1.250	2.875	0.750	32	73	19	24801-1411	EQUAL	1.334	2.363	0.625	34	60	16
29502-5101	IG	1.250	2.875	0.750	32	73	19	24801-2411	EQUAL	1.334	2.363	0.625	34	60	16
29502-5621	IG	1.250	3.125	0.750	32	79	19	24802-1411	EQUAL	1.334	2.363	0.625	34	60	16
29502-5214	IG	1.250	3.150	0.750	32	80	19	29502-5615	IG	1.337	2.337	0.750	34	59	19
29697-0006	GD	1.256	2.062	0.900	32	52	23	29502-6396	IG	1.338	2.375	0.750	34	60	19
24812-4829	EQUAL	1.259	2.165	0.625	32	55	16	21158-0511	63	1.344	2.106	0.375	34	53	10
24056-1776	61	1.260	1.850	0.315	32	47	8	21702-0517	62	1.344	2.250	0.375	34	57	10
24060-1776	61	1.260	1.850	0.315	32	47	8	21158-0517	63	1.344	2.250	0.375	34	57	10
29519-4923	IG	1.260	2.047	0.626	32	52	16	21158-0523	63	1.344	2.437	0.375	34	62	10
24060-2784	61	1.260	2.126	0.394	32	54	10	24060-0525	61	1.344	2.437	0.500	34	62	13
29507-5536	IG	1.260	1.654	0.625	32	42	16	21158-0525	63	1.344	2.437	0.500	34	62	13
24060-2224	61	1.260	1.772	0.315	32	45	8	21158-8072	63	1.344	2.441	0.375	34	62	10
29507-4922	IG	1.260	1.850	0.625	32	47	16	21158-0529	63	1.344	2.500	0.375	34	64	10
24060-2212	61	1.260	2.047	0.354	32	52	9	21158-0532	63	1.344	2.625	0.375	34	67	10
29502-4860	IG	1.260	2.165	0.750	32	55	19	29602-6845	GD	1.352	2.352	0.700	34	60	18
21158-7316	63	1.266	2.048	0.375	32	52	10	29502-4689	IG	1.370	2.375	0.750	35	60	19
21158-0448	63	1.281	1.984	0.375	33	50	10	29602-5301	GD	1.371	2.371	0.700	35	60	18
24060-0451	61	1.281	2.000	0.375	33	51	10	29602-6503	GD	1.373	2.125	0.700	35	54	18
21158-0451	63	1.281	2.000	0.375	33	51	10	26001-7068	71	1.375	1.625	0.125	35	41	3
21158-0454	63	1.281	2.062	0.375	33	52	10	26193-7520	76	1.375	1.750	0.188	35	44	5
21158-0463	63	1.281	2.250	0.375	33	57	10	29507-5576	IG	1.375	1.750	0.625	35	44	16
21158-0475	63	1.281	2.500	0.375	33	64	10	24807-4078	EQUAL	1.375	1.750	0.690	35	44	18
24060-2978	61	1.299	1.969	0.394	33	50	10	24807-4378	EQUAL	1.375	1.750	0.813	35	44	21
24060-1784	61	1.300	1.772	0.315	33	45	8	24600-6207	26	1.375	1.875	0.250	35	48	6
21695-0478	63	1.312	1.984	0.375	33	50	10	27223-6208	94	1.375	1.875	0.313	35	48	8
21159-0481	63	1.312	2.000	0.375	33	51	10	21518-0618	66	1.375	1.875	0.375	35	48	10
21158-0482	63	1.312	2.000	0.437	33	51	11	29507-4176	IG	1.375	1.875	0.625	35	48	16
29507-1146	IG	1.312	2.000	0.625	33	51	16	29607-4176	GD	1.375	1.875	0.625	35	48	16
24060-0484	61	1.312	2.062	0.375	33	52	10	24807-2512	EQUAL	1.375	1.875	0.690	35	48	18
21695-0490	63	1.312	2.125	0.375	33	54	10	24612-1454	26	1.375	2.000	0.312	35	51	8
24060-0493	61	1.312	2.250	0.375	33	57	10	24060-1354	61	1.375	2.000	0.312	35	51	8
21158-0499	63	1.312	2.437	0.375	33	62	10	24649-1454	26	1.375	2.000	0.313	35	51	8
26193-6195	76	1.313	1.625	0.156	33	41	4	24614-1454	26	1.375	2.000	0.313	35	51	8
26193-7519	76	1.313	1.750	0.188	33	44	5	24600-1454	26	1.375	2.000	0.313	35	51	8
21158-0478	63	1.313	1.984	0.375	33	50	10	24064-7386	61	1.375	2.000	0.375	35	51	10
21290-0481	63	1.313	2.000	0.375	33	51	10	24060-7386	61	1.375	2.000	0.375	35	51	10
21158-0481	63	1.313	2.000	0.375	33	51	10	21702-7386	62	1.375	2.000	0.375	35	51	10
29607-1146	GD	1.313	2.000	0.625	33	51	16	21290-7386	63	1.375	2.000	0.375	35	51	10
24807-2524	EQUAL	1.313	2.000	0.690	33	51	18	21158-7386	63	1.375	2.000	0.375	35	51	10
21158-4821	63	1.313	2.048	0.375	33	52	10	23501-0857	63G1	1.375	2.000	0.500	35	51	13
21158-0484	63	1.313	2.062	0.375	33	52	10	29507-2940	IG	1.375	2.000	0.625	35	51	16
21158-0485	63	1.313	2.062	0.438	33	52	11	23769-6855	63R2	1.375	2.000	0.687	35	51	17

All dimensions are in inches. Preferred sizes are indicated with **bold** type face.  
 Sizes listed are for standard nitrile elements, except Models 25 and 62 which have PTFE elements. Other material available on inquiry only.

## Oil Seals by Model Number

Product Code	Model	Inches			MM			Product Code	Model	Inches			MM		
		ID	OD	Width	ID	OD	Width			ID	OD	Width	ID	OD	Width
24807-1970	EQUAL	1.375	2.000	0.690	35	51	18	24060-0544	61	1.375	2.250	0.375	35	57	10
21702-6655	62	1.375	2.047	0.375	35	52	10	21702-0544	62	1.375	2.250	0.375	35	57	10
21158-6655	63	1.375	2.047	0.375	35	52	10	21159-0544	63	1.375	2.250	0.375	35	57	10
21695-6655	63	1.375	2.047	0.375	35	52	10	21158-0544	63	1.375	2.250	0.375	35	57	10
24060-0535	61	1.375	2.062	0.375	35	52	10	21163-0544	63	1.375	2.250	0.375	35	57	10
21767-0535	62	1.375	2.062	0.375	35	52	10	21993-0544	67	1.375	2.250	0.375	35	57	10
21702-0535	62	1.375	2.062	0.375	35	52	10	21959-0544	67	1.375	2.250	0.375	35	57	10
21159-0535	63	1.375	2.062	0.375	35	52	10	21528-0544	67	1.375	2.250	0.375	35	57	10
21475-0535	63	1.375	2.062	0.375	35	52	10	21378-0544	68	1.375	2.250	0.375	35	57	10
21158-0535	63	1.375	2.062	0.375	35	52	10	21158-0545	63	1.375	2.250	0.438	35	57	11
21431-0535	63	1.375	2.062	0.375	35	52	10	21158-0546	63	1.375	2.250	0.500	35	57	13
21695-0535	63	1.375	2.062	0.375	35	52	10	24801-1008	EQUAL	1.375	2.250	0.500	35	57	13
21527-0535	66	1.375	2.062	0.375	35	52	10	24803-1008	EQUAL	1.375	2.250	0.500	35	57	13
21959-0535	67	1.375	2.062	0.375	35	52	10	24801-1121	EQUAL	1.375	2.250	0.625	35	57	16
21528-0535	67	1.375	2.062	0.375	35	52	10	24802-1121	EQUAL	1.375	2.250	0.625	35	57	16
21923-0535	67	1.375	2.062	0.375	35	52	10	23547-6774	63R1	1.375	2.250	0.688	35	57	17
21951-0535	67	1.375	2.062	0.375	35	52	10	29502-5520	IG	1.375	2.250	0.750	35	57	19
23547-6576	63R1	1.375	2.062	0.688	35	52	17	29507-5097	IG	1.375	2.263	0.625	35	57	16
23550-6576	63T2	1.375	2.062	0.688	35	52	17	24600-0547	26	1.375	2.375	0.375	35	60	10
24807-2692	EQUAL	1.375	2.062	0.690	35	52	18	21158-0547	63	1.375	2.375	0.375	35	60	10
29507-4318	IG	1.375	2.063	0.625	35	52	16	21695-0547	63	1.375	2.375	0.375	35	60	10
24600-0705	26	1.375	2.064	0.500	35	52	13	21702-0548	62	1.375	2.375	0.438	35	60	11
29507-4815	IG	1.375	2.103	0.625	35	53	16	21158-0548	63	1.375	2.375	0.438	35	60	11
21158-0538	63	1.375	2.106	0.375	35	53	10	24627-0633	26	1.375	2.375	0.500	35	60	13
21695-0538	63	1.375	2.106	0.375	35	53	10	21158-0549	63	1.375	2.375	0.500	35	60	13
21163-0539	63	1.375	2.106	0.437	35	53	11	29519-1101	IG	1.375	2.375	0.625	35	60	16
21158-0539	63	1.375	2.106	0.437	35	53	11	29619-1101	GD	1.375	2.375	0.625	35	60	16
23550-5007	63T2	1.375	2.106	0.687	35	53	17	24802-1101	EQUAL	1.375	2.375	0.625	35	60	16
24626-1829	26	1.375	2.125	0.375	35	54	10	24806-1101	EQUAL	1.375	2.375	0.625	35	60	16
24600-1829	26	1.375	2.125	0.375	35	54	10	29602-4141	GD	1.375	2.375	0.700	35	60	18
24610-1829	26	1.375	2.125	0.375	35	54	10	29500-4141	IG	1.375	2.375	0.750	35	60	19
21702-0541	62	1.375	2.125	0.375	35	54	10	29501-4141	IG	1.375	2.375	0.750	35	60	19
21173-0541	63	1.375	2.125	0.375	35	54	10	29502-4141	IG	1.375	2.375	0.750	35	60	19
21159-0541	63	1.375	2.125	0.375	35	54	10	29520-4141	IG	1.375	2.375	0.750	35	60	19
21158-0541	63	1.375	2.125	0.375	35	54	10	21173-0550	63	1.375	2.437	0.375	35	62	10
21542-0541	63	1.375	2.125	0.375	35	54	10	21158-0550	63	1.375	2.437	0.375	35	62	10
21695-0541	63	1.375	2.125	0.375	35	54	10	21695-0550	63	1.375	2.437	0.375	35	62	10
29609-1829	GD	1.375	2.125	0.375	35	54	10	21158-0551	63	1.375	2.437	0.437	35	62	11
21457-0542	63	1.375	2.125	0.437	35	54	11	21702-0552	62	1.375	2.437	0.500	35	62	13
21695-0542	63	1.375	2.125	0.437	35	54	11	24801-2694	EQUAL	1.375	2.437	0.625	35	62	16
21158-0542	63	1.375	2.125	0.438	35	54	11	24802-2694	EQUAL	1.375	2.437	0.625	35	62	16
21702-0543	62	1.375	2.125	0.500	35	54	13	24802-1929	EQUAL	1.375	2.438	0.625	35	62	16
21158-0543	63	1.375	2.125	0.500	35	54	13	29502-4320	IG	1.375	2.438	0.750	35	62	19
23078-9833	63F1	1.375	2.125	0.625	35	54	16	24600-0708	26	1.375	2.439	0.500	35	62	13
29507-1092	IG	1.375	2.125	0.625	35	54	16	24683-0708	26	1.375	2.439	0.500	35	62	13
29519-1092	IG	1.375	2.125	0.625	35	54	16	24602-0708	26	1.375	2.439	0.500	35	62	13
24801-1092	EQUAL	1.375	2.125	0.625	35	54	16	27223-5091	94	1.375	2.441	0.313	35	62	8
24802-1092	EQUAL	1.375	2.125	0.625	35	54	16	21290-6658	63	1.375	2.441	0.375	35	62	10
24819-1092	EQUAL	1.375	2.125	0.625	35	54	16	21695-6658	63	1.375	2.441	0.375	35	62	10
24824-1092	EQUAL	1.375	2.125	0.625	35	54	16	21527-6658	66	1.375	2.441	0.375	35	62	10
23547-6479	63R1	1.375	2.125	0.687	35	54	17	23501-3665	63G1	1.375	2.441	0.500	35	62	13
24807-2858	EQUAL	1.375	2.125	0.690	35	54	18	24060-4555	61	1.375	2.445	0.313	35	62	8
29602-4118	GD	1.375	2.125	0.700	35	54	18	21158-0553	63	1.375	2.497	0.375	35	63	10
29500-4118	IG	1.375	2.125	0.750	35	54	19	21158-0554	63	1.375	2.497	0.437	35	63	11
29502-4118	IG	1.375	2.125	0.750	35	54	19	21158-0555	63	1.375	2.497	0.500	35	63	13
25058-0544	25	1.375	2.250	0.375	35	57	10	24650-0556	26NS	1.375	2.500	0.375	35	64	10

All dimensions are in inches. Preferred sizes are indicated with **bold** type face.

Sizes listed are for standard nitrile elements, except Models 25 and 62 which have PTFE elements. Other material available on inquiry only.

## Oil Seals by Model Number

Product Code	Model	Inches			MM			Product Code	Model	Inches			MM		
		ID	OD	Width	ID	OD	Width			ID	OD	Width	ID	OD	Width
24600-0556	26	1.375	2.500	0.375	35	64	10	24060-1787	61	1.378	1.850	0.315	35	47	8
24060-0556	61	1.375	2.500	0.375	35	64	10	24620-0572	26R1	1.378	1.969	0.315	35	50	8
21159-0556	63	1.375	2.500	0.375	35	64	10	24602-1189	26	1.378	2.047	0.276	35	52	7
21158-0556	63	1.375	2.500	0.375	35	64	10	26193-0134	76	1.378	2.047	0.276	35	52	7
21431-0556	63	1.375	2.500	0.375	35	64	10	24060-0371	61	1.378	2.165	0.315	35	55	8
21500-0556	63	1.375	2.500	0.375	35	64	10	24600-0575	26	1.378	2.244	0.394	35	57	10
21695-0556	63	1.375	2.500	0.375	35	64	10	24064-1788	61	1.378	1.850	0.394	35	47	10
23501-2713	63G1	1.375	2.500	0.500	35	64	13	29507-4924	IG	1.378	1.850	0.625	35	47	16
24600-0754	26	1.375	2.500	0.625	35	64	16	24629-0572	26R1	1.378	1.969	0.315	35	50	8
24801-0754	EQUAL	1.375	2.500	0.625	35	64	16	24060-1789	61	1.378	1.969	0.394	35	50	10
24802-0754	EQUAL	1.375	2.500	0.625	35	64	16	24062-1789	61	1.378	1.969	0.394	35	50	10
23550-6475	63T2	1.375	2.500	0.688	35	64	17	24125-1789	61	1.378	1.969	0.394	35	50	10
29502-5334	IG	1.375	2.500	0.750	35	64	19	29507-4925	IG	1.378	1.969	0.625	35	50	16
21158-0562	63	1.375	2.561	0.375	35	65	10	29606-4925	GD	1.378	1.969	0.625	35	50	16
21003-2295	58	1.375	2.562	0.500	35	65	13	29507-6935	IG	1.378	2.008	0.625	35	51	16
21159-0559	63	1.375	2.625	0.375	35	67	10	24626-1139	26	1.378	2.047	0.276	35	52	7
21300-0559	63	1.375	2.625	0.375	35	67	10	24600-1139	26	1.378	2.047	0.276	35	52	7
21158-0559	63	1.375	2.625	0.375	35	67	10	29507-4926	IG	1.378	2.047	0.625	35	52	16
21695-0559	63	1.375	2.625	0.375	35	67	10	24637-0576	26	1.378	2.087	0.354	35	53	9
23550-4976	63T2	1.375	2.625	0.688	35	67	17	29519-6830	IG	1.378	2.128	0.625	35	54	16
29502-5024	IG	1.375	2.625	0.750	35	67	19	24801-2260	EQUAL	1.378	2.165	0.625	35	55	16
24600-1298	26	1.375	2.688	0.500	35	68	13	24802-2260	EQUAL	1.378	2.165	0.625	35	55	16
29502-5386	IG	1.375	2.812	0.750	35	71	19	24804-2260	EQUAL	1.378	2.165	0.625	35	55	16
24801-4639	EQUAL	1.375	2.828	0.625	35	72	16	29502-4529	IG	1.378	2.165	0.750	35	55	19
27223-6639	94	1.375	2.835	0.313	35	72	8	29516-7217	IG	1.378	2.343	0.725	35	60	18
21159-4584	63	1.375	2.835	0.375	35	72	10	24802-1752	EQUAL	1.378	2.362	0.625	35	60	16
21158-4584	63	1.375	2.835	0.375	35	72	10	29602-1752	GD	1.378	2.362	0.700	35	60	18
23501-0943	63G1	1.375	2.835	0.500	35	72	13	29602-6707	GD	1.378	2.378	0.700	35	60	18
24801-1138	EQUAL	1.375	2.835	0.625	35	72	16	24610-3046	26	1.378	2.441	0.500	35	62	13
24802-1138	EQUAL	1.375	2.835	0.625	35	72	16	24802-5917	EQUAL	1.378	2.441	0.625	35	62	16
24805-1138	EQUAL	1.375	2.835	0.625	35	72	16	24802-4096	EQUAL	1.378	2.545	0.625	35	65	16
24819-1138	EQUAL	1.375	2.835	0.625	35	72	16	24060-3976	61	1.378	2.559	0.315	35	65	8
24822-1138	EQUAL	1.375	2.835	0.625	35	72	16	29502-5798	IG	1.378	2.835	0.750	35	72	19
29602-4104	GD	1.375	2.835	0.700	35	72	18	24847-5202	EQUAL	1.378	2.836	0.690	35	72	18
29500-4104	IG	1.375	2.835	0.750	35	72	19	29602-6969	GD	1.378	3.149	0.700	35	80	18
29502-4104	IG	1.375	2.835	0.750	35	72	19	24802-3087	EQUAL	1.378	3.150	0.625	35	80	16
29503-4104	IG	1.375	2.835	0.750	35	72	19	24847-6079	EQUAL	1.378	3.228	0.690	35	82	18
24801-1017	EQUAL	1.375	2.836	0.500	35	72	13	24847-6338	EQUAL	1.378	3.350	0.690	35	85	18
24060-9612	61	1.375	2.875	0.375	35	73	10	24600-0913	26	1.378	3.465	0.500	35	88	13
21158-9612	63	1.375	2.875	0.375	35	73	10	24060-2460	61	1.399	2.292	0.315	36	58	8
24802-2622	EQUAL	1.375	2.875	0.625	35	73	16	21702-0565	62	1.406	2.125	0.375	36	54	10
29502-6295	IG	1.375	2.875	0.750	35	73	19	21158-0565	63	1.406	2.125	0.375	36	54	10
29602-6421	GD	1.375	2.960	0.700	35	75	18	21695-0565	63	1.406	2.125	0.375	36	54	10
29502-6421	IG	1.375	2.960	0.750	35	75	19	21158-0566	63	1.406	2.125	0.438	36	54	11
29502-6730	IG	1.375	3.062	0.750	35	78	19	21158-0568	63	1.406	2.250	0.375	36	57	10
24802-1105	EQUAL	1.375	3.125	0.625	35	79	16	21158-0571	63	1.406	2.375	0.375	36	60	10
29602-4329	GD	1.375	3.125	0.700	35	79	18	21158-0583	63	1.406	2.625	0.375	36	67	10
27223-6557	94	1.375	3.150	0.375	35	80	10	21158-7748	63	1.417	2.047	0.375	36	52	10
29502-5775	IG	1.375	3.150	0.750	35	80	19	29507-5552	IG	1.417	2.125	0.625	36	54	16
25056-0396	25	1.375	3.250	0.375	35	83	10	24060-2119	61	1.417	1.969	0.276	36	50	7
29602-4730	GD	1.375	3.625	0.700	35	92	18	24802-1100	EQUAL	1.427	2.500	0.625	36	64	16
29502-4730	IG	1.375	3.625	0.750	35	92	19	24820-4089	EQUAL	1.428	2.375	0.500	36	60	13
24831-3166	EQUAL	1.375	3.922	0.550	35	100	14	25058-0814	25	1.437	2.062	0.375	36	52	10
24060-0366	61	1.378	1.850	0.276	35	47	7	21159-0592	63	1.437	2.125	0.375	36	54	10
24125-1787	61	1.378	1.850	0.315	35	47	8	21168-0592	63	1.437	2.125	0.375	36	54	10
24056-1787	61	1.378	1.850	0.315	35	47	8	21158-0593	63	1.437	2.125	0.437	36	54	11

All dimensions are in inches. Preferred sizes are indicated with **bold** type face. Sizes listed are for standard nitrile elements, except Models 25 and 62 which have PTFE elements. Other material available on inquiry only.

## Oil Seals by Model Number

Product Code	Model	Inches			MM			Product Code	Model	Inches			MM		
		ID	OD	Width	ID	OD	Width			ID	OD	Width	ID	OD	Width
24802-4456	EQUAL	1.437	2.125	0.625	36	54	16	24801-1116	EQUAL	1.438	2.250	0.625	37	57	16
23550-9122	63T2	1.437	2.125	0.687	36	54	17	24824-2850	EQUAL	1.438	2.250	0.625	37	57	16
24610-0592	26	1.437	2.188	0.375	36	56	10	29602-4117	GD	1.438	2.250	0.700	37	57	18
24610-1468	26	1.437	2.188	0.375	36	56	10	29502-6602	IG	1.438	2.300	0.750	37	58	19
21702-0597	62	1.437	2.250	0.500	36	57	13	24600-0598	26	1.438	2.375	0.375	37	60	10
21158-0597	63	1.437	2.250	0.500	36	57	13	24602-0598	26	1.438	2.375	0.375	37	60	10
24802-1116	EQUAL	1.437	2.250	0.625	36	57	16	24060-0598	61	1.438	2.375	0.375	37	60	10
24819-1116	EQUAL	1.437	2.250	0.625	36	57	16	21158-0598	63	1.438	2.375	0.375	37	60	10
29502-4117	IG	1.437	2.250	0.750	36	57	19	24610-1897	26	1.438	2.375	0.500	37	60	13
24802-3002	EQUAL	1.437	2.310	0.625	36	59	16	21702-0600	62	1.438	2.375	0.500	37	60	13
21702-0598	62	1.437	2.375	0.375	36	60	10	21158-0600	63	1.438	2.375	0.500	37	60	13
21542-0598	63	1.437	2.375	0.375	36	60	10	24820-1897	EQUAL	1.438	2.375	0.500	37	60	13
21158-0599	63	1.437	2.375	0.437	36	60	11	29507-1958	IG	1.438	2.375	0.625	37	60	16
21158-0603	63	1.437	2.437	0.500	36	62	13	24802-1958	EQUAL	1.438	2.375	0.625	37	60	16
24801-2720	EQUAL	1.437	2.437	0.625	36	62	16	29502-5489	IG	1.438	2.375	0.750	37	60	19
24829-2720	EQUAL	1.437	2.437	0.625	36	62	16	21158-0601	63	1.438	2.437	0.375	37	62	10
29602-4177	GD	1.437	2.437	0.700	36	62	18	24600-0634	26	1.438	2.438	0.500	37	62	13
29502-4177	IG	1.437	2.437	0.750	36	62	19	24610-0634	26	1.438	2.438	0.500	37	62	13
21158-0608	63	1.437	2.500	0.437	36	64	11	29507-2720	IG	1.438	2.438	0.625	37	62	16
24600-0609	26	1.437	2.500	0.500	36	64	13	24802-2720	EQUAL	1.438	2.438	0.625	37	62	16
21158-0609	63	1.437	2.500	0.500	36	64	13	29507-6460	IG	1.438	2.471	0.625	37	63	16
24802-2107	EQUAL	1.437	2.500	0.625	36	64	16	21158-0607	63	1.438	2.500	0.375	37	64	10
24850-2107	EQUAL	1.437	2.500	0.625	36	64	16	24851-2107	EQUAL	1.438	2.500	0.625	37	64	16
29502-5268	IG	1.437	2.694	0.750	36	68	19	29502-5436	IG	1.438	2.500	0.750	37	64	19
26001-7070	71	1.438	1.750	0.156	37	44	4	21695-0610	63	1.438	2.625	0.375	37	67	10
27223-6211	94	1.438	1.938	0.250	37	49	6	21158-0610	63	1.438	2.625	0.375	37	67	10
24060-2335	61	1.438	1.938	0.375	37	49	10	24829-4034	EQUAL	1.438	2.625	0.625	37	67	16
29507-5624	IG	1.438	1.938	0.625	37	49	16	21158-0613	63	1.438	2.686	0.375	37	68	10
24807-1783	EQUAL	1.438	1.938	0.690	37	49	18	29502-5968	IG	1.438	2.727	0.750	37	69	19
24626-1465	26	1.438	2.000	0.313	37	51	8	29502-4742	IG	1.450	2.360	0.750	37	60	19
24600-1465	26	1.438	2.000	0.313	37	51	8	26193-0920	76	1.457	1.654	0.157	37	42	4
24807-3110	EQUAL	1.438	2.062	0.690	37	52	18	26193-0136	76	1.457	1.732	0.197	37	44	5
24060-1361	61	1.438	2.063	0.312	37	52	8	29502-4440	IG	1.457	2.500	0.750	37	64	19
24600-1466	26	1.438	2.063	0.313	37	52	8	29502-6832	IG	1.457	2.677	0.750	37	68	19
24816-7124	EQUAL	1.438	2.063	0.778	37	52	20	24062-2991	61	1.458	2.125	0.438	37	54	11
24816-3982	EQUAL	1.438	2.063	0.875	37	52	22	24063-2991	61	1.458	2.125	0.438	37	54	11
29516-5432	IG	1.438	2.063	0.943	37	52	24	24802-1139	EQUAL	1.465	2.344	0.625	37	60	16
24816-7067	EQUAL	1.438	2.063	0.975	37	52	25	29502-5596	IG	1.468	2.375	0.750	37	60	19
29616-5432	GD	1.438	2.063	1.175	37	52	30	21159-0616	63	1.469	2.250	0.375	37	57	10
24626-0737	26	1.438	2.125	0.375	37	54	10	21158-0616	63	1.469	2.250	0.375	37	57	10
24600-0737	26	1.438	2.125	0.375	37	54	10	24807-3144	EQUAL	1.469	2.344	0.690	37	60	18
24060-0592	61	1.438	2.125	0.375	37	54	10	21158-0619	63	1.469	2.375	0.375	37	60	10
21158-0592	63	1.438	2.125	0.375	37	54	10	21158-0621	63	1.469	2.375	0.500	37	60	13
27223-0592	94	1.438	2.125	0.375	37	54	10	24802-4685	EQUAL	1.469	2.375	0.625	37	60	16
29507-4456	IG	1.438	2.125	0.625	37	54	16	21158-0622	63	1.469	2.437	0.375	37	62	10
29607-4456	GD	1.438	2.125	0.625	37	54	16	21158-0628	63	1.469	2.500	0.375	37	64	10
24807-1888	EQUAL	1.438	2.125	0.690	37	54	18	21158-4398	63	1.469	2.625	0.375	37	67	10
24060-1362	61	1.438	2.188	0.375	37	56	10	21158-0634	63	1.469	2.686	0.375	37	68	10
21003-0595	58	1.438	2.250	0.375	37	57	10	21158-0638	63	1.469	2.750	0.437	37	70	11
24060-0595	61	1.438	2.250	0.375	37	57	10	29502-1271	IG	1.474	2.375	0.750	37	60	19
21475-0595	63	1.438	2.250	0.375	37	57	10	24802-2288	EQUAL	1.475	2.335	0.625	37	59	16
21160-0595	63	1.438	2.250	0.375	37	57	10	29502-6045	IG	1.475	2.430	0.750	37	62	19
21158-0595	63	1.438	2.250	0.375	37	57	10	24802-3284	EQUAL	1.493	2.493	0.625	38	63	16
21695-0595	63	1.438	2.250	0.375	37	57	10	24060-1794	61	1.496	2.125	0.394	38	54	10
24600-0741	26	1.438	2.250	0.500	37	57	13	29609-6745	GD	1.496	2.165	0.375	38	55	10
24801-0741	EQUAL	1.438	2.250	0.500	37	57	13	29507-4934	IG	1.496	2.165	0.625	38	55	16

All dimensions are in inches. Preferred sizes are indicated with **bold** type face. Sizes listed are for standard nitrile elements, except Models 25 and 62 which have PTFE elements. Other material available on inquiry only.



## Oil Seals by Model Number

Product Code	Model	Inches			MM			Product Code	Model	Inches			MM		
		ID	OD	Width	ID	OD	Width			ID	OD	Width	ID	OD	Width
29607-4934	GD	1.496	2.165	0.625	38	55	16	24610-0644	26	1.500	2.250	0.437	38	57	11
24807-2839	EQUAL	1.496	2.165	0.690	38	55	18	24600-0644	26	1.500	2.250	0.438	38	57	11
29607-6958	GD	1.496	2.265	0.625	38	58	16	21158-0644	63	1.500	2.250	0.438	38	57	11
29502-5372	IG	1.496	2.362	0.750	38	60	19	21003-3866	58	1.500	2.250	0.468	38	57	12
24802-4935	EQUAL	1.496	2.441	0.625	38	62	16	24062-0645	61	1.500	2.250	0.500	38	57	13
24802-4102	EQUAL	1.496	2.496	0.625	38	63	16	24063-0645	61	1.500	2.250	0.500	38	57	13
24060-3978	61	1.496	3.150	0.315	38	80	8	21702-0645	62	1.500	2.250	0.500	38	57	13
24626-5409	26	1.496	2.246	0.374	38	57	10	21793-0645	63	1.500	2.250	0.500	38	57	13
24060-1792	61	1.496	2.362	0.394	38	60	10	21160-0645	63	1.500	2.250	0.500	38	57	13
26193-0132	76	1.496	2.441	0.315	38	62	8	21158-0645	63	1.500	2.250	0.500	38	57	13
29607-6502	GD	1.498	2.125	0.625	38	54	16	24801-0804	EQUAL	1.500	2.250	0.500	38	57	13
26001-6222	71	1.500	1.875	0.125	38	48	3	23547-8704	63R1	1.500	2.250	0.531	38	57	13
26001-6223	71	1.500	1.875	0.188	38	48	5	23078-7568	63F1	1.500	2.250	0.594	38	57	15
26193-6223	76	1.500	1.875	0.188	38	48	5	24801-1763	EQUAL	1.500	2.250	0.625	38	57	16
29507-6670	IG	1.500	1.875	0.625	38	48	16	24802-1763	EQUAL	1.500	2.250	0.625	38	57	16
26193-7517	76	1.500	2.000	0.250	38	51	6	24819-1763	EQUAL	1.500	2.250	0.625	38	57	16
29507-4130	IG	1.500	2.000	0.625	38	51	16	23547-6937	63R1	1.500	2.250	0.688	38	57	17
29607-4130	GD	1.500	2.000	0.625	38	51	16	23550-6937	63T2	1.500	2.250	0.688	38	57	17
24807-2578	EQUAL	1.500	2.000	0.690	38	51	18	24807-3700	EQUAL	1.500	2.250	0.690	38	57	18
29507-5952	IG	1.500	2.063	0.625	38	52	16	29502-4235	IG	1.500	2.250	0.750	38	57	19
29516-7128	IG	1.500	2.063	0.820	38	52	21	29520-4235	IG	1.500	2.250	0.750	38	57	19
24610-5997	26	1.500	2.125	0.313	38	54	8	29521-6286	IG	1.500	2.250	0.875	38	57	22
24060-1364	61	1.500	2.125	0.313	38	54	8	29502-4595	IG	1.500	2.254	0.750	38	57	19
24060-4798	61	1.500	2.125	0.375	38	54	10	24824-3545	EQUAL	1.500	2.299	0.625	38	58	16
24125-4798	61	1.500	2.125	0.375	38	54	10	24627-3391	26	1.500	2.313	0.375	38	59	10
21702-4798	62	1.500	2.125	0.375	38	54	10	24610-3391	26	1.500	2.313	0.375	38	59	10
21475-5713	63	1.500	2.125	0.437	38	54	11	24060-2410	61	1.500	2.375	0.312	38	60	8
21158-5713	63	1.500	2.125	0.437	38	54	11	24600-2450	26	1.500	2.375	0.375	38	60	10
21893-5713	63	1.500	2.125	0.437	38	54	11	21003-0646	58	1.500	2.375	0.375	38	60	10
29507-1118	IG	1.500	2.125	0.625	38	54	16	24060-0646	61	1.500	2.375	0.375	38	60	10
29607-1118	GD	1.500	2.125	0.625	38	54	16	21702-0646	62	1.500	2.375	0.375	38	60	10
24807-3410	EQUAL	1.500	2.125	0.690	38	54	18	21173-0646	63	1.500	2.375	0.375	38	60	10
29507-5373	IG	1.500	2.219	0.625	38	56	16	21290-0646	63	1.500	2.375	0.375	38	60	10
24600-9722	26	1.500	2.250	0.250	38	57	6	21159-0646	63	1.500	2.375	0.375	38	60	10
24060-9722	61	1.500	2.250	0.250	38	57	6	21391-0646	63	1.500	2.375	0.375	38	60	10
24614-1244	26	1.500	2.250	0.375	38	57	10	21158-0646	63	1.500	2.375	0.375	38	60	10
24626-0643	26	1.500	2.250	0.375	38	57	10	21372-0646	63	1.500	2.375	0.375	38	60	10
24627-0643	26	1.500	2.250	0.375	38	57	10	21893-0646	63	1.500	2.375	0.375	38	60	10
24610-0643	26	1.500	2.250	0.375	38	57	10	21695-0646	63	1.500	2.375	0.375	38	60	10
24600-0643	26	1.500	2.250	0.375	38	57	10	21527-0646	66	1.500	2.375	0.375	38	60	10
24610-1244	26	1.500	2.250	0.375	38	57	10	21528-0646	67	1.500	2.375	0.375	38	60	10
24060-0643	61	1.500	2.250	0.375	38	57	10	21823-0646	68	1.500	2.375	0.375	38	60	10
21767-0643	62	1.500	2.250	0.375	38	57	10	21158-0647	63	1.500	2.375	0.437	38	60	11
21702-0643	62	1.500	2.250	0.375	38	57	10	24062-2410	61	1.500	2.375	0.438	38	60	11
21159-0643	63	1.500	2.250	0.375	38	57	10	24622-0788	26R1	1.500	2.375	0.500	38	60	13
21475-0643	63	1.500	2.250	0.375	38	57	10	24610-0788	26	1.500	2.375	0.500	38	60	13
21158-0643	63	1.500	2.250	0.375	38	57	10	24125-0648	61	1.500	2.375	0.500	38	60	13
21163-0643	63	1.500	2.250	0.375	38	57	10	21290-0648	63	1.500	2.375	0.500	38	60	13
21173-0643	63	1.500	2.250	0.375	38	57	10	21158-0648	63	1.500	2.375	0.500	38	60	13
21893-0643	63	1.500	2.250	0.375	38	57	10	24801-0648	EQUAL	1.500	2.375	0.500	38	60	13
21795-0643	63	1.500	2.250	0.375	38	57	10	29507-1214	IG	1.500	2.375	0.625	38	60	16
21919-0643	63	1.500	2.250	0.375	38	57	10	24801-1214	EQUAL	1.500	2.375	0.625	38	60	16
21695-0643	63	1.500	2.250	0.375	38	57	10	24802-1214	EQUAL	1.500	2.375	0.625	38	60	16
21527-0643	66	1.500	2.250	0.375	38	57	10	24805-1214	EQUAL	1.500	2.375	0.625	38	60	16
21528-0643	67	1.500	2.250	0.375	38	57	10	24812-1214	EQUAL	1.500	2.375	0.625	38	60	16
21823-0643	68	1.500	2.250	0.375	38	57	10	23547-6667	63R1	1.500	2.375	0.688	38	60	17

All dimensions are in inches. Preferred sizes are indicated with **bold** type face.  
 Sizes listed are for standard nitrile elements, except Models 25 and 62 which have PTFE elements. Other material available on inquiry only.

## Oil Seals by Model Number

Product Code	Model	Inches			MM			Product Code	Model	Inches			MM		
		ID	OD	Width	ID	OD	Width			ID	OD	Width	ID	OD	Width
23548-6667	63R2	1.500	2.375	0.688	38	60	17	21158-0665	63	1.500	2.750	0.437	38	70	11
23550-6667	63T2	1.500	2.375	0.688	38	60	17	29602-5743	GD	1.500	2.750	0.700	38	70	18
29502-4810	IG	1.500	2.375	0.750	38	60	19	29502-5743	IG	1.500	2.750	0.750	38	70	19
24801-1099	EQUAL	1.500	2.378	0.500	38	60	13	21158-0667	63	1.500	2.756	0.375	38	70	10
24802-1874	EQUAL	1.500	2.410	0.625	38	61	16	21158-0668	63	1.500	2.756	0.437	38	70	11
21158-0649	63	1.500	2.437	0.375	38	62	10	24809-3020	EQUAL	1.500	2.813	0.625	38	71	16
21158-0651	63	1.500	2.437	0.500	38	62	13	29502-5578	IG	1.500	2.864	0.750	38	73	19
21158-3880	63	1.500	2.441	0.375	38	62	10	21158-5501	63	1.500	2.875	0.406	38	73	10
21500-3880	63	1.500	2.441	0.375	38	62	10	21159-3881	63	1.500	2.882	0.375	38	73	10
21695-3880	63	1.500	2.441	0.375	38	62	10	21158-3881	63	1.500	2.882	0.375	38	73	10
24802-1872	EQUAL	1.500	2.460	0.625	38	62	16	21500-3881	63	1.500	2.882	0.375	38	73	10
21158-0652	63	1.500	2.497	0.375	38	63	10	24600-0874	26	1.500	3.000	0.500	38	76	13
21158-0654	63	1.500	2.497	0.500	38	63	13	24801-3971	EQUAL	1.500	3.045	0.625	38	77	16
24802-1194	EQUAL	1.500	2.499	0.625	38	63	16	24620-4228	26R1	1.500	3.250	0.500	38	83	13
25058-0655	25	1.500	2.500	0.375	38	64	10	29507-6716	IG	1.512	2.000	0.625	38	51	16
21003-0655	58	1.500	2.500	0.375	38	64	10	21702-0670	62	1.531	2.250	0.375	39	57	10
24060-0655	61	1.500	2.500	0.375	38	64	10	21158-0670	63	1.531	2.250	0.375	39	57	10
21702-0655	62	1.500	2.500	0.375	38	64	10	21290-0673	63	1.531	2.375	0.375	39	60	10
21695-0655	63	1.500	2.500	0.375	38	64	10	21158-8076	63	1.531	2.441	0.375	39	62	10
21290-0655	63	1.500	2.500	0.375	38	64	10	21158-0679	63	1.531	2.497	0.375	39	63	10
21158-0655	63	1.500	2.500	0.375	38	64	10	21158-0682	63	1.531	2.500	0.375	39	64	10
21158-0656	63	1.500	2.500	0.437	38	64	11	24600-3993	26	1.531	2.500	0.438	39	64	11
24128-0656	61	1.500	2.500	0.438	38	64	11	21158-0685	63	1.531	2.625	0.375	39	67	10
24626-0635	26	1.500	2.500	0.500	38	64	13	21158-0693	63	1.531	2.750	0.500	39	70	13
24683-0635	26	1.500	2.500	0.500	38	64	13	24060-2574	61	1.552	2.500	0.500	39	64	13
24600-0635	26	1.500	2.500	0.500	38	64	13	24802-1779	EQUAL	1.560	2.590	0.625	40	66	16
24610-0635	26	1.500	2.500	0.500	38	64	13	29507-6782	IG	1.562	2.187	0.625	40	56	16
21702-0657	62	1.500	2.500	0.500	38	64	13	29502-4877	IG	1.562	2.441	0.750	40	62	19
23502-0657	63G1	1.500	2.500	0.500	38	64	13	29507-3029	IG	1.562	2.500	0.625	40	64	16
21159-0657	63	1.500	2.500	0.500	38	64	13	29519-3029	IG	1.562	2.500	0.625	40	64	16
21158-0657	63	1.500	2.500	0.500	38	64	13	23548-6899	63R2	1.562	2.500	0.687	40	64	17
29507-1194	IG	1.500	2.500	0.625	38	64	16	29502-5731	IG	1.562	2.598	0.750	40	66	19
29519-1194	IG	1.500	2.500	0.625	38	64	16	21695-0715	63	1.562	2.625	0.375	40	67	10
24803-1194	EQUAL	1.500	2.500	0.625	38	64	16	21527-0721	66	1.562	2.750	0.375	40	70	10
24805-1194	EQUAL	1.500	2.500	0.625	38	64	16	21158-0722	63	1.562	2.750	0.437	40	70	11
23548-6551	63R2	1.500	2.500	0.687	38	64	17	21527-6486	66	1.562	3.544	0.375	40	90	10
23627-6551	63R2	1.500	2.500	0.687	38	64	17	29502-5292	IG	1.562	3.548	0.750	40	90	19
23550-6551	63T2	1.500	2.500	0.688	38	64	17	29507-6099	IG	1.563	2.143	0.625	40	54	16
23549-6551	63TB	1.500	2.500	0.688	38	64	17	24626-0698	26	1.563	2.188	0.313	40	56	8
29602-4143	GD	1.500	2.500	0.700	38	64	18	24600-0698	26	1.563	2.189	0.313	40	56	8
29500-4143	IG	1.500	2.500	0.750	38	64	19	24600-1234	26	1.563	2.250	0.375	40	57	10
29502-4143	IG	1.500	2.500	0.750	38	64	19	21702-0700	62	1.563	2.250	0.375	40	57	10
29521-5957	IG	1.500	2.500	0.875	38	64	22	21290-0700	63	1.563	2.250	0.375	40	57	10
24802-4346	EQUAL	1.500	2.545	0.625	38	65	16	21158-0700	63	1.563	2.250	0.375	40	57	10
24802-3048	EQUAL	1.500	2.563	0.625	38	65	16	21695-0700	63	1.563	2.250	0.375	40	57	10
21158-0658	63	1.500	2.625	0.375	38	67	10	21527-0700	66	1.563	2.250	0.375	40	57	10
21158-0659	63	1.500	2.625	0.437	38	67	11	21959-0700	67	1.563	2.250	0.375	40	57	10
29519-1166	IG	1.500	2.625	0.625	38	67	16	21528-0700	67	1.563	2.250	0.375	40	57	10
24801-1166	EQUAL	1.500	2.625	0.625	38	67	16	21923-0700	67	1.563	2.250	0.375	40	57	10
24802-1166	EQUAL	1.500	2.625	0.625	38	67	16	21951-0700	67	1.563	2.250	0.375	40	57	10
24811-1166	EQUAL	1.500	2.625	0.625	38	67	16	21702-0703	62	1.563	2.375	0.375	40	60	10
23550-6448	63T2	1.500	2.625	0.687	38	67	17	21158-0703	63	1.563	2.375	0.375	40	60	10
21158-0661	63	1.500	2.686	0.375	38	68	10	21527-0703	66	1.563	2.375	0.375	40	60	10
24060-0664	61	1.500	2.750	0.375	38	70	10	21158-0704	63	1.563	2.375	0.438	40	60	11
21158-0664	63	1.500	2.750	0.375	38	70	10	21702-0705	62	1.563	2.375	0.500	40	60	13
21695-0664	63	1.500	2.750	0.375	38	70	10	23547-8104	63R1	1.563	2.375	0.688	40	60	17

All dimensions are in inches. Preferred sizes are indicated with **bold** type face.

Sizes listed are for standard nitrile elements, except Models 25 and 62 which have PTFE elements. Other material available on inquiry only.

## Oil Seals by Model Number

Product Code	Model	Inches			MM			Product Code	Model	Inches			MM		
		ID	OD	Width	ID	OD	Width			ID	OD	Width	ID	OD	Width
23548-8104	63R2	1.563	2.375	0.688	40	60	17	24629-4717	26R1	1.575	2.165	0.315	40	55	8
23627-8104	63R2	1.563	2.375	0.688	40	60	17	24064-4717	61	1.575	2.165	0.315	40	55	8
21702-0706	62	1.563	2.437	0.375	40	62	10	24060-1931	61	1.575	2.165	0.394	40	55	10
21158-0706	63	1.563	2.437	0.375	40	62	10	24056-1931	61	1.575	2.165	0.394	40	55	10
21158-0708	63	1.563	2.437	0.500	40	62	13	24626-0733	26	1.575	2.362	0.354	40	60	9
24802-3268	EQUAL	1.563	2.437	0.625	40	62	16	24600-0733	26	1.575	2.362	0.354	40	60	9
23547-7280	63R1	1.563	2.438	0.688	40	62	17	24060-1912	61	1.575	2.362	0.394	40	60	10
21158-8326	63	1.563	2.441	0.438	40	62	11	24056-1912	61	1.575	2.362	0.394	40	60	10
24060-0712	61	1.563	2.500	0.375	40	64	10	24064-1912	61	1.575	2.362	0.394	40	60	10
21702-0712	62	1.563	2.500	0.375	40	64	10	24060-7884	61	1.575	2.441	0.394	40	62	10
21158-0712	63	1.563	2.500	0.375	40	64	10	24620-0729	26R1	1.575	2.441	0.433	40	62	11
21168-0713	63	1.563	2.500	0.438	40	64	11	24602-5304	26	1.575	2.835	0.276	40	72	7
21158-0714	63	1.563	2.500	0.500	40	64	13	24626-5918	26	1.575	2.047	0.276	40	52	7
24802-3029	EQUAL	1.563	2.500	0.625	40	64	16	29507-4718	IG	1.575	2.047	0.625	40	52	16
24805-3029	EQUAL	1.563	2.500	0.625	40	64	16	24807-1359	EQUAL	1.575	2.047	0.690	40	52	18
24850-3029	EQUAL	1.563	2.500	0.625	40	64	16	29507-6148	IG	1.575	2.125	0.625	40	54	16
29502-4843	IG	1.563	2.500	0.750	40	64	19	24063-2055	61	1.575	2.165	0.315	40	55	8
29502-4470	IG	1.563	2.502	0.750	40	64	19	29507-4937	IG	1.575	2.165	0.625	40	55	16
29507-2722	IG	1.563	2.563	0.625	40	65	16	29502-5960	IG	1.575	2.165	0.750	40	55	19
29502-4274	IG	1.563	2.563	0.750	40	65	19	24060-1484	61	1.575	2.166	0.394	40	55	10
29502-4771	IG	1.563	2.623	0.750	40	67	19	24064-1931	61	1.575	2.166	0.394	40	55	10
21158-0715	63	1.563	2.625	0.375	40	67	10	24637-0735	26	1.575	2.283	0.354	40	58	9
21527-0715	66	1.563	2.625	0.375	40	67	10	29609-6972	GD	1.575	2.283	0.375	40	58	10
21159-0717	63	1.563	2.625	0.500	40	67	13	29507-5068	IG	1.575	2.283	0.625	40	58	16
21158-0717	63	1.563	2.625	0.500	40	67	13	29502-5934	IG	1.575	2.325	0.750	40	59	19
21168-0717	63	1.563	2.625	0.500	40	67	13	24063-3591	61	1.575	2.362	0.438	40	60	11
21159-0718	63	1.563	2.686	0.375	40	68	10	29602-5539	GD	1.575	2.362	0.700	40	60	18
21158-0718	63	1.563	2.686	0.375	40	68	10	29502-5539	IG	1.575	2.362	0.750	40	60	19
21430-0718	63	1.563	2.686	0.375	40	68	10	29520-5539	IG	1.575	2.362	0.750	40	60	19
29502-6155	IG	1.563	2.686	0.750	40	68	19	29524-5539	IG	1.575	2.362	0.750	40	60	19
21158-0721	63	1.563	2.750	0.375	40	70	10	24060-0132	61	1.575	2.441	0.315	40	62	8
21695-0721	63	1.563	2.750	0.375	40	70	10	24060-8610	61	1.575	2.441	0.375	40	62	10
24802-4202	EQUAL	1.563	2.750	0.625	40	70	16	21158-8610	63	1.575	2.441	0.375	40	62	10
21158-0727	63	1.563	2.783	0.375	40	71	10	21003-7884	58	1.575	2.441	0.394	40	62	10
21158-0728	63	1.563	2.783	0.438	40	71	11	21158-7884	63	1.575	2.441	0.394	40	62	10
23550-7261	63T2	1.563	2.783	0.688	40	71	17	24062-3517	61	1.575	2.441	0.438	40	62	11
21158-8078	63	1.563	2.835	0.375	40	72	10	29519-4537	IG	1.575	2.441	0.625	40	62	16
21158-3883	63	1.563	2.875	0.375	40	73	10	29607-4537	GD	1.575	2.441	0.625	40	62	16
29502-6103	IG	1.563	2.875	0.750	40	73	19	24805-4537	EQUAL	1.575	2.441	0.625	40	62	16
27223-6486	94	1.563	3.544	0.375	40	90	10	29502-4808	IG	1.575	2.441	0.750	40	62	19
29507-5482	IG	1.570	2.000	0.625	40	51	16	29609-0789	GD	1.575	2.500	0.375	40	64	10
29507-4545	IG	1.570	2.250	0.625	40	57	16	24801-3628	EQUAL	1.575	2.500	0.625	40	64	16
24802-1267	EQUAL	1.570	2.338	0.625	40	59	16	24802-3628	EQUAL	1.575	2.500	0.625	40	64	16
24805-3805	EQUAL	1.570	2.500	0.625	40	64	16	29520-6910	IG	1.575	2.500	0.750	40	64	19
29611-6853	GD	1.570	3.150	0.375	40	80	10	29619-6603	GD	1.575	2.517	0.625	40	64	16
24801-1974	EQUAL	1.570	3.188	0.625	40	81	16	29516-7184	IG	1.575	2.539	0.725	40	64	18
29507-2971	IG	1.571	2.571	0.625	40	65	16	24600-1228	26	1.575	2.559	0.276	40	65	7
24802-2971	EQUAL	1.571	2.571	0.625	40	65	16	24620-1030	26R1	1.575	2.559	0.473	40	65	12
29505-5787	IG	1.573	2.572	0.500	40	65	13	29619-6649	GD	1.575	2.559	0.625	40	65	16
29502-5051	IG	1.573	2.573	0.750	40	65	19	29602-6648	GD	1.575	2.559	0.700	40	65	18
24801-3241	EQUAL	1.573	3.250	0.625	40	83	16	29500-4895	IG	1.575	2.575	0.750	40	65	19
24600-4632	26	1.574	2.448	0.314	40	62	8	29510-4895	IG	1.575	2.575	0.750	40	65	19
24802-1803	EQUAL	1.574	2.575	0.625	40	65	16	29602-6662	GD	1.575	2.598	0.700	40	66	18
29602-6815	GD	1.574	3.142	0.700	40	80	18	29502-6662	IG	1.575	2.598	0.750	40	66	19
24802-3498	EQUAL	1.574	3.938	0.625	40	100	16	24810-4433	EQUAL	1.575	2.677	0.625	40	68	16
24600-5918	26	1.575	2.047	0.276	40	52	7	29502-6676	IG	1.575	2.835	0.750	40	72	19

All dimensions are in inches. Preferred sizes are indicated with **bold** type face. Sizes listed are for standard nitrile elements, except Models 25 and 62 which have PTFE elements. Other material available on inquiry only.

## Oil Seals by Model Number

Product Code	Model	Inches			MM			Product Code	Model	Inches			MM		
		ID	OD	Width	ID	OD	Width			ID	OD	Width	ID	OD	Width
29502-4441	IG	1.575	3.071	0.750	40	78	19	21695-0760	63	1.625	2.375	0.375	41	60	10
24801-2631	EQUAL	1.575	3.150	0.625	40	80	16	21527-0760	66	1.625	2.375	0.375	41	60	10
29519-5206	IG	1.575	3.543	0.625	40	90	16	21370-0760	66	1.625	2.375	0.375	41	60	10
24811-5206	EQUAL	1.575	3.543	0.625	40	90	16	29609-0760	GD	1.625	2.375	0.375	41	60	10
29502-1253	IG	1.575	3.543	0.740	40	90	19	29699-0016	GD	1.625	2.375	0.375	41	60	10
29602-6932	GD	1.583	2.623	0.700	40	67	18	21159-0762	63	1.625	2.375	0.500	41	60	13
21702-0730	62	1.594	2.375	0.375	40	60	10	21158-0762	63	1.625	2.375	0.500	41	60	13
21158-0730	63	1.594	2.375	0.375	40	60	10	24803-1001	EQUAL	1.625	2.375	0.500	41	60	13
21158-0739	63	1.594	2.500	0.375	40	64	10	29519-1915	IG	1.625	2.375	0.625	41	60	16
21500-0742	63	1.594	2.625	0.375	40	67	10	24801-1915	EQUAL	1.625	2.375	0.625	41	60	16
21158-0744	63	1.594	2.625	0.500	40	67	13	24802-1915	EQUAL	1.625	2.375	0.625	41	60	16
21158-0750	63	1.594	2.750	0.500	40	70	13	24802-3321	EQUAL	1.625	2.375	0.625	41	60	16
21158-0751	63	1.594	2.756	0.375	40	70	10	24803-1915	EQUAL	1.625	2.375	0.625	41	60	16
21158-0757	63	1.594	2.875	0.375	40	73	10	24805-1915	EQUAL	1.625	2.375	0.625	41	60	16
24610-5374	26	1.595	2.345	0.375	41	60	10	24807-6424	EQUAL	1.625	2.375	0.690	41	60	18
24807-3084	EQUAL	1.610	2.000	0.690	41	51	18	29502-4615	IG	1.625	2.375	0.750	41	60	19
29502-4825	IG	1.614	2.402	0.750	41	61	19	21158-0763	63	1.625	2.437	0.375	41	62	10
26001-6226	71	1.625	1.875	0.109	41	48	3	21695-0763	63	1.625	2.437	0.375	41	62	10
27023-1223	91	1.625	1.938	0.250	41	49	6	21527-0763	66	1.625	2.437	0.375	41	62	10
26001-6227	71	1.625	2.000	0.109	41	51	3	21158-0764	63	1.625	2.437	0.437	41	62	11
29607-6616	GD	1.625	2.080	0.625	41	53	16	21158-0765	63	1.625	2.437	0.500	41	62	13
26193-9971	76	1.625	2.125	0.250	41	54	6	24801-1748	EQUAL	1.625	2.437	0.500	41	62	13
24075-3018	61	1.625	2.125	0.312	41	54	8	24801-1270	EQUAL	1.625	2.437	0.625	41	62	16
29507-5360	IG	1.625	2.125	0.625	41	54	16	24600-1301	26	1.625	2.438	0.375	41	62	10
24807-4079	EQUAL	1.625	2.125	0.690	41	54	18	23078-7152	63F1	1.625	2.438	0.594	41	62	15
24807-4359	EQUAL	1.625	2.125	0.813	41	54	21	24802-1270	EQUAL	1.625	2.438	0.625	41	62	16
24060-0758	61	1.625	2.187	0.375	41	56	10	29502-4679	IG	1.625	2.438	0.750	41	62	19
24635-0758	26	1.625	2.188	0.375	41	56	10	21158-7767	63	1.625	2.441	0.375	41	62	10
24650-0758	26NS	1.625	2.188	0.375	41	56	10	21158-0766	63	1.625	2.497	0.375	41	63	10
24600-0758	26	1.625	2.188	0.375	41	56	10	21158-0767	63	1.625	2.497	0.437	41	63	11
21158-0758	63	1.625	2.188	0.375	41	56	10	21767-0769	62	1.625	2.500	0.375	41	64	10
29606-7306	GD	1.625	2.248	0.625	41	57	16	21428-0769	62	1.625	2.500	0.375	41	64	10
24626-2009	26	1.625	2.250	0.313	41	57	8	21290-0769	63	1.625	2.500	0.375	41	64	10
24060-1371	61	1.625	2.250	0.313	41	57	8	21158-0769	63	1.625	2.500	0.375	41	64	10
24067-1092	61	1.625	2.250	0.375	41	57	10	21919-0769	63	1.625	2.500	0.375	41	64	10
24060-1092	61	1.625	2.250	0.375	41	57	10	21695-0769	63	1.625	2.500	0.375	41	64	10
21290-1092	63	1.625	2.250	0.375	41	57	10	24627-0717	26	1.625	2.500	0.500	41	64	13
24063-4278	61	1.625	2.250	0.438	41	57	11	24627-0771	26	1.625	2.500	0.500	41	64	13
29507-5290	IG	1.625	2.250	0.625	41	57	16	21158-0771	63	1.625	2.500	0.500	41	64	13
29607-5290	GD	1.625	2.250	0.625	41	57	16	24801-0717	EQUAL	1.625	2.500	0.500	41	64	13
24807-2164	EQUAL	1.625	2.250	0.690	41	57	18	29519-2987	IG	1.625	2.500	0.625	41	64	16
26001-6230	71	1.625	2.375	0.250	41	60	6	24801-2987	EQUAL	1.625	2.500	0.625	41	64	16
24629-0760	26R1	1.625	2.375	0.375	41	60	10	24802-2987	EQUAL	1.625	2.500	0.625	41	64	16
24620-0760	26R1	1.625	2.375	0.375	41	60	10	24805-2987	EQUAL	1.625	2.500	0.625	41	64	16
24627-0760	26	1.625	2.375	0.375	41	60	10	23547-6860	63R1	1.625	2.500	0.688	41	64	17
24600-0760	26	1.625	2.375	0.375	41	60	10	23550-6860	63T2	1.625	2.500	0.688	41	64	17
24610-0760	26	1.625	2.375	0.375	41	60	10	29602-4327	GD	1.625	2.500	0.700	41	64	18
24060-0760	61	1.625	2.375	0.375	41	60	10	29502-4327	IG	1.625	2.500	0.750	41	64	19
21702-0760	62	1.625	2.375	0.375	41	60	10	29607-4536	GD	1.625	2.502	0.625	41	64	16
21290-0760	63	1.625	2.375	0.375	41	60	10	24805-4536	EQUAL	1.625	2.502	0.625	41	64	16
21159-0760	63	1.625	2.375	0.375	41	60	10	29502-4828	IG	1.625	2.525	0.750	41	64	19
21475-0760	63	1.625	2.375	0.375	41	60	10	21158-8615	63	1.625	2.562	0.500	41	65	13
21158-0760	63	1.625	2.375	0.375	41	60	10	21767-0772	62	1.625	2.625	0.375	41	67	10
21163-0760	63	1.625	2.375	0.375	41	60	10	21702-0772	62	1.625	2.625	0.375	41	67	10
21431-0760	63	1.625	2.375	0.375	41	60	10	21158-0772	63	1.625	2.625	0.375	41	67	10
21168-0760	63	1.625	2.375	0.375	41	60	10	21527-0772	66	1.625	2.625	0.375	41	67	10

All dimensions are in inches. Preferred sizes are indicated with **bold** type face.

Sizes listed are for standard nitrile elements, except Models 25 and 62 which have PTFE elements. Other material available on inquiry only.

## Oil Seals by Model Number

Product Code	Model	Inches			MM			Product Code	Model	Inches			MM		
		ID	OD	Width	ID	OD	Width			ID	OD	Width	ID	OD	Width
21702-0774	62	1.625	2.625	0.500	41	67	13	21158-0808	63	1.656	2.750	0.375	42	70	10
21158-0774	63	1.625	2.625	0.500	41	67	13	21158-0810	63	1.656	2.750	0.500	42	70	13
29507-1089	IG	1.625	2.625	0.625	41	67	16	21158-8083	63	1.656	2.835	0.375	42	72	10
29619-1089	GD	1.625	2.625	0.625	41	67	16	21158-0817	63	1.656	2.875	0.375	42	73	10
24802-1089	EQUAL	1.625	2.625	0.625	41	67	16	29507-7289	IG	1.675	2.360	0.625	43	60	16
23547-4766	63R1	1.625	2.625	0.688	41	67	17	29607-7289	GD	1.675	2.360	0.625	43	60	16
29602-4144	GD	1.625	2.625	0.700	41	67	18	29602-7290	GD	1.675	2.558	0.700	43	65	18
29500-4144	IG	1.625	2.625	0.750	41	67	19	29502-7290	IG	1.675	2.558	0.750	43	65	19
29502-4144	IG	1.625	2.625	0.750	41	67	19	29507-5519	IG	1.685	3.185	0.625	43	81	16
21158-0775	63	1.625	2.686	0.375	41	68	10	24614-3293	26	1.686	2.250	0.375	43	57	10
21158-0777	63	1.625	2.686	0.500	41	68	13	24060-0835	61	1.687	2.500	0.375	43	64	10
24600-1302	26	1.625	2.687	0.500	41	68	13	24600-0833	26	1.687	2.561	0.500	43	65	13
21290-0778	63	1.625	2.750	0.375	41	70	10	24612-5008	26	1.687	2.625	0.438	43	67	11
21158-0778	63	1.625	2.750	0.375	41	70	10	21428-0840	62	1.687	2.625	0.500	43	67	13
21163-0780	63	1.625	2.750	0.500	41	70	13	21919-0840	63	1.687	2.625	0.500	43	67	13
21158-0780	63	1.625	2.750	0.500	41	70	13	21158-0841	63	1.687	2.686	0.375	43	68	10
24801-0770	EQUAL	1.625	2.750	0.625	41	70	16	21919-0843	63	1.687	2.686	0.500	43	68	13
24802-0770	EQUAL	1.625	2.750	0.625	41	70	16	21158-0855	63	1.687	2.875	0.500	43	73	13
29502-6200	IG	1.625	2.750	0.750	41	70	19	24807-3495	EQUAL	1.688	2.062	0.690	43	52	18
21158-0781	63	1.625	2.756	0.375	41	70	10	26193-7527	76	1.688	2.125	0.188	43	54	5
21158-0782	63	1.625	2.756	0.437	41	70	11	24807-2522	EQUAL	1.688	2.125	0.690	43	54	18
24802-3576	EQUAL	1.625	2.800	0.625	41	71	16	29516-7129	IG	1.688	2.313	0.943	43	59	24
21158-0787	63	1.625	2.875	0.375	41	73	10	29616-7129	GD	1.688	2.313	1.173	43	59	30
21527-0787	66	1.625	2.875	0.375	41	73	10	24600-1304	26	1.688	2.375	0.375	43	60	10
21158-0788	63	1.625	2.875	0.437	41	73	11	21702-0826	62	1.688	2.375	0.375	43	60	10
24600-0876	26	1.625	2.875	0.500	41	73	13	21159-0826	63	1.688	2.375	0.375	43	60	10
21158-0789	63	1.625	2.875	0.500	41	73	13	21158-0826	63	1.688	2.375	0.375	43	60	10
21695-0789	63	1.625	2.875	0.500	41	73	13	21695-0826	63	1.688	2.375	0.375	43	60	10
23550-8266	63T2	1.625	2.875	0.688	41	73	17	21158-0828	63	1.688	2.375	0.500	43	60	13
29500-6013	IG	1.625	2.875	0.750	41	73	19	23547-7569	63R1	1.688	2.375	0.688	43	60	17
29620-6856	GD	1.625	3.000	0.700	41	76	18	23550-7569	63T2	1.688	2.375	0.688	43	60	17
29502-6410	IG	1.625	3.500	0.750	41	89	19	24807-3159	EQUAL	1.688	2.375	0.690	43	60	18
27223-7636	94	1.625	3.750	0.750	41	95	19	24610-4421	26	1.688	2.437	0.313	43	62	8
29507-6059	IG	1.650	2.350	0.625	42	60	16	24060-0829	61	1.688	2.437	0.375	43	62	10
24600-1096	26	1.653	2.441	0.315	42	62	8	21767-0829	62	1.688	2.437	0.375	43	62	10
24060-1793	61	1.653	2.441	0.394	42	62	10	21702-0829	62	1.688	2.437	0.375	43	62	10
24125-3004	61	1.654	2.362	0.394	42	60	10	21158-0829	63	1.688	2.437	0.375	43	62	10
24060-3004	61	1.654	2.362	0.394	42	60	10	21158-0830	63	1.688	2.437	0.437	43	62	11
24128-1793	61	1.654	2.441	0.394	42	62	10	25009-0829	23	1.688	2.438	0.375	43	62	10
24125-1793	61	1.654	2.441	0.394	42	62	10	23078-9234	63F1	1.688	2.438	0.625	43	62	16
29516-7208	IG	1.654	2.146	0.725	42	55	18	29502-6063	IG	1.688	2.438	0.750	43	62	19
24600-0791	26	1.654	2.165	0.394	42	55	10	21158-0832	63	1.688	2.497	0.375	43	63	10
29507-4938	IG	1.654	2.165	0.625	42	55	16	24600-0835	26	1.688	2.500	0.375	43	64	10
23502-2165	63G1	1.654	2.441	0.598	42	62	15	21702-0835	62	1.688	2.500	0.375	43	64	10
24801-2918	EQUAL	1.654	2.441	0.625	42	62	16	21158-0835	63	1.688	2.500	0.375	43	64	10
29502-5540	IG	1.654	2.441	0.750	42	62	19	21168-0835	63	1.688	2.500	0.375	43	64	10
24801-2611	EQUAL	1.654	2.559	0.625	42	65	16	21695-0835	63	1.688	2.500	0.375	43	64	10
24801-2127	EQUAL	1.654	2.598	0.625	42	66	16	21158-0836	63	1.688	2.500	0.437	43	64	11
29502-4439	IG	1.654	2.625	0.750	42	67	19	24062-0837	61	1.688	2.500	0.500	43	64	13
29502-6304	IG	1.654	2.835	0.750	42	72	19	21158-0837	63	1.688	2.500	0.500	43	64	13
24802-5448	EQUAL	1.654	4.193	0.625	42	107	16	24801-0790	EQUAL	1.688	2.500	0.500	43	64	13
21290-8082	63	1.656	2.441	0.375	42	62	10	23078-7254	63F1	1.688	2.500	0.594	43	64	15
21158-0799	63	1.656	2.500	0.375	42	64	10	24650-0834	26NS	1.688	2.502	0.375	43	64	10
21158-0804	63	1.656	2.625	0.500	42	67	13	24626-0834	26	1.688	2.502	0.375	43	64	10
21158-0805	63	1.656	2.686	0.375	42	68	10	24600-0834	26	1.688	2.502	0.375	43	64	10
21158-0807	63	1.656	2.686	0.500	42	68	13	29507-5408	IG	1.688	2.506	0.625	43	64	16

All dimensions are in inches. Preferred sizes are indicated with **bold** type face.  
 Sizes listed are for standard nitrile elements, except Models 25 and 62 which have PTFE elements. Other material available on inquiry only.

## Oil Seals by Model Number

Product Code	Model	Inches			MM			Product Code	Model	Inches			MM		
		ID	OD	Width	ID	OD	Width			ID	OD	Width	ID	OD	Width
24602-2658	26	1.688	2.563	0.313	43	65	8	21158-0886	63	1.719	2.875	0.375	44	73	10
21158-0838	63	1.688	2.625	0.375	43	67	10	21158-0887	63	1.719	2.875	0.437	44	73	11
21527-0838	66	1.688	2.625	0.375	43	67	10	21158-0892	63	1.719	3.000	0.375	44	76	10
24600-0840	26	1.688	2.625	0.500	43	67	13	24807-3784	EQUAL	1.720	2.250	0.690	44	57	18
21158-0840	63	1.688	2.625	0.500	43	67	13	24802-5494	EQUAL	1.725	2.625	0.625	44	67	16
23550-6934	63T2	1.688	2.625	0.688	43	67	17	29507-5225	IG	1.726	2.250	0.625	44	57	16
29500-5415	IG	1.688	2.625	0.750	43	67	19	29507-4864	IG	1.732	2.250	0.625	44	57	16
29502-5415	IG	1.688	2.625	0.750	43	67	19	29502-6070	IG	1.732	2.756	0.750	44	70	19
21702-0843	62	1.688	2.686	0.500	43	68	13	29507-5201	IG	1.745	2.745	0.625	44	70	16
21158-0843	63	1.688	2.686	0.500	43	68	13	29502-6521	IG	1.748	2.866	0.750	44	73	19
21168-0843	63	1.688	2.686	0.500	43	68	13	26001-6240	71	1.750	2.000	0.109	44	51	3
21467-0843	66	1.688	2.686	0.500	43	68	13	26001-6241	71	1.750	2.125	0.125	44	54	3
23548-6753	63R2	1.688	2.686	0.688	43	68	17	26001-6242	71	1.750	2.125	0.188	44	54	5
23550-6753	63T2	1.688	2.686	0.688	43	68	17	26001-6242	76	1.750	2.125	0.188	44	54	5
24610-0638	26	1.688	2.688	0.500	43	68	13	26001-7080	71	1.750	2.250	0.250	44	57	6
24801-2723	EQUAL	1.688	2.688	0.625	43	68	16	26193-9675	76	1.750	2.250	0.313	44	57	8
29602-4275	GD	1.688	2.688	0.700	43	68	18	29507-4586	IG	1.750	2.250	0.625	44	57	16
29502-4275	IG	1.688	2.688	0.750	43	68	19	24807-3952	EQUAL	1.750	2.250	0.690	44	57	18
21290-0844	63	1.688	2.750	0.375	43	70	10	29507-5319	IG	1.750	2.312	0.625	44	59	16
21158-0844	63	1.688	2.750	0.375	43	70	10	29507-6806	IG	1.750	2.335	0.625	44	59	16
21695-0844	63	1.688	2.750	0.375	43	70	10	26001-7081	71	1.750	2.375	0.250	44	60	6
24600-1305	26	1.688	2.750	0.438	43	70	11	24125-9822	61	1.750	2.375	0.312	44	60	8
21158-0846	63	1.688	2.750	0.500	43	70	13	24602-5156	26	1.750	2.375	0.313	44	60	8
24801-1341	EQUAL	1.688	2.750	0.625	43	70	16	21767-9822	62	1.750	2.375	0.313	44	60	8
24802-1341	EQUAL	1.688	2.750	0.625	43	70	16	21290-9822	63	1.750	2.375	0.313	44	60	8
23548-6554	63R2	1.688	2.750	0.688	43	70	17	21158-9822	63	1.750	2.375	0.313	44	60	8
23550-6554	63T2	1.688	2.750	0.688	43	70	17	25058-0813	25	1.750	2.375	0.375	44	60	10
21158-0848	63	1.688	2.756	0.437	43	70	11	24067-0813	61	1.750	2.375	0.375	44	60	10
21158-0849	63	1.688	2.756	0.500	43	70	13	24060-0813	61	1.750	2.375	0.375	44	60	10
21158-7126	63	1.688	2.835	0.375	43	72	10	21290-0813	63	1.750	2.375	0.375	44	60	10
24060-0853	61	1.688	2.875	0.375	43	73	10	24063-3153	61	1.750	2.375	0.437	44	60	11
21290-0853	63	1.688	2.875	0.375	43	73	10	24062-1377	61	1.750	2.375	0.500	44	60	13
21158-0853	63	1.688	2.875	0.375	43	73	10	29507-4183	IG	1.750	2.375	0.625	44	60	16
21158-0859	63	1.688	3.000	0.375	43	76	10	29607-4183	GD	1.750	2.375	0.625	44	60	16
21431-0859	63	1.688	3.000	0.375	43	76	10	24807-2200	EQUAL	1.750	2.375	0.690	44	60	18
24803-3011	EQUAL	1.688	3.313	0.625	43	84	16	24600-0898	26	1.750	2.437	0.375	44	62	10
29502-5692	IG	1.688	3.437	0.750	43	87	19	24060-0898	61	1.750	2.437	0.375	44	62	10
24809-3151	EQUAL	1.690	2.813	0.625	43	71	16	21702-0898	62	1.750	2.437	0.375	44	62	10
29502-6894	IG	1.693	2.443	0.750	43	62	19	21475-0898	63	1.750	2.437	0.375	44	62	10
29602-6776	GD	1.693	2.480	0.700	43	63	18	21158-0898	63	1.750	2.437	0.375	44	62	10
24060-2532	61	1.693	2.756	0.315	43	70	8	21755-0898	63	1.750	2.437	0.375	44	62	10
24063-3274	61	1.710	2.375	0.438	43	60	11	21527-0898	66	1.750	2.437	0.375	44	62	10
29521-6087	IG	1.710	3.000	0.875	43	76	22	21528-0898	67	1.750	2.437	0.375	44	62	10
29507-5737	IG	1.716	2.219	0.625	44	56	16	21823-0898	68	1.750	2.437	0.375	44	62	10
21158-0862	63	1.719	2.437	0.375	44	62	10	21158-0899	63	1.750	2.437	0.438	44	62	11
21158-0868	63	1.719	2.500	0.375	44	64	10	29507-5401	IG	1.750	2.437	0.625	44	62	16
21158-8484	63	1.719	2.561	0.500	44	65	13	29606-5401	GD	1.750	2.437	0.625	44	62	16
21158-0871	63	1.719	2.625	0.375	44	67	10	29607-5401	GD	1.750	2.437	0.625	44	62	16
24801-3071	EQUAL	1.719	2.625	0.625	44	67	16	23548-4671	63R2	1.750	2.437	0.688	44	62	17
23548-8646	63R2	1.719	2.625	0.687	44	67	17	23627-4671	63R2	1.750	2.437	0.688	44	62	17
21702-0874	62	1.719	2.686	0.375	44	68	10	23550-4671	63T2	1.750	2.437	0.688	44	62	17
21158-0874	63	1.719	2.686	0.375	44	68	10	24807-1780	EQUAL	1.750	2.437	0.690	44	62	18
21158-0877	63	1.719	2.750	0.375	44	70	10	24060-1386	61	1.750	2.438	0.312	44	62	8
21158-0883	63	1.719	2.783	0.375	44	71	10	21290-0898	63	1.750	2.438	0.375	44	62	10
21158-0885	63	1.719	2.783	0.500	44	71	13	21702-9620	62	1.750	2.441	0.375	44	62	10
21158-5963	63	1.719	2.835	0.375	44	72	10	21158-9620	63	1.750	2.441	0.375	44	62	10

All dimensions are in inches. Preferred sizes are indicated with **bold** type face.

Sizes listed are for standard nitrile elements, except Models 25 and 62 which have PTFE elements. Other material available on inquiry only.

## Oil Seals by Model Number

Product Code	Model	Inches			MM			Product Code	Model	Inches			MM		
		ID	OD	Width	ID	OD	Width			ID	OD	Width	ID	OD	Width
21702-0901	62	1.750	2.497	0.375	44	63	10	24802-1062	EQUAL	1.750	2.625	0.625	44	67	16
21158-0901	63	1.750	2.497	0.375	44	63	10	24819-1062	EQUAL	1.750	2.625	0.625	44	67	16
24627-2967	26	1.750	2.500	0.313	44	64	8	23548-7228	63R2	1.750	2.625	0.687	44	67	17
24610-2967	26	1.750	2.500	0.313	44	64	8	23627-7228	63R2	1.750	2.625	0.688	44	67	17
25009-0904	23	1.750	2.500	0.375	44	64	10	24807-3739	EQUAL	1.750	2.625	0.690	44	67	18
25003-0904	23	1.750	2.500	0.375	44	64	10	29602-4323	GD	1.750	2.625	0.700	44	67	18
24626-0904	26	1.750	2.500	0.375	44	64	10	29502-4323	IG	1.750	2.625	0.750	44	67	19
24627-0904	26	1.750	2.500	0.375	44	64	10	29520-4323	IG	1.750	2.625	0.750	44	67	19
24600-0904	26	1.750	2.500	0.375	44	64	10	25003-8721	23	1.750	2.656	0.625	44	67	16
24683-0904	26	1.750	2.500	0.375	44	64	10	24627-6237	26	1.750	2.686	0.313	44	68	8
24610-0904	26	1.750	2.500	0.375	44	64	10	24610-6237	26	1.750	2.686	0.313	44	68	8
24612-0904	26	1.750	2.500	0.375	44	64	10	21290-0910	63	1.750	2.686	0.375	44	68	10
24060-0904	61	1.750	2.500	0.375	44	64	10	21158-0910	63	1.750	2.686	0.375	44	68	10
21702-0904	62	1.750	2.500	0.375	44	64	10	21158-0911	63	1.750	2.686	0.437	44	68	11
21290-0904	63	1.750	2.500	0.375	44	64	10	21158-0912	63	1.750	2.686	0.500	44	68	13
21159-0904	63	1.750	2.500	0.375	44	64	10	29609-7299	GD	1.750	2.693	0.375	44	68	10
21475-0904	63	1.750	2.500	0.375	44	64	10	29602-7297	GD	1.750	2.693	0.700	44	68	18
21158-0904	63	1.750	2.500	0.375	44	64	10	29502-5471	IG	1.750	2.700	0.750	44	69	19
21695-0904	63	1.750	2.500	0.375	44	64	10	24060-3583	61	1.750	2.716	0.313	44	69	8
21527-0904	66	1.750	2.500	0.375	44	64	10	24802-3257	EQUAL	1.750	2.716	0.625	44	69	16
21959-0904	67	1.750	2.500	0.375	44	64	10	21158-7459	63	1.750	2.719	0.359	44	69	9
21528-0904	67	1.750	2.500	0.375	44	64	10	24620-0896	26R1	1.750	2.750	0.313	44	70	8
24062-0905	61	1.750	2.500	0.437	44	64	11	24600-1767	26	1.750	2.750	0.375	44	70	10
21158-0905	63	1.750	2.500	0.437	44	64	11	24610-1767	26	1.750	2.750	0.375	44	70	10
21158-0906	63	1.750	2.500	0.500	44	64	13	24060-0913	61	1.750	2.750	0.375	44	70	10
21163-0906	63	1.750	2.500	0.500	44	64	13	21702-0913	62	1.750	2.750	0.375	44	70	10
29505-0707	IG	1.750	2.500	0.500	44	64	13	21158-0913	63	1.750	2.750	0.375	44	70	10
29507-1026	IG	1.750	2.500	0.625	44	64	16	21527-0913	66	1.750	2.750	0.375	44	70	10
29607-1026	GD	1.750	2.500	0.625	44	64	16	21823-0913	68	1.750	2.750	0.375	44	70	10
24801-1026	EQUAL	1.750	2.500	0.625	44	64	16	29699-0008	GD	1.750	2.750	0.375	44	70	10
24802-1026	EQUAL	1.750	2.500	0.625	44	64	16	21158-0914	63	1.750	2.750	0.437	44	70	11
24803-1026	EQUAL	1.750	2.500	0.625	44	64	16	24626-0639	26	1.750	2.750	0.500	44	70	13
24805-1026	EQUAL	1.750	2.500	0.625	44	64	16	24600-0639	26	1.750	2.750	0.500	44	70	13
24824-1026	EQUAL	1.750	2.500	0.625	44	64	16	24610-0639	26	1.750	2.750	0.500	44	70	13
24825-1026	EQUAL	1.750	2.500	0.625	44	64	16	21702-0915	62	1.750	2.750	0.500	44	70	13
23550-4672	63T2	1.750	2.500	0.688	44	64	17	23501-0915	63G1	1.750	2.750	0.500	44	70	13
24807-2693	EQUAL	1.750	2.500	0.690	44	64	18	21158-0915	63	1.750	2.750	0.500	44	70	13
29602-4319	GD	1.750	2.500	0.700	44	64	18	21168-0915	63	1.750	2.750	0.500	44	70	13
29500-4319	IG	1.750	2.500	0.750	44	64	19	21695-0915	63	1.750	2.750	0.500	44	70	13
29502-4319	IG	1.750	2.500	0.750	44	64	19	24801-0639	EQUAL	1.750	2.750	0.500	44	70	13
24610-3563	26	1.750	2.563	0.375	44	65	10	29507-1744	IG	1.750	2.750	0.625	44	70	16
24809-5616	EQUAL	1.750	2.620	0.625	44	67	16	29607-1744	GD	1.750	2.750	0.625	44	70	16
27223-3264	94	1.750	2.623	0.438	44	67	11	29619-7390	GD	1.750	2.750	0.625	44	70	16
24600-2456	26	1.750	2.625	0.312	44	67	8	24801-1744	EQUAL	1.750	2.750	0.625	44	70	16
24627-3254	26	1.750	2.625	0.375	44	67	10	24802-1744	EQUAL	1.750	2.750	0.625	44	70	16
24060-0907	61	1.750	2.625	0.375	44	67	10	24803-1744	EQUAL	1.750	2.750	0.625	44	70	16
21290-0907	63	1.750	2.625	0.375	44	67	10	24805-1744	EQUAL	1.750	2.750	0.625	44	70	16
21158-0907	63	1.750	2.625	0.375	44	67	10	24819-1744	EQUAL	1.750	2.750	0.625	44	70	16
21695-0907	63	1.750	2.625	0.375	44	67	10	23547-6832	63R1	1.750	2.750	0.688	44	70	17
21158-0908	63	1.750	2.625	0.437	44	67	11	23548-6832	63R2	1.750	2.750	0.688	44	70	17
24620-0909	26R1	1.750	2.625	0.500	44	67	13	29602-4145	GD	1.750	2.750	0.700	44	70	18
21158-0909	63	1.750	2.625	0.500	44	67	13	29500-4145	IG	1.750	2.750	0.750	44	70	19
24801-0909	EQUAL	1.750	2.625	0.500	44	67	13	29502-4145	IG	1.750	2.750	0.750	44	70	19
23078-6028	63F1	1.750	2.625	0.594	44	67	15	29520-4145	IG	1.750	2.750	0.750	44	70	19
29507-1062	IG	1.750	2.625	0.625	44	67	16	21158-0916	63	1.750	2.756	0.375	44	70	10
24801-1062	EQUAL	1.750	2.625	0.625	44	67	16	21158-0918	63	1.750	2.756	0.500	44	70	13

All dimensions are in inches. Preferred sizes are indicated with **bold** type face.  
 Sizes listed are for standard nitrile elements, except Models 25 and 62 which have PTFE elements. Other material available on inquiry only.

## Oil Seals by Model Number

Product Code	Model	Inches			MM			Product Code	Model	Inches			MM		
		ID	OD	Width	ID	OD	Width			ID	OD	Width	ID	OD	Width
24816-4446	EQUAL	1.750	2.776	0.750	44	71	19	29602-4348	GD	1.750	3.937	0.700	44	100	18
21158-0919	63	1.750	2.783	0.375	44	71	10	29502-4348	IG	1.750	3.938	0.750	44	100	19
21158-0921	63	1.750	2.783	0.500	44	71	13	29503-4348	IG	1.750	3.938	0.750	44	100	19
21158-6725	63	1.750	2.835	0.375	44	72	10	29501-4412	IG	1.750	4.725	0.750	44	120	19
29502-6081	IG	1.750	2.850	0.750	44	72	19	29502-4412	IG	1.750	4.725	0.750	44	120	19
24610-2459	26	1.750	2.875	0.375	44	73	10	29519-1026	IG	1.750		0.625	44	0	16
21290-0922	63	1.750	2.875	0.375	44	73	10	29505-5788	IG	1.754	2.754	0.500	45	70	13
21158-0922	63	1.750	2.875	0.375	44	73	10	29507-5217	IG	1.754	2.754	0.625	45	70	16
21527-0922	66	1.750	2.875	0.375	44	73	10	29502-5167	IG	1.754	2.754	0.750	45	70	19
21158-0923	63	1.750	2.875	0.437	44	73	11	29502-4546	IG	1.755	3.358	0.750	45	85	19
24060-0924	61	1.750	2.875	0.500	44	73	13	29502-4692	IG	1.760	2.875	0.750	45	73	19
23501-0924	63G1	1.750	2.875	0.500	44	73	13	29502-6250	IG	1.763	2.960	0.750	45	75	19
21158-0924	63	1.750	2.875	0.500	44	73	13	29602-5523	GD	1.764	2.764	0.700	45	70	18
24801-0879	EQUAL	1.750	2.875	0.500	44	73	13	29520-4046	IG	1.765	2.750	0.750	45	70	19
29507-0998	IG	1.750	2.875	0.625	44	73	16	29507-5138	IG	1.766	2.323	0.625	45	59	16
29519-0998	IG	1.750	2.875	0.625	44	73	16	21158-9223	63	1.766	2.559	0.375	45	65	10
29612-0998	GD	1.750	2.875	0.625	44	73	16	24802-2292	EQUAL	1.766	2.750	0.625	45	70	16
24801-0998	EQUAL	1.750	2.875	0.625	44	73	16	29602-4350	GD	1.766	2.750	0.700	45	70	18
24802-0998	EQUAL	1.750	2.875	0.625	44	73	16	29502-4350	IG	1.766	2.750	0.750	45	70	19
24806-0998	EQUAL	1.750	2.875	0.625	44	73	16	27223-8004	94	1.766	2.953	0.313	45	75	8
24819-0998	EQUAL	1.750	2.875	0.625	44	73	16	24806-2023	EQUAL	1.767	2.800	0.625	45	71	16
24822-0998	EQUAL	1.750	2.875	0.625	44	73	16	29507-5738	IG	1.768	2.193	0.625	45	56	16
29602-4107	GD	1.750	2.875	0.700	44	73	18	24060-3019	61	1.770	2.627	0.312	45	67	8
29500-4107	IG	1.750	2.875	0.750	44	73	19	29500-4656	IG	1.770	2.875	0.750	45	73	19
29502-4107	IG	1.750	2.875	0.750	44	73	19	24801-1784	EQUAL	1.771	2.521	0.500	45	64	13
29503-4107	IG	1.750	2.875	0.750	44	73	19	29507-4613	IG	1.771	2.559	0.625	45	65	16
29520-4107	IG	1.750	2.875	0.750	44	73	19	24842-4613	EQUAL	1.771	2.559	0.625	45	65	16
21158-0927	63	1.750	2.997	0.500	44	76	13	24600-4633	26	1.771	2.568	0.398	45	65	10
24060-0928	61	1.750	3.000	0.375	44	76	10	29519-1655	IG	1.771	2.750	0.625	45	70	16
21702-0928	62	1.750	3.000	0.375	44	76	10	24802-1804	EQUAL	1.771	2.996	0.625	45	76	16
21158-0928	63	1.750	3.000	0.375	44	76	10	29502-4678	IG	1.771	3.937	0.750	45	100	19
21528-0928	67	1.750	3.000	0.375	44	76	10	29500-4678	IG	1.771	3.938	0.750	45	100	19
21158-0930	63	1.750	3.000	0.500	44	76	13	24620-0935	26R1	1.772	2.441	0.315	45	62	8
24801-0720	EQUAL	1.750	3.000	0.500	44	76	13	24600-1097	26	1.772	2.441	0.394	45	62	10
23078-7555	63F1	1.750	3.000	0.594	44	76	15	24610-4044	26	1.772	2.559	0.394	45	65	10
23548-6522	63R2	1.750	3.000	0.687	44	76	17	24060-9223	61	1.772	2.559	0.394	45	65	10
23550-6522	63T2	1.750	3.000	0.687	44	76	17	29507-4554	IG	1.772	2.165	0.625	45	55	16
23547-6522	63R1	1.750	3.000	0.688	44	76	17	29507-6628	IG	1.772	2.324	0.625	45	59	16
21158-0931	63	1.750	3.062	0.375	44	78	10	29507-4939	IG	1.772	2.362	0.625	45	60	16
21527-0931	66	1.750	3.062	0.375	44	78	10	29607-4939	GD	1.772	2.362	0.625	45	60	16
21158-6724	63	1.750	3.125	0.375	44	79	10	24807-3149	EQUAL	1.772	2.362	0.690	45	60	18
21527-6724	66	1.750	3.125	0.375	44	79	10	24823-4939	EQUAL	1.772	2.362	0.690	45	60	18
24802-3975	EQUAL	1.750	3.125	0.625	44	79	16	24060-1796	61	1.772	2.363	0.315	45	60	8
21158-8085	63	1.750	3.150	0.375	44	80	10	24610-1097	26	1.772	2.441	0.394	45	62	10
25010-3885	23	1.750	3.189	0.500	44	81	13	21003-1797	58	1.772	2.441	0.394	45	62	10
25003-3885	23	1.750	3.189	0.500	44	81	13	24060-1797	61	1.772	2.441	0.394	45	62	10
25004-3885	23	1.750	3.189	0.500	44	81	13	24062-4354	61	1.772	2.441	0.438	45	62	11
25166-3885	23	1.750	3.189	0.500	44	81	13	29507-4940	IG	1.772	2.441	0.625	45	62	16
21290-3885	63	1.750	3.189	0.500	44	81	13	29607-4940	GD	1.772	2.441	0.625	45	62	16
21158-3885	63	1.750	3.189	0.500	44	81	13	24807-1923	EQUAL	1.772	2.441	0.690	45	62	18
24831-5616	EQUAL	1.750	3.250	0.550	44	83	14	29507-6359	IG	1.772	2.449	0.625	45	62	16
21527-4899	66	1.750	3.543	0.437	44	90	11	29519-6829	IG	1.772	2.522	0.625	45	64	16
29501-4411	IG	1.750	3.543	0.750	44	90	19	29516-7234	IG	1.772	2.539	0.725	45	64	18
29502-6073	IG	1.750	3.563	0.750	44	91	19	24816-7063	EQUAL	1.772	2.539	0.748	45	64	19
21527-8456	66	1.750	3.625	0.437	44	92	11	24064-1799	61	1.772	2.559	0.315	45	65	8
29502-5977	IG	1.750	3.924	0.750	44	100	19	24626-4044	26	1.772	2.559	0.394	45	65	10

All dimensions are in inches. Preferred sizes are indicated with **bold** type face.

Sizes listed are for standard nitrile elements, except Models 25 and 62 which have PTFE elements. Other material available on inquiry only.



## Oil Seals by Model Number

Product Code	Model	Inches			MM			Product Code	Model	Inches			MM		
		ID	OD	Width	ID	OD	Width			ID	OD	Width	ID	OD	Width
24600-4044	26	1.772	2.559	0.394	45	65	10	29519-6198	IG	1.781	3.938	0.625	45	100	16
24062-9223	61	1.772	2.559	0.394	45	65	10	29500-5328	IG	1.810	2.875	0.750	46	73	19
29502-5541	IG	1.772	2.559	0.750	45	65	19	24637-0968	26	1.811	2.520	0.354	46	64	9
29511-5541	IG	1.772	2.559	0.750	45	65	19	21158-0987	63	1.811	2.756	0.512	46	70	13
29520-5541	IG	1.772	2.559	0.750	45	65	19	29502-6069	IG	1.811	2.835	0.750	46	72	19
24626-1579	26	1.772	2.622	0.500	45	67	13	24128-3021	61	1.811	2.835	0.394	46	72	10
24600-1579	26	1.772	2.622	0.500	45	67	13	24600-0976	26	1.812	2.625	0.375	46	67	10
29502-5135	IG	1.772	2.622	0.750	45	67	19	21158-8088	63	1.812	2.835	0.375	46	72	10
24852-4475	EQUAL	1.772	2.625	0.690	45	67	18	29502-4560	IG	1.812	2.875	0.750	46	73	19
24801-1374	EQUAL	1.772	2.638	0.500	45	67	13	29507-4414	IG	1.813	2.313	0.625	46	59	16
24806-4527	EQUAL	1.772	2.648	0.625	45	67	16	26001-7083	71	1.813	2.375	0.188	46	60	5
29519-6398	IG	1.772	2.677	0.625	45	68	16	21158-0970	63	1.813	2.497	0.375	46	63	10
24062-3211	61	1.772	2.750	0.438	45	70	11	21158-0972	63	1.813	2.497	0.500	46	63	13
29502-5594	IG	1.772	2.750	0.750	45	70	19	24600-0973	26	1.813	2.500	0.375	46	64	10
29609-7522	GD	1.772	2.756	0.375	45	70	10	21158-0973	63	1.813	2.500	0.375	46	64	10
29502-4490	IG	1.772	2.756	0.750	45	70	19	21158-0975	63	1.813	2.500	0.500	46	64	13
29516-7159	IG	1.772	2.776	0.767	45	71	19	21158-0976	63	1.813	2.625	0.375	46	67	10
29502-6339	IG	1.772	2.795	0.750	45	71	19	21158-0979	63	1.813	2.686	0.375	46	68	10
29502-5930	IG	1.772	2.835	0.750	45	72	19	21158-0982	63	1.813	2.750	0.375	46	70	10
29502-4581	IG	1.772	2.953	0.750	45	75	19	21695-0982	63	1.813	2.750	0.375	46	70	10
29502-5766	IG	1.772	3.021	0.750	45	77	19	21158-0984	63	1.813	2.750	0.500	46	70	13
29524-5766	IG	1.772	3.021	0.750	45	77	19	21163-0984	63	1.813	2.750	0.500	46	70	13
29516-7130	IG	1.772	3.228	0.710	45	82	18	29507-5308	IG	1.813	2.750	0.625	46	70	16
29502-6486	IG	1.772	3.327	0.750	45	85	19	21158-9633	63	1.813	2.758	0.500	46	70	13
29519-5656	IG	1.772	3.346	0.394	45	85	10	29502-4276	IG	1.813	2.813	0.750	46	71	19
29519-6907	IG	1.772	3.346	0.625	45	85	16	21158-0991	63	1.813	2.875	0.375	46	73	10
29502-5819	IG	1.772	3.346	0.750	45	85	19	29519-6005	IG	1.813	2.875	0.625	46	73	16
29518-6789	IG	1.772	3.346	0.875	45	85	22	24802-6005	EQUAL	1.813	2.875	0.625	46	73	16
29502-5807	IG	1.772	3.543	0.750	45	90	19	29500-4560	IG	1.813	2.875	0.750	46	73	19
29502-6176	IG	1.772	3.887	0.750	45	99	19	21290-0997	63	1.813	3.000	0.375	46	76	10
24060-3449	61	1.772	4.000	0.394	45	102	10	21158-0997	63	1.813	3.000	0.375	46	76	10
29507-5291	IG	1.773	2.500	0.625	45	64	16	21158-1003	63	1.813	3.125	0.375	46	79	10
21158-8405	63	1.781	2.438	0.375	45	62	10	21163-1003	63	1.813	3.125	0.375	46	79	10
21159-7761	63	1.781	2.441	0.375	45	62	10	21158-1005	63	1.813	3.125	0.500	46	79	13
21158-7761	63	1.781	2.441	0.375	45	62	10	21695-1003	63	1.813	3.125	0.875	46	79	22
21158-0934	63	1.781	2.497	0.375	45	63	10	24801-3143	EQUAL	1.838	2.750	0.625	47	70	16
21158-0937	63	1.781	2.500	0.375	45	64	10	21158-3887	63	1.844	2.500	0.375	47	64	10
21168-0937	63	1.781	2.500	0.375	45	64	10	21159-1006	63	1.844	2.625	0.375	47	67	10
21695-0937	63	1.781	2.500	0.375	45	64	10	21163-1006	63	1.844	2.625	0.375	47	67	10
29507-6827	IG	1.781	2.500	0.625	45	64	16	21158-1006	63	1.844	2.625	0.375	47	67	10
24807-1903	EQUAL	1.781	2.500	0.690	45	64	18	21158-1012	63	1.844	2.750	0.375	47	70	10
21158-0940	63	1.781	2.625	0.375	45	67	10	21695-1012	63	1.844	2.750	0.375	47	70	10
21431-0940	63	1.781	2.625	0.375	45	67	10	21158-1023	63	1.844	2.875	0.500	47	73	13
27223-0940	94	1.781	2.625	0.375	45	67	10	21158-8091	63	1.844	3.150	0.375	47	80	10
21158-0945	63	1.781	2.686	0.500	45	68	13	29520-6169	IG	1.850	2.835	0.750	47	72	19
21158-0946	63	1.781	2.750	0.375	45	70	10	24802-1398	EQUAL	1.873	2.813	0.625	48	71	16
21158-0951	63	1.781	2.756	0.500	45	70	13	29507-5747	IG	1.875	2.250	0.625	48	57	16
21158-8086	63	1.781	2.835	0.375	45	72	10	26001-7084	71	1.875	2.375	0.250	48	60	6
21158-0955	63	1.781	2.875	0.375	45	73	10	24807-3912	EQUAL	1.875	2.375	0.690	48	60	18
21158-0967	63	1.781	3.125	0.375	45	79	10	21332-2053	143	1.875	2.475	0.510	48	63	13
21158-0969	63	1.781	3.125	0.500	45	79	13	24060-1412	61	1.875	2.500	0.312	48	64	8
21168-0969	63	1.781	3.125	0.500	45	79	13	24060-1418	61	1.875	2.500	0.375	48	64	10
24802-1898	EQUAL	1.781	3.125	0.625	45	79	16	24062-1419	61	1.875	2.500	0.500	48	64	13
29505-6715	IG	1.781	3.543	0.500	45	90	13	24060-1419	61	1.875	2.500	0.500	48	64	13
29502-6102	IG	1.781	3.546	0.750	45	90	19	29507-5824	IG	1.875	2.500	0.625	48	64	16
27223-4598	94	1.781	3.938	0.375	45	100	10	24807-3565	EQUAL	1.875	2.500	0.690	48	64	18

All dimensions are in inches. Preferred sizes are indicated with **bold** type face. Sizes listed are for standard nitrile elements, except Models 25 and 62 which have PTFE elements. Other material available on inquiry only.

## Oil Seals by Model Number

Product Code	Model	Inches			MM			Product Code	Model	Inches			MM		
		ID	OD	Width	ID	OD	Width			ID	OD	Width	ID	OD	Width
24807-3319	EQUAL	1.875	2.563	0.690	48	65	18	21528-1048	67	1.875	2.750	0.375	48	70	10
29507-6296	IG	1.875	2.575	0.625	48	65	16	29609-3977	GD	1.875	2.750	0.375	48	70	10
24600-5844	26	1.875	2.623	0.313	48	67	8	24626-1039	26	1.875	2.750	0.500	48	70	13
24620-5844	26R1	1.875	2.625	0.313	48	67	8	24600-1039	26	1.875	2.750	0.500	48	70	13
25003-1042	23	1.875	2.625	0.375	48	67	10	21158-1050	63	1.875	2.750	0.500	48	70	13
24627-1042	26	1.875	2.625	0.375	48	67	10	29507-1075	IG	1.875	2.750	0.625	48	70	16
24610-1042	26	1.875	2.625	0.375	48	67	10	29519-1075	IG	1.875	2.750	0.625	48	70	16
24060-1042	61	1.875	2.625	0.375	48	67	10	24801-1075	EQUAL	1.875	2.750	0.625	48	70	16
21702-1042	62	1.875	2.625	0.375	48	67	10	24802-1075	EQUAL	1.875	2.750	0.625	48	70	16
21173-1042	63	1.875	2.625	0.375	48	67	10	23548-8643	63R2	1.875	2.750	0.687	48	70	17
21290-1042	63	1.875	2.625	0.375	48	67	10	29602-4110	GD	1.875	2.750	0.700	48	70	18
21159-1042	63	1.875	2.625	0.375	48	67	10	29500-4110	IG	1.875	2.750	0.750	48	70	19
21158-1042	63	1.875	2.625	0.375	48	67	10	29502-4110	IG	1.875	2.750	0.750	48	70	19
21695-1042	63	1.875	2.625	0.375	48	67	10	29503-4110	IG	1.875	2.750	0.750	48	70	19
21527-1042	66	1.875	2.625	0.375	48	67	10	29502-6975	IG	1.875	2.755	0.750	48	70	19
21370-1042	66	1.875	2.625	0.375	48	67	10	21158-1051	63	1.875	2.756	0.375	48	70	10
21158-1043	63	1.875	2.625	0.437	48	67	11	21695-1051	63	1.875	2.756	0.375	48	70	10
24078-1043	61	1.875	2.625	0.438	48	67	11	21527-1051	66	1.875	2.756	0.375	48	70	10
24062-1043	61	1.875	2.625	0.438	48	67	11	21158-1052	63	1.875	2.756	0.437	48	70	11
21158-1044	63	1.875	2.625	0.500	48	67	13	21158-1053	63	1.875	2.756	0.500	48	70	13
21168-1044	63	1.875	2.625	0.500	48	67	13	24801-3506	EQUAL	1.875	2.758	0.625	48	70	16
21695-1044	63	1.875	2.625	0.500	48	67	13	24802-3506	EQUAL	1.875	2.758	0.625	48	70	16
24801-0748	EQUAL	1.875	2.625	0.500	48	67	13	21795-1054	63	1.875	2.783	0.375	48	71	10
24802-0748	EQUAL	1.875	2.625	0.500	48	67	13	24801-1072	EQUAL	1.875	2.813	0.500	48	71	13
29507-0989	IG	1.875	2.625	0.625	48	67	16	24620-7164	26R1	1.875	2.835	0.375	48	72	10
29519-0989	IG	1.875	2.625	0.625	48	67	16	24060-7164	61	1.875	2.835	0.375	48	72	10
29619-6996	GD	1.875	2.625	0.625	48	67	16	21158-7164	63	1.875	2.835	0.375	48	72	10
24801-0989	EQUAL	1.875	2.625	0.625	48	67	16	24600-0622	26	1.875	2.875	0.313	48	73	8
24802-0989	EQUAL	1.875	2.625	0.625	48	67	16	24060-1057	61	1.875	2.875	0.375	48	73	10
24805-0989	EQUAL	1.875	2.625	0.625	48	67	16	21159-1057	63	1.875	2.875	0.375	48	73	10
24822-0989	EQUAL	1.875	2.625	0.625	48	67	16	21475-1057	63	1.875	2.875	0.375	48	73	10
24829-0989	EQUAL	1.875	2.625	0.625	48	67	16	21158-1057	63	1.875	2.875	0.375	48	73	10
24831-0989	EQUAL	1.875	2.625	0.625	48	67	16	21695-1057	63	1.875	2.875	0.375	48	73	10
24848-0989	EQUAL	1.875	2.625	0.625	48	67	16	21158-1058	63	1.875	2.875	0.437	48	73	11
24836-3325	EQUAL	1.875	2.625	0.670	48	67	17	24627-1059	26	1.875	2.875	0.500	48	73	13
23548-6546	63R2	1.875	2.625	0.688	48	67	17	24060-1059	61	1.875	2.875	0.500	48	73	13
23550-6546	63T2	1.875	2.625	0.688	48	67	17	21159-1059	63	1.875	2.875	0.500	48	73	13
24806-2220	EQUAL	1.875	2.625	0.688	48	67	17	21158-1059	63	1.875	2.875	0.500	48	73	13
24807-3343	EQUAL	1.875	2.625	0.690	48	67	18	24801-1059	EQUAL	1.875	2.875	0.500	48	73	13
29602-4124	GD	1.875	2.625	0.700	48	67	18	29519-0792	IG	1.875	2.875	0.625	48	73	16
29500-4124	IG	1.875	2.625	0.750	48	67	19	24801-0792	EQUAL	1.875	2.875	0.625	48	73	16
29502-4124	IG	1.875	2.625	0.750	48	67	19	24802-0792	EQUAL	1.875	2.875	0.625	48	73	16
29526-4124	IG	1.875	2.625	0.750	48	67	19	24805-0792	EQUAL	1.875	2.875	0.625	48	73	16
21158-1045	63	1.875	2.686	0.375	48	68	10	23548-8293	63R2	1.875	2.875	0.688	48	73	17
21702-1046	62	1.875	2.686	0.437	48	68	11	29602-3585	GD	1.875	2.875	0.700	48	73	18
21158-1047	63	1.875	2.686	0.500	48	68	13	29620-3585	GD	1.875	2.875	0.700	48	73	18
29602-4330	GD	1.875	2.686	0.700	48	68	18	29500-3585	IG	1.875	2.875	0.750	48	73	19
29502-4330	IG	1.875	2.686	0.750	48	68	19	29502-3585	IG	1.875	2.875	0.750	48	73	19
24610-3481	26	1.875	2.688	0.469	48	68	12	29520-3585	IG	1.875	2.875	0.750	48	73	19
24610-3977	26	1.875	2.750	0.375	48	70	10	29529-3585	IG	1.875	2.875	0.750	48	73	19
24060-1048	61	1.875	2.750	0.375	48	70	10	21158-1060	63	1.875	2.997	0.375	48	76	10
21767-1048	62	1.875	2.750	0.375	48	70	10	24802-1891	EQUAL	1.875	2.997	0.625	48	76	16
21702-1048	62	1.875	2.750	0.375	48	70	10	24626-1063	26	1.875	3.000	0.375	48	76	10
21159-1048	63	1.875	2.750	0.375	48	70	10	24600-1063	26	1.875	3.000	0.375	48	76	10
21158-1048	63	1.875	2.750	0.375	48	70	10	24060-1063	61	1.875	3.000	0.375	48	76	10
21542-1048	63	1.875	2.750	0.375	48	70	10	21158-1063	63	1.875	3.000	0.375	48	76	10

All dimensions are in inches. Preferred sizes are indicated with **bold** type face.

Sizes listed are for standard nitrile elements, except Models 25 and 62 which have PTFE elements. Other material available on inquiry only.

## Oil Seals by Model Number

Product Code	Model	Inches			MM			Product Code	Model	Inches			MM		
		ID	OD	Width	ID	OD	Width			ID	OD	Width	ID	OD	Width
21695-1063	63	1.875	3.000	0.375	48	76	10	29502-4189	IG	1.890	2.756	0.750	48	70	19
21789-1063	66	1.875	3.000	0.375	48	76	10	29507-4943	IG	1.890	2.835	0.625	48	72	16
21528-1063	67	1.875	3.000	0.375	48	76	10	24802-4943	EQUAL	1.890	2.835	0.625	48	72	16
21158-1065	63	1.875	3.000	0.500	48	76	13	29502-3443	IG	1.890	2.835	0.750	48	72	19
21158-8258	63	1.875	3.000	0.562	48	76	14	29520-6622	IG	1.891	2.896	0.750	48	74	19
21463-8258	66	1.875	3.000	0.563	48	76	14	24627-5557	26	1.897	2.835	0.375	48	72	10
23078-2967	63F1	1.875	3.000	0.594	48	76	15	24610-5557	26	1.897	2.835	0.375	48	72	10
29507-0706	IG	1.875	3.000	0.625	48	76	16	29602-4356	GD	1.900	3.500	0.700	48	89	18
24801-0706	EQUAL	1.875	3.000	0.625	48	76	16	29502-4356	IG	1.900	3.500	0.750	48	89	19
24802-0706	EQUAL	1.875	3.000	0.625	48	76	16	21158-1084	63	1.906	2.750	0.375	48	70	10
29500-4809	IG	1.875	3.000	0.750	48	76	19	29502-5753	IG	1.906	2.752	0.750	48	70	19
29502-4809	IG	1.875	3.000	0.750	48	76	19	21158-1093	63	1.906	2.875	0.375	48	73	10
21158-1066	63	1.875	3.062	0.375	48	78	10	24802-2920	EQUAL	1.908	2.875	0.625	48	73	16
21527-1066	66	1.875	3.062	0.375	48	78	10	29502-4716	IG	1.920	3.000	0.750	49	76	19
21900-1066	66	1.875	3.062	0.375	48	78	10	24060-2514	61	1.922	2.875	0.438	49	73	11
21159-1069	63	1.875	3.125	0.375	48	79	10	29607-7241	GD	1.925	2.500	0.625	49	64	16
21475-1069	63	1.875	3.125	0.375	48	79	10	29502-4664	IG	1.925	3.000	0.750	49	76	19
21158-1069	63	1.875	3.125	0.375	48	79	10	24807-2495	EQUAL	1.932	2.625	0.690	49	67	18
21158-1071	63	1.875	3.125	0.500	48	79	13	24801-2038	EQUAL	1.932	2.750	0.625	49	70	16
29502-5040	IG	1.875	3.125	0.750	48	79	19	24802-2038	EQUAL	1.932	2.750	0.625	49	70	16
29518-6912	IG	1.875	3.125	0.875	48	79	22	24802-4521	EQUAL	1.932	2.806	0.625	49	71	16
21158-3888	63	1.875	3.149	0.375	48	80	10	29502-5961	IG	1.932	2.875	0.750	49	73	19
21500-3888	63	1.875	3.149	0.375	48	80	10	24802-3290	EQUAL	1.932	2.932	0.625	49	74	16
21695-3888	63	1.875	3.149	0.375	48	80	10	23704-7721	52	1.933	2.441	0.625	49	62	16
21527-3888	66	1.875	3.149	0.375	48	80	10	24829-2956	EQUAL	1.933	2.735	0.625	49	69	16
29519-6208	IG	1.875	3.150	0.625	48	80	16	29507-4889	IG	1.936	2.367	0.625	49	60	16
29502-6332	IG	1.875	3.188	0.750	48	81	19	24060-1117	61	1.936	2.686	0.375	49	68	10
21158-1075	63	1.875	3.189	0.375	48	81	10	24077-1117	61	1.936	2.686	0.375	49	68	10
21695-1076	63	1.875	3.189	0.437	48	81	11	24600-1114	26	1.937	2.625	0.375	49	67	10
24060-1076	61	1.875	3.189	0.438	48	81	11	21702-1117	62	1.937	2.686	0.375	49	68	10
23549-8292	63TB	1.875	3.189	0.688	48	81	17	21158-1119	63	1.937	2.686	0.500	49	68	13
29500-4571	IG	1.875	3.250	0.750	48	83	19	29602-7247	GD	1.937	2.734	0.700	49	69	18
29502-6692	IG	1.875	3.340	0.750	48	85	19	24610-1120	26	1.937	2.750	0.375	49	70	10
29520-5660	IG	1.875	3.500	0.750	48	89	19	29502-5274	IG	1.937	2.750	0.750	49	70	19
24600-1067	26	1.875	3.543	0.375	48	90	10	21158-1128	63	1.937	2.783	0.500	49	71	13
29502-6137	IG	1.875	3.543	0.750	48	90	19	21158-1130	63	1.937	2.875	0.437	49	73	11
29602-4704	GD	1.875	3.938	0.700	48	100	18	21158-1136	63	1.937	3.000	0.437	49	76	11
29500-4704	IG	1.875	3.938	0.750	48	100	19	24610-1137	26	1.937	3.000	0.500	49	76	13
29502-4704	IG	1.875	3.938	0.750	48	100	19	23547-6469	63R1	1.937	3.000	0.687	49	76	17
29519-6709	IG	1.875	4.312	0.625	48	110	16	29500-4120	IG	1.937	3.000	0.750	49	76	19
29602-4729	GD	1.875	5.000	0.700	48	127	18	21158-1142	63	1.937	3.125	0.437	49	79	11
29507-5363	IG	1.878	2.754	0.625	48	70	16	21158-1143	63	1.937	3.125	0.500	49	79	13
29507-5518	IG	1.880	2.625	0.625	48	67	16	26001-7085	71	1.938	2.375	0.188	49	60	5
24620-5451	26R1	1.885	2.700	0.500	48	69	13	29507-5547	IG	1.938	2.412	0.625	49	61	16
24802-3264	EQUAL	1.886	2.886	0.625	48	73	16	29507-6230	IG	1.938	2.416	0.625	49	61	16
29500-6491	IG	1.889	2.828	0.750	48	72	19	26193-9768	76	1.938	2.438	0.313	49	62	8
29507-5270	IG	1.889	2.874	0.625	48	73	16	24807-2882	EQUAL	1.938	2.438	0.690	49	62	18
29519-5270	IG	1.889	2.874	0.625	48	73	16	24650-1111	26NS	1.938	2.500	0.375	49	64	10
24802-3745	EQUAL	1.889	2.889	0.625	48	73	16	24600-1111	26	1.938	2.500	0.375	49	64	10
29606-4942	GD	1.890	2.441	0.625	48	62	16	24060-2478	61	1.938	2.500	0.375	49	64	10
24060-0534	61	1.890	2.559	0.394	48	65	10	29507-5703	IG	1.938	2.500	0.625	49	64	16
29507-6586	IG	1.890	2.559	0.625	48	65	16	24807-3413	EQUAL	1.938	2.500	0.690	49	64	18
24807-2681	EQUAL	1.890	2.559	0.690	48	65	18	24816-7041	EQUAL	1.938	2.563	0.875	49	65	22
24620-1079	26R1	1.890	2.750	0.470	48	70	12	29516-7092	IG	1.938	2.563	0.943	49	65	24
24802-1935	EQUAL	1.890	2.756	0.625	48	70	16	29616-7092	GD	1.938	2.563	1.173	49	65	30
29602-4189	GD	1.890	2.756	0.700	48	70	18	24816-7019	EQUAL	1.938	2.567	0.875	49	65	22

All dimensions are in inches. Preferred sizes are indicated with **bold** type face. Sizes listed are for standard nitrile elements, except Models 25 and 62 which have PTFE elements. Other material available on inquiry only.

## Oil Seals by Model Number

Product Code	Model	Inches			MM			Product Code	Model	Inches			MM		
		ID	OD	Width	ID	OD	Width			ID	OD	Width	ID	OD	Width
29507-5129	IG	1.938	2.623	0.625	49	67	16	21702-1135	62	1.938	3.000	0.375	49	76	10
24063-1114	61	1.938	2.625	0.375	49	67	10	21294-1135	63	1.938	3.000	0.375	49	76	10
21702-1114	62	1.938	2.625	0.375	49	67	10	21290-1135	63	1.938	3.000	0.375	49	76	10
21159-1114	63	1.938	2.625	0.375	49	67	10	21159-1135	63	1.938	3.000	0.375	49	76	10
21158-1114	63	1.938	2.625	0.375	49	67	10	21158-1135	63	1.938	3.000	0.375	49	76	10
21695-1114	63	1.938	2.625	0.375	49	67	10	21500-1135	63	1.938	3.000	0.375	49	76	10
21158-1116	63	1.938	2.625	0.500	49	67	13	21163-1135	63	1.938	3.000	0.375	49	76	10
29507-6112	IG	1.938	2.625	0.625	49	67	16	24600-1125	26	1.938	3.000	0.438	49	76	11
23548-7223	63R2	1.938	2.625	0.688	49	67	17	24600-1137	26	1.938	3.000	0.500	49	76	13
23550-7223	63T2	1.938	2.625	0.688	49	67	17	21158-1137	63	1.938	3.000	0.500	49	76	13
21160-1114	63	1.938	2.631	0.375	49	67	10	29519-1123	IG	1.938	3.000	0.625	49	76	16
21158-1117	63	1.938	2.686	0.375	49	68	10	24802-1123	EQUAL	1.938	3.000	0.625	49	76	16
21527-1117	66	1.938	2.686	0.375	49	68	10	23550-6469	63T2	1.938	3.000	0.688	49	76	17
24824-3652	EQUAL	1.938	2.688	0.625	49	68	16	29602-4120	GD	1.938	3.000	0.700	49	76	18
29500-5713	IG	1.938	2.688	0.750	49	68	19	29620-4120	GD	1.938	3.000	0.700	49	76	18
29502-5713	IG	1.938	2.688	0.750	49	68	19	29502-4120	IG	1.938	3.000	0.750	49	76	19
24075-3016	61	1.938	2.750	0.312	49	70	8	21158-1138	63	1.938	3.062	0.375	49	78	10
24060-1120	61	1.938	2.750	0.375	49	70	10	21158-1140	63	1.938	3.062	0.500	49	78	13
21290-1120	63	1.938	2.750	0.375	49	70	10	21158-1141	63	1.938	3.125	0.375	49	79	10
21159-1120	63	1.938	2.750	0.375	49	70	10	21168-1141	63	1.938	3.125	0.375	49	79	10
21300-1120	63	1.938	2.750	0.375	49	70	10	21527-1141	66	1.938	3.125	0.375	49	79	10
21158-1120	63	1.938	2.750	0.375	49	70	10	24802-2108	EQUAL	1.938	3.125	0.625	49	79	16
24062-2821	61	1.938	2.750	0.438	49	70	11	29502-6043	IG	1.938	3.125	0.750	49	79	19
24063-2821	61	1.938	2.750	0.438	49	70	11	21158-1144	63	1.938	3.147	0.375	49	80	10
24627-3666	26	1.938	2.750	0.500	49	70	13	21527-1144	66	1.938	3.147	0.375	49	80	10
29512-1862	IG	1.938	2.750	0.625	49	70	16	29502-5570	IG	1.938	3.149	0.750	49	80	19
24801-1862	EQUAL	1.938	2.750	0.625	49	70	16	24600-1126	26	1.938	3.188	0.469	49	81	12
24802-1862	EQUAL	1.938	2.750	0.625	49	70	16	24600-1149	26	1.938	3.188	0.500	49	81	13
21158-1123	63	1.938	2.756	0.375	49	70	10	21158-1147	63	1.938	3.189	0.375	49	81	10
24610-3591	26	1.938	2.813	0.500	49	71	13	24620-3308	26R1	1.938	3.250	0.375	49	83	10
24802-1141	EQUAL	1.938	2.813	0.625	49	71	16	24600-3308	26	1.938	3.250	0.375	49	83	10
21158-4930	63	1.938	2.835	0.375	49	72	10	29519-6580	IG	1.938	3.350	0.625	49	85	16
24626-4520	26	1.938	2.875	0.313	49	73	8	29519-6593	IG	1.938	3.543	0.625	49	90	16
24060-1129	61	1.938	2.875	0.375	49	73	10	27223-6266	94	1.938	3.544	0.375	49	90	10
21767-1129	62	1.938	2.875	0.375	49	73	10	24620-1109	26R1	1.938	3.548	0.375	49	90	10
21159-1129	63	1.938	2.875	0.375	49	73	10	29502-6443	IG	1.945	2.756	0.750	49	70	19
21158-1129	63	1.938	2.875	0.375	49	73	10	24620-3715	26R1	1.949	3.031	0.709	50	77	18
21542-1129	63	1.938	2.875	0.375	49	73	10	26056-4214	57	1.949	3.031	0.709	50	77	18
21795-1129	63	1.938	2.875	0.375	49	73	10	29519-6195	IG	1.950	2.700	0.625	50	69	16
21159-1130	63	1.938	2.875	0.437	49	73	11	29502-4688	IG	1.950	3.000	0.750	50	76	19
24600-1130	26	1.938	2.875	0.438	49	73	11	29502-6058	IG	1.950	3.250	0.750	50	83	19
24602-1130	26	1.938	2.875	0.438	49	73	11	29502-4591	IG	1.962	2.962	0.750	50	75	19
21158-1131	63	1.938	2.875	0.500	49	73	13	24600-1155	26	1.962	3.188	0.469	50	81	12
24820-4037	EQUAL	1.938	2.875	0.500	49	73	13	21702-1155	62	1.962	3.188	0.469	50	81	12
24802-1743	EQUAL	1.938	2.875	0.625	49	73	16	29519-6160	IG	1.965	2.756	0.625	50	70	16
29502-4714	IG	1.938	2.875	0.750	49	73	19	24812-2092	EQUAL	1.965	2.875	0.625	50	73	16
24610-3507	26	1.938	2.938	0.438	49	75	11	24809-3510	EQUAL	1.965	2.965	0.625	50	75	16
24610-0641	26	1.938	2.938	0.500	49	75	13	29502-4665	IG	1.965	3.000	0.750	50	76	19
24802-2730	EQUAL	1.938	2.938	0.625	49	75	16	29502-6162	IG	1.965	3.543	0.750	50	90	19
29602-4277	GD	1.938	2.938	0.700	49	75	18	24805-2960	EQUAL	1.967	2.955	0.625	50	75	16
29502-4277	IG	1.938	2.938	0.750	49	75	19	29505-5789	IG	1.967	2.967	0.500	50	75	13
29502-6350	IG	1.938	2.969	0.750	49	75	19	29507-3266	IG	1.967	2.967	0.625	50	75	16
29516-7160	IG	1.938	2.972	0.725	49	75	18	29519-3266	IG	1.967	2.967	0.625	50	75	16
29519-6863	IG	1.938	2.996	0.625	49	76	16	24802-3266	EQUAL	1.967	2.967	0.625	50	75	16
21158-1132	63	1.938	2.997	0.375	49	76	10	29502-5168	IG	1.967	2.967	0.750	50	75	19
21158-1134	63	1.938	2.997	0.500	49	76	13	29502-4880	IG	1.968	2.718	0.750	50	69	19

All dimensions are in inches. Preferred sizes are indicated with **bold** type face.

Sizes listed are for standard nitrile elements, except Models 25 and 62 which have PTFE elements. Other material available on inquiry only.

## Oil Seals by Model Number

Product Code	Model	Inches			MM			Product Code	Model	Inches			MM		
		ID	OD	Width	ID	OD	Width			ID	OD	Width	ID	OD	Width
24824-3381	EQUAL	1.968	2.719	0.625	50	69	16	21158-6656	63	1.969	2.835	0.375	50	72	10
24802-1760	EQUAL	1.968	2.875	0.625	50	73	16	24060-2902	61	1.969	2.835	0.394	50	72	10
24802-2480	EQUAL	1.968	2.935	0.625	50	75	16	29502-6168	IG	1.969	2.835	0.750	50	72	19
24801-1127	EQUAL	1.968	2.952	0.500	50	75	13	29520-6168	IG	1.969	2.835	0.750	50	72	19
24802-1197	EQUAL	1.968	2.953	0.625	50	75	16	29502-6841	IG	1.969	2.839	0.750	50	72	19
24610-1928	26	1.968	2.968	0.375	50	75	10	21158-1162	63	1.969	2.875	0.375	50	73	10
24629-7654	26R1	1.969	2.559	0.354	50	65	9	24060-2422	61	1.969	2.953	0.315	50	75	8
24620-7654	26R1	1.969	2.559	0.354	50	65	9	29507-6133	IG	1.969	2.953	0.625	50	75	16
24060-1814	61	1.969	2.559	0.394	50	65	10	29502-4700	IG	1.969	2.953	0.750	50	75	19
24056-1814	61	1.969	2.559	0.394	50	65	10	29502-6196	IG	1.969	2.960	0.750	50	75	19
24064-1814	61	1.969	2.559	0.394	50	65	10	29516-7218	IG	1.969	2.972	0.725	50	75	18
24629-1108	26R1	1.969	2.677	0.354	50	68	9	29516-7176	IG	1.969	2.972	0.768	50	75	20
24620-1108	26R1	1.969	2.677	0.354	50	68	9	29507-6098	IG	1.969	2.992	0.625	50	76	16
24622-1108	26R1	1.969	2.677	0.354	50	68	9	29602-5632	GD	1.969	2.992	0.700	50	76	18
24602-1187	26	1.969	2.835	0.315	50	72	8	29502-5632	IG	1.969	2.992	0.750	50	76	19
21003-2902	58	1.969	2.835	0.394	50	72	10	21702-1168	62	1.969	3.000	0.375	50	76	10
24620-1107	26R1	1.969	2.835	0.472	50	72	12	21158-1168	63	1.969	3.000	0.375	50	76	10
24062-3166	61	1.969	2.835	0.472	50	72	12	21527-1168	66	1.969	3.000	0.375	50	76	10
24801-4947	EQUAL	1.969	2.835	0.630	50	72	16	21158-1170	63	1.969	3.000	0.500	50	76	13
24600-1103	26	1.969	3.150	0.315	50	80	8	21158-0687	63	1.969	3.062	0.375	50	78	10
24125-2602	61	1.969	3.150	0.394	50	80	10	21158-1174	63	1.969	3.125	0.375	50	79	10
29621-7252	GD	1.969	2.345	0.625	50	60	16	24821-1596	EQUAL	1.969	3.125	0.500	50	79	13
24622-1106	26R1	1.969	2.441	0.276	50	62	7	24822-1596	EQUAL	1.969	3.125	0.500	50	79	13
29507-6328	IG	1.969	2.441	0.625	50	62	16	21158-1177	63	1.969	3.147	0.375	50	80	10
24125-1814	61	1.969	2.559	0.394	50	65	10	24626-1103	26	1.969	3.150	0.315	50	80	8
29507-4944	IG	1.969	2.559	0.625	50	65	16	24060-7415	61	1.969	3.150	0.375	50	80	10
29606-7255	GD	1.969	2.559	0.625	50	65	16	21158-7415	63	1.969	3.150	0.375	50	80	10
29607-7255	GD	1.969	2.559	0.625	50	65	16	29519-1975	IG	1.969	3.150	0.625	50	80	16
24807-3431	EQUAL	1.969	2.559	0.690	50	65	18	24802-1975	EQUAL	1.969	3.150	0.625	50	80	16
24807-2155	EQUAL	1.969	2.638	0.690	50	67	18	29602-7256	GD	1.969	3.150	0.700	50	80	18
29507-4945	IG	1.969	2.677	0.625	50	68	16	29604-7256	GD	1.969	3.150	0.700	50	80	18
24807-1846	EQUAL	1.969	2.677	0.690	50	68	18	21158-1180	63	1.969	3.189	0.375	50	81	10
24857-1846	EQUAL	1.969	2.677	0.690	50	68	18	24801-2969	EQUAL	1.969	3.189	0.625	50	81	16
21702-1150	62	1.969	2.686	0.375	50	68	10	29524-5822	IG	1.969	3.189	0.750	50	81	19
21294-1150	63	1.969	2.686	0.375	50	68	10	21158-1183	63	1.969	3.246	0.375	50	82	10
21158-1150	63	1.969	2.686	0.375	50	68	10	21158-1185	63	1.969	3.246	0.500	50	82	13
21527-1150	66	1.969	2.686	0.375	50	68	10	24060-2082	61	1.969	3.250	0.437	50	83	11
29507-5554	IG	1.969	2.690	0.625	50	68	16	29516-7199	IG	1.969	3.366	0.764	50	85	19
24060-1153	61	1.969	2.750	0.375	50	70	10	24620-1953	26R1	1.969	3.543	0.394	50	90	10
21158-1153	63	1.969	2.750	0.375	50	70	10	26193-0373	76	1.969	3.543	0.394	50	90	10
21158-1154	63	1.969	2.750	0.438	50	70	11	24802-3600	EQUAL	1.969	3.543	0.625	50	90	16
24069-1156	61	1.969	2.756	0.375	50	70	10	29502-4553	IG	1.969	3.543	0.750	50	90	19
21158-1156	63	1.969	2.756	0.375	50	70	10	24620-2621	26R1	1.969	4.331	0.375	50	110	10
21527-1156	66	1.969	2.756	0.375	50	70	10	24600-2621	26	1.969	4.331	0.375	50	110	10
24600-1104	26	1.969	2.756	0.394	50	70	10	27223-8005	94	1.969	4.331	0.375	50	110	10
24612-1104	26	1.969	2.756	0.394	50	70	10	29507-6846	IG	1.970	2.360	0.625	50	60	16
24060-1156	61	1.969	2.756	0.394	50	70	10	29607-6846	GD	1.970	2.360	0.625	50	60	16
24610-3401	26	1.969	2.756	0.500	50	70	13	29609-7240	GD	1.970	2.715	0.375	50	69	10
29519-3225	IG	1.969	2.756	0.625	50	70	16	25284-0754	23	1.975	2.850	0.625	50	72	16
24801-3225	EQUAL	1.969	2.756	0.625	50	70	16	29502-7521	IG	1.979	2.884	0.750	50	73	19
24807-3229	EQUAL	1.969	2.756	0.690	50	70	18	24802-3524	EQUAL	1.980	2.875	0.625	50	73	16
29602-4819	GD	1.969	2.756	0.700	50	70	18	29507-5318	IG	1.998	2.500	0.625	51	64	16
29502-4819	IG	1.969	2.756	0.750	50	70	19	29502-6538	IG	1.998	3.062	0.750	51	78	19
29520-4819	IG	1.969	2.756	0.750	50	70	19	26001-6267	71	2.000	2.250	0.109	51	57	3
24060-0571	61	1.969	2.835	0.315	50	72	8	26001-7530	71	2.000	2.375	0.188	51	60	5
24060-6656	61	1.969	2.835	0.375	50	72	10	26193-7530	76	2.000	2.375	0.188	51	60	5

All dimensions are in inches. Preferred sizes are indicated with **bold** type face.  
 Sizes listed are for standard nitrile elements, except Models 25 and 62 which have PTFE elements. Other material available on inquiry only.

## Oil Seals by Model Number

Product Code	Model	Inches			MM			Product Code	Model	Inches			MM		
		ID	OD	Width	ID	OD	Width			ID	OD	Width	ID	OD	Width
29507-5744	IG	2.000	2.375	0.625	51	60	16	21370-1189	66	2.000	2.750	0.375	51	70	10
24614-1047	26	2.000	2.500	0.250	51	64	6	21528-1189	67	2.000	2.750	0.375	51	70	10
24060-1421	61	2.000	2.500	0.375	51	64	10	21823-1189	68	2.000	2.750	0.375	51	70	10
29507-5502	IG	2.000	2.500	0.625	51	64	16	24060-1190	61	2.000	2.750	0.437	51	70	11
24807-2336	EQUAL	2.000	2.500	0.690	51	64	18	24600-1190	26	2.000	2.750	0.438	51	70	11
24614-4582	26	2.000	2.625	0.312	51	67	8	24063-1190	61	2.000	2.750	0.438	51	70	11
24060-4582	61	2.000	2.625	0.312	51	67	8	24600-1191	26	2.000	2.750	0.500	51	70	13
21767-4582	62	2.000	2.625	0.312	51	67	8	24062-1191	61	2.000	2.750	0.500	51	70	13
24600-4582	26	2.000	2.625	0.313	51	67	8	24063-1191	61	2.000	2.750	0.500	51	70	13
24125-1427	61	2.000	2.625	0.375	51	67	10	21702-1191	62	2.000	2.750	0.500	51	70	13
24062-3513	61	2.000	2.625	0.438	51	67	11	21158-1191	63	2.000	2.750	0.500	51	70	13
29507-4539	IG	2.000	2.625	0.625	51	67	16	23078-5283	63F1	2.000	2.750	0.625	51	70	16
29607-4539	GD	2.000	2.625	0.625	51	67	16	29507-1249	IG	2.000	2.750	0.625	51	70	16
24807-4851	EQUAL	2.000	2.670	0.690	51	68	18	29519-1249	IG	2.000	2.750	0.625	51	70	16
24060-1186	61	2.000	2.686	0.375	51	68	10	29607-1249	GD	2.000	2.750	0.625	51	70	16
24077-1186	61	2.000	2.686	0.375	51	68	10	24801-1249	EQUAL	2.000	2.750	0.625	51	70	16
21702-1186	62	2.000	2.686	0.375	51	68	10	24802-1249	EQUAL	2.000	2.750	0.625	51	70	16
21290-1186	63	2.000	2.686	0.375	51	68	10	24824-1249	EQUAL	2.000	2.750	0.625	51	70	16
21159-1186	63	2.000	2.686	0.375	51	68	10	23547-7563	63R1	2.000	2.750	0.688	51	70	17
21158-1186	63	2.000	2.686	0.375	51	68	10	23548-7563	63R2	2.000	2.750	0.688	51	70	17
21163-1186	63	2.000	2.686	0.375	51	68	10	23626-7563	63T2	2.000	2.750	0.688	51	70	17
21164-1186	63	2.000	2.686	0.375	51	68	10	23550-7563	63T2	2.000	2.750	0.688	51	70	17
21695-1186	63	2.000	2.686	0.375	51	68	10	24847-2833	EQUAL	2.000	2.750	0.690	51	70	18
21158-1187	63	2.000	2.686	0.437	51	68	11	29602-4326	GD	2.000	2.750	0.700	51	70	18
21158-1188	63	2.000	2.686	0.500	51	68	13	29502-4326	IG	2.000	2.750	0.750	51	70	19
23548-6608	63R2	2.000	2.686	0.688	51	68	17	29520-4326	IG	2.000	2.750	0.750	51	70	19
24807-3297	EQUAL	2.000	2.690	0.690	51	68	18	21158-1192	63	2.000	2.756	0.375	51	70	10
24807-1361	EQUAL	2.000	2.710	0.690	51	69	18	21158-1193	63	2.000	2.756	0.437	51	70	11
29507-5151	IG	2.000	2.712	0.625	51	69	16	21158-1194	63	2.000	2.756	0.500	51	70	13
24600-1173	26	2.000	2.715	0.438	51	69	11	29502-6305	IG	2.000	2.775	0.750	51	70	19
21695-1197	63	2.000	2.716	0.375	51	69	10	24600-1195	26	2.000	2.783	0.375	51	71	10
21158-1197	63	2.000	2.716	0.375	51	69	10	21158-1195	63	2.000	2.783	0.375	51	71	10
29507-6898	IG	2.000	2.716	0.625	51	69	16	21158-1196	63	2.000	2.783	0.437	51	71	11
24807-4677	EQUAL	2.000	2.716	0.690	51	69	18	24610-3274	26	2.000	2.813	0.500	51	71	13
24610-3262	26	2.000	2.738	0.375	51	70	10	21158-8111	63	2.000	2.835	0.375	51	72	10
21158-1211	63	2.000	2.745	0.375	51	70	10	24802-3560	EQUAL	2.000	2.855	0.625	51	73	16
24060-2589	61	2.000	2.750	0.250	51	70	6	24600-1198	26	2.000	2.875	0.375	51	73	10
24075-1431	61	2.000	2.750	0.312	51	70	8	24060-1198	61	2.000	2.875	0.375	51	73	10
24060-1431	61	2.000	2.750	0.312	51	70	8	24077-1198	61	2.000	2.875	0.375	51	73	10
25058-1189	25	2.000	2.750	0.375	51	70	10	21290-1198	63	2.000	2.875	0.375	51	73	10
24620-1189	26R1	2.000	2.750	0.375	51	70	10	21158-1198	63	2.000	2.875	0.375	51	73	10
24610-1189	26	2.000	2.750	0.375	51	70	10	21695-1198	63	2.000	2.875	0.375	51	73	10
24627-1972	26	2.000	2.750	0.375	51	70	10	21158-1199	63	2.000	2.875	0.437	51	73	11
24610-1972	26	2.000	2.750	0.375	51	70	10	24610-1200	26	2.000	2.875	0.500	51	73	13
24602-1972	26	2.000	2.750	0.375	51	70	10	24062-1200	61	2.000	2.875	0.500	51	73	13
21003-1189	58	2.000	2.750	0.375	51	70	10	21158-1200	63	2.000	2.875	0.500	51	73	13
24060-1189	61	2.000	2.750	0.375	51	70	10	21695-1200	63	2.000	2.875	0.500	51	73	13
21767-1189	62	2.000	2.750	0.375	51	70	10	29507-1406	IG	2.000	2.875	0.625	51	73	16
21702-1189	62	2.000	2.750	0.375	51	70	10	24801-1406	EQUAL	2.000	2.875	0.625	51	73	16
21158-1189	63	2.000	2.750	0.375	51	70	10	24802-1406	EQUAL	2.000	2.875	0.625	51	73	16
21618-1189	63	2.000	2.750	0.375	51	70	10	23548-4670	63R2	2.000	2.875	0.688	51	73	17
21168-1189	63	2.000	2.750	0.375	51	70	10	23550-4670	63T2	2.000	2.875	0.688	51	73	17
21695-1189	63	2.000	2.750	0.375	51	70	10	29502-4781	IG	2.000	2.875	0.750	51	73	19
21928-1189	63	2.000	2.750	0.375	51	70	10	23550-5778	63T2	2.000	2.882	0.687	51	73	17
21920-1189	66	2.000	2.750	0.375	51	70	10	24802-3541	EQUAL	2.000	2.884	0.625	51	73	16
21527-1189	66	2.000	2.750	0.375	51	70	10	29502-6179	IG	2.000	2.900	0.750	51	74	19

All dimensions are in inches. Preferred sizes are indicated with **bold** type face.

Sizes listed are for standard nitrile elements, except Models 25 and 62 which have PTFE elements. Other material available on inquiry only.

## Oil Seals by Model Number

Product Code	Model	Inches			MM			Product Code	Model	Inches			MM		
		ID	OD	Width	ID	OD	Width			ID	OD	Width	ID	OD	Width
24610-3145	26	2.000	2.935	0.375	51	75	10	24850-1350	EQUAL	2.000	3.000	0.625	51	76	16
24620-1201	26R1	2.000	2.997	0.375	51	76	10	23547-6438	63R1	2.000	3.000	0.687	51	76	17
24602-1201	26	2.000	2.997	0.375	51	76	10	23548-6438	63R2	2.000	3.000	0.688	51	76	17
21158-1201	63	2.000	2.997	0.375	51	76	10	29602-3349	GD	2.000	3.000	0.700	51	76	18
21695-1201	63	2.000	2.997	0.375	51	76	10	29500-3349	IG	2.000	3.000	0.750	51	76	19
21158-1203	63	2.000	2.997	0.500	51	76	13	29502-3349	IG	2.000	3.000	0.750	51	76	19
23547-5568	63R1	2.000	2.997	0.687	51	76	17	29529-3349	IG	2.000	3.000	0.750	51	76	19
25003-1204	23	2.000	3.000	0.375	51	76	10	24802-3349	EQUAL	2.000	3.000	0.750	51	76	19
25006-1204	23	2.000	3.000	0.375	51	76	10	21158-1207	63	2.000	3.062	0.375	51	78	10
25009-1204	23	2.000	3.000	0.375	51	76	10	21695-1207	63	2.000	3.063	0.375	51	78	10
25058-1204	25	2.000	3.000	0.375	51	76	10	21016-1210	123	2.000	3.125	0.375	51	79	10
24652-1204	26NS	2.000	3.000	0.375	51	76	10	21695-1210	63	2.000	3.125	0.375	51	79	10
24626-1204	26	2.000	3.000	0.375	51	76	10	21158-1210	63	2.000	3.125	0.375	51	79	10
24600-1204	26	2.000	3.000	0.375	51	76	10	25003-1212	23	2.000	3.125	0.500	51	79	13
24610-1204	26	2.000	3.000	0.375	51	76	10	21158-1212	63	2.000	3.125	0.500	51	79	13
24060-1204	61	2.000	3.000	0.375	51	76	10	24801-2001	EQUAL	2.000	3.125	0.625	51	79	16
21767-1204	62	2.000	3.000	0.375	51	76	10	24802-2001	EQUAL	2.000	3.125	0.625	51	79	16
21702-1204	62	2.000	3.000	0.375	51	76	10	24803-2001	EQUAL	2.000	3.125	0.625	51	79	16
21290-1204	63	2.000	3.000	0.375	51	76	10	23548-5053	63R2	2.000	3.125	0.687	51	79	17
21391-1204	63	2.000	3.000	0.375	51	76	10	23550-5053	63T2	2.000	3.125	0.688	51	79	17
21475-1204	63	2.000	3.000	0.375	51	76	10	29620-4217	GD	2.000	3.125	0.700	51	79	18
21158-1204	63	2.000	3.000	0.375	51	76	10	29502-4217	IG	2.000	3.125	0.750	51	79	19
21372-1204	63	2.000	3.000	0.375	51	76	10	21158-1215	63	2.000	3.147	0.500	51	80	13
21173-1204	63	2.000	3.000	0.375	51	76	10	21158-8097	63	2.000	3.150	0.375	51	80	10
21177-1204	63	2.000	3.000	0.375	51	76	10	24600-1217	26	2.000	3.188	0.438	51	81	11
21893-1204	63	2.000	3.000	0.375	51	76	10	21158-1216	63	2.000	3.189	0.375	51	81	10
21168-1204	63	2.000	3.000	0.375	51	76	10	21158-1217	63	2.000	3.189	0.438	51	81	11
21695-1204	63	2.000	3.000	0.375	51	76	10	21158-1218	63	2.000	3.189	0.500	51	81	13
21528-1204	67	2.000	3.000	0.375	51	76	10	21158-1219	63	2.000	3.246	0.375	51	82	10
21823-1204	68	2.000	3.000	0.375	51	76	10	21500-1219	63	2.000	3.246	0.375	51	82	10
25058-1205	25	2.000	3.000	0.437	51	76	11	21695-1219	63	2.000	3.246	0.375	51	82	10
24060-1205	61	2.000	3.000	0.437	51	76	11	21158-1221	63	2.000	3.246	0.500	51	82	13
21475-1205	63	2.000	3.000	0.437	51	76	11	24060-4423	61	2.000	3.250	0.375	51	83	10
24610-2315	26	2.000	3.000	0.438	51	76	11	24062-1446	61	2.000	3.250	0.437	51	83	11
24062-1205	61	2.000	3.000	0.438	51	76	11	29500-5619	IG	2.000	3.250	0.750	51	83	19
21158-1205	63	2.000	3.000	0.438	51	76	11	29502-5619	IG	2.000	3.250	0.750	51	83	19
25003-1206	23	2.000	3.000	0.500	51	76	13	29516-7204	IG	2.000	3.366	0.745	51	85	19
25006-1206	23	2.000	3.000	0.500	51	76	13	24626-1182	26	2.000	3.375	0.375	51	86	10
25009-1206	23	2.000	3.000	0.500	51	76	13	24600-1182	26	2.000	3.375	0.375	51	86	10
25004-1206	23	2.000	3.000	0.500	51	76	13	24060-3892	61	2.000	3.375	0.500	51	86	13
24683-1206	26	2.000	3.000	0.500	51	76	13	21475-3892	63	2.000	3.375	0.500	51	86	13
24600-1206	26	2.000	3.000	0.500	51	76	13	21159-3892	63	2.000	3.375	0.500	51	86	13
24610-1206	26	2.000	3.000	0.500	51	76	13	21158-3892	63	2.000	3.375	0.500	51	86	13
21702-1206	62	2.000	3.000	0.500	51	76	13	29505-5937	IG	2.000	3.375	0.625	51	86	16
23501-1206	63G1	2.000	3.000	0.500	51	76	13	23548-6536	63R2	2.000	3.375	0.688	51	86	17
21475-1206	63	2.000	3.000	0.500	51	76	13	29519-5096	IG	2.000	3.500	0.625	51	89	16
21158-1206	63	2.000	3.000	0.500	51	76	13	24802-5096	EQUAL	2.000	3.500	0.625	51	89	16
21168-1206	63	2.000	3.000	0.500	51	76	13	29502-6181	IG	2.000	3.500	0.750	51	89	19
24801-1206	EQUAL	2.000	3.000	0.500	51	76	13	26193-7694	76	2.000	3.544	0.375	51	90	10
23078-6904	63F1	2.000	3.000	0.594	51	76	15	29602-6433	GD	2.000	4.000	0.700	51	102	18
23550-6904	63T2	2.000	3.000	0.594	51	76	15	29502-5160	IG	2.015	3.000	0.750	51	76	19
29507-1350	IG	2.000	3.000	0.625	51	76	16	29507-5651	IG	2.027	2.626	0.625	51	67	16
29519-1350	IG	2.000	3.000	0.625	51	76	16	21158-3893	63	2.031	2.783	0.375	52	71	10
24801-1350	EQUAL	2.000	3.000	0.625	51	76	16	21158-1228	63	2.031	3.000	0.375	52	76	10
24802-1350	EQUAL	2.000	3.000	0.625	51	76	16	21158-1231	63	2.031	3.062	0.375	52	78	10
24805-1350	EQUAL	2.000	3.000	0.625	51	76	16	21158-3896	63	2.031	3.150	0.344	52	80	9

All dimensions are in inches. Preferred sizes are indicated with **bold** type face.  
 Sizes listed are for standard nitrile elements, except Models 25 and 62 which have PTFE elements. Other material available on inquiry only.

## Oil Seals by Model Number

Product Code	Model	Inches			MM			Product Code	Model	Inches			MM		
		ID	OD	Width	ID	OD	Width			ID	OD	Width	ID	OD	Width
21158-1249	63	2.031	3.350	0.375	52	85	10	24801-1225	EQUAL	2.063	3.000	0.625	52	76	16
29507-4948	IG	2.047	2.677	0.625	52	68	16	24802-1225	EQUAL	2.063	3.000	0.625	52	76	16
24807-4713	EQUAL	2.047	2.750	0.690	52	70	18	29502-4119	IG	2.063	3.000	0.750	52	76	19
29502-6303	IG	2.047	2.835	0.750	52	72	19	24802-2735	EQUAL	2.063	3.063	0.625	52	78	16
24802-4660	EQUAL	2.047	2.953	0.625	52	75	16	29602-4278	GD	2.063	3.063	0.700	52	78	18
29502-6210	IG	2.047	3.000	0.750	52	76	19	29502-4278	IG	2.063	3.063	0.750	52	78	19
29502-5533	IG	2.047	3.150	0.750	52	80	19	29602-6512	GD	2.063	3.250	0.700	52	83	18
24829-5389	EQUAL	2.047	3.346	0.625	52	85	16	29502-6512	IG	2.063	3.250	0.750	52	83	19
29502-4489	IG	2.053	3.000	0.750	52	76	19	29502-6847	IG	2.063	3.500	0.750	52	89	19
24063-3956	61	2.058	2.750	0.438	52	70	11	29602-4335	GD	2.065	3.000	0.700	52	76	18
24802-3083	EQUAL	2.060	3.060	0.625	52	78	16	24802-4103	EQUAL	2.065	3.065	0.625	52	78	16
29602-6904	GD	2.060	3.200	0.700	52	81	18	29602-6793	GD	2.080	3.200	0.700	53	81	18
21702-1252	62	2.062	2.875	0.375	52	73	10	21158-1282	63	2.094	2.875	0.375	53	73	10
21158-1252	63	2.062	2.875	0.375	52	73	10	21158-1291	63	2.094	3.062	0.375	53	78	10
21527-1252	66	2.062	2.875	0.375	52	73	10	21159-4682	63	2.094	3.189	0.375	53	81	10
24600-1224	26	2.062	2.875	0.468	52	73	12	21158-1306	63	2.094	3.250	0.375	53	83	10
24610-3146	26	2.062	2.875	0.500	52	73	13	21158-1315	63	2.094	3.481	0.375	53	88	10
29502-5705	IG	2.062	2.875	0.750	52	73	19	21158-1318	63	2.094	3.500	0.375	53	89	10
24802-1176	EQUAL	2.062	2.996	0.625	52	76	16	29507-6140	IG	2.112	2.775	0.625	54	70	16
24610-5336	26	2.062	2.997	0.375	52	76	10	29516-7179	IG	2.112	2.776	0.725	54	71	18
25003-1255	23	2.062	2.997	0.390	52	76	10	29500-6053	IG	2.112	3.112	0.750	54	79	19
23548-9621	63R2	2.062	2.997	0.688	52	76	17	26001-5064	71	2.125	2.500	0.250	54	64	6
24620-1258	26R1	2.062	3.000	0.375	52	76	10	24060-2073	61	2.125	2.625	0.375	54	67	10
24600-1258	26	2.062	3.000	0.375	52	76	10	21332-2051	143	2.125	2.725	0.510	54	69	13
24610-1258	26	2.062	3.000	0.375	52	76	10	24060-1467	61	2.125	2.750	0.312	54	70	8
21527-1258	66	2.062	3.000	0.375	52	76	10	24060-4892	61	2.125	2.750	0.375	54	70	10
24600-1260	26	2.062	3.000	0.500	52	76	13	29507-5922	IG	2.125	2.750	0.625	54	70	16
21158-1260	63	2.062	3.000	0.500	52	76	13	26193-7995	76	2.125	2.762	0.250	54	70	6
23078-7145	63F1	2.062	3.000	0.594	52	76	15	24807-3238	EQUAL	2.125	2.763	0.690	54	70	18
29519-1225	IG	2.062	3.000	0.625	52	76	16	24600-1319	26	2.125	2.833	0.438	54	72	11
29602-4119	GD	2.062	3.000	0.700	52	76	18	21159-8112	63	2.125	2.835	0.375	54	72	10
24600-1261	26	2.062	3.062	0.375	52	78	10	21158-8112	63	2.125	2.835	0.375	54	72	10
21168-1261	63	2.062	3.062	0.375	52	78	10	29507-6126	IG	2.125	2.835	0.625	54	72	16
21158-1261	63	2.062	3.062	0.375	52	78	10	24626-1321	26	2.125	2.875	0.375	54	73	10
27223-1261	94	2.062	3.062	0.375	52	78	10	24600-1321	26	2.125	2.875	0.375	54	73	10
21158-1263	63	2.062	3.062	0.500	52	78	13	24610-1321	26	2.125	2.875	0.375	54	73	10
21158-1264	63	2.062	3.125	0.375	52	79	10	24627-1321	26	2.125	2.875	0.375	54	73	10
21695-1264	63	2.062	3.125	0.375	52	79	10	24060-1321	61	2.125	2.875	0.375	54	73	10
24802-2115	EQUAL	2.062	3.125	0.625	52	79	16	21702-1321	62	2.125	2.875	0.375	54	73	10
29502-5634	IG	2.062	3.125	0.750	52	79	19	21158-1321	63	2.125	2.875	0.375	54	73	10
21158-1267	63	2.062	3.147	0.375	52	80	10	21542-1321	63	2.125	2.875	0.375	54	73	10
21158-8350	63	2.062	3.150	0.375	52	80	10	21164-1321	63	2.125	2.875	0.375	54	73	10
21158-1270	63	2.062	3.189	0.375	52	81	10	21695-1321	63	2.125	2.875	0.375	54	73	10
21158-1276	63	2.062	3.250	0.375	52	83	10	21527-1321	66	2.125	2.875	0.375	54	73	10
21158-1279	63	2.062	3.350	0.375	52	85	10	21528-1321	67	2.125	2.875	0.375	54	73	10
29609-6899	GD	2.062	3.625	0.375	52	92	10	21158-1322	63	2.125	2.875	0.437	54	73	11
24802-4057	EQUAL	2.062	3.625	0.625	52	92	16	25010-1320	23	2.125	2.875	0.438	54	73	11
29507-6553	IG	2.063	2.625	0.625	52	67	16	24600-1320	26	2.125	2.875	0.438	54	73	11
21158-3897	63	2.063	2.783	0.375	52	71	10	24610-1320	26	2.125	2.875	0.438	54	73	11
24060-1466	61	2.063	2.875	0.375	52	73	10	24060-1320	61	2.125	2.875	0.438	54	73	11
21158-1253	63	2.063	2.875	0.437	52	73	11	23502-1322	63G1	2.125	2.875	0.438	54	73	11
21158-1255	63	2.063	2.997	0.375	52	76	10	21695-1322	63	2.125	2.875	0.438	54	73	11
21290-1258	63	2.063	3.000	0.375	52	76	10	23501-1323	63G1	2.125	2.875	0.500	54	73	13
21158-1258	63	2.063	3.000	0.375	52	76	10	23502-1323	63G1	2.125	2.875	0.500	54	73	13
21168-1258	63	2.063	3.000	0.375	52	76	10	21158-1323	63	2.125	2.875	0.500	54	73	13
21695-1258	63	2.063	3.000	0.375	52	76	10	21695-1323	63	2.125	2.875	0.500	54	73	13

All dimensions are in inches. Preferred sizes are indicated with **bold** type face.

Sizes listed are for standard nitrile elements, except Models 25 and 62 which have PTFE elements. Other material available on inquiry only.



## Oil Seals by Model Number

Product Code	Model	Inches			MM			Product Code	Model	Inches			MM		
		ID	OD	Width	ID	OD	Width			ID	OD	Width	ID	OD	Width
24802-0709	EQUAL	2.125	2.875	0.500	54	73	13	24600-1334	26	2.125	3.125	0.438	54	79	11
29507-1322	IG	2.125	2.875	0.625	54	73	16	24610-1334	26	2.125	3.125	0.438	54	79	11
29519-1322	IG	2.125	2.875	0.625	54	73	16	25003-1335	23	2.125	3.125	0.500	54	79	13
24801-1322	EQUAL	2.125	2.875	0.625	54	73	16	24610-1335	26	2.125	3.125	0.500	54	79	13
24802-1322	EQUAL	2.125	2.875	0.625	54	73	16	21158-1335	63	2.125	3.125	0.500	54	79	13
24803-1322	EQUAL	2.125	2.875	0.625	54	73	16	24802-1761	EQUAL	2.125	3.125	0.625	54	79	16
24819-1322	EQUAL	2.125	2.875	0.625	54	73	16	24805-1761	EQUAL	2.125	3.125	0.625	54	79	16
23052-4592	63R1	2.125	2.875	0.688	54	73	17	23548-7160	63R2	2.125	3.125	0.688	54	79	17
23547-4592	63R1	2.125	2.875	0.688	54	73	17	29602-4146	GD	2.125	3.125	0.700	54	79	18
23550-4592	63T2	2.125	2.875	0.688	54	73	17	29500-4146	IG	2.125	3.125	0.750	54	79	19
29602-4109	GD	2.125	2.875	0.700	54	73	18	29502-4146	IG	2.125	3.125	0.750	54	79	19
29610-4109	GD	2.125	2.875	0.700	54	73	18	29529-4146	IG	2.125	3.125	0.750	54	79	19
29500-4109	IG	2.125	2.875	0.750	54	73	19	29507-5098	IG	2.125	3.129	0.625	54	79	16
29502-4109	IG	2.125	2.875	0.750	54	73	19	25166-7434	23	2.125	3.136	0.688	54	80	17
29503-4109	IG	2.125	2.875	0.750	54	73	19	21158-1336	63	2.125	3.147	0.375	54	80	10
24620-1321	26R1	2.125	2.878	0.375	54	73	10	21158-8353	63	2.125	3.150	0.375	54	80	10
21158-3900	63	2.125	2.882	0.375	54	73	10	29502-4617	IG	2.125	3.188	0.750	54	81	19
21158-1324	63	2.125	2.997	0.375	54	76	10	21158-1339	63	2.125	3.189	0.375	54	81	10
21158-1326	63	2.125	2.997	0.500	54	76	13	24803-1011	EQUAL	2.125	3.189	0.500	54	81	13
24610-3044	26	2.125	3.000	0.328	54	76	8	24802-1010	EQUAL	2.125	3.189	0.625	54	81	16
21158-1327	63	2.125	3.000	0.375	54	76	10	24600-0817	26	2.125	3.192	0.500	54	81	13
21695-1327	63	2.125	3.000	0.375	54	76	10	24600-1345	26	2.125	3.250	0.375	54	83	10
21527-1327	66	2.125	3.000	0.375	54	76	10	21290-1345	63	2.125	3.250	0.375	54	83	10
24600-1325	26	2.125	3.000	0.500	54	76	13	21158-1345	63	2.125	3.250	0.375	54	83	10
21702-1329	62	2.125	3.000	0.500	54	76	13	24062-1346	61	2.125	3.250	0.438	54	83	11
21158-1329	63	2.125	3.000	0.500	54	76	13	24612-0885	26	2.125	3.250	0.500	54	83	13
29507-1323	IG	2.125	3.000	0.625	54	76	16	24801-1854	EQUAL	2.125	3.250	0.625	54	83	16
24801-1323	EQUAL	2.125	3.000	0.625	54	76	16	24802-1854	EQUAL	2.125	3.250	0.625	54	83	16
24802-1323	EQUAL	2.125	3.000	0.625	54	76	16	24822-1854	EQUAL	2.125	3.250	0.625	54	83	16
24819-1323	EQUAL	2.125	3.000	0.625	54	76	16	29602-4807	GD	2.125	3.250	0.700	54	83	18
24824-1323	EQUAL	2.125	3.000	0.625	54	76	16	29502-4807	IG	2.125	3.250	0.750	54	83	19
23548-6593	63R2	2.125	3.000	0.688	54	76	17	24802-2999	EQUAL	2.125	3.313	0.625	54	84	16
23627-6593	63R2	2.125	3.000	0.688	54	76	17	21158-1348	63	2.125	3.350	0.375	54	85	10
23550-6593	63T2	2.125	3.000	0.688	54	76	17	21695-1350	63	2.125	3.350	0.500	54	85	13
23683-6593	67R2	2.125	3.000	0.688	54	76	17	23548-8404	63R2	2.125	3.350	0.687	54	85	17
29602-4205	GD	2.125	3.000	0.700	54	76	18	21158-1342	63	2.125	3.371	0.469	54	86	12
29502-4205	IG	2.125	3.000	0.750	54	76	19	21158-1351	63	2.125	3.372	0.375	54	86	10
29697-0005	GD	2.125	3.000	0.900	54	76	23	29502-5003	IG	2.125	3.375	0.750	54	86	19
24802-1849	EQUAL	2.125	3.050	0.625	54	77	16	24610-3278	26	2.125	3.500	0.375	54	89	10
29502-6167	IG	2.125	3.060	0.750	54	78	19	21158-1357	63	2.125	3.500	0.375	54	89	10
21158-1330	63	2.125	3.062	0.375	54	78	10	21527-1357	66	2.125	3.500	0.375	54	89	10
21158-1331	63	2.125	3.062	0.437	54	78	11	21158-1359	63	2.125	3.500	0.500	54	89	13
21158-1332	63	2.125	3.062	0.500	54	78	13	29519-3058	IG	2.125	3.500	0.625	54	89	16
23078-5687	63F1	2.125	3.062	0.750	54	78	19	24802-3058	EQUAL	2.125	3.500	0.625	54	89	16
24610-3466	26	2.125	3.100	0.315	54	79	8	29502-5769	IG	2.125	3.500	0.750	54	89	19
24805-2983	EQUAL	2.125	3.100	0.625	54	79	16	29520-5769	IG	2.125	3.500	0.750	54	89	19
24829-2983	EQUAL	2.125	3.100	0.625	54	79	16	24802-1248	EQUAL	2.125	3.520	0.625	54	89	16
24600-1333	26	2.125	3.125	0.375	54	79	10	24620-1355	26R1	2.125	3.545	0.438	54	90	11
24610-1333	26	2.125	3.125	0.375	54	79	10	24600-1355	26	2.125	3.545	0.438	54	90	11
24060-1333	61	2.125	3.125	0.375	54	79	10	29502-1745	IG	2.125	3.625	0.750	54	92	19
21702-1333	62	2.125	3.125	0.375	54	79	10	24802-5368	EQUAL	2.125	3.875	0.625	54	98	16
21158-1333	63	2.125	3.125	0.375	54	79	10	24802-5369	EQUAL	2.125	4.000	0.625	54	102	16
21542-1333	63	2.125	3.125	0.375	54	79	10	24060-3479	61	2.125	4.125	0.500	54	105	13
21695-1333	63	2.125	3.125	0.375	54	79	10	29520-5654	IG	2.134	3.066	0.750	54	78	19
24060-1334	61	2.125	3.125	0.437	54	79	11	24807-3878	EQUAL	2.145	2.865	0.690	54	73	18
21158-1334	63	2.125	3.125	0.437	54	79	11	29507-4839	IG	2.145	2.871	0.625	54	73	16

All dimensions are in inches. Preferred sizes are indicated with **bold** type face.  
 Sizes listed are for standard nitrile elements, except Models 25 and 62 which have PTFE elements. Other material available on inquiry only.

## Oil Seals by Model Number

Product Code	Model	Inches			MM			Product Code	Model	Inches			MM		
		ID	OD	Width	ID	OD	Width			ID	OD	Width	ID	OD	Width
29507-5295	IG	2.147	2.875	0.625	55	73	16	29508-4952	IG	2.165	2.835	0.625	55	72	16
24807-2537	EQUAL	2.147	2.875	0.690	55	73	18	29507-6026	IG	2.165	2.875	0.625	55	73	16
29507-6472	IG	2.148	2.675	0.625	55	68	16	24807-2485	EQUAL	2.165	2.875	0.690	55	73	18
29507-6475	IG	2.148	2.860	0.625	55	73	16	24807-3505	EQUAL	2.165	2.952	0.690	55	75	18
29507-5478	IG	2.148	2.875	0.625	55	73	16	24060-0575	61	2.165	2.953	0.394	55	75	10
29507-4667	IG	2.149	2.875	0.625	55	73	16	29502-4492	IG	2.165	2.953	0.750	55	75	19
29507-6064	IG	2.150	2.850	0.625	55	72	16	24816-7065	EQUAL	2.165	2.972	0.748	55	75	19
24802-3169	EQUAL	2.150	3.150	0.625	55	80	16	29519-1340	IG	2.165	3.000	0.625	55	76	16
29507-5965	IG	2.151	2.875	0.625	55	73	16	24802-1340	EQUAL	2.165	3.000	0.625	55	76	16
24802-3054	EQUAL	2.153	3.153	0.625	55	80	16	24629-1371	26R1	2.165	3.070	0.354	55	78	9
29507-4337	IG	2.155	2.875	0.625	55	73	16	29500-5542	IG	2.165	3.071	0.750	55	78	19
29607-4337	GD	2.155	2.875	0.625	55	73	16	29502-5542	IG	2.165	3.071	0.750	55	78	19
24807-2866	EQUAL	2.155	2.875	0.690	55	73	18	24060-3919	61	2.165	3.145	0.315	55	80	8
29502-4805	IG	2.155	3.155	0.750	55	80	19	25003-3429	23	2.165	3.150	0.394	55	80	10
21158-7667	63	2.156	2.835	0.375	55	72	10	26193-0345	76	2.165	3.150	0.472	55	80	12
24600-5226	26	2.156	2.875	0.375	55	73	10	29507-2005	IG	2.165	3.150	0.625	55	80	16
21159-1360	63	2.156	2.875	0.375	55	73	10	29607-2005	GD	2.165	3.150	0.625	55	80	16
21158-1360	63	2.156	2.875	0.375	55	73	10	29608-2005	GD	2.165	3.150	0.625	55	80	16
21158-9407	63	2.156	2.882	0.375	55	73	10	24802-2005	EQUAL	2.165	3.150	0.625	55	80	16
21158-1363	63	2.156	2.997	0.375	55	76	10	29602-4190	GD	2.165	3.150	0.700	55	80	18
21702-1366	62	2.156	3.000	0.375	55	76	10	29502-4190	IG	2.165	3.150	0.750	55	80	19
21158-1366	63	2.156	3.000	0.375	55	76	10	24801-1884	EQUAL	2.165	3.165	0.625	55	80	16
21695-1375	63	2.156	3.147	0.375	55	80	10	24802-1884	EQUAL	2.165	3.165	0.625	55	80	16
21158-8355	63	2.156	3.150	0.375	55	80	10	29602-5342	GD	2.165	3.165	0.700	55	80	18
24060-1378	61	2.156	3.189	0.375	55	81	10	29502-5342	IG	2.165	3.165	0.750	55	80	19
21158-1378	63	2.156	3.189	0.375	55	81	10	29519-1805	IG	2.165	3.189	0.625	55	81	16
21158-1384	63	2.156	3.250	0.375	55	83	10	24802-1805	EQUAL	2.165	3.189	0.625	55	81	16
21290-8117	63	2.156	3.347	0.375	55	85	10	29502-4786	IG	2.165	3.189	0.750	55	81	19
21158-8117	63	2.156	3.347	0.375	55	85	10	27223-8958	94	2.165	3.250	0.375	55	83	10
21158-1389	63	2.156	3.350	0.500	55	85	13	29502-6419	IG	2.165	3.250	0.750	55	83	19
21158-1390	63	2.156	3.372	0.375	55	86	10	29500-4744	IG	2.165	3.542	0.750	55	90	19
21158-1396	63	2.156	3.500	0.375	55	89	10	24802-1906	EQUAL	2.165	3.543	0.625	55	90	16
21158-1398	63	2.156	3.500	0.500	55	89	13	27223-8006	94	2.165	3.544	0.375	55	90	10
21158-7218	63	2.156	3.544	0.375	55	90	10	24802-5606	EQUAL	2.165	3.744	0.625	55	95	16
21168-7218	63	2.156	3.544	0.375	55	90	10	24600-7209	26	2.165	3.938	0.375	55	100	10
24620-2122	26R1	2.156	4.725	0.375	55	120	10	24626-7209	26	2.165	3.938	0.375	55	100	10
29502-6481	IG	2.156	4.725	0.750	55	120	19	27223-7209	94	2.165	3.938	0.375	55	100	10
24801-4444	EQUAL	2.158	3.150	0.625	55	80	16	29500-6157	IG	2.165	4.724	0.750	55	120	19
29502-4590	IG	2.158	3.158	0.750	55	80	19	24128-3054	61	2.165	2.756	0.472	55	70	12
29502-4403	IG	2.159	3.000	0.750	55	76	19	24629-1369	26R1	2.165	2.835	0.315	55	72	8
24627-3303	26	2.160	2.880	0.375	55	73	10	24620-1369	26R1	2.165	2.835	0.315	55	72	8
29507-3052	IG	2.160	3.160	0.625	55	80	16	24060-0882	61	2.165	2.835	0.315	55	72	8
24802-3052	EQUAL	2.160	3.160	0.625	55	80	16	24064-0882	61	2.165	2.835	0.315	55	72	8
29502-5538	IG	2.160	3.160	0.750	55	80	19	29519-6825	IG	2.165	2.953	0.626	55	75	16
29502-4638	IG	2.160	3.195	0.750	55	81	19	24620-1371	26R1	2.165	3.071	0.354	55	78	9
24801-3223	EQUAL	2.160	3.250	0.625	55	83	16	24629-1370	26R1	2.165	3.071	0.472	55	78	12
29519-6317	IG	2.161	3.125	0.625	55	79	16	24620-1370	26R1	2.165	3.071	0.472	55	78	12
29505-5765	IG	2.161	3.161	0.500	55	80	13	24626-3587	26	2.165	3.150	0.394	55	80	10
29502-5053	IG	2.161	3.161	0.750	55	80	19	24600-3587	26	2.165	3.150	0.394	55	80	10
29619-6861	GD	2.161	3.347	0.625	55	85	16	24622-4260	26R1	2.166	2.835	0.355	55	72	9
29602-6966	GD	2.162	3.162	0.700	55	80	18	24060-1835	61	2.166	2.835	0.394	55	72	10
24060-0574	61	2.165	2.756	0.315	55	70	8	29507-4952	IG	2.166	2.835	0.625	55	72	16
29507-4951	IG	2.165	2.756	0.625	55	70	16	24610-1360	26	2.166	2.844	0.313	55	72	8
24807-2675	EQUAL	2.165	2.756	0.690	55	70	18	29602-4786	GD	2.166	3.189	0.700	55	81	18
29609-1362	GD	2.165	2.835	0.375	55	72	10	24802-4447	EQUAL	2.166	3.938	0.625	55	100	16
24062-3987	61	2.165	2.835	0.437	55	72	11	24802-3015	EQUAL	2.174	3.174	0.625	55	81	16

All dimensions are in inches. Preferred sizes are indicated with **bold** type face.

Sizes listed are for standard nitrile elements, except Models 25 and 62 which have PTFE elements. Other material available on inquiry only.

## Oil Seals by Model Number

Product Code	Model	Inches			MM			Product Code	Model	Inches			MM		
		ID	OD	Width	ID	OD	Width			ID	OD	Width	ID	OD	Width
29508-5254	IG	2.180	2.555	0.625	55	65	16	23549-6699	63TB	2.188	3.147	0.688	56	80	17
29507-5199	IG	2.185	3.189	0.625	55	81	16	21158-8357	63	2.188	3.150	0.375	56	80	10
24801-2489	EQUAL	2.186	3.186	0.625	56	81	16	24627-0642	26	2.188	3.188	0.500	56	81	13
24802-2489	EQUAL	2.186	3.186	0.625	56	81	16	24610-0642	26	2.188	3.188	0.500	56	81	13
23550-4659	63T2	2.187	2.875	0.687	56	73	17	29503-4279	IG	2.188	3.188	0.750	56	81	19
29500-5722	IG	2.187	2.937	0.750	56	75	19	21158-1414	63	2.188	3.189	0.375	56	81	10
21159-3904	63	2.187	2.997	0.375	56	76	10	24802-1353	EQUAL	2.188	3.189	0.625	56	81	16
21158-3904	63	2.187	2.997	0.375	56	76	10	24824-1353	EQUAL	2.188	3.193	0.625	56	81	16
29602-4204	GD	2.187	3.000	0.700	56	76	18	21158-1417	63	2.188	3.246	0.375	56	82	10
29502-4204	IG	2.187	3.000	0.750	56	76	19	21767-1420	62	2.188	3.250	0.375	56	83	10
21158-1410	63	2.187	3.125	0.500	56	79	13	21158-1420	63	2.188	3.250	0.375	56	83	10
29602-4279	GD	2.187	3.187	0.700	56	81	18	21695-1420	63	2.188	3.250	0.375	56	83	10
29502-4279	IG	2.187	3.187	0.750	56	81	19	25003-4126	23	2.188	3.250	0.438	56	83	11
29516-1416	63	2.187	3.189	0.500	56	81	13	24802-2474	EQUAL	2.188	3.250	0.625	56	83	16
21158-1422	63	2.187	3.250	0.500	56	83	13	29502-5307	IG	2.188	3.250	0.750	56	83	19
24801-2474	EQUAL	2.187	3.250	0.625	56	83	16	21158-1423	63	2.188	3.350	0.375	56	85	10
21158-1425	63	2.187	3.350	0.500	56	85	13	21695-1423	63	2.188	3.350	0.375	56	85	10
29516-7093	IG	2.188	2.823	0.943	56	72	24	21695-1424	63	2.188	3.350	0.437	56	85	11
29516-7278	IG	2.188	2.823	0.943	56	72	24	24600-1427	26	2.188	3.350	0.469	56	85	12
29616-7093	GD	2.188	2.823	1.173	56	72	30	29516-7237	IG	2.188	3.366	0.765	56	85	19
24816-7020	EQUAL	2.188	2.825	1.125	56	72	29	21160-1426	63	2.188	3.372	0.375	56	86	10
29507-5012	IG	2.188	2.832	0.625	56	72	16	21158-1426	63	2.188	3.372	0.375	56	86	10
24807-5590	EQUAL	2.188	2.837	0.690	56	72	18	21527-1426	66	2.188	3.372	0.375	56	86	10
24060-1399	61	2.188	2.875	0.375	56	73	10	21158-1428	63	2.188	3.372	0.500	56	86	13
21290-1399	63	2.188	2.875	0.375	56	73	10	24627-3569	26	2.188	3.437	0.375	56	87	10
21158-1399	63	2.188	2.875	0.375	56	73	10	21158-1429	63	2.188	3.481	0.375	56	88	10
21919-1399	63	2.188	2.875	0.375	56	73	10	21158-1432	63	2.188	3.500	0.375	56	89	10
21158-1400	63	2.188	2.875	0.437	56	73	11	21158-1434	63	2.188	3.500	0.500	56	89	13
21158-3903	63	2.188	2.882	0.375	56	73	10	24610-3296	26	2.188	3.688	0.500	56	94	13
24610-2697	26	2.188	2.938	0.375	56	75	10	29616-6945	GD	2.188	3.840	0.959	56	98	24
29516-7105	IG	2.188	2.938	0.882	56	75	22	29500-4485	IG	2.188	5.125	0.750	56	130	19
24627-3599	26	2.188	3.000	0.375	56	76	10	29502-6831	IG	2.189	3.276	0.750	56	83	19
24610-3599	26	2.188	3.000	0.375	56	76	10	29507-5093	IG	2.200	2.750	0.625	56	70	16
21158-1402	63	2.188	3.000	0.375	56	76	10	29507-4953	IG	2.205	2.756	0.625	56	70	16
21168-1402	63	2.188	3.000	0.375	56	76	10	29609-6890	GD	2.205	2.835	0.375	56	72	10
24128-1403	61	2.188	3.000	0.438	56	76	11	24807-4200	EQUAL	2.205	2.837	0.690	56	72	18
25058-1404	25	2.188	3.000	0.500	56	76	13	24802-4201	EQUAL	2.205	3.150	0.625	56	80	16
24600-1404	26	2.188	3.000	0.500	56	76	13	29502-5545	IG	2.205	3.150	0.750	56	80	19
21702-1404	62	2.188	3.000	0.500	56	76	13	29507-6280	IG	2.207	2.834	0.625	56	72	16
21158-1404	63	2.188	3.000	0.500	56	76	13	24060-4298	61	2.212	3.250	0.375	56	83	10
24801-1404	EQUAL	2.188	3.000	0.500	56	76	13	24063-3923	61	2.212	3.250	0.437	56	83	11
29507-1119	IG	2.188	3.000	0.625	56	76	16	21158-1438	63	2.219	3.000	0.375	56	76	10
24802-1119	EQUAL	2.188	3.000	0.625	56	76	16	21805-1438	63	2.219	3.000	0.375	56	76	10
24819-1119	EQUAL	2.188	3.000	0.625	56	76	16	21158-8359	63	2.219	3.150	0.375	56	80	10
21158-1405	63	2.188	3.062	0.375	56	78	10	21158-8360	63	2.219	3.347	0.375	56	85	10
21158-1406	63	2.188	3.062	0.438	56	78	11	21158-1468	63	2.219	3.500	0.375	56	89	10
24807-3249	EQUAL	2.188	3.062	0.690	56	78	18	24802-3056	EQUAL	2.222	3.222	0.625	56	82	16
21527-1405	66	2.188	3.063	0.375	56	78	10	29502-5463	IG	2.225	3.225	0.750	57	82	19
25009-1408	23	2.188	3.125	0.375	56	79	10	29502-4812	IG	2.228	3.228	0.750	57	82	19
24600-1408	26	2.188	3.125	0.375	56	79	10	24802-3153	EQUAL	2.230	3.230	0.625	57	82	16
21702-1408	62	2.188	3.125	0.375	56	79	10	21158-7702	63	2.232	3.543	0.375	57	90	10
21158-1408	63	2.188	3.125	0.375	56	79	10	29502-6039	IG	2.240	2.994	0.750	57	76	19
21900-1408	66	2.188	3.125	0.375	56	79	10	29502-5056	IG	2.240	3.240	0.750	57	82	19
24610-5612	26	2.188	3.125	0.438	56	79	11	29502-6262	IG	2.244	3.043	0.750	57	77	19
21158-1411	63	2.188	3.147	0.375	56	80	10	29507-6519	IG	2.244	3.228	0.625	57	82	16
21158-1413	63	2.188	3.147	0.500	56	80	13	24802-1981	EQUAL	2.244	3.268	0.625	57	83	16

All dimensions are in inches. Preferred sizes are indicated with **bold** type face. Sizes listed are for standard nitrile elements, except Models 25 and 62 which have PTFE elements. Other material available on inquiry only.

## Oil Seals by Model Number

Product Code	Model	Inches			MM			Product Code	Model	Inches			MM		
		ID	OD	Width	ID	OD	Width			ID	OD	Width	ID	OD	Width
29502-6751	IG	2.244	3.425	0.750	57	87	19	23624-6478	63R2	2.250	3.000	0.688	57	76	17
29502-5211	IG	2.248	3.150	0.750	57	80	19	23548-6478	63R2	2.250	3.000	0.688	57	76	17
24802-5936	EQUAL	2.248	3.228	0.625	57	82	16	23627-6478	63R2	2.250	3.000	0.688	57	76	17
26001-6284	71	2.250	2.625	0.109	57	67	3	23550-6478	63T2	2.250	3.000	0.688	57	76	17
29507-6113	IG	2.250	2.625	0.625	57	67	16	24807-3298	EQUAL	2.250	3.000	0.690	57	76	18
24807-2567	EQUAL	2.250	2.625	0.690	57	67	18	24838-3298	EQUAL	2.250	3.000	0.690	57	76	18
24807-1802	EQUAL	2.250	2.750	0.690	57	70	18	29602-4462	GD	2.250	3.000	0.700	57	76	18
29507-6297	IG	2.250	2.800	0.625	57	71	16	29500-4462	IG	2.250	3.000	0.750	57	76	19
24060-1503	61	2.250	2.875	0.312	57	73	8	29502-4462	IG	2.250	3.000	0.750	57	76	19
24600-1469	26	2.250	2.875	0.313	57	73	8	21158-1477	63	2.250	3.062	0.375	57	78	10
24602-1469	26	2.250	2.875	0.313	57	73	8	21695-1477	63	2.250	3.062	0.375	57	78	10
24060-1507	61	2.250	2.875	0.375	57	73	10	25010-1480	23	2.250	3.125	0.375	57	79	10
24060-2797	61	2.250	2.875	0.438	57	73	11	25138-1480	23	2.250	3.125	0.375	57	79	10
24063-2797	61	2.250	2.875	0.438	57	73	11	25003-1480	23	2.250	3.125	0.375	57	79	10
29507-5564	IG	2.250	2.875	0.625	57	73	16	21159-1480	63	2.250	3.125	0.375	57	79	10
24807-2667	EQUAL	2.250	2.875	0.690	57	73	18	21158-1480	63	2.250	3.125	0.375	57	79	10
29516-7076	IG	2.250	2.938	0.864	57	75	22	21695-1480	63	2.250	3.125	0.375	57	79	10
24801-1473	EQUAL	2.250	2.995	0.625	57	76	16	25003-1482	23	2.250	3.125	0.500	57	79	13
21702-1471	62	2.250	2.997	0.375	57	76	10	24600-1482	26	2.250	3.125	0.500	57	79	13
21290-1471	63	2.250	2.997	0.375	57	76	10	21158-1482	63	2.250	3.125	0.500	57	79	13
21159-1471	63	2.250	2.997	0.375	57	76	10	24801-1482	EQUAL	2.250	3.125	0.500	57	79	13
21158-1471	63	2.250	2.997	0.375	57	76	10	24801-1483	EQUAL	2.250	3.125	0.625	57	79	16
21695-1471	63	2.250	2.997	0.375	57	76	10	24802-1483	EQUAL	2.250	3.125	0.625	57	79	16
21823-1471	68	2.250	2.997	0.375	57	76	10	29502-5419	IG	2.250	3.125	0.750	57	79	19
21767-1472	62	2.250	2.997	0.437	57	76	11	21158-1483	63	2.250	3.147	0.375	57	80	10
21158-1473	63	2.250	2.997	0.500	57	76	13	21158-1485	63	2.250	3.147	0.500	57	80	13
23078-5208	63F1	2.250	2.997	0.594	57	76	15	23078-7142	63F1	2.250	3.147	0.594	57	80	15
23548-6795	63R2	2.250	2.997	0.688	57	76	17	23547-4905	63R1	2.250	3.147	0.687	57	80	17
23078-8498	63F1	2.250	2.997	0.750	57	76	19	21158-8361	63	2.250	3.150	0.375	57	80	10
29502-4408	IG	2.250	2.997	0.750	57	76	19	24802-1180	EQUAL	2.250	3.188	0.625	57	81	16
24627-1474	26	2.250	3.000	0.375	57	76	10	24819-1180	EQUAL	2.250	3.188	0.625	57	81	16
24600-1474	26	2.250	3.000	0.375	57	76	10	21159-1486	63	2.250	3.189	0.375	57	81	10
24610-1474	26	2.250	3.000	0.375	57	76	10	21158-1486	63	2.250	3.189	0.375	57	81	10
24612-1474	26	2.250	3.000	0.375	57	76	10	21163-1486	63	2.250	3.189	0.375	57	81	10
24060-1474	61	2.250	3.000	0.375	57	76	10	29507-1901	IG	2.250	3.189	0.625	57	81	16
21767-1474	62	2.250	3.000	0.375	57	76	10	24801-1901	EQUAL	2.250	3.189	0.625	57	81	16
21159-1474	63	2.250	3.000	0.375	57	76	10	24802-1901	EQUAL	2.250	3.189	0.625	57	81	16
21158-1474	63	2.250	3.000	0.375	57	76	10	24803-1901	EQUAL	2.250	3.189	0.625	57	81	16
21163-1474	63	2.250	3.000	0.375	57	76	10	24819-1901	EQUAL	2.250	3.189	0.625	57	81	16
21168-1474	63	2.250	3.000	0.375	57	76	10	24807-3778	EQUAL	2.250	3.190	0.690	57	81	18
21795-1474	63	2.250	3.000	0.375	57	76	10	29602-4367	GD	2.250	3.190	0.700	57	81	18
21695-1474	63	2.250	3.000	0.375	57	76	10	29502-4367	IG	2.250	3.190	0.750	57	81	19
21920-1474	66	2.250	3.000	0.375	57	76	10	21158-1489	63	2.250	3.246	0.375	57	82	10
21527-1474	66	2.250	3.000	0.375	57	76	10	21158-1491	63	2.250	3.246	0.500	57	82	13
29609-1474	GD	2.250	3.000	0.375	57	76	10	23547-7691	63R1	2.250	3.246	0.688	57	82	17
24067-1475	61	2.250	3.000	0.437	57	76	11	25003-1492	23	2.250	3.250	0.375	57	83	10
24060-1475	61	2.250	3.000	0.437	57	76	11	24600-1492	26	2.250	3.250	0.375	57	83	10
21158-1475	63	2.250	3.000	0.438	57	76	11	24610-1492	26	2.250	3.250	0.375	57	83	10
21919-1475	63	2.250	3.000	0.438	57	76	11	21702-1492	62	2.250	3.250	0.375	57	83	10
24062-1476	61	2.250	3.000	0.500	57	76	13	21290-1492	63	2.250	3.250	0.375	57	83	10
21158-1476	63	2.250	3.000	0.500	57	76	13	21158-1492	63	2.250	3.250	0.375	57	83	10
24801-1476	EQUAL	2.250	3.000	0.500	57	76	13	21168-1492	63	2.250	3.250	0.375	57	83	10
29519-1479	IG	2.250	3.000	0.625	57	76	16	21695-1492	63	2.250	3.250	0.375	57	83	10
24801-1479	EQUAL	2.250	3.000	0.625	57	76	16	24610-0807	26	2.250	3.250	0.437	57	83	11
24802-1479	EQUAL	2.250	3.000	0.625	57	76	16	24060-1493	61	2.250	3.250	0.437	57	83	11
24813-1479	EQUAL	2.250	3.000	0.625	57	76	16	21158-1493	63	2.250	3.250	0.437	57	83	11

All dimensions are in inches. Preferred sizes are indicated with **bold** type face.

Sizes listed are for standard nitrile elements, except Models 25 and 62 which have PTFE elements. Other material available on inquiry only.

## Oil Seals by Model Number

Product Code	Model	Inches			MM			Product Code	Model	Inches			MM		
		ID	OD	Width	ID	OD	Width			ID	OD	Width	ID	OD	Width
21695-1493	63	2.250	3.250	0.437	57	83	11	29519-5860	IG	2.250	3.500	0.438	57	89	11
25010-1493	23	2.250	3.250	0.438	57	83	11	21702-1504	62	2.250	3.500	0.500	57	89	13
25003-1493	23	2.250	3.250	0.438	57	83	11	23501-1506	63G1	2.250	3.500	0.500	57	89	13
25004-1493	23	2.250	3.250	0.438	57	83	11	21158-1506	63	2.250	3.500	0.500	57	89	13
24062-1493	61	2.250	3.250	0.438	57	83	11	23078-4735	63F1	2.250	3.500	0.594	57	89	15
25003-1494	23	2.250	3.250	0.500	57	83	13	29519-1755	IG	2.250	3.500	0.625	57	89	16
25058-1494	25	2.250	3.250	0.500	57	83	13	24802-1755	EQUAL	2.250	3.500	0.625	57	89	16
24627-1494	26	2.250	3.250	0.500	57	83	13	23547-6757	63R1	2.250	3.500	0.688	57	89	17
24610-1494	26	2.250	3.250	0.500	57	83	13	23550-6757	63T2	2.250	3.500	0.688	57	89	17
24064-1494	61	2.250	3.250	0.500	57	83	13	29502-5820	IG	2.250	3.500	0.750	57	89	19
24062-1494	61	2.250	3.250	0.500	57	83	13	29518-6057	IG	2.250	3.500	0.875	57	89	22
21290-1494	63	2.250	3.250	0.500	57	83	13	29612-3366	GD	2.250	3.625	0.625	57	92	16
21158-1494	63	2.250	3.250	0.500	57	83	13	24801-3366	EQUAL	2.250	3.625	0.625	57	92	16
21168-1494	63	2.250	3.250	0.500	57	83	13	24802-3366	EQUAL	2.250	3.625	0.625	57	92	16
21795-1494	63	2.250	3.250	0.500	57	83	13	29500-4874	IG	2.250	3.625	0.750	57	92	19
24801-1494	EQUAL	2.250	3.250	0.500	57	83	13	29502-4874	IG	2.250	3.625	0.750	57	92	19
24802-1494	EQUAL	2.250	3.250	0.500	57	83	13	24600-1511	26	2.250	3.750	0.500	57	95	13
24802-1493	EQUAL	2.250	3.250	0.625	57	83	16	24801-5944	EQUAL	2.250	3.750	0.625	57	95	16
24803-1493	EQUAL	2.250	3.250	0.625	57	83	16	24620-5426	26R1	2.250	3.876	0.468	57	98	12
24824-1493	EQUAL	2.250	3.250	0.625	57	83	16	29516-7166	IG	2.250	3.976	0.765	57	101	19
23550-4665	63T2	2.250	3.250	0.687	57	83	17	24060-3414	61	2.250	4.003	0.468	57	102	12
23548-4665	63R2	2.250	3.250	0.688	57	83	17	24626-3547	26	2.250	4.751	0.750	57	121	19
29602-4148	GD	2.250	3.250	0.700	57	83	18	29602-5134	GD	2.250	4.812	0.700	57	122	18
29500-4148	IG	2.250	3.250	0.750	57	83	19	29502-4813	IG	2.258	3.258	0.750	57	83	19
29502-4148	IG	2.250	3.250	0.750	57	83	19	29502-6981	IG	2.263	3.263	0.750	57	83	19
29529-4148	IG	2.250	3.250	0.750	57	83	19	24802-2897	EQUAL	2.264	3.250	0.625	58	83	16
24801-1493	EQUAL	2.250	3.251	0.625	57	83	16	29502-5734	IG	2.275	3.275	0.750	58	83	19
24801-5732	EQUAL	2.250	3.312	0.625	57	84	16	24802-2312	EQUAL	2.280	3.280	0.625	58	83	16
24627-3485	26	2.250	3.313	0.500	57	84	13	29602-4338	GD	2.280	3.280	0.700	58	83	18
24610-3485	26	2.250	3.313	0.500	57	84	13	29502-4338	IG	2.280	3.280	0.750	58	83	19
21158-8362	63	2.250	3.347	0.375	57	85	10	29503-4338	IG	2.280	3.280	0.750	58	83	19
21168-8362	63	2.250	3.347	0.375	57	85	10	21158-1513	63	2.281	3.062	0.375	58	78	10
21159-1495	63	2.250	3.350	0.375	57	85	10	24610-3202	26	2.281	3.062	0.500	58	78	13
21160-1495	63	2.250	3.350	0.375	57	85	10	21158-8904	63	2.281	3.154	0.375	58	80	10
21158-1495	63	2.250	3.350	0.375	57	85	10	21158-1543	63	2.281	3.543	0.375	58	90	10
21163-1495	63	2.250	3.350	0.375	57	85	10	29507-6089	IG	2.283	2.658	0.625	58	68	16
21159-1496	63	2.250	3.350	0.437	57	85	11	24807-3657	EQUAL	2.283	2.835	0.690	58	72	18
21158-5560	63	2.250	3.350	0.469	57	85	12	24801-1985	EQUAL	2.283	3.150	0.500	58	80	13
21159-1497	63	2.250	3.350	0.500	57	85	13	29502-6021	IG	2.283	3.150	0.750	58	80	19
24802-1498	EQUAL	2.250	3.350	0.625	57	85	16	29520-6510	IG	2.283	3.307	0.750	58	84	19
24600-1508	26	2.250	3.353	0.375	57	85	10	29502-6228	IG	2.283	4.331	0.750	58	110	19
29516-7188	IG	2.250	3.366	0.765	57	85	19	29502-5931	IG	2.283	4.409	0.750	58	112	19
21158-1498	63	2.250	3.372	0.375	57	86	10	24802-3025	EQUAL	2.283	3.543	0.625	58	90	16
21158-1499	63	2.250	3.372	0.438	57	86	11	29619-6882	GD	2.296	3.543	0.625	58	90	16
21158-1500	63	2.250	3.372	0.500	57	86	13	29602-6881	GD	2.296	3.543	0.700	58	90	18
23549-9844	63TB	2.250	3.372	0.688	57	86	17	29502-5825	IG	2.300	3.300	0.750	58	84	19
24060-1509	61	2.250	3.375	0.437	57	86	11	24802-3577	EQUAL	2.307	4.331	0.625	59	110	16
24600-1509	26	2.250	3.375	0.500	57	86	13	24627-3261	26	2.310	3.063	0.313	59	78	8
24801-1245	EQUAL	2.250	3.375	0.625	57	86	16	29507-5017	IG	2.312	3.000	0.625	59	76	16
24802-1245	EQUAL	2.250	3.375	0.625	57	86	16	24610-3300	26	2.312	3.062	0.375	59	78	10
24600-1504	26	2.250	3.500	0.375	57	89	10	24610-2678	26	2.312	3.125	0.437	59	79	11
21158-1504	63	2.250	3.500	0.375	57	89	10	24610-1563	26	2.312	3.125	0.500	59	79	13
21163-1504	63	2.250	3.500	0.375	57	89	10	24062-1563	61	2.312	3.125	0.500	59	79	13
21527-1504	66	2.250	3.500	0.375	57	89	10	24629-1575	26R1	2.312	3.250	0.500	59	83	13
21290-1505	63	2.250	3.500	0.437	57	89	11	21158-1575	63	2.312	3.250	0.500	59	83	13
21158-1505	63	2.250	3.500	0.438	57	89	11	24062-4958	61	2.312	3.250	0.687	59	83	17

All dimensions are in inches. Preferred sizes are indicated with **bold** type face. Sizes listed are for standard nitrile elements, except Models 25 and 62 which have PTFE elements. Other material available on inquiry only.

## Oil Seals by Model Number

Product Code	Model	Inches			MM			Product Code	Model	Inches			MM		
		ID	OD	Width	ID	OD	Width			ID	OD	Width	ID	OD	Width
29602-4257	GD	2.312	3.312	0.700	59	84	18	29602-6617	GD	2.315	3.346	0.700	59	85	18
21158-1578	63	2.312	3.350	0.500	59	85	13	29502-6617	IG	2.315	3.346	0.750	59	85	19
29502-5666	IG	2.312	3.375	0.750	59	86	19	29502-5059	IG	2.317	3.375	0.750	59	86	19
21158-1582	63	2.312	3.481	0.375	59	88	10	29500-1257	IG	2.318	3.125	0.750	59	79	19
29502-5653	IG	2.312	3.500	0.750	59	89	19	24801-1557	EQUAL	2.327	3.250	0.500	59	83	13
29502-6691	IG	2.312	3.557	0.750	59	90	19	29502-5801	IG	2.335	3.335	0.750	59	85	19
29519-6708	IG	2.312	3.562	0.625	59	90	16	29502-5729	IG	2.341	3.151	0.750	59	80	19
29518-5709	IG	2.312	3.562	0.875	59	90	22	29507-7526	IG	2.343	3.343	0.625	60	85	16
29502-5818	IG	2.312	3.750	0.750	59	95	19	21158-1597	63	2.344	3.062	0.375	60	78	10
29500-4861	IG	2.312	3.812	0.750	59	97	19	21158-1600	63	2.344	3.125	0.375	60	79	10
21158-1552	63	2.313	2.997	0.375	59	76	10	24600-1602	26	2.344	3.125	0.500	60	79	13
21290-1555	63	2.313	3.000	0.375	59	76	10	21158-1602	63	2.344	3.125	0.500	60	79	13
21159-1555	63	2.313	3.000	0.375	59	76	10	21158-1603	63	2.344	3.147	0.375	60	80	10
21158-1555	63	2.313	3.000	0.375	59	76	10	25054-8276	23	2.344	3.219	0.625	60	82	16
21795-1555	63	2.313	3.000	0.375	59	76	10	25003-8276	23	2.344	3.219	0.625	60	82	16
21177-1555	63	2.313	3.000	0.375	59	76	10	25004-8276	23	2.344	3.219	0.625	60	82	16
24128-2815	61	2.313	3.000	0.438	59	76	11	21158-1612	63	2.344	3.250	0.375	60	83	10
24627-3300	26	2.313	3.062	0.375	59	78	10	29502-6002	IG	2.344	3.250	0.750	60	83	19
24600-3300	26	2.313	3.062	0.375	59	78	10	21158-1615	63	2.344	3.350	0.375	60	85	10
21158-1558	63	2.313	3.062	0.375	59	78	10	21158-1618	63	2.344	3.372	0.375	60	86	10
24801-3239	EQUAL	2.313	3.062	0.625	59	78	16	21158-1620	63	2.344	3.372	0.500	60	86	13
24824-3239	EQUAL	2.313	3.062	0.625	59	78	16	21158-1621	63	2.344	3.481	0.375	60	88	10
24807-3237	EQUAL	2.313	3.062	0.690	59	78	18	24060-1624	61	2.344	3.500	0.375	60	89	10
24600-1561	26	2.313	3.125	0.375	59	79	10	21158-1624	63	2.344	3.500	0.375	60	89	10
21158-1561	63	2.313	3.125	0.375	59	79	10	21158-1626	63	2.344	3.500	0.500	60	89	13
24807-3645	EQUAL	2.313	3.188	0.690	59	81	18	21158-1630	63	2.344	3.623	0.375	60	92	10
21158-1567	63	2.313	3.189	0.375	59	81	10	21163-1630	63	2.344	3.623	0.375	60	92	10
25003-3427	23	2.313	3.194	0.500	59	81	13	21158-1633	63	2.344	3.751	0.375	60	95	10
21158-4571	63	2.313	3.246	0.500	59	82	13	21158-1636	63	2.344	3.875	0.375	60	98	10
21158-1573	63	2.313	3.250	0.375	59	83	10	21158-1638	63	2.344	3.875	0.500	60	98	13
21168-1573	63	2.313	3.250	0.375	59	83	10	24610-3340	26	2.345	3.095	0.375	60	79	10
21695-1573	63	2.313	3.250	0.375	59	83	10	29502-5978	IG	2.345	3.345	0.750	60	85	19
25003-4115	23	2.313	3.250	0.438	59	83	11	29502-5443	IG	2.345	3.375	0.750	60	86	19
24620-1575	26R1	2.313	3.250	0.500	59	83	13	29602-6812	GD	2.348	3.348	0.700	60	85	18
24801-1552	EQUAL	2.313	3.250	0.500	59	83	13	24802-2618	EQUAL	2.350	3.350	0.625	60	85	16
29607-1766	GD	2.313	3.250	0.625	59	83	16	29502-4609	IG	2.350	3.350	0.750	60	85	19
24802-1766	EQUAL	2.313	3.250	0.625	59	83	16	29502-4687	IG	2.350	3.375	0.750	60	86	19
23548-4958	63R2	2.313	3.250	0.688	59	83	17	29602-6809	GD	2.352	3.352	0.700	60	85	18
23550-4958	63T2	2.313	3.250	0.688	59	83	17	29502-4601	IG	2.352	3.375	0.750	60	86	19
29502-4478	IG	2.313	3.250	0.750	59	83	19	24610-3412	26	2.353	3.228	0.375	60	82	10
24610-1553	26	2.313	3.251	0.438	59	83	11	25003-3082	23	2.353	3.228	0.474	60	82	12
24801-1351	EQUAL	2.313	3.313	0.625	59	84	16	29502-5076	IG	2.354	3.354	0.750	60	85	19
24802-1351	EQUAL	2.313	3.313	0.625	59	84	16	24822-2679	EQUAL	2.355	3.355	0.625	60	85	16
29502-4257	IG	2.313	3.313	0.750	59	84	19	29602-4351	GD	2.355	3.870	0.700	60	98	18
24801-1136	EQUAL	2.313	3.355	0.625	59	85	16	29502-4351	IG	2.355	3.870	0.750	60	98	19
24802-3480	EQUAL	2.313	3.371	0.625	59	86	16	29602-6650	GD	2.356	3.356	0.700	60	85	18
21158-1579	63	2.313	3.372	0.375	59	86	10	24802-1943	EQUAL	2.356	3.625	0.625	60	92	16
24802-3582	EQUAL	2.313	3.438	0.625	59	87	16	29502-5473	IG	2.356	3.780	0.750	60	96	19
21158-1585	63	2.313	3.500	0.375	59	89	10	24822-2951	EQUAL	2.357	3.357	0.625	60	85	16
21158-1587	63	2.313	3.500	0.500	59	89	13	29602-6595	GD	2.358	3.465	0.700	60	88	18
24802-2632	EQUAL	2.313	3.500	0.625	59	89	16	24807-2874	EQUAL	2.359	2.734	0.690	60	69	18
24802-4392	EQUAL	2.313	3.625	0.625	59	92	16	29502-6275	IG	2.360	3.149	0.750	60	80	19
24801-3267	EQUAL	2.313	3.750	0.625	59	95	16	24060-0653	61	2.360	3.150	0.315	60	80	8
21158-1594	63	2.313	3.751	0.375	59	95	10	29602-4883	GD	2.360	3.360	0.700	60	85	18
21695-1594	63	2.313	3.751	0.375	59	95	10	29502-4883	IG	2.360	3.360	0.750	60	85	19
21158-1596	63	2.313	3.751	0.500	59	95	13	29502-4693	IG	2.360	3.375	0.750	60	86	19

All dimensions are in inches. Preferred sizes are indicated with **bold** type face.

Sizes listed are for standard nitrile elements, except Models 25 and 62 which have PTFE elements. Other material available on inquiry only.

## Oil Seals by Model Number

Product Code	Model	Inches			MM			Product Code	Model	Inches			MM		
		ID	OD	Width	ID	OD	Width			ID	OD	Width	ID	OD	Width
29609-6952	GD	2.360	3.740	0.375	60	95	10	23548-5980	63R2	2.373	3.350	0.688	60	85	17
29619-6866	GD	2.360	3.740	0.625	60	95	16	29507-5063	IG	2.375	2.938	0.625	60	75	16
24802-3540	EQUAL	2.360	4.090	0.625	60	104	16	24060-1514	61	2.375	3.000	0.312	60	76	8
24629-1605	26R1	2.362	2.953	0.315	60	75	8	24060-1523	61	2.375	3.000	0.438	60	76	11
21003-1490	58	2.362	2.953	0.315	60	75	8	29507-5265	IG	2.375	3.000	0.625	60	76	16
24060-1490	61	2.362	2.953	0.315	60	75	8	24807-6134	EQUAL	2.375	3.000	0.690	60	76	18
29502-5535	IG	2.362	3.111	0.750	60	79	19	21702-1639	62	2.375	3.062	0.375	60	78	10
25003-8905	23	2.362	3.112	0.375	60	79	10	21159-1639	63	2.375	3.062	0.375	60	78	10
24610-1566	26	2.362	3.149	0.393	60	80	10	21160-1639	63	2.375	3.062	0.375	60	78	10
24626-1566	26	2.362	3.149	0.394	60	80	10	21158-1639	63	2.375	3.062	0.375	60	78	10
24627-1566	26	2.362	3.150	0.394	60	80	10	21168-1639	63	2.375	3.062	0.375	60	78	10
24626-5115	26	2.362	3.150	0.394	60	80	10	24600-1639	26	2.375	3.062	0.500	60	78	13
24060-1839	61	2.362	3.150	0.394	60	80	10	21158-1641	63	2.375	3.062	0.500	60	78	13
24064-1839	61	2.362	3.150	0.394	60	80	10	23769-5968	63R2	2.375	3.062	0.688	60	78	17
29507-1348	IG	2.362	3.150	0.625	60	80	16	23548-5968	63R2	2.375	3.062	0.688	60	78	17
29519-1348	IG	2.362	3.150	0.625	60	80	16	24807-3198	EQUAL	2.375	3.062	0.690	60	78	18
24801-5431	EQUAL	2.362	3.150	0.625	60	80	16	29507-4547	IG	2.375	3.063	0.625	60	78	16
24802-1348	EQUAL	2.362	3.150	0.625	60	80	16	25284-1642	23	2.375	3.125	0.375	60	79	10
24807-3639	EQUAL	2.362	3.150	0.690	60	80	18	25009-1642	23	2.375	3.125	0.375	60	79	10
29502-5543	IG	2.362	3.150	0.750	60	80	19	25003-1642	23	2.375	3.125	0.375	60	79	10
25003-4387	23	2.362	3.228	0.472	60	82	12	25004-1642	23	2.375	3.125	0.375	60	79	10
24629-1606	26R1	2.362	3.228	0.472	60	82	12	25009-1652	23	2.375	3.125	0.375	60	79	10
24801-1876	EQUAL	2.362	3.228	0.625	60	82	16	24629-1642	26R1	2.375	3.125	0.375	60	79	10
24802-1876	EQUAL	2.362	3.228	0.625	60	82	16	24620-1642	26R1	2.375	3.125	0.375	60	79	10
29507-5126	IG	2.362	3.308	0.625	60	84	16	24626-1642	26	2.375	3.125	0.375	60	79	10
29519-5126	IG	2.362	3.308	0.625	60	84	16	24627-1642	26	2.375	3.125	0.375	60	79	10
24802-3309	EQUAL	2.362	3.346	0.625	60	85	16	24600-1642	26	2.375	3.125	0.375	60	79	10
24818-2651	EQUAL	2.362	3.346	0.630	60	85	16	24610-1642	26	2.375	3.125	0.375	60	79	10
29602-4191	GD	2.362	3.346	0.700	60	85	18	24060-1642	61	2.375	3.125	0.375	60	79	10
29502-4191	IG	2.362	3.346	0.750	60	85	19	21702-1642	62	2.375	3.125	0.375	60	79	10
29510-4191	IG	2.362	3.346	0.750	60	85	19	21159-1642	63	2.375	3.125	0.375	60	79	10
29519-1806	IG	2.362	3.362	0.625	60	85	16	21475-1642	63	2.375	3.125	0.375	60	79	10
24802-1806	EQUAL	2.362	3.362	0.625	60	85	16	21158-1642	63	2.375	3.125	0.375	60	79	10
29602-5512	GD	2.362	3.362	0.700	60	85	18	21527-1642	66	2.375	3.125	0.375	60	79	10
29500-5512	IG	2.362	3.362	0.750	60	85	19	21518-1642	66	2.375	3.125	0.375	60	79	10
24816-7058	EQUAL	2.362	3.366	0.750	60	85	19	21702-1644	62	2.375	3.125	0.500	60	79	13
29516-7136	IG	2.362	3.366	0.788	60	85	20	21158-1644	63	2.375	3.125	0.500	60	79	13
24801-1870	EQUAL	2.362	3.543	0.500	60	90	13	23078-6459	63F1	2.375	3.125	0.594	60	79	15
24801-2488	EQUAL	2.362	3.543	0.625	60	90	16	29507-1645	IG	2.375	3.125	0.625	60	79	16
29602-6546	GD	2.362	3.543	0.700	60	90	18	24802-1645	EQUAL	2.375	3.125	0.625	60	79	16
24060-2584	61	2.362	4.331	0.438	60	110	11	24807-2831	EQUAL	2.375	3.125	0.690	60	79	18
21003-2488	58	2.362	4.331	0.512	60	110	13	29602-4324	GD	2.375	3.125	0.700	60	79	18
29502-6485	IG	2.362	4.409	0.750	60	112	19	29502-4324	IG	2.375	3.125	0.750	60	79	19
24622-4258	26R1	2.362	3.071	0.354	60	78	9	29521-5799	IG	2.375	3.125	0.875	60	79	22
24622-1604	26R1	2.362	3.150	0.276	60	80	7	24801-0716	EQUAL	2.375	3.126	0.500	60	79	13
24600-5115	26	2.362	3.150	0.394	60	80	10	29602-5585	GD	2.375	3.130	0.700	60	80	18
24620-1606	26R1	2.362	3.228	0.472	60	82	12	29502-5585	IG	2.375	3.130	0.750	60	80	19
24629-1031	26R1	2.362	3.543	0.551	60	90	14	21158-1645	63	2.375	3.147	0.375	60	80	10
24620-1031	26R1	2.362	3.543	0.551	60	90	14	21158-1647	63	2.375	3.147	0.500	60	80	13
29519-2488	IG	2.362	3.543	0.626	60	90	16	21527-8369	66	2.375	3.150	0.375	60	80	10
24620-1605	26R1	2.363	2.953	0.315	60	75	8	24600-1572	26	2.375	3.188	0.438	60	81	11
24600-1568	26	2.363	3.127	0.375	60	79	10	21158-1648	63	2.375	3.189	0.375	60	81	10
29502-6231	IG	2.363	3.150	0.750	60	80	19	21527-1648	66	2.375	3.189	0.375	60	81	10
29602-6588	GD	2.365	3.125	0.700	60	79	18	21158-1651	63	2.375	3.246	0.375	60	82	10
29502-6748	IG	2.365	3.375	0.750	60	86	19	23078-4746	63F1	2.375	3.246	0.594	60	82	15
29602-6791	GD	2.372	3.372	0.700	60	86	18	24626-1580	26	2.375	3.250	0.328	60	83	8

All dimensions are in inches. Preferred sizes are indicated with **bold** type face.  
 Sizes listed are for standard nitrile elements, except Models 25 and 62 which have PTFE elements. Other material available on inquiry only.

## Oil Seals by Model Number

Product Code	Model	Inches			MM			Product Code	Model	Inches			MM		
		ID	OD	Width	ID	OD	Width			ID	OD	Width	ID	OD	Width
24600-1580	26	2.375	3.250	0.328	60	83	8	21702-1666	62	2.375	3.500	0.375	60	89	10
21702-1654	62	2.375	3.250	0.375	60	83	10	21158-1666	63	2.375	3.500	0.375	60	89	10
21158-1654	63	2.375	3.250	0.375	60	83	10	21695-1666	63	2.375	3.500	0.375	60	89	10
21695-1654	63	2.375	3.250	0.375	60	83	10	29609-0838	GD	2.375	3.500	0.375	60	89	10
21518-1654	66	2.375	3.250	0.375	60	83	10	25004-1668	23	2.375	3.500	0.500	60	89	13
21527-1654	66	2.375	3.250	0.375	60	83	10	24600-1668	26	2.375	3.500	0.500	60	89	13
24060-1655	61	2.375	3.250	0.437	60	83	11	24602-1668	26	2.375	3.500	0.500	60	89	13
21702-1656	62	2.375	3.250	0.500	60	83	13	24612-1668	26	2.375	3.500	0.500	60	89	13
21158-1656	63	2.375	3.250	0.500	60	83	13	21702-1668	62	2.375	3.500	0.500	60	89	13
21168-1656	63	2.375	3.250	0.500	60	83	13	21159-1668	63	2.375	3.500	0.500	60	89	13
21527-1656	66	2.375	3.250	0.500	60	83	13	21475-1668	63	2.375	3.500	0.500	60	89	13
24801-0738	EQUAL	2.375	3.250	0.500	60	83	13	21158-1668	63	2.375	3.500	0.500	60	89	13
29507-1581	IG	2.375	3.250	0.625	60	83	16	24803-1668	EQUAL	2.375	3.500	0.500	60	89	13
29607-1581	GD	2.375	3.250	0.625	60	83	16	24801-1211	EQUAL	2.375	3.500	0.625	60	89	16
29619-1581	GD	2.375	3.250	0.625	60	83	16	24802-1211	EQUAL	2.375	3.500	0.625	60	89	16
24801-1581	EQUAL	2.375	3.250	0.625	60	83	16	23547-4914	63R1	2.375	3.500	0.687	60	89	17
24802-1581	EQUAL	2.375	3.250	0.625	60	83	16	29602-4806	GD	2.375	3.500	0.700	60	89	18
24819-1581	EQUAL	2.375	3.250	0.625	60	83	16	29500-4806	IG	2.375	3.500	0.750	60	89	19
24822-1581	EQUAL	2.375	3.250	0.625	60	83	16	29502-4806	IG	2.375	3.500	0.750	60	89	19
29602-4112	GD	2.375	3.250	0.700	60	83	18	21158-1669	63	2.375	3.543	0.375	60	90	10
29500-4112	IG	2.375	3.250	0.750	60	83	19	21482-1669	66	2.375	3.543	0.375	60	90	10
29502-4112	IG	2.375	3.250	0.750	60	83	19	24620-4020	26R1	2.375	3.543	0.438	60	90	11
29503-4112	IG	2.375	3.250	0.750	60	83	19	29500-4727	IG	2.375	3.544	0.750	60	90	19
29502-5081	IG	2.375	3.255	0.750	60	83	19	29502-4727	IG	2.375	3.544	0.750	60	90	19
25113-7179	23	2.375	3.313	0.480	60	84	12	29699-0004	GD	2.375	3.600	1.222	60	91	31
25003-1657	23	2.375	3.350	0.375	60	85	10	21158-1672	63	2.375	3.623	0.375	60	92	10
25006-1657	23	2.375	3.350	0.375	60	85	10	21500-1672	63	2.375	3.623	0.375	60	92	10
21158-1657	63	2.375	3.350	0.375	60	85	10	21702-1673	62	2.375	3.623	0.437	60	92	11
21695-1657	63	2.375	3.350	0.375	60	85	10	21158-1673	63	2.375	3.623	0.437	60	92	11
21158-1658	63	2.375	3.350	0.437	60	85	11	29502-6144	IG	2.375	3.625	0.750	60	92	19
21158-4646	63	2.375	3.350	0.469	60	85	12	21702-1675	62	2.375	3.751	0.375	60	95	10
24802-1776	EQUAL	2.375	3.350	0.625	60	85	16	21158-1675	63	2.375	3.751	0.375	60	95	10
25113-8274	23	2.375	3.362	0.480	60	85	12	21500-1675	63	2.375	3.751	0.375	60	95	10
24802-5490	EQUAL	2.375	3.365	0.625	60	85	16	23548-6468	63R2	2.375	3.751	0.688	60	95	17
29502-5161	IG	2.375	3.371	0.750	60	86	19	21158-1678	63	2.375	3.875	0.375	60	98	10
21158-1660	63	2.375	3.372	0.375	60	86	10	21695-1678	63	2.375	3.875	0.375	60	98	10
24620-1857	26R1	2.375	3.372	0.438	60	86	11	21702-1680	62	2.375	3.875	0.500	60	98	13
21158-1661	63	2.375	3.372	0.438	60	86	11	24820-0892	EQUAL	2.375	3.875	0.500	60	98	13
21158-1662	63	2.375	3.372	0.500	60	86	13	29500-4619	IG	2.375	3.875	0.750	60	98	19
24060-1529	61	2.375	3.375	0.437	60	86	11	25058-5240	25	2.375	4.000	0.500	60	102	13
24610-2624	26	2.375	3.375	0.438	60	86	11	29520-6454	IG	2.375	4.500	0.750	60	114	19
25058-1637	25	2.375	3.375	0.469	60	86	12	21140-6003	54	2.375	5.125	0.625	60	130	16
24626-1652	26	2.375	3.375	0.500	60	86	13	29502-5043	IG	2.380	3.375	0.750	60	86	19
24627-1652	26	2.375	3.375	0.500	60	86	13	24802-3064	EQUAL	2.380	3.380	0.625	60	86	16
24600-1652	26	2.375	3.375	0.500	60	86	13	29502-6009	IG	2.386	4.250	0.750	61	108	19
24610-1652	26	2.375	3.375	0.500	60	86	13	29602-6918	GD	2.397	3.397	0.700	61	86	18
21003-4411	58	2.375	3.375	0.500	60	86	13	29502-4623	IG	2.400	3.375	0.750	61	86	19
24801-1654	EQUAL	2.375	3.375	0.625	60	86	16	29502-5289	IG	2.400	3.438	0.750	61	87	19
24802-1654	EQUAL	2.375	3.375	0.625	60	86	16	29502-4666	IG	2.400	3.500	0.750	61	89	19
29602-4149	GD	2.375	3.375	0.700	60	86	18	24802-3108	EQUAL	2.402	3.290	0.625	61	84	16
29500-4149	IG	2.375	3.375	0.750	60	86	19	21158-1681	63	2.406	3.125	0.375	61	79	10
29502-4149	IG	2.375	3.375	0.750	60	86	19	21695-1681	63	2.406	3.125	0.375	61	79	10
24802-3006	EQUAL	2.375	3.437	0.625	60	87	16	23550-2494	63T2	2.406	3.125	0.687	61	79	17
24824-3006	EQUAL	2.375	3.438	0.625	60	87	16	21158-0513	63	2.406	3.500	0.500	61	89	13
21158-1663	63	2.375	3.481	0.375	60	88	10	21158-1711	63	2.406	3.623	0.375	61	92	10
21695-1663	63	2.375	3.481	0.375	60	88	10	21158-1714	63	2.406	3.751	0.375	61	95	10

All dimensions are in inches. Preferred sizes are indicated with **bold** type face.

Sizes listed are for standard nitrile elements, except Models 25 and 62 which have PTFE elements. Other material available on inquiry only.



## Oil Seals by Model Number

Product Code	Model	Inches			MM			Product Code	Model	Inches			MM		
		ID	OD	Width	ID	OD	Width			ID	OD	Width	ID	OD	Width
21158-1720	63	2.406	4.003	0.375	61	102	10	21158-1726	63	2.438	3.147	0.375	62	80	10
29602-6901	GD	2.422	3.422	0.700	62	87	18	21702-8373	62	2.438	3.150	0.375	62	80	10
24802-3986	EQUAL	2.428	3.428	0.625	62	87	16	29502-5352	IG	2.438	3.188	0.750	62	81	19
29508-5255	IG	2.430	2.940	0.625	62	75	16	29516-7082	IG	2.438	3.188	0.976	62	81	25
29602-6998	GD	2.430	3.430	0.700	62	87	18	29598-0002	IG	2.438	3.188	0.976	62	81	25
29502-5687	IG	2.430	3.623	0.750	62	92	19	24816-2564	EQUAL	2.438	3.188	1.125	62	81	29
25004-2292	23	2.431	3.447	0.500	62	88	13	29616-7082	GD	2.438	3.188	1.265	62	81	32
25166-7430	23	2.431	3.447	0.688	62	88	17	21158-1729	63	2.438	3.189	0.375	62	81	10
29602-4847	GD	2.432	3.432	0.700	62	87	18	21919-1729	63	2.438	3.189	0.375	62	81	10
29502-4847	IG	2.432	3.432	0.750	62	87	19	24816-7004	EQUAL	2.438	3.192	1.062	62	81	27
24610-4931	26	2.432	3.444	0.500	62	87	13	24839-7004	EQUAL	2.438	3.192	1.125	62	81	29
24802-4597	EQUAL	2.433	4.049	0.625	62	103	16	29516-7141	IG	2.438	3.225	0.800	62	82	20
29607-7482	GD	2.435	3.434	0.625	62	87	16	29516-7168	IG	2.438	3.235	0.804	62	82	20
29502-6212	IG	2.435	3.435	0.750	62	87	19	21158-1732	63	2.438	3.246	0.375	62	82	10
29602-7283	GD	2.436	3.438	0.700	62	87	18	25003-1735	23	2.438	3.250	0.375	62	83	10
29507-4890	IG	2.437	2.930	0.625	62	74	16	21290-1735	63	2.438	3.250	0.375	62	83	10
24649-5361	26	2.437	3.125	0.375	62	79	10	21158-1735	63	2.438	3.250	0.375	62	83	10
21767-1723	62	2.437	3.125	0.375	62	79	10	21168-1735	63	2.438	3.250	0.375	62	83	10
21158-1725	63	2.437	3.125	0.500	62	79	13	24078-1737	61	2.438	3.250	0.500	62	83	13
23548-6487	63R2	2.437	3.125	0.687	62	79	17	23501-1737	63G1	2.438	3.250	0.500	62	83	13
24620-1726	26R1	2.437	3.147	0.375	62	80	10	29507-1942	IG	2.438	3.250	0.625	62	83	16
21158-8373	63	2.437	3.150	0.375	62	80	10	24802-1942	EQUAL	2.438	3.250	0.625	62	83	16
23548-7136	63R2	2.437	3.189	0.687	62	81	17	29502-6022	IG	2.438	3.287	0.750	62	83	19
24620-1735	26R1	2.437	3.250	0.375	62	83	10	29502-2141	IG	2.438	3.314	0.750	62	84	19
21695-1735	63	2.437	3.250	0.375	62	83	10	24802-1058	EQUAL	2.438	3.346	0.500	62	85	13
21158-1737	63	2.437	3.250	0.500	62	83	13	21158-8374	63	2.438	3.347	0.375	62	85	10
29502-5602	IG	2.437	3.250	0.750	62	83	19	21290-1738	63	2.438	3.350	0.375	62	85	10
25009-1736	23	2.437	3.313	0.375	62	84	10	21158-1738	63	2.438	3.350	0.375	62	85	10
25003-1736	23	2.437	3.313	0.375	62	84	10	29519-3294	IG	2.438	3.350	0.625	62	85	16
21158-1740	63	2.437	3.350	0.500	62	85	13	24802-3294	EQUAL	2.438	3.350	0.625	62	85	16
29621-6785	GD	2.437	3.375	0.625	62	86	16	29502-5614	IG	2.438	3.350	0.750	62	85	19
24627-0645	26	2.437	3.437	0.500	62	87	13	21158-1741	63	2.438	3.372	0.375	62	86	10
24610-0645	26	2.437	3.437	0.500	62	87	13	21158-1742	63	2.438	3.372	0.438	62	86	11
24802-1641	EQUAL	2.437	3.437	0.625	62	87	16	21695-1742	63	2.438	3.372	0.438	62	86	11
24829-1641	EQUAL	2.437	3.437	0.625	62	87	16	21158-1743	63	2.438	3.372	0.500	62	86	13
24844-1641	EQUAL	2.437	3.437	0.625	62	87	16	23078-6270	63F1	2.438	3.372	0.594	62	86	15
24802-4358	EQUAL	2.437	3.481	0.625	62	88	16	27223-1538	94	2.438	3.375	0.500	62	86	13
21158-1749	63	2.437	3.500	0.500	62	89	13	24801-3455	EQUAL	2.438	3.431	0.625	62	87	16
25003-1085	23	2.437	3.672	0.500	62	93	13	29519-1641	IG	2.438	3.438	0.625	62	87	16
29502-5288	IG	2.437	3.750	0.750	62	95	19	24801-1641	EQUAL	2.438	3.438	0.625	62	87	16
21695-1756	63	2.437	3.751	0.375	62	95	10	24819-1641	EQUAL	2.438	3.438	0.625	62	87	16
21158-1758	63	2.437	3.751	0.500	62	95	13	24824-1641	EQUAL	2.438	3.438	0.625	62	87	16
23550-7167	63T2	2.437	3.751	0.687	62	95	17	29602-4280	GD	2.438	3.438	0.700	62	87	18
21158-7927	63	2.437	3.937	0.375	62	100	10	29500-4280	IG	2.438	3.438	0.750	62	87	19
29602-6999	GD	2.437	4.019	0.700	62	102	18	29502-4280	IG	2.438	3.438	0.750	62	87	19
29502-6842	IG	2.437	4.173	0.750	62	106	19	29503-4280	IG	2.438	3.438	0.750	62	87	19
29501-4413	IG	2.437	5.120	0.750	62	130	19	21158-1744	63	2.438	3.481	0.375	62	88	10
29507-5406	IG	2.438	2.813	0.625	62	71	16	24600-1746	26	2.438	3.481	0.500	62	88	13
26001-7088	71	2.438	2.938	0.188	62	75	5	29602-6713	GD	2.438	3.481	0.700	62	88	18
24807-3748	EQUAL	2.438	2.938	0.690	62	75	18	24060-1747	61	2.438	3.500	0.375	62	89	10
24610-5704	26	2.438	3.125	0.312	62	79	8	21290-1747	63	2.438	3.500	0.375	62	89	10
21702-1723	62	2.438	3.125	0.375	62	79	10	21158-1747	63	2.438	3.500	0.375	62	89	10
21158-1723	63	2.438	3.125	0.375	62	79	10	24060-1539	61	2.438	3.500	0.438	62	89	11
21695-1723	63	2.438	3.125	0.375	62	79	10	25003-1749	23	2.438	3.500	0.500	62	89	13
29507-6426	IG	2.438	3.125	0.625	62	79	16	24626-1749	26	2.438	3.500	0.500	62	89	13
24807-1912	EQUAL	2.438	3.125	0.690	62	79	18	24600-1749	26	2.438	3.500	0.500	62	89	13

All dimensions are in inches. Preferred sizes are indicated with **bold** type face. Sizes listed are for standard nitrile elements, except Models 25 and 62 which have PTFE elements. Other material available on inquiry only.

## Oil Seals by Model Number

Product Code	Model	Inches			MM			Product Code	Model	Inches			MM		
		ID	OD	Width	ID	OD	Width			ID	OD	Width	ID	OD	Width
24801-3491	EQUAL	2.438	3.500	0.625	62	89	16	24600-1623	26	2.499	3.542	0.500	63	90	13
24802-3491	EQUAL	2.438	3.500	0.625	62	89	16	24063-2239	61	2.500	3.000	0.375	64	76	10
29602-6528	GD	2.438	3.500	0.700	62	89	18	24060-2239	61	2.500	3.000	0.375	64	76	10
29502-6528	IG	2.438	3.500	0.750	62	89	19	24062-2239	61	2.500	3.000	0.375	64	76	10
24610-1683	26	2.438	3.531	0.500	62	90	13	29507-5649	IG	2.500	3.000	0.625	64	76	16
21158-1750	63	2.438	3.543	0.375	62	90	10	24807-5809	EQUAL	2.500	3.000	0.690	64	76	18
21158-1752	63	2.438	3.543	0.500	62	90	13	26193-7532	76	2.500	3.062	0.250	64	78	6
24600-1621	26	2.438	3.547	0.500	62	90	13	26001-7089	71	2.500	3.125	0.250	64	79	6
25004-1161	23	2.438	3.563	0.625	62	91	16	24060-1541	61	2.500	3.125	0.312	64	79	8
21158-1753	63	2.438	3.623	0.375	62	92	10	24620-1686	26R1	2.500	3.125	0.313	64	79	8
24850-4690	EQUAL	2.438	3.625	0.625	62	92	16	24600-1686	26	2.500	3.125	0.313	64	79	8
21158-1756	63	2.438	3.751	0.375	62	95	10	24060-2995	61	2.500	3.125	0.375	64	79	10
29516-7139	IG	2.438	3.760	0.700	62	96	18	24614-1801	26	2.500	3.188	0.375	64	81	10
29616-7139	GD	2.438	3.760	0.994	62	96	25	24600-1801	26	2.500	3.188	0.375	64	81	10
29516-7192	IG	2.438	3.807	0.820	62	97	21	21163-1801	63	2.500	3.188	0.375	64	81	10
21158-1759	63	2.438	3.876	0.375	62	98	10	29516-7083	IG	2.500	3.188	0.976	64	81	25
24610-5321	26	2.438	4.000	0.500	62	102	13	24610-1801	26	2.500	3.189	0.375	64	81	10
21158-1762	63	2.438	4.003	0.375	62	102	10	21702-1801	62	2.500	3.189	0.375	64	81	10
21158-1764	63	2.438	4.003	0.500	62	102	13	21695-1801	63	2.500	3.189	0.375	64	81	10
29502-6199	IG	2.438	4.375	0.750	62	111	19	21158-1801	63	2.500	3.189	0.375	64	81	10
29699-0001	GD	2.438	7.875	0.700	62	200	18	21959-1801	67	2.500	3.189	0.375	64	81	10
24600-1685	26	2.440	3.250	0.500	62	83	13	21923-1801	67	2.500	3.189	0.375	64	81	10
24802-3154	EQUAL	2.440	3.440	0.625	62	87	16	21823-1801	68	2.500	3.189	0.375	64	81	10
24627-3368	26	2.440	3.693	0.469	62	94	12	21158-1803	63	2.500	3.189	0.500	64	81	13
24060-4362	61	2.441	3.150	0.315	62	80	8	29507-2016	IG	2.500	3.189	0.625	64	81	16
24801-3161	EQUAL	2.441	3.346	0.630	62	85	16	24807-2025	EQUAL	2.500	3.189	0.690	64	81	18
29609-5015	GD	2.441	3.937	0.374	62	100	10	24816-7035	EQUAL	2.500	3.192	1.062	64	81	27
29619-3870	GD	2.441	3.937	0.626	62	100	16	24600-3216	26	2.500	3.228	0.315	64	82	8
29507-5139	IG	2.441	2.992	0.625	62	76	16	25003-1804	23	2.500	3.246	0.375	64	82	10
24064-8373	61	2.441	3.150	0.394	62	80	10	21158-1804	63	2.500	3.246	0.375	64	82	10
24060-8373	61	2.441	3.150	0.394	62	80	10	21823-1804	68	2.500	3.246	0.375	64	82	10
25003-0793	23	2.441	3.346	0.394	62	85	10	21158-1806	63	2.500	3.246	0.500	64	82	13
24801-5488	EQUAL	2.441	3.346	0.625	62	85	16	26001-7090	71	2.500	3.250	0.250	64	83	6
29502-4846	IG	2.441	3.441	0.750	62	87	19	25003-1807	23	2.500	3.250	0.375	64	83	10
29602-6581	GD	2.441	3.465	0.700	62	88	18	25009-1807	23	2.500	3.250	0.375	64	83	10
24610-6747	26	2.441	3.937	0.500	62	100	13	25004-1807	23	2.500	3.250	0.375	64	83	10
29518-6511	IG	2.441	3.937	0.875	62	100	22	25058-1807	25	2.500	3.250	0.375	64	83	10
29500-4476	IG	2.441	3.948	0.750	62	100	19	24627-2699	26	2.500	3.250	0.375	64	83	10
29502-4887	IG	2.450	3.450	0.750	62	88	19	24610-2699	26	2.500	3.250	0.375	64	83	10
21158-1765	63	2.469	3.189	0.375	63	81	10	24060-1807	61	2.500	3.250	0.375	64	83	10
21158-1771	63	2.469	3.250	0.375	63	83	10	21695-1804	63	2.500	3.250	0.375	64	83	10
21158-1774	63	2.469	3.350	0.375	63	85	10	21475-1807	63	2.500	3.250	0.375	64	83	10
21158-1783	63	2.469	3.500	0.375	63	89	10	21158-1807	63	2.500	3.250	0.375	64	83	10
21158-1786	63	2.469	3.543	0.375	63	90	10	21168-1807	63	2.500	3.250	0.375	64	83	10
29602-6854	GD	2.475	3.475	0.700	63	88	18	21795-1807	63	2.500	3.250	0.375	64	83	10
24610-5084	26	2.479	3.543	0.500	63	90	13	21695-1807	63	2.500	3.250	0.375	64	83	10
29519-5756	IG	2.480	3.268	0.625	63	83	16	21481-1807	66	2.500	3.250	0.375	64	83	10
29507-5974	IG	2.480	3.346	0.625	63	85	16	21527-1807	66	2.500	3.250	0.375	64	83	10
29500-5569	IG	2.480	3.480	0.750	63	88	19	21528-1807	67	2.500	3.250	0.375	64	83	10
29502-5569	IG	2.480	3.480	0.750	63	88	19	21823-1807	68	2.500	3.250	0.375	64	83	10
24802-3568	EQUAL	2.480	3.543	0.625	63	90	16	24610-1808	26	2.500	3.250	0.437	64	83	11
24602-1192	26	2.480	3.189	0.394	63	81	10	24060-1808	61	2.500	3.250	0.437	64	83	11
29602-6635	GD	2.489	3.239	0.700	63	82	18	21795-1808	63	2.500	3.250	0.438	64	83	11
24600-1757	26	2.489	3.250	0.312	63	83	8	21158-1808	63	2.500	3.250	0.438	64	83	11
29507-5316	IG	2.490	2.875	0.625	63	73	16	25058-1809	25	2.500	3.250	0.500	64	83	13
29502-5628	IG	2.498	3.368	0.750	63	86	19	24610-1809	26	2.500	3.250	0.500	64	83	13

All dimensions are in inches. Preferred sizes are indicated with **bold** type face.

Sizes listed are for standard nitrile elements, except Models 25 and 62 which have PTFE elements. Other material available on inquiry only.

## Oil Seals by Model Number

Product Code	Model	Inches			MM			Product Code	Model	Inches			MM		
		ID	OD	Width	ID	OD	Width			ID	OD	Width	ID	OD	Width
23501-1809	63G1	2.500	3.250	0.500	64	83	13	21695-1819	63	2.500	3.500	0.375	64	89	10
21695-1809	63	2.500	3.250	0.500	64	83	13	25003-1820	23	2.500	3.500	0.437	64	89	11
21158-1809	63	2.500	3.250	0.500	64	83	13	25006-1820	23	2.500	3.500	0.437	64	89	11
21168-1809	63	2.500	3.250	0.500	64	83	13	24627-1820	26	2.500	3.500	0.437	64	89	11
24801-1809	EQUAL	2.500	3.250	0.500	64	83	13	24600-1820	26	2.500	3.500	0.437	64	89	11
23078-6506	63F1	2.500	3.250	0.594	64	83	15	24610-1820	26	2.500	3.500	0.437	64	89	11
29507-0991	IG	2.500	3.250	0.625	64	83	16	24060-1820	61	2.500	3.500	0.437	64	89	11
29619-0991	GD	2.500	3.250	0.625	64	83	16	21290-1820	63	2.500	3.500	0.437	64	89	11
24819-0991	EQUAL	2.500	3.250	0.625	64	83	16	25004-1820	23	2.500	3.500	0.438	64	89	11
24822-0991	EQUAL	2.500	3.250	0.625	64	83	16	24626-1820	26	2.500	3.500	0.438	64	89	11
24832-0991	EQUAL	2.500	3.250	0.625	64	83	16	24602-1820	26	2.500	3.500	0.438	64	89	11
23548-7564	63R2	2.500	3.250	0.688	64	83	17	24064-1820	61	2.500	3.500	0.438	64	89	11
29602-4111	GD	2.500	3.250	0.700	64	83	18	24062-1820	61	2.500	3.500	0.438	64	89	11
29500-4111	IG	2.500	3.250	0.750	64	83	19	21158-1820	63	2.500	3.500	0.438	64	89	11
29502-4111	IG	2.500	3.250	0.750	64	83	19	21823-1820	68	2.500	3.500	0.438	64	89	11
29503-4111	IG	2.500	3.250	0.750	64	83	19	25003-1821	23	2.500	3.500	0.500	64	89	13
29520-4111	IG	2.500	3.250	0.750	64	83	19	25006-1821	23	2.500	3.500	0.500	64	89	13
24802-0991	EQUAL	2.500	3.251	0.625	64	83	16	25004-1821	23	2.500	3.500	0.500	64	89	13
29502-6192	IG	2.500	3.256	0.750	64	83	19	24610-1812	26	2.500	3.500	0.500	64	89	13
29502-6465	IG	2.500	3.275	0.750	64	83	19	24683-1821	26	2.500	3.500	0.500	64	89	13
29502-6038	IG	2.500	3.313	0.750	64	84	19	24600-1821	26	2.500	3.500	0.500	64	89	13
24600-1787	26	2.500	3.350	0.250	64	85	6	24610-1821	26	2.500	3.500	0.500	64	89	13
21159-1810	63	2.500	3.350	0.375	64	85	10	21702-1821	62	2.500	3.500	0.500	64	89	13
21158-1810	63	2.500	3.350	0.375	64	85	10	21160-1821	63	2.500	3.500	0.500	64	89	13
21695-1810	63	2.500	3.350	0.375	64	85	10	21158-1821	63	2.500	3.500	0.500	64	89	13
21158-1812	63	2.500	3.350	0.500	64	85	13	21457-1821	63	2.500	3.500	0.500	64	89	13
21290-1813	63	2.500	3.372	0.375	64	86	10	21168-1821	63	2.500	3.500	0.500	64	89	13
21158-1813	63	2.500	3.372	0.375	64	86	10	21695-1821	63	2.500	3.500	0.500	64	89	13
21158-1815	63	2.500	3.372	0.500	64	86	13	24820-1821	EQUAL	2.500	3.500	0.500	64	89	13
23078-9093	63F1	2.500	3.372	0.594	64	86	15	29507-1818	IG	2.500	3.500	0.625	64	89	16
25003-9691	23	2.500	3.375	0.375	64	86	10	29519-1818	IG	2.500	3.500	0.625	64	89	16
24627-3482	26	2.500	3.375	0.375	64	86	10	29619-1818	GD	2.500	3.500	0.625	64	89	16
24627-3335	26	2.500	3.375	0.437	64	86	11	24801-1818	EQUAL	2.500	3.500	0.625	64	89	16
24610-3335	26	2.500	3.375	0.437	64	86	11	24802-1818	EQUAL	2.500	3.500	0.625	64	89	16
24060-1544	61	2.500	3.375	0.437	64	86	11	24805-1818	EQUAL	2.500	3.500	0.625	64	89	16
21795-1544	63	2.500	3.375	0.437	64	86	11	24813-1818	EQUAL	2.500	3.500	0.625	64	89	16
24801-1788	EQUAL	2.500	3.375	0.500	64	86	13	24824-1818	EQUAL	2.500	3.500	0.625	64	89	16
24801-1212	EQUAL	2.500	3.375	0.625	64	86	16	24835-1818	EQUAL	2.500	3.500	0.625	64	89	16
24802-1212	EQUAL	2.500	3.375	0.625	64	86	16	23547-6465	63R1	2.500	3.500	0.688	64	89	17
29502-6141	IG	2.500	3.375	0.750	64	86	19	23548-6465	63R2	2.500	3.500	0.688	64	89	17
24802-3004	EQUAL	2.500	3.433	0.625	64	87	16	23626-6465	63T2	2.500	3.500	0.688	64	89	17
24801-5785	EQUAL	2.500	3.438	0.625	64	87	16	23550-6465	63T2	2.500	3.500	0.688	64	89	17
21158-1816	63	2.500	3.481	0.375	64	88	10	29602-4150	GD	2.500	3.500	0.700	64	89	18
21482-1816	66	2.500	3.481	0.375	64	88	10	23078-5387	63F1	2.500	3.500	0.750	64	89	19
21158-1817	63	2.500	3.481	0.437	64	88	11	29500-4150	IG	2.500	3.500	0.750	64	89	19
21158-1818	63	2.500	3.481	0.500	64	88	13	29502-4150	IG	2.500	3.500	0.750	64	89	19
25003-1819	23	2.500	3.500	0.375	64	89	10	29503-4150	IG	2.500	3.500	0.750	64	89	19
25009-1819	23	2.500	3.500	0.375	64	89	10	29519-4150	IG	2.500	3.500	0.750	64	89	19
24622-1819	26R1	2.500	3.500	0.375	64	89	10	29520-4150	IG	2.500	3.500	0.750	64	89	19
24620-1819	26R1	2.500	3.500	0.375	64	89	10	24801-1823	EQUAL	2.500	3.540	0.500	64	90	13
21005-1819	58	2.500	3.500	0.375	64	89	10	21695-1822	63	2.500	3.543	0.375	64	90	10
21702-1819	62	2.500	3.500	0.375	64	89	10	21158-1822	63	2.500	3.543	0.375	64	90	10
21159-1819	63	2.500	3.500	0.375	64	89	10	21500-1822	63	2.500	3.543	0.375	64	90	10
21475-1819	63	2.500	3.500	0.375	64	89	10	21158-1823	63	2.500	3.543	0.437	64	90	11
21158-1819	63	2.500	3.500	0.375	64	89	10	21158-1824	63	2.500	3.543	0.500	64	90	13
21163-1819	63	2.500	3.500	0.375	64	89	10	24802-2662	EQUAL	2.500	3.543	0.625	64	90	16

All dimensions are in inches. Preferred sizes are indicated with **bold** type face. Sizes listed are for standard nitrile elements, except Models 25 and 62 which have PTFE elements. Other material available on inquiry only.

## Oil Seals by Model Number

Product Code	Model	Inches			MM			Product Code	Model	Inches			MM		
		ID	OD	Width	ID	OD	Width			ID	OD	Width	ID	OD	Width
24803-2662	EQUAL	2.500	3.543	0.625	64	90	16	21500-1831	63	2.500	3.875	0.375	64	98	10
23548-4844	63R2	2.500	3.543	0.687	64	90	17	24610-3252	26	2.500	3.875	0.438	64	98	11
29500-4683	IG	2.500	3.543	0.750	64	90	19	24620-5758	26R1	2.500	3.875	0.468	64	98	12
29502-4683	IG	2.500	3.543	0.750	64	90	19	29502-5045	IG	2.500	3.875	0.750	64	98	19
24803-4866	EQUAL	2.500	3.547	0.625	64	90	16	23548-4734	63R2	2.500	3.876	0.687	64	98	17
24801-1156	EQUAL	2.500	3.550	0.625	64	90	16	21702-4845	62	2.500	3.938	0.375	64	100	10
24802-3007	EQUAL	2.500	3.563	0.625	64	91	16	21158-4845	63	2.500	3.938	0.375	64	100	10
29502-5982	IG	2.500	3.600	0.750	64	91	19	29502-6351	IG	2.500	3.938	0.750	64	100	19
21158-1825	63	2.500	3.623	0.375	64	92	10	29500-5143	IG	2.500	4.000	0.750	64	102	19
21527-1825	66	2.500	3.623	0.375	64	92	10	29502-5143	IG	2.500	4.000	0.750	64	102	19
24600-1826	26	2.500	3.623	0.437	64	92	11	24600-3988	26	2.500	4.003	0.375	64	102	10
21158-1826	63	2.500	3.623	0.437	64	92	11	21475-1834	63	2.500	4.003	0.375	64	102	10
24610-5430	26	2.500	3.623	0.468	64	92	12	21158-1834	63	2.500	4.003	0.375	64	102	10
21159-1827	63	2.500	3.623	0.500	64	92	13	29609-3988	GD	2.500	4.003	0.375	64	102	10
29507-1252	IG	2.500	3.623	0.625	64	92	16	21158-1836	63	2.500	4.003	0.500	64	102	13
29619-1252	GD	2.500	3.623	0.625	64	92	16	23548-6966	63R2	2.500	4.003	0.688	64	102	17
24801-1252	EQUAL	2.500	3.623	0.625	64	92	16	24801-4631	EQUAL	2.500	4.250	0.625	64	108	16
29502-5042	IG	2.500	3.623	0.750	64	92	19	29602-7480	GD	2.500	4.250	0.700	64	108	18
29609-6926	GD	2.500	3.625	0.375	64	92	10	29516-7174	IG	2.500	4.370	0.722	64	111	18
24610-1826	26	2.500	3.625	0.437	64	92	11	24802-1834	EQUAL	2.500	4.375	0.625	64	111	16
25004-1827	23	2.500	3.625	0.500	64	92	13	29602-4353	GD	2.500	4.375	0.700	64	111	18
24610-0893	26	2.500	3.625	0.500	64	92	13	29502-4353	IG	2.500	4.375	0.750	64	111	19
24610-1827	26	2.500	3.625	0.500	64	92	13	29520-4353	IG	2.500	4.375	0.750	64	111	19
24801-1951	EQUAL	2.500	3.625	0.625	64	92	16	29502-6688	IG	2.500	4.415	0.750	64	112	19
24802-1951	EQUAL	2.500	3.625	0.625	64	92	16	24806-3402	EQUAL	2.500	4.418	0.625	64	112	16
24824-1951	EQUAL	2.500	3.625	0.625	64	92	16	29519-7461	IG	2.500	4.420	0.640	64	112	16
29519-5643	IG	2.500	3.625	0.640	64	92	16	29502-6500	IG	2.500	4.440	0.750	64	113	19
23548-8930	63R2	2.500	3.625	0.688	64	92	17	24060-1547	61	2.500	4.500	0.437	64	114	11
29502-5793	IG	2.500	3.625	0.750	64	92	19	29502-6539	IG	2.500	4.500	0.750	64	114	19
21158-5080	63	2.500	3.671	0.375	64	93	10	29502-5558	IG	2.500	4.724	0.750	64	120	19
24610-5631	26	2.500	3.688	0.468	64	94	12	24125-4737	61	2.500	4.750	0.375	64	121	10
24801-3061	EQUAL	2.500	3.725	0.625	64	95	16	29502-5778	IG	2.500	4.875	0.750	64	124	19
24600-1828	26	2.500	3.750	0.375	64	95	10	29500-4592	IG	2.500	4.938	0.750	64	125	19
24610-1828	26	2.500	3.750	0.375	64	95	10	29502-5579	IG	2.500	5.118	0.750	64	130	19
21391-1828	63	2.500	3.750	0.375	64	95	10	29602-6937	GD	2.502	3.502	0.700	64	89	18
21372-1828	63	2.500	3.750	0.375	64	95	10	29602-6938	GD	2.502	4.417	0.700	64	112	18
21500-1828	63	2.500	3.750	0.375	64	95	10	24802-3099	EQUAL	2.505	3.505	0.625	64	89	16
29609-1828	GD	2.500	3.750	0.375	64	95	10	29502-6247	IG	2.519	3.318	0.750	64	84	19
24610-3076	26	2.500	3.750	0.469	64	95	12	24600-0829	26	2.519	3.464	0.472	64	88	12
24620-3987	26R1	2.500	3.750	0.688	64	95	17	29507-6092	IG	2.520	3.346	0.625	64	85	16
29500-4374	IG	2.500	3.750	0.750	64	95	19	29502-5762	IG	2.520	3.520	0.750	64	89	19
29502-4374	IG	2.500	3.750	0.750	64	95	19	29500-4747	IG	2.520	3.740	0.750	64	95	19
21158-1828	63	2.500	3.751	0.375	64	95	10	24801-4195	EQUAL	2.520	4.250	0.625	64	108	16
21168-1828	63	2.500	3.751	0.375	64	95	10	24807-4132	EQUAL	2.530	3.287	0.690	64	83	18
21695-1828	63	2.500	3.751	0.375	64	95	10	29502-4483	IG	2.530	3.287	0.750	64	83	19
21823-1828	68	2.500	3.751	0.375	64	95	10	29502-5759	IG	2.530	3.530	0.750	64	90	19
21158-1829	63	2.500	3.751	0.437	64	95	11	21163-1840	63	2.531	3.250	0.375	64	83	10
21158-1830	63	2.500	3.751	0.500	64	95	13	21158-1840	63	2.531	3.250	0.375	64	83	10
21168-1830	63	2.500	3.751	0.500	64	95	13	21158-8377	63	2.531	3.347	0.375	64	85	10
21695-1830	63	2.500	3.751	0.500	64	95	13	21158-1846	63	2.531	3.372	0.375	64	86	10
23626-6566	63T2	2.500	3.751	0.687	64	95	17	21158-1849	63	2.531	3.481	0.375	64	88	10
23548-6566	63R2	2.500	3.751	0.688	64	95	17	21158-1852	63	2.531	3.500	0.375	64	89	10
23550-6566	63T2	2.500	3.751	0.688	64	95	17	21158-1855	63	2.531	3.543	0.375	64	90	10
23683-6566	67R2	2.500	3.751	0.688	64	95	17	21158-1863	63	2.531	3.751	0.500	64	95	13
21159-1831	63	2.500	3.875	0.375	64	98	10	21158-1864	63	2.531	3.876	0.375	64	98	10
21158-1831	63	2.500	3.875	0.375	64	98	10	21158-1867	63	2.531	4.003	0.375	64	102	10

All dimensions are in inches. Preferred sizes are indicated with **bold** type face.

Sizes listed are for standard nitrile elements, except Models 25 and 62 which have PTFE elements. Other material available on inquiry only.

## Oil Seals by Model Number

Product Code	Model	Inches			MM			Product Code	Model	Inches			MM		
		ID	OD	Width	ID	OD	Width			ID	OD	Width	ID	OD	Width
24629-3459	26R1	2.531	4.725	0.375	64	120	10	29502-4966	IG	2.559	3.937	0.750	65	100	19
24620-3459	26R1	2.531	4.725	0.375	64	120	10	24610-5597	26	2.559	4.134	0.500	65	105	13
27223-8959	94	2.531	4.725	0.375	64	120	10	29502-5646	IG	2.559	4.134	0.750	65	105	19
29502-5001	IG	2.540	3.540	0.750	65	90	19	29500-5367	IG	2.559	4.331	0.750	65	110	19
29507-5013	IG	2.543	3.543	0.625	65	90	16	29502-5367	IG	2.559	4.331	0.750	65	110	19
24802-3234	EQUAL	2.550	3.550	0.625	65	90	16	26063-2455	57	2.559	4.724	0.315	65	120	8
29602-5718	GD	2.550	3.550	0.700	65	90	18	29609-6717	GD	2.559	4.724	0.375	65	120	10
29502-5718	IG	2.550	3.550	0.750	65	90	19	29519-6908	IG	2.559	4.724	0.625	65	120	16
29519-6447	IG	2.550	3.600	0.625	65	91	16	29502-5803	IG	2.559	4.724	0.750	65	120	19
29502-5706	IG	2.554	3.375	0.750	65	86	19	29518-6790	IG	2.559	4.724	0.875	65	120	22
29602-4772	GD	2.554	3.554	0.700	65	90	18	24600-5964	26	2.559	3.031	0.276	65	77	7
29502-4772	IG	2.554	3.554	0.750	65	90	19	24600-5963	26	2.559	3.031	0.354	65	77	9
29507-6916	IG	2.556	3.125	0.625	65	79	16	24060-1847	61	2.559	3.150	0.394	65	80	10
29507-5016	IG	2.556	3.556	0.625	65	90	16	24600-1798	26	2.559	3.346	0.394	65	85	10
29602-4630	GD	2.558	3.558	0.700	65	90	18	24125-0710	61	2.559	3.346	0.394	65	85	10
29502-4630	IG	2.558	3.558	0.750	65	90	19	24063-4355	61	2.559	3.346	0.437	65	85	11
29602-6382	GD	2.558	3.561	0.700	65	90	18	29619-2816	GD	2.559	3.346	0.626	65	85	16
29507-6594	IG	2.559	2.953	0.625	65	75	16	24629-1859	26R1	2.559	3.465	0.472	65	88	12
29507-6414	IG	2.559	3.150	0.625	65	80	16	24620-1859	26R1	2.559	3.465	0.472	65	88	12
29507-5544	IG	2.559	3.228	0.625	65	82	16	24606-1859	26R1	2.559	3.465	0.472	65	88	12
25003-0710	23	2.559	3.346	0.375	65	85	10	29519-1883	IG	2.559	3.543	0.626	65	90	16
25006-0710	23	2.559	3.346	0.375	65	85	10	24060-6300	61	2.559	3.937	0.394	65	100	10
29609-6889	GD	2.559	3.346	0.375	65	85	10	24648-5623	26	2.559	4.134	0.472	65	105	12
24802-2816	EQUAL	2.559	3.346	0.625	65	85	16	21158-1861	63	2.560	3.544	0.315	65	90	8
29502-4532	IG	2.559	3.346	0.750	65	85	19	29507-3170	IG	2.560	3.560	0.625	65	90	16
24060-0710	61	2.559	3.347	0.394	65	85	10	24802-3170	EQUAL	2.560	3.560	0.625	65	90	16
29516-7181	IG	2.559	3.366	0.765	65	85	19	24821-3170	EQUAL	2.560	3.560	0.625	65	90	16
24802-1858	EQUAL	2.559	3.465	0.625	65	88	16	24822-3170	EQUAL	2.560	3.560	0.625	65	90	16
24803-1858	EQUAL	2.559	3.465	0.625	65	88	16	29502-5760	IG	2.560	3.560	0.750	65	90	19
29502-6457	IG	2.559	3.465	0.750	65	88	19	29602-7248	GD	2.562	3.312	0.700	65	84	18
24802-1807	EQUAL	2.559	3.500	0.625	65	89	16	25010-1885	23	2.562	3.500	0.375	65	89	10
29502-5663	IG	2.559	3.500	0.750	65	89	19	21158-1890	63	2.562	3.543	0.500	65	90	13
25010-9162	23	2.559	3.543	0.375	65	90	10	29505-0646	IG	2.562	3.562	0.500	65	90	13
25003-9162	23	2.559	3.543	0.375	65	90	10	29507-1251	IG	2.562	3.562	0.625	65	90	16
25004-9162	23	2.559	3.543	0.375	65	90	10	29500-4281	IG	2.562	3.562	0.750	65	90	19
24060-0729	61	2.559	3.543	0.394	65	90	10	29502-4281	IG	2.562	3.562	0.750	65	90	19
21767-2778	62	2.559	3.543	0.500	65	90	13	29505-5790	IG	2.562	3.564	0.500	65	91	13
24802-1883	EQUAL	2.559	3.543	0.625	65	90	16	21158-1893	63	2.562	3.623	0.500	65	92	13
24819-1883	EQUAL	2.559	3.543	0.625	65	90	16	25003-1894	23	2.562	3.751	0.375	65	95	10
29602-4721	GD	2.559	3.543	0.700	65	90	18	29602-6959	GD	2.562	3.938	0.700	65	100	18
29500-4721	IG	2.559	3.543	0.750	65	90	19	29502-6959	IG	2.562	3.938	0.750	65	100	19
29502-4721	IG	2.559	3.543	0.750	65	90	19	21695-1900	63	2.562	4.003	0.375	65	102	10
29520-4721	IG	2.559	3.543	0.750	65	90	19	21158-1870	63	2.563	3.246	0.375	65	82	10
24821-3417	EQUAL	2.559	3.559	0.500	65	90	13	21695-1870	63	2.563	3.246	0.375	65	82	10
29519-6644	IG	2.559	3.559	0.625	65	90	16	21158-1873	63	2.563	3.250	0.375	65	83	10
29602-6552	GD	2.559	3.580	0.700	65	91	18	21767-8378	62	2.563	3.347	0.375	65	85	10
29519-3114	IG	2.559	3.583	0.625	65	91	16	21158-8378	63	2.563	3.347	0.375	65	85	10
29602-5795	GD	2.559	3.583	0.700	65	91	18	21695-8378	63	2.563	3.347	0.375	65	85	10
29502-5795	IG	2.559	3.583	0.750	65	91	19	21158-1879	63	2.563	3.372	0.375	65	86	10
24802-3735	EQUAL	2.559	3.620	0.625	65	92	16	24801-1129	EQUAL	2.563	3.437	0.500	65	87	13
29502-6534	IG	2.559	3.622	0.750	65	92	19	25003-2617	23	2.563	3.438	0.375	65	87	10
24060-4474	61	2.559	3.740	0.437	65	95	11	25003-1885	23	2.563	3.500	0.375	65	89	10
24063-4474	61	2.559	3.740	0.437	65	95	11	25006-1885	23	2.563	3.500	0.375	65	89	10
29516-5411	IG	2.559	3.760	0.788	65	96	20	24600-1627	26	2.563	3.500	0.375	65	89	10
29518-6342	IG	2.559	3.809	0.875	65	97	22	21158-1885	63	2.563	3.500	0.375	65	89	10
29519-6780	IG	2.559	3.937	0.625	65	100	16	21695-1885	63	2.563	3.500	0.375	65	89	10

All dimensions are in inches. Preferred sizes are indicated with **bold** type face. Sizes listed are for standard nitrile elements, except Models 25 and 62 which have PTFE elements. Other material available on inquiry only.

## Oil Seals by Model Number

Product Code	Model	Inches			MM			Product Code	Model	Inches			MM		
		ID	OD	Width	ID	OD	Width			ID	OD	Width	ID	OD	Width
21158-1886	63	2.563	3.500	0.437	65	89	11	21920-1933	66	2.625	3.372	0.375	67	86	10
21168-1886	63	2.563	3.500	0.437	65	89	11	21527-1933	66	2.625	3.372	0.375	67	86	10
21158-1887	63	2.563	3.500	0.500	65	89	13	21158-1935	63	2.625	3.372	0.500	67	86	13
23078-6700	63F1	2.563	3.500	0.594	65	89	15	24610-2801	26	2.625	3.375	0.375	67	86	10
29502-6051	IG	2.563	3.500	0.750	65	89	19	24060-5407	61	2.625	3.375	0.375	67	86	10
24801-1887	EQUAL	2.563	3.502	0.625	65	89	16	21158-5407	63	2.625	3.375	0.375	67	86	10
24802-1887	EQUAL	2.563	3.502	0.625	65	89	16	21695-5407	63	2.625	3.375	0.375	67	86	10
21290-1888	63	2.563	3.543	0.375	65	90	10	24600-1838	26	2.625	3.375	0.437	67	86	11
21158-1888	63	2.563	3.543	0.375	65	90	10	29507-1962	IG	2.625	3.375	0.625	67	86	16
24801-1251	EQUAL	2.563	3.563	0.625	65	91	16	29519-1962	IG	2.625	3.375	0.625	67	86	16
24802-1251	EQUAL	2.563	3.563	0.625	65	91	16	24801-1962	EQUAL	2.625	3.375	0.625	67	86	16
21158-1892	63	2.563	3.623	0.438	65	92	11	24802-1962	EQUAL	2.625	3.375	0.625	67	86	16
29502-6151	IG	2.563	3.750	0.750	65	95	19	25113-5524	23	2.625	3.435	0.480	67	87	12
25010-1894	23	2.563	3.751	0.375	65	95	10	21158-1936	63	2.625	3.481	0.375	67	88	10
25004-1894	23	2.563	3.751	0.375	65	95	10	23501-0719	63G1	2.625	3.484	0.500	67	88	13
21158-1894	63	2.563	3.751	0.375	65	95	10	29602-4332	GD	2.625	3.484	0.700	67	88	18
21695-1894	63	2.563	3.751	0.375	65	95	10	29502-4332	IG	2.625	3.484	0.750	67	88	19
21158-1896	63	2.563	3.751	0.500	65	95	13	24802-1203	EQUAL	2.625	3.489	0.625	67	89	16
21158-1897	63	2.563	3.875	0.375	65	98	10	25003-1939	23	2.625	3.500	0.375	67	89	10
24626-3546	26	2.563	3.888	0.750	65	99	19	25058-1939	25	2.625	3.500	0.375	67	89	10
21482-6300	66	2.563	3.937	0.375	65	100	10	24626-1939	26	2.625	3.500	0.375	67	89	10
21158-6300	63	2.563	3.938	0.375	65	100	10	24600-1939	26	2.625	3.500	0.375	67	89	10
27223-6300	94	2.563	3.938	0.375	65	100	10	24126-1939	61	2.625	3.500	0.375	67	89	10
21158-1900	63	2.563	4.003	0.375	65	102	10	21702-1939	62	2.625	3.500	0.375	67	89	10
21158-1902	63	2.563	4.003	0.500	65	102	13	21290-1939	63	2.625	3.500	0.375	67	89	10
24802-3244	EQUAL	2.563	4.125	0.625	65	105	16	21158-1939	63	2.625	3.500	0.375	67	89	10
29602-6743	GD	2.565	3.565	0.700	65	91	18	21163-1939	63	2.625	3.500	0.375	67	89	10
29516-7183	IG	2.566	3.760	0.700	65	96	18	21168-1939	63	2.625	3.500	0.375	67	89	10
24802-3016	EQUAL	2.569	3.569	0.625	65	91	16	21695-1939	63	2.625	3.500	0.375	67	89	10
24060-2266	61	2.570	3.250	0.375	65	83	10	21698-1940	63	2.625	3.500	0.437	67	89	11
29602-6810	GD	2.585	3.598	0.700	66	91	18	25003-1941	23	2.625	3.500	0.500	67	89	13
29502-6188	IG	2.585	4.000	0.750	66	102	19	23502-1941	63G1	2.625	3.500	0.500	67	89	13
29602-7309	GD	2.596	3.596	0.700	66	91	18	21158-1941	63	2.625	3.500	0.500	67	89	13
24801-1747	EQUAL	2.598	3.386	0.500	66	86	13	24801-1941	EQUAL	2.625	3.500	0.500	67	89	13
29507-6677	IG	2.618	3.250	0.625	66	83	16	24801-1893	EQUAL	2.625	3.500	0.625	67	89	16
29502-5154	IG	2.619	3.682	0.750	67	94	19	24802-1893	EQUAL	2.625	3.500	0.625	67	89	16
29502-6309	IG	2.620	3.500	0.750	67	89	19	24829-1893	EQUAL	2.625	3.500	0.625	67	89	16
24610-3213	26	2.621	3.371	0.375	67	86	10	23052-7187	63R1	2.625	3.500	0.688	67	89	17
24807-3831	EQUAL	2.622	3.046	0.690	67	77	18	23547-7187	63R1	2.625	3.500	0.688	67	89	17
24807-3835	EQUAL	2.622	3.346	0.690	67	85	18	23769-7187	63R2	2.625	3.500	0.688	67	89	17
29602-6638	GD	2.622	3.622	0.700	67	92	18	23548-7187	63R2	2.625	3.500	0.688	67	89	17
29602-6906	GD	2.623	3.623	0.700	67	92	18	29602-4438	GD	2.625	3.500	0.700	67	89	18
29507-7322	IG	2.625	3.063	0.625	67	78	16	29500-4438	IG	2.625	3.500	0.750	67	89	19
26001-7092	71	2.625	3.250	0.188	67	83	5	29502-4438	IG	2.625	3.500	0.750	67	89	19
24060-1549	61	2.625	3.250	0.312	67	83	8	29502-5572	IG	2.625	3.535	0.750	67	90	19
29607-1976	GD	2.625	3.250	0.625	67	83	16	25003-1942	23	2.625	3.543	0.375	67	90	10
21158-1930	63	2.625	3.350	0.375	67	85	10	21158-1942	63	2.625	3.543	0.375	67	90	10
21527-1930	66	2.625	3.350	0.375	67	85	10	21695-1942	63	2.625	3.543	0.375	67	90	10
21158-5398	63	2.625	3.350	0.469	67	85	12	21158-1944	63	2.625	3.543	0.500	67	90	13
21158-1932	63	2.625	3.350	0.500	67	85	13	29502-5163	IG	2.625	3.543	0.750	67	90	19
29507-5953	IG	2.625	3.350	0.625	67	85	16	21158-1945	63	2.625	3.623	0.375	67	92	10
24802-2520	EQUAL	2.625	3.371	0.625	67	86	16	21695-1945	63	2.625	3.623	0.375	67	92	10
21159-1933	63	2.625	3.372	0.375	67	86	10	21527-1945	66	2.625	3.623	0.375	67	92	10
21158-1933	63	2.625	3.372	0.375	67	86	10	21158-1946	63	2.625	3.623	0.437	67	92	11
21168-1933	63	2.625	3.372	0.375	67	86	10	21158-1947	63	2.625	3.623	0.500	67	92	13
21695-1933	63	2.625	3.372	0.375	67	86	10	21168-1947	63	2.625	3.623	0.500	67	92	13

All dimensions are in inches. Preferred sizes are indicated with **bold** type face.

Sizes listed are for standard nitrile elements, except Models 25 and 62 which have PTFE elements. Other material available on inquiry only.

## Oil Seals by Model Number

Product Code	Model	Inches			MM			Product Code	Model	Inches			MM		
		ID	OD	Width	ID	OD	Width			ID	OD	Width	ID	OD	Width
25003-1958	23	2.625	3.625	0.375	67	92	10	24802-2635	EQUAL	2.656	4.003	0.625	67	102	16
29609-1916	GD	2.625	3.625	0.375	67	92	10	24600-1565	26	2.662	3.071	0.394	68	78	10
24602-1842	26	2.625	3.625	0.437	67	92	11	24060-2451	61	2.675	3.350	0.375	68	85	10
24060-1842	61	2.625	3.625	0.437	67	92	11	24610-6083	26	2.675	3.675	0.500	68	93	13
24626-1842	26	2.625	3.625	0.438	67	92	11	29507-4484	IG	2.676	3.362	0.625	68	85	16
24600-1842	26	2.625	3.625	0.438	67	92	11	24125-0735	61	2.677	3.543	0.394	68	90	10
24610-1842	26	2.625	3.625	0.438	67	92	11	24801-1984	EQUAL	2.677	3.543	0.500	68	90	13
25003-1844	23	2.625	3.625	0.500	67	92	13	29502-6476	IG	2.677	3.740	0.750	68	95	19
25006-1844	23	2.625	3.625	0.500	67	92	13	29502-5773	IG	2.677	4.000	0.750	68	102	19
24610-1844	26	2.625	3.625	0.500	67	92	13	24802-3023	EQUAL	2.677	3.543	0.625	68	90	16
29519-1841	IG	2.625	3.625	0.625	67	92	16	29502-4541	IG	2.685	3.998	0.750	68	102	19
24801-1841	EQUAL	2.625	3.625	0.625	67	92	16	24060-2920	61	2.687	3.375	0.375	68	86	10
24802-1841	EQUAL	2.625	3.625	0.625	67	92	16	21158-1990	63	2.687	3.481	0.375	68	88	10
23547-5483	63R1	2.625	3.625	0.688	67	92	17	23548-9040	63R2	2.687	3.623	0.687	68	92	17
23548-5483	63R2	2.625	3.625	0.688	67	92	17	24610-0647	26	2.687	3.687	0.500	68	94	13
29602-4151	GD	2.625	3.625	0.700	67	92	18	24610-6282	26	2.687	3.751	0.468	68	95	12
29500-4151	IG	2.625	3.625	0.750	67	92	19	23078-8679	63F1	2.687	3.751	0.594	68	95	15
29502-4151	IG	2.625	3.625	0.750	67	92	19	24600-1987	26	2.688	3.372	0.375	68	86	10
29503-4151	IG	2.625	3.625	0.750	67	92	19	21159-1987	63	2.688	3.372	0.375	68	86	10
29520-4151	IG	2.625	3.625	0.750	67	92	19	21158-1987	63	2.688	3.372	0.375	68	86	10
29522-4151	IG	2.625	3.625	0.750	67	92	19	21168-1987	63	2.688	3.372	0.375	68	86	10
24801-2014	EQUAL	2.625	3.628	0.625	67	92	16	21919-1987	63	2.688	3.372	0.375	68	86	10
29502-5080	IG	2.625	3.670	0.750	67	93	19	24824-2888	EQUAL	2.688	3.438	0.625	68	87	16
29502-4179	IG	2.625	3.675	0.750	67	93	19	21767-1993	62	2.688	3.500	0.375	68	89	10
24802-1086	EQUAL	2.625	3.677	0.625	67	93	16	21702-1993	62	2.688	3.500	0.375	68	89	10
29602-4125	GD	2.625	3.677	0.700	67	93	18	21158-1993	63	2.688	3.500	0.375	68	89	10
29502-4125	IG	2.625	3.677	0.750	67	93	19	21177-1993	63	2.688	3.500	0.375	68	89	10
24802-3650	EQUAL	2.625	3.683	0.625	67	94	16	21695-1993	63	2.688	3.500	0.375	68	89	10
24802-1087	EQUAL	2.625	3.688	0.625	67	94	16	23078-6244	63F1	2.688	3.500	0.594	68	89	15
29502-4126	IG	2.625	3.688	0.750	67	94	19	29519-2003	IG	2.688	3.500	0.625	68	89	16
21795-1948	63	2.625	3.750	0.375	67	95	10	24802-2003	EQUAL	2.688	3.500	0.625	68	89	16
24610-1957	26	2.625	3.750	0.400	67	95	10	29620-6732	GD	2.688	3.500	0.700	68	89	18
24600-1950	26	2.625	3.750	0.500	67	95	13	29520-6732	IG	2.688	3.500	0.750	68	89	19
24612-1950	26	2.625	3.750	0.500	67	95	13	29598-0003	IG	2.688	3.563	0.976	68	91	25
24801-1950	EQUAL	2.625	3.750	0.500	67	95	13	29516-7094	IG	2.688	3.563	0.995	68	91	25
25004-1163	23	2.625	3.750	0.625	67	95	16	29616-7094	GD	2.688	3.563	1.265	68	91	32
24802-1162	EQUAL	2.625	3.750	0.625	67	95	16	24816-7021	EQUAL	2.688	3.574	1.062	68	91	27
29602-5772	GD	2.625	3.750	0.700	67	95	18	24839-7021	EQUAL	2.688	3.574	1.062	68	91	27
29500-5772	IG	2.625	3.750	0.750	67	95	19	21158-1999	63	2.688	3.623	0.375	68	92	10
29502-5772	IG	2.625	3.750	0.750	67	95	19	21158-2001	63	2.688	3.623	0.500	68	92	13
21158-1948	63	2.625	3.751	0.375	67	95	10	24610-3827	26	2.688	3.625	0.500	68	92	13
21695-1948	63	2.625	3.751	0.375	67	95	10	25003-9510	23	2.688	3.688	0.375	68	94	10
21158-1950	63	2.625	3.751	0.500	67	95	13	24802-2736	EQUAL	2.688	3.688	0.625	68	94	16
23548-6651	63R2	2.625	3.751	0.688	67	95	17	24829-2736	EQUAL	2.688	3.688	0.625	68	94	16
21158-1951	63	2.625	3.875	0.375	67	98	10	29502-4282	IG	2.688	3.688	0.750	68	94	19
25064-2102	25	2.625	4.000	0.500	67	102	13	24600-2004	26	2.688	3.750	0.500	68	95	13
29502-5073	IG	2.625	4.000	0.750	67	102	19	21158-2002	63	2.688	3.751	0.375	68	95	10
21158-1954	63	2.625	4.003	0.375	67	102	10	24060-2003	61	2.688	3.751	0.438	68	95	11
21158-1956	63	2.625	4.003	0.500	67	102	13	21290-2003	63	2.688	3.751	0.438	68	95	11
23548-6800	63R2	2.625	4.003	0.688	67	102	17	21158-2003	63	2.688	3.751	0.438	68	95	11
29502-5065	IG	2.625	4.003	0.750	67	102	19	21702-2004	62	2.688	3.751	0.500	68	95	13
29502-5472	IG	2.625	4.050	0.750	67	103	19	21158-2004	63	2.688	3.751	0.500	68	95	13
29502-5815	IG	2.625	5.250	0.750	67	133	19	21695-2004	63	2.688	3.751	0.500	68	95	13
24802-1740	EQUAL	2.628	3.750	0.625	67	95	16	23547-7210	63R1	2.688	3.751	0.688	68	95	17
24802-3514	EQUAL	2.650	3.630	0.625	67	92	16	21158-2005	63	2.688	3.875	0.375	68	98	10
21158-1975	63	2.656	3.751	0.375	67	95	10	24600-1848	26	2.688	3.875	0.468	68	98	12

All dimensions are in inches. Preferred sizes are indicated with **bold** type face.  
 Sizes listed are for standard nitrile elements, except Models 25 and 62 which have PTFE elements. Other material available on inquiry only.

## Oil Seals by Model Number

Product Code	Model	Inches			MM			Product Code	Model	Inches			MM		
		ID	OD	Width	ID	OD	Width			ID	OD	Width	ID	OD	Width
21158-2007	63	2.688	3.875	0.500	68	98	13	21159-2035	63	2.750	3.500	0.375	70	89	10
25003-2013	23	2.688	3.881	0.469	68	99	12	21300-2035	63	2.750	3.500	0.375	70	89	10
24801-6438	EQUAL	2.688	4.000	0.625	68	102	16	21158-2035	63	2.750	3.500	0.375	70	89	10
29502-6111	IG	2.688	4.000	0.750	68	102	19	21542-2035	63	2.750	3.500	0.375	70	89	10
21159-2008	63	2.688	4.003	0.375	68	102	10	21795-2035	63	2.750	3.500	0.375	70	89	10
21158-2008	63	2.688	4.003	0.375	68	102	10	21695-2035	63	2.750	3.500	0.375	70	89	10
21695-2008	63	2.688	4.003	0.375	68	102	10	21527-2035	66	2.750	3.500	0.375	70	89	10
29502-5990	IG	2.700	3.700	0.750	69	94	19	21518-2035	66	2.750	3.500	0.375	70	89	10
29502-4818	IG	2.710	3.710	0.750	69	94	19	21528-2035	67	2.750	3.500	0.375	70	89	10
24802-2010	EQUAL	2.717	3.752	0.625	69	95	16	21823-2035	68	2.750	3.500	0.375	70	89	10
29502-5404	IG	2.718	3.700	0.750	69	94	19	29609-2035	GD	2.750	3.500	0.375	70	89	10
21158-2011	63	2.719	3.481	0.375	69	88	10	21158-2036	63	2.750	3.500	0.438	70	89	11
21158-2014	63	2.719	3.500	0.375	69	89	10	24620-2037	26R1	2.750	3.500	0.500	70	89	13
21158-2017	63	2.719	3.543	0.375	69	90	10	24600-2037	26	2.750	3.500	0.500	70	89	13
21158-2023	63	2.719	3.751	0.375	69	95	10	24063-2037	61	2.750	3.500	0.500	70	89	13
21158-2028	63	2.719	3.875	0.500	69	98	13	24060-2037	61	2.750	3.500	0.500	70	89	13
21158-2031	63	2.719	4.003	0.500	69	102	13	21159-2037	63	2.750	3.500	0.500	70	89	13
29502-5420	IG	2.726	3.500	0.750	69	89	19	21158-2037	63	2.750	3.500	0.500	70	89	13
24802-4469	EQUAL	2.726	3.726	0.625	69	95	16	21527-2037	66	2.750	3.500	0.500	70	89	13
24627-6480	26	2.735	3.485	0.375	69	89	10	24801-2037	EQUAL	2.750	3.500	0.500	70	89	13
29502-6516	IG	2.735	3.500	0.750	69	89	19	24803-2037	EQUAL	2.750	3.500	0.500	70	89	13
29507-7525	IG	2.738	3.738	0.625	70	95	16	23078-7829	63F1	2.750	3.500	0.594	70	89	15
29502-5998	IG	2.740	3.740	0.750	70	95	19	23503-0936	63G1	2.750	3.500	0.625	70	89	16
29502-1254	IG	2.740	4.000	0.750	70	102	19	29507-1238	IG	2.750	3.500	0.625	70	89	16
29520-1254	IG	2.740	4.000	0.750	70	102	19	29519-1238	IG	2.750	3.500	0.625	70	89	16
29507-5014	IG	2.746	3.746	0.625	70	95	16	29607-1238	GD	2.750	3.500	0.625	70	89	16
29502-4589	IG	2.746	3.746	0.750	70	95	19	24802-1238	EQUAL	2.750	3.500	0.625	70	89	16
29602-7385	GD	2.747	3.782	0.700	70	96	18	23548-6716	63R2	2.750	3.500	0.688	70	89	17
24824-2069	EQUAL	2.748	4.250	0.625	70	108	16	24807-3779	EQUAL	2.750	3.500	0.690	70	89	18
26001-7093	71	2.750	3.125	0.109	70	79	3	29602-4187	GD	2.750	3.500	0.700	70	89	18
26001-6304	71	2.750	3.125	0.188	70	79	5	29500-4187	IG	2.750	3.500	0.750	70	89	19
29507-4793	IG	2.750	3.250	0.625	70	83	16	29502-4187	IG	2.750	3.500	0.750	70	89	19
29507-6209	IG	2.750	3.370	0.625	70	86	16	29602-7421	GD	2.750	3.510	0.700	70	89	18
24060-1553	61	2.750	3.375	0.312	70	86	8	21702-2038	62	2.750	3.543	0.375	70	90	10
24125-1553	61	2.750	3.375	0.312	70	86	8	21158-2038	63	2.750	3.543	0.375	70	90	10
24600-2020	26	2.750	3.375	0.313	70	86	8	21919-2038	63	2.750	3.543	0.375	70	90	10
24626-2020	26	2.750	3.375	0.313	70	86	8	21475-2039	63	2.750	3.543	0.437	70	90	11
21702-2032	62	2.750	3.481	0.375	70	88	10	21158-2039	63	2.750	3.543	0.437	70	90	11
21158-2032	63	2.750	3.481	0.375	70	88	10	24600-2039	26	2.750	3.543	0.438	70	90	11
21177-2032	63	2.750	3.481	0.375	70	88	10	21158-2040	63	2.750	3.543	0.500	70	90	13
21695-2032	63	2.750	3.481	0.375	70	88	10	24801-1041	EQUAL	2.750	3.543	0.500	70	90	13
21527-2032	66	2.750	3.481	0.375	70	88	10	29619-1242	GD	2.750	3.543	0.625	70	90	16
21528-2032	67	2.750	3.481	0.375	70	88	10	24802-1242	EQUAL	2.750	3.543	0.625	70	90	16
25010-2035	23	2.750	3.500	0.375	70	89	10	24807-2830	EQUAL	2.750	3.560	0.690	70	90	18
25003-2035	23	2.750	3.500	0.375	70	89	10	21702-2041	62	2.750	3.623	0.375	70	92	10
25006-2035	23	2.750	3.500	0.375	70	89	10	21290-2041	63	2.750	3.623	0.375	70	92	10
25009-2035	23	2.750	3.500	0.375	70	89	10	21158-2041	63	2.750	3.623	0.375	70	92	10
24629-2035	26R1	2.750	3.500	0.375	70	89	10	21527-2041	66	2.750	3.623	0.375	70	92	10
24620-2035	26R1	2.750	3.500	0.375	70	89	10	21528-2041	67	2.750	3.623	0.375	70	92	10
24627-2035	26	2.750	3.500	0.375	70	89	10	24126-2042	61	2.750	3.623	0.438	70	92	11
24600-2035	26	2.750	3.500	0.375	70	89	10	21158-2043	63	2.750	3.623	0.500	70	92	13
24610-2035	26	2.750	3.500	0.375	70	89	10	25138-2054	23	2.750	3.625	0.437	70	92	11
24626-2035	26	2.750	3.500	0.375	70	89	10	25003-2054	23	2.750	3.625	0.438	70	92	11
24060-2035	61	2.750	3.500	0.375	70	89	10	24620-2054	26R1	2.750	3.625	0.438	70	92	11
21702-2035	62	2.750	3.500	0.375	70	89	10	24600-2054	26	2.750	3.625	0.438	70	92	11
21290-2035	63	2.750	3.500	0.375	70	89	10	24801-2264	EQUAL	2.750	3.625	0.625	70	92	16

All dimensions are in inches. Preferred sizes are indicated with **bold** type face.

Sizes listed are for standard nitrile elements, except Models 25 and 62 which have PTFE elements. Other material available on inquiry only.



## Oil Seals by Model Number

Product Code	Model	Inches			MM			Product Code	Model	Inches			MM		
		ID	OD	Width	ID	OD	Width			ID	OD	Width	ID	OD	Width
24802-2264	EQUAL	2.750	3.625	0.625	70	92	16	21158-7934	63	2.750	3.938	0.375	70	100	10
24833-2264	EQUAL	2.750	3.625	0.625	70	92	16	25003-2030	23	2.750	4.000	0.500	70	102	13
29502-4708	IG	2.750	3.625	0.750	70	92	19	24610-0902	26	2.750	4.000	0.500	70	102	13
24610-5358	26	2.750	3.687	0.500	70	94	13	29519-2957	IG	2.750	4.000	0.625	70	102	16
29500-5005	IG	2.750	3.720	0.750	70	94	19	24802-2957	EQUAL	2.750	4.000	0.625	70	102	16
29502-5005	IG	2.750	3.720	0.750	70	94	19	29502-4706	IG	2.750	4.000	0.750	70	102	19
29520-5005	IG	2.750	3.720	0.750	70	94	19	21158-2050	63	2.750	4.003	0.375	70	102	10
25003-2057	23	2.750	3.750	0.375	70	95	10	21528-2050	67	2.750	4.003	0.375	70	102	10
24610-2057	26	2.750	3.750	0.375	70	95	10	24600-2065	26	2.750	4.003	0.469	70	102	12
24600-2058	26	2.750	3.750	0.438	70	95	11	23500-2052	63G1	2.750	4.003	0.500	70	102	13
24821-2058	EQUAL	2.750	3.750	0.438	70	95	11	21158-2052	63	2.750	4.003	0.500	70	102	13
25003-6471	23	2.750	3.750	0.500	70	95	13	24600-2068	26	2.750	4.125	0.438	70	105	11
25058-6471	25	2.750	3.750	0.500	70	95	13	24802-2634	EQUAL	2.750	4.125	0.625	70	105	16
24627-6471	26	2.750	3.750	0.500	70	95	13	29502-6308	IG	2.750	4.250	0.750	70	108	19
24600-6471	26	2.750	3.750	0.500	70	95	13	29516-7173	IG	2.750	4.370	0.722	70	111	18
24610-6471	26	2.750	3.750	0.500	70	95	13	24802-3174	EQUAL	2.750	4.375	0.625	70	111	16
24612-6471	26	2.750	3.750	0.500	70	95	13	24600-2021	26	2.750	4.625	0.625	70	117	16
21168-2046	63	2.750	3.750	0.500	70	95	13	24610-6101	26	2.750	4.750	0.500	70	121	13
24802-1250	EQUAL	2.750	3.750	0.625	70	95	16	29520-6453	IG	2.750	4.750	0.750	70	121	19
24832-1250	EQUAL	2.750	3.750	0.625	70	95	16	21140-6005	54	2.750	6.000	0.625	70	152	16
29602-4152	GD	2.750	3.750	0.700	70	95	18	24620-2058	26R1	2.751	3.750	0.438	70	95	11
29500-4152	IG	2.750	3.750	0.750	70	95	19	25003-4765	23	2.755	3.543	0.375	70	90	10
29502-4152	IG	2.750	3.750	0.750	70	95	19	25004-4765	23	2.755	3.543	0.375	70	90	10
25003-2044	23	2.750	3.751	0.375	70	95	10	29507-3107	IG	2.755	3.741	0.625	70	95	16
25006-2044	23	2.750	3.751	0.375	70	95	10	24802-3107	EQUAL	2.755	3.741	0.625	70	95	16
21702-2044	62	2.750	3.751	0.375	70	95	10	24802-1810	EQUAL	2.755	3.750	0.625	70	95	16
21160-2044	63	2.750	3.751	0.375	70	95	10	24802-3012	EQUAL	2.755	3.755	0.625	70	95	16
21158-2044	63	2.750	3.751	0.375	70	95	10	24801-2250	EQUAL	2.755	3.937	0.625	70	100	16
21695-2044	63	2.750	3.751	0.375	70	95	10	24620-2026	26R1	2.756	3.346	0.315	70	85	8
21527-2044	66	2.750	3.751	0.375	70	95	10	24622-4259	26R1	2.756	3.346	0.354	70	85	9
21158-2045	63	2.750	3.751	0.437	70	95	11	24610-2070	26	2.756	3.543	0.394	70	90	10
24062-2046	61	2.750	3.751	0.500	70	95	13	24602-2070	26	2.756	3.543	0.394	70	90	10
21702-2046	62	2.750	3.751	0.500	70	95	13	24063-3625	61	2.756	3.543	0.437	70	90	11
21158-2046	63	2.750	3.751	0.500	70	95	13	24062-3625	61	2.756	3.543	0.437	70	90	11
24600-2033	26	2.750	3.751	0.687	70	95	17	24060-2814	61	2.756	3.543	0.472	70	90	12
23547-6467	63R1	2.750	3.751	0.687	70	95	17	24627-5720	26	2.756	3.543	0.512	70	90	13
23548-6467	63R2	2.750	3.751	0.688	70	95	17	24620-2027	26R1	2.756	3.622	0.472	70	92	12
23627-6467	63R2	2.750	3.751	0.688	70	95	17	24125-0759	61	2.756	3.937	0.394	70	100	10
24801-1147	EQUAL	2.750	3.755	0.500	70	95	13	29507-6135	IG	2.756	3.346	0.625	70	85	16
29502-6003	IG	2.750	3.755	0.750	70	95	19	29507-6513	IG	2.756	3.500	0.625	70	89	16
24816-7042	EQUAL	2.750	3.772	1.000	70	96	25	29602-6740	GD	2.756	3.513	0.700	70	89	18
29521-6108	IG	2.750	3.813	0.875	70	97	22	24600-2071	26	2.756	3.543	0.237	70	90	6
21158-2047	63	2.750	3.875	0.375	70	98	10	24626-2070	26	2.756	3.543	0.394	70	90	10
21695-2047	63	2.750	3.875	0.375	70	98	10	24600-2070	26	2.756	3.543	0.394	70	90	10
24612-0901	26	2.750	3.875	0.500	70	98	13	24060-2038	61	2.756	3.543	0.394	70	90	10
21702-2049	62	2.750	3.875	0.500	70	98	13	24063-2814	61	2.756	3.543	0.472	70	90	12
21158-2049	63	2.750	3.875	0.500	70	98	13	24801-2067	EQUAL	2.756	3.543	0.500	70	90	13
24801-0901	EQUAL	2.750	3.875	0.500	70	98	13	24610-5720	26	2.756	3.543	0.511	70	90	13
25004-2049	23	2.750	3.875	0.625	70	98	16	29507-2059	IG	2.756	3.543	0.625	70	90	16
24801-2062	EQUAL	2.750	3.875	0.625	70	98	16	29519-2059	IG	2.756	3.543	0.625	70	90	16
24802-2062	EQUAL	2.750	3.875	0.625	70	98	16	24801-2919	EQUAL	2.756	3.543	0.625	70	90	16
29502-2063	IG	2.750	3.875	0.750	70	98	19	24802-2059	EQUAL	2.756	3.543	0.625	70	90	16
29521-5805	IG	2.750	3.875	0.875	70	98	22	29602-4969	GD	2.756	3.543	0.700	70	90	18
21158-2048	63	2.750	3.876	0.438	70	98	11	29500-4969	IG	2.756	3.543	0.750	70	90	19
24622-2066	26R1	2.750	3.876	0.468	70	98	12	29502-4969	IG	2.756	3.543	0.750	70	90	19
21159-7934	63	2.750	3.938	0.375	70	100	10	29520-4969	IG	2.756	3.543	0.750	70	90	19

All dimensions are in inches. Preferred sizes are indicated with **bold** type face.  
 Sizes listed are for standard nitrile elements, except Models 25 and 62 which have PTFE elements. Other material available on inquiry only.

## Oil Seals by Model Number

Product Code	Model	Inches			MM			Product Code	Model	Inches			MM		
		ID	OD	Width	ID	OD	Width			ID	OD	Width	ID	OD	Width
24622-4261	26R1	2.756	3.544	0.433	70	90	11	21695-2077	63	2.813	3.500	0.375	71	89	10
24801-2078	EQUAL	2.756	3.622	0.500	70	92	13	29507-6929	IG	2.813	3.500	0.625	71	89	16
24802-5095	EQUAL	2.756	3.622	0.625	70	92	16	29516-7085	IG	2.813	3.563	0.956	71	91	24
29502-6415	IG	2.756	3.622	0.750	70	92	19	24816-7032	EQUAL	2.813	3.569	1.375	71	91	35
29602-6775	GD	2.756	3.625	0.700	70	92	18	24802-1982	EQUAL	2.813	3.580	0.625	71	91	16
21003-4392	58	2.756	3.740	0.472	70	95	12	21158-2083	63	2.813	3.623	0.375	71	92	10
29602-4192	GD	2.756	3.740	0.700	70	95	18	21158-2085	63	2.813	3.623	0.500	71	92	13
29500-4192	IG	2.756	3.740	0.750	70	95	19	21158-2086	63	2.813	3.751	0.375	71	95	10
29502-4192	IG	2.756	3.740	0.750	70	95	19	21695-2086	63	2.813	3.751	0.375	71	95	10
29502-5970	IG	2.756	3.780	0.750	70	96	19	24060-2526	61	2.813	3.751	0.438	71	95	11
29519-6488	IG	2.756	3.917	0.625	70	99	16	21158-2088	63	2.813	3.751	0.500	71	95	13
24063-4574	61	2.756	3.937	0.437	70	100	11	24801-2676	EQUAL	2.813	3.751	0.625	71	95	16
24801-2087	EQUAL	2.756	3.938	0.500	70	100	13	23548-7159	63R2	2.813	3.751	0.688	71	95	17
24802-2250	EQUAL	2.756	3.938	0.625	70	100	16	29502-5979	IG	2.813	3.751	0.750	71	95	19
29500-6138	IG	2.756	3.976	0.750	70	101	19	21158-2089	63	2.813	3.875	0.375	71	98	10
29516-7177	IG	2.756	3.976	0.765	70	101	19	21695-2089	63	2.813	3.875	0.375	71	98	10
24626-5598	26	2.756	4.015	0.500	70	102	13	21158-2090	63	2.813	3.875	0.437	71	98	11
24600-5598	26	2.756	4.015	0.500	70	102	13	24802-6505	EQUAL	2.813	4.000	0.625	71	102	16
29502-6819	IG	2.756	4.134	0.750	70	105	19	21158-2093	63	2.813	4.003	0.437	71	102	11
24626-2274	26	2.756	4.331	0.500	70	110	13	29502-5329	IG	2.819	3.813	0.750	72	97	19
24600-2274	26	2.756	4.331	0.500	70	110	13	29502-7301	IG	2.819	3.828	0.750	72	97	19
24062-4875	61	2.756	4.331	0.512	70	110	13	29505-6084	IG	2.820	3.820	0.500	72	97	13
24802-3989	EQUAL	2.756	4.331	0.625	70	110	16	29502-5958	IG	2.820	3.837	0.750	72	97	19
24809-3989	EQUAL	2.756	4.331	0.625	70	110	16	29519-6310	IG	2.820	3.843	0.625	72	98	16
24829-5458	EQUAL	2.756	4.921	0.625	70	125	16	29502-5396	IG	2.820	3.843	0.750	72	98	19
29500-7467	IG	2.756	4.921	0.750	70	125	19	29502-6884	IG	2.820	3.850	0.750	72	98	19
29502-7260	IG	2.756	5.512	0.750	70	140	19	29502-6191	IG	2.825	3.815	0.750	72	97	19
29502-6197	IG	2.760	4.000	0.750	70	102	19	25003-1039	23	2.835	3.740	0.375	72	95	10
24610-6352	26	2.762	3.700	0.500	70	94	13	29502-4971	IG	2.835	3.740	0.750	72	95	19
29602-5611	GD	2.770	3.770	0.700	70	96	18	29602-4972	GD	2.835	3.937	0.700	72	100	18
29502-5611	IG	2.770	3.770	0.750	70	96	19	29519-6311	IG	2.843	3.937	0.625	72	100	16
29502-5647	IG	2.775	3.775	0.750	70	96	19	21158-2098	63	2.844	3.623	0.375	72	92	10
29507-6143	IG	2.780	3.250	0.625	71	83	16	21702-2101	62	2.844	3.751	0.375	72	95	10
24626-0845	26	2.781	3.500	0.375	71	89	10	21158-2103	63	2.844	3.751	0.500	72	95	13
24600-0845	26	2.781	3.500	0.375	71	89	10	21158-7937	63	2.844	3.938	0.375	72	100	10
24824-5009	EQUAL	2.781	3.593	0.625	71	91	16	25003-0128	23	2.857	3.857	0.375	73	98	10
29516-7180	IG	2.787	3.366	0.765	71	85	19	23501-6627	63G1	2.863	4.724	0.500	73	120	13
24600-2077	26	2.795	3.465	0.472	71	88	12	21159-6627	63	2.863	4.724	0.500	73	120	13
21158-2080	63	2.812	3.543	0.375	71	90	10	21158-6627	63	2.863	4.724	0.500	73	120	13
25003-0806	23	2.812	3.560	0.375	71	90	10	21168-6627	63	2.863	4.724	0.500	73	120	13
29602-1510	GD	2.812	3.750	0.700	71	95	18	29500-6158	IG	2.863	4.724	0.750	73	120	19
29620-1510	GD	2.812	3.750	0.700	71	95	18	29602-6953	GD	2.873	3.873	0.700	73	98	18
24610-0648	26	2.812	3.812	0.500	71	97	13	24060-2508	61	2.874	3.543	0.393	73	90	10
29602-4283	GD	2.812	3.812	0.700	71	97	18	29507-6122	IG	2.874	3.583	0.625	73	91	16
29502-4283	IG	2.812	3.812	0.750	71	97	19	29507-5062	IG	2.875	3.375	0.625	73	86	16
29522-4283	IG	2.812	3.812	0.750	71	97	19	24600-2114	26	2.875	3.500	0.313	73	89	8
21158-2091	63	2.812	3.876	0.500	71	98	13	29507-4564	IG	2.875	3.500	0.625	73	89	16
29500-4834	IG	2.812	4.002	0.750	71	102	19	24602-2102	26	2.875	3.563	0.309	73	91	8
21158-2094	63	2.812	4.003	0.500	71	102	13	29516-7077	IG	2.875	3.563	1.102	73	91	28
23078-9070	63F1	2.812	4.003	0.594	71	102	15	25003-2115	23	2.875	3.623	0.375	73	92	10
21702-2077	62	2.813	3.500	0.375	71	89	10	21290-2115	63	2.875	3.623	0.375	73	92	10
21159-2077	63	2.813	3.500	0.375	71	89	10	21158-2115	63	2.875	3.623	0.375	73	92	10
21793-2077	63	2.813	3.500	0.375	71	89	10	21168-2115	63	2.875	3.623	0.375	73	92	10
21158-2077	63	2.813	3.500	0.375	71	89	10	21695-2115	63	2.875	3.623	0.375	73	92	10
21506-2077	63	2.813	3.500	0.375	71	89	10	21158-2116	63	2.875	3.623	0.437	73	92	11
21805-2077	63	2.813	3.500	0.375	71	89	10	23501-2117	63G1	2.875	3.623	0.500	73	92	13

All dimensions are in inches. Preferred sizes are indicated with **bold** type face.

Sizes listed are for standard nitrile elements, except Models 25 and 62 which have PTFE elements. Other material available on inquiry only.

## Oil Seals by Model Number

Product Code	Model	Inches			MM			Product Code	Model	Inches			MM		
		ID	OD	Width	ID	OD	Width			ID	OD	Width	ID	OD	Width
21158-2117	63	2.875	3.623	0.500	73	92	13	24600-2113	26	2.875	4.000	0.469	73	102	12
25003-2110	23	2.875	3.625	0.375	73	92	10	24060-1560	61	2.875	4.000	0.500	73	102	13
24801-2086	EQUAL	2.875	3.625	0.625	73	92	16	24802-2843	EQUAL	2.875	4.000	0.625	73	102	16
24802-2086	EQUAL	2.875	3.625	0.625	73	92	16	29602-4331	GD	2.875	4.000	0.700	73	102	18
29602-4548	GD	2.875	3.625	0.700	73	92	18	29500-4331	IG	2.875	4.000	0.750	73	102	19
29502-4548	IG	2.875	3.625	0.750	73	92	19	29502-4331	IG	2.875	4.000	0.750	73	102	19
25003-2118	23	2.875	3.750	0.375	73	95	10	29520-4331	IG	2.875	4.000	0.750	73	102	19
25006-2118	23	2.875	3.750	0.375	73	95	10	21159-2124	63	2.875	4.003	0.375	73	102	10
25004-2118	23	2.875	3.750	0.375	73	95	10	21158-2124	63	2.875	4.003	0.375	73	102	10
25009-2118	23	2.875	3.750	0.375	73	95	10	21695-2124	63	2.875	4.003	0.375	73	102	10
25284-2118	23	2.875	3.750	0.375	73	95	10	21158-2126	63	2.875	4.003	0.500	73	102	13
21163-2118	63	2.875	3.750	0.375	73	95	10	24801-1205	EQUAL	2.875	4.003	0.625	73	102	16
21695-2118	63	2.875	3.750	0.375	73	95	10	24802-1205	EQUAL	2.875	4.003	0.625	73	102	16
25270-2701	23	2.875	3.750	0.395	73	95	10	23548-6599	63R2	2.875	4.003	0.688	73	102	17
25284-2701	23	2.875	3.750	0.395	73	95	10	23550-6599	63T2	2.875	4.003	0.688	73	102	17
24801-1081	EQUAL	2.875	3.750	0.625	73	95	16	29602-6948	GD	2.875	4.003	0.700	73	102	18
24802-1081	EQUAL	2.875	3.750	0.625	73	95	16	21158-2127	63	2.875	4.125	0.406	73	105	10
24803-1081	EQUAL	2.875	3.750	0.625	73	95	16	21158-2128	63	2.875	4.125	0.469	73	105	12
29602-4479	GD	2.875	3.750	0.700	73	95	18	25003-5127	23	2.875	4.125	0.500	73	105	13
29502-4479	IG	2.875	3.750	0.750	73	95	19	29518-5710	IG	2.875	4.125	0.875	73	105	22
24620-4021	26R1	2.875	3.751	0.250	73	95	6	29500-4694	IG	2.875	4.134	0.750	73	105	19
24610-2118	26	2.875	3.751	0.375	73	95	10	29602-5312	GD	2.875	4.250	0.700	73	108	18
24060-2118	61	2.875	3.751	0.375	73	95	10	29500-5312	IG	2.875	4.250	0.750	73	108	19
21702-2118	62	2.875	3.751	0.375	73	95	10	29502-5312	IG	2.875	4.250	0.750	73	108	19
21158-2118	63	2.875	3.751	0.375	73	95	10	24802-5069	EQUAL	2.875	4.375	0.625	73	111	16
21164-2118	63	2.875	3.751	0.375	73	95	10	24802-1878	EQUAL	2.875	4.380	0.625	73	111	16
21919-2118	63	2.875	3.751	0.375	73	95	10	24802-3093	EQUAL	2.875	4.625	0.625	73	117	16
24600-2120	26	2.875	3.751	0.500	73	95	13	29602-4386	GD	2.875	4.625	0.700	73	117	18
21702-2120	62	2.875	3.751	0.500	73	95	13	29502-4386	IG	2.875	4.625	0.750	73	117	19
21158-2120	63	2.875	3.751	0.500	73	95	13	24060-2059	61	2.880	3.625	0.375	73	92	10
21163-2120	63	2.875	3.751	0.500	73	95	13	25003-0993	23	2.883	3.633	0.375	73	92	10
21695-2120	63	2.875	3.751	0.500	73	95	13	24802-3137	EQUAL	2.900	3.900	0.625	74	99	16
23547-6730	63R1	2.875	3.751	0.688	73	95	17	24600-2137	26	2.901	3.601	0.232	74	91	6
23548-6730	63R2	2.875	3.751	0.688	73	95	17	25003-4855	23	2.906	3.906	0.375	74	99	10
23550-6730	63T2	2.875	3.751	0.688	73	95	17	21158-2138	63	2.906	4.003	0.375	74	102	10
25003-2121	23	2.875	3.875	0.375	73	98	10	21158-2141	63	2.906	4.125	0.406	74	105	10
24626-2121	26	2.875	3.875	0.375	73	98	10	24821-5147	EQUAL	2.913	3.937	0.625	74	100	16
24627-2121	26	2.875	3.875	0.375	73	98	10	24610-6082	26	2.925	3.925	0.500	74	100	13
24600-2121	26	2.875	3.875	0.375	73	98	10	29502-5469	IG	2.925	3.925	0.750	74	100	19
24610-2121	26	2.875	3.875	0.375	73	98	10	24610-6080	26	2.925	4.000	0.375	74	102	10
21158-2121	63	2.875	3.875	0.375	73	98	10	29502-5943	IG	2.930	3.930	0.750	74	100	19
21158-2122	63	2.875	3.875	0.437	73	98	11	24802-3493	EQUAL	2.932	3.806	0.625	74	97	16
24627-0649	26	2.875	3.875	0.500	73	98	13	24807-3504	EQUAL	2.932	3.806	0.690	74	97	18
24060-2123	61	2.875	3.875	0.500	73	98	13	24802-3513	EQUAL	2.932	3.932	0.625	74	100	16
21158-2123	63	2.875	3.875	0.500	73	98	13	29607-6696	GD	2.933	3.498	0.625	74	89	16
24801-1268	EQUAL	2.875	3.875	0.625	73	98	16	24802-3086	EQUAL	2.933	3.750	0.625	74	95	16
24802-1268	EQUAL	2.875	3.875	0.625	73	98	16	29502-6851	IG	2.933	4.126	0.750	74	105	19
29602-4153	GD	2.875	3.875	0.700	73	98	18	24610-3847	26	2.937	3.687	0.375	75	94	10
29610-4153	GD	2.875	3.875	0.700	73	98	18	24822-1980	EQUAL	2.937	3.750	0.625	75	95	16
29502-4153	IG	2.875	3.875	0.750	73	98	19	24060-2148	61	2.937	3.751	0.500	75	95	13
29520-4153	IG	2.875	3.875	0.750	73	98	19	21158-2148	63	2.937	3.751	0.500	75	95	13
29529-4153	IG	2.875	3.875	0.750	73	98	19	21158-2151	63	2.937	3.876	0.500	75	98	13
23548-1171	63R2	2.875	3.876	0.688	73	98	17	24060-7596	61	2.937	3.937	0.375	75	100	10
21158-7938	63	2.875	3.938	0.375	73	100	10	25284-2140	23	2.937	3.937	0.500	75	100	13
24627-3643	26	2.875	4.000	0.438	73	102	11	24060-2140	61	2.937	3.937	0.500	75	100	13
24610-3643	26	2.875	4.000	0.438	73	102	11	21160-9481	63	2.937	4.125	0.562	75	105	14

All dimensions are in inches. Preferred sizes are indicated with **bold** type face. Sizes listed are for standard nitrile elements, except Models 25 and 62 which have PTFE elements. Other material available on inquiry only.

## Oil Seals by Model Number

Product Code	Model	Inches			MM			Product Code	Model	Inches			MM		
		ID	OD	Width	ID	OD	Width			ID	OD	Width	ID	OD	Width
23550-7722	63T2	2.937	4.125	0.719	75	105	18	24802-2083	EQUAL	2.938	3.938	0.625	75	100	16
29507-6437	IG	2.938	3.375	0.625	75	86	16	24827-2083	EQUAL	2.938	3.938	0.625	75	100	16
29507-5153	IG	2.938	3.544	0.625	75	90	16	24854-2083	EQUAL	2.938	3.938	0.625	75	100	16
21159-2143	63	2.938	3.623	0.375	75	92	10	29602-4284	GD	2.938	3.938	0.700	75	100	18
21158-2143	63	2.938	3.623	0.375	75	92	10	29500-4284	IG	2.938	3.938	0.750	75	100	19
21158-2145	63	2.938	3.623	0.500	75	92	13	29502-4284	IG	2.938	3.938	0.750	75	100	19
29507-4522	IG	2.938	3.623	0.625	75	92	16	29522-4284	IG	2.938	3.938	0.750	75	100	19
23548-8863	63R2	2.938	3.623	0.688	75	92	17	29516-7106	IG	2.938	3.940	0.994	75	100	25
24807-2138	EQUAL	2.938	3.623	0.690	75	92	18	24816-7017	EQUAL	2.938	3.956	1.375	75	100	35
24626-2144	26	2.938	3.625	0.375	75	92	10	25003-8385	23	2.938	4.000	0.375	75	102	10
24600-2144	26	2.938	3.625	0.375	75	92	10	25003-0895	23	2.938	4.000	0.500	75	102	13
25003-7833	23	2.938	3.688	0.375	75	94	10	25003-0917	23	2.938	4.000	0.500	75	102	13
25006-7833	23	2.938	3.688	0.375	75	94	10	25006-2167	23	2.938	4.000	0.500	75	102	13
24801-2145	EQUAL	2.938	3.688	0.500	75	94	13	24610-2167	26	2.938	4.000	0.500	75	102	13
24801-1908	EQUAL	2.938	3.688	0.625	75	94	16	24627-2167	26	2.938	4.000	0.500	75	102	13
24822-1908	EQUAL	2.938	3.688	0.625	75	94	16	24801-2167	EQUAL	2.938	4.000	0.500	75	102	13
25010-2146	23	2.938	3.750	0.375	75	95	10	23502-0938	63G1	2.938	4.000	0.625	75	102	16
25003-2146	23	2.938	3.750	0.375	75	95	10	29500-4648	IG	2.938	4.000	0.750	75	102	19
25009-2146	23	2.938	3.750	0.375	75	95	10	29502-4594	IG	2.938	4.000	0.750	75	102	19
24600-2146	26	2.938	3.750	0.375	75	95	10	25003-2152	23	2.938	4.003	0.375	75	102	10
24125-2146	61	2.938	3.750	0.375	75	95	10	25058-2152	25	2.938	4.003	0.375	75	102	10
24060-2146	61	2.938	3.750	0.375	75	95	10	21158-2152	63	2.938	4.003	0.375	75	102	10
21475-2146	63	2.938	3.750	0.375	75	95	10	21500-2152	63	2.938	4.003	0.375	75	102	10
21702-2147	62	2.938	3.750	0.438	75	95	11	25003-2153	23	2.938	4.003	0.437	75	102	11
29519-7302	IG	2.938	3.750	0.625	75	95	16	24060-2153	61	2.938	4.003	0.438	75	102	11
24802-1980	EQUAL	2.938	3.750	0.625	75	95	16	21158-2153	63	2.938	4.003	0.438	75	102	11
29502-4850	IG	2.938	3.750	0.750	75	95	19	21702-2154	62	2.938	4.003	0.500	75	102	13
21702-2146	62	2.938	3.751	0.375	75	95	10	21158-2154	63	2.938	4.003	0.500	75	102	13
21159-2146	63	2.938	3.751	0.375	75	95	10	21168-2154	63	2.938	4.003	0.500	75	102	13
21158-2146	63	2.938	3.751	0.375	75	95	10	24802-0997	EQUAL	2.938	4.003	0.625	75	102	16
21795-2146	63	2.938	3.751	0.375	75	95	10	23547-6588	63R1	2.938	4.003	0.688	75	102	17
21919-2146	63	2.938	3.751	0.375	75	95	10	29502-5127	IG	2.938	4.003	0.750	75	102	19
21695-2146	63	2.938	3.751	0.375	75	95	10	24600-2081	26	2.938	4.008	0.469	75	102	12
23552-1920	63T2	2.938	3.751	0.688	75	95	17	25284-3349	23	2.938	4.063	0.375	75	103	10
24802-1142	EQUAL	2.938	3.813	0.625	75	97	16	29609-6244	GD	2.938	4.125	0.375	75	105	10
29516-7215	IG	2.938	3.813	0.879	75	97	22	21158-2155	63	2.938	4.125	0.406	75	105	10
29516-7095	IG	2.938	3.813	0.995	75	97	25	29502-4544	IG	2.938	4.125	0.750	75	105	19
29616-7095	GD	2.938	3.813	1.265	75	97	32	29516-7115	IG	2.938	4.173	0.814	75	106	21
24816-7022	EQUAL	2.938	3.817	1.062	75	97	27	24850-4691	EQUAL	2.938	4.188	0.625	75	106	16
24839-7022	EQUAL	2.938	3.817	1.062	75	97	27	29502-4838	IG	2.938	4.295	0.750	75	109	19
25003-2149	23	2.938	3.875	0.375	75	98	10	24816-7060	EQUAL	2.938	4.480	1.063	75	114	27
24125-2149	61	2.938	3.875	0.375	75	98	10	29516-7193	IG	2.938	4.485	0.917	75	114	23
21158-2149	63	2.938	3.875	0.375	75	98	10	29502-5413	IG	2.938	4.500	0.750	75	114	19
21695-2149	63	2.938	3.875	0.375	75	98	10	29516-7163	IG	2.938	5.807	0.806	75	147	20
24600-2151	26	2.938	3.875	0.500	75	98	13	29502-4770	IG	2.942	3.942	0.750	75	100	19
29519-5806	IG	2.938	3.875	0.625	75	98	16	25009-2772	23	2.948	4.448	0.375	75	113	10
23547-8470	63R1	2.938	3.875	0.688	75	98	17	29502-5697	IG	2.950	3.950	0.750	75	100	19
25003-4040	23	2.938	3.906	0.375	75	99	10	24802-3519	EQUAL	2.950	3.960	0.625	75	101	16
25003-1256	23	2.938	3.906	0.484	75	99	12	29619-6857	GD	2.950	3.970	0.625	75	101	16
25003-8488	23	2.938	3.906	0.484	75	99	12	29502-5742	IG	2.950	4.000	0.750	75	102	19
25003-7596	23	2.938	3.938	0.375	75	100	10	29503-4849	IG	2.950	4.125	0.750	75	105	19
21158-7596	63	2.938	3.938	0.375	75	100	10	24802-3736	EQUAL	2.950	4.250	0.625	75	108	16
25003-6351	23	2.938	3.938	0.500	75	100	13	24626-0827	26	2.952	3.937	0.511	75	100	13
25004-6351	23	2.938	3.938	0.500	75	100	13	24610-0827	26	2.952	3.938	0.511	75	100	13
25284-6351	23	2.938	3.938	0.500	75	100	13	29602-7287	GD	2.952	3.952	0.700	75	100	18
29519-2083	IG	2.938	3.938	0.625	75	100	16	24802-1811	EQUAL	2.952	4.000	0.625	75	102	16

All dimensions are in inches. Preferred sizes are indicated with **bold** type face.

Sizes listed are for standard nitrile elements, except Models 25 and 62 which have PTFE elements. Other material available on inquiry only.

## Oil Seals by Model Number

Product Code	Model	Inches			MM			Product Code	Model	Inches			MM		
		ID	OD	Width	ID	OD	Width			ID	OD	Width	ID	OD	Width
24622-3663	26R1	2.953	3.740	0.512	75	95	13	24802-3221	EQUAL	2.998	3.998	0.625	76	102	16
24602-2082	26	2.953	3.937	0.394	75	100	10	29602-6680	GD	2.998	3.998	0.700	76	102	18
24600-0827	26	2.953	3.937	0.512	75	100	13	21959-2168	67	3.000	3.375	0.375	76	86	10
24600-2105	26	2.953	4.213	0.492	75	107	13	27023-9574	91	3.000	3.406	0.203	76	87	5
24062-2377	61	2.953	3.543	0.393	75	90	10	26001-6308	71	3.000	3.500	0.250	76	89	6
24610-4050	26	2.953	3.740	0.394	75	95	10	29507-5650	IG	3.000	3.500	0.625	76	89	16
24060-0797	61	2.953	3.740	0.394	75	95	10	24807-2045	EQUAL	3.000	3.500	0.690	76	89	18
24626-3663	26	2.953	3.740	0.511	75	95	13	29507-6142	IG	3.000	3.618	0.625	76	92	16
24600-3663	26	2.953	3.740	0.511	75	95	13	29507-6781	IG	3.000	3.625	0.625	76	92	16
24060-1848	61	2.953	3.740	0.512	75	95	13	29507-6123	IG	3.000	3.740	0.625	76	95	16
29507-3316	IG	2.953	3.740	0.625	75	95	16	25009-2168	23	3.000	3.750	0.375	76	95	10
29519-3316	IG	2.953	3.740	0.625	75	95	16	25058-2168	25	3.000	3.750	0.375	76	95	10
24802-3316	EQUAL	2.953	3.740	0.625	75	95	16	24627-2168	26	3.000	3.750	0.375	76	95	10
24807-3312	EQUAL	2.953	3.740	0.690	75	95	18	24600-2168	26	3.000	3.750	0.375	76	95	10
29500-4822	IG	2.953	3.740	0.750	75	95	19	24610-2168	26	3.000	3.750	0.375	76	95	10
29502-4822	IG	2.953	3.740	0.750	75	95	19	24602-2168	26	3.000	3.750	0.375	76	95	10
29516-7169	IG	2.953	3.813	1.035	75	97	26	24060-2168	61	3.000	3.750	0.375	76	95	10
24060-2966	61	2.953	3.937	0.375	75	100	10	21527-2168	66	3.000	3.750	0.375	76	95	10
24060-0809	61	2.953	3.937	0.394	75	100	10	24063-2169	61	3.000	3.750	0.438	76	95	11
21003-1921	58	2.953	3.937	0.512	75	100	13	24060-2169	61	3.000	3.750	0.438	76	95	11
25003-2966	23	2.953	3.938	0.375	75	100	10	24062-2169	61	3.000	3.750	0.438	76	95	11
24801-1078	EQUAL	2.953	3.938	0.500	75	100	13	24060-2170	61	3.000	3.750	0.500	76	95	13
24638-0827	26	2.953	3.938	.512	75	100	13	24062-2170	61	3.000	3.750	0.500	76	95	13
24801-2166	EQUAL	2.953	3.938	0.625	75	100	16	23078-7542	63F1	3.000	3.750	0.594	76	95	15
24802-2166	EQUAL	2.953	3.938	0.625	75	100	16	29519-1265	IG	3.000	3.750	0.625	76	95	16
29602-4749	GD	2.953	3.938	0.700	75	100	18	29619-4709	GD	3.000	3.750	0.625	76	95	16
29502-4749	IG	2.953	3.938	0.750	75	100	19	24801-1265	EQUAL	3.000	3.750	0.625	76	95	16
25010-4402	23	2.953	3.953	0.375	75	100	10	24802-1265	EQUAL	3.000	3.750	0.625	76	95	16
24813-3543	EQUAL	2.953	3.953	0.625	75	100	16	24822-1265	EQUAL	3.000	3.750	0.625	76	95	16
29520-7275	IG	2.953	3.967	0.760	75	101	19	29602-4709	GD	3.000	3.750	0.700	76	95	18
29516-7152	IG	2.953	3.976	0.696	75	101	18	29500-4709	IG	3.000	3.750	0.750	76	95	19
29602-6664	GD	2.953	3.976	0.700	75	101	18	29502-4709	IG	3.000	3.750	0.750	76	95	19
29502-6664	IG	2.953	3.976	0.750	75	101	19	29520-4709	IG	3.000	3.750	0.750	76	95	19
29516-7219	IG	2.953	4.094	0.948	75	104	24	25010-2168	23	3.000	3.751	0.375	76	95	10
29502-5589	IG	2.953	4.175	0.750	75	106	19	25003-2168	23	3.000	3.751	0.375	76	95	10
25003-2105	23	2.953	4.213	0.492	75	107	12	25006-2168	23	3.000	3.751	0.375	76	95	10
24626-2105	26	2.953	4.213	0.492	75	107	12	25004-2168	23	3.000	3.751	0.375	76	95	10
25003-2331	23	2.953	4.213	0.500	75	107	13	25287-2168	23	3.000	3.751	0.375	76	95	10
29502-5739	IG	2.953	4.331	0.750	75	110	19	24626-2168	26	3.000	3.751	0.375	76	95	10
27223-5074	94	2.953	4.528	0.375	75	115	10	21702-2168	62	3.000	3.751	0.375	76	95	10
24620-2908	26R1	2.953	4.528	0.472	75	115	12	21695-2168	63	3.000	3.751	0.375	76	95	10
29507-5004	IG	2.955	3.500	0.625	75	89	16	21294-2168	63	3.000	3.751	0.375	76	95	10
24063-3033	61	2.960	3.750	0.438	75	95	11	21159-2168	63	3.000	3.751	0.375	76	95	10
21158-2157	63	2.969	3.751	0.375	75	95	10	21475-2168	63	3.000	3.751	0.375	76	95	10
23550-4648	63T2	2.969	3.751	0.688	75	95	17	21158-2168	63	3.000	3.751	0.375	76	95	10
21158-2160	63	2.969	3.875	0.375	75	98	10	21177-2168	63	3.000	3.751	0.375	76	95	10
21158-2163	63	2.969	4.003	0.375	75	102	10	21168-2168	63	3.000	3.751	0.375	76	95	10
21158-2166	63	2.969	4.125	0.406	75	105	10	21528-2168	67	3.000	3.751	0.375	76	95	10
29507-7524	IG	2.987	3.987	0.625	76	101	16	21823-2168	68	3.000	3.751	0.375	76	95	10
29502-4457	IG	2.990	3.750	0.750	76	95	19	21158-2169	63	3.000	3.751	0.438	76	95	11
29500-4675	IG	2.990	4.000	0.750	76	102	19	24063-2170	61	3.000	3.751	0.500	76	95	13
29502-4675	IG	2.990	4.000	0.750	76	102	19	23502-2170	63G1	3.000	3.751	0.500	76	95	13
29502-6750	IG	2.992	3.858	0.750	76	98	19	21158-2170	63	3.000	3.751	0.500	76	95	13
29602-6672	GD	2.995	4.000	0.700	76	102	18	21920-2170	66	3.000	3.751	0.500	76	95	13
29502-4658	IG	2.997	3.831	0.750	76	97	19	21527-2170	66	3.000	3.751	0.500	76	95	13
24807-2165	EQUAL	2.998	3.515	0.690	76	89	18	23548-6543	63R2	3.000	3.751	0.688	76	95	17

All dimensions are in inches. Preferred sizes are indicated with **bold** type face. Sizes listed are for standard nitrile elements, except Models 25 and 62 which have PTFE elements. Other material available on inquiry only.

## Oil Seals by Model Number

Product Code	Model	Inches			MM			Product Code	Model	Inches			MM		
		ID	OD	Width	ID	OD	Width			ID	OD	Width	ID	OD	Width
29516-7070	IG	3.000	3.813	0.863	76	97	22	24610-4557	26	3.000	4.000	0.500	76	102	13
24816-7023	EQUAL	3.000	3.818	1.375	76	97	35	24062-4557	61	3.000	4.000	0.500	76	102	13
25003-2171	23	3.000	3.875	0.375	76	98	10	24063-4557	61	3.000	4.000	0.500	76	102	13
25048-2171	25	3.000	3.875	0.375	76	98	10	24064-4557	61	3.000	4.000	0.500	76	102	13
21702-2171	62	3.000	3.875	0.375	76	98	10	24060-4557	61	3.000	4.000	0.500	76	102	13
21475-2171	63	3.000	3.875	0.375	76	98	10	21702-4557	62	3.000	4.000	0.500	76	102	13
21158-2171	63	3.000	3.875	0.375	76	98	10	21159-5310	63	3.000	4.000	0.563	76	102	14
21695-2171	63	3.000	3.875	0.375	76	98	10	29519-1220	IG	3.000	4.000	0.625	76	102	16
21702-2172	62	3.000	3.875	0.438	76	98	11	29619-1220	GD	3.000	4.000	0.625	76	102	16
21158-2172	63	3.000	3.875	0.438	76	98	11	24801-1220	EQUAL	3.000	4.000	0.625	76	102	16
25003-2173	23	3.000	3.875	0.500	76	98	13	24802-1220	EQUAL	3.000	4.000	0.625	76	102	16
21158-2173	63	3.000	3.875	0.500	76	98	13	24803-1220	EQUAL	3.000	4.000	0.625	76	102	16
24801-2173	EQUAL	3.000	3.875	0.500	76	98	13	24824-1220	EQUAL	3.000	4.000	0.625	76	102	16
24801-2172	EQUAL	3.000	3.875	0.625	76	98	16	24829-1220	EQUAL	3.000	4.000	0.625	76	102	16
24802-2172	EQUAL	3.000	3.875	0.625	76	98	16	29602-2175	GD	3.000	4.000	0.700	76	102	18
29602-4328	GD	3.000	3.875	0.700	76	98	18	29500-2175	IG	3.000	4.000	0.750	76	102	19
29620-4328	GD	3.000	3.875	0.700	76	98	18	29502-2175	IG	3.000	4.000	0.750	76	102	19
29502-4328	IG	3.000	3.875	0.750	76	98	19	29503-2175	IG	3.000	4.000	0.750	76	102	19
24600-2171	26	3.000	3.876	0.375	76	98	10	29520-2175	IG	3.000	4.000	0.750	76	102	19
21527-2173	66	3.000	3.876	0.500	76	98	13	29522-2175	IG	3.000	4.000	0.750	76	102	19
24802-1216	EQUAL	3.000	3.881	0.625	76	99	16	24801-2175	EQUAL	3.000	4.000	0.750	76	102	19
25009-7941	23	3.000	3.938	0.375	76	100	10	25010-2174	23	3.000	4.003	0.375	76	102	10
25003-7941	23	3.000	3.938	0.375	76	100	10	25003-2174	23	3.000	4.003	0.375	76	102	10
21158-7941	63	3.000	3.938	0.375	76	100	10	24626-2174	26	3.000	4.003	0.375	76	102	10
21168-7941	63	3.000	3.938	0.375	76	100	10	24600-2174	26	3.000	4.003	0.375	76	102	10
21702-1937	62	3.000	3.938	0.500	76	100	13	24610-2174	26	3.000	4.003	0.375	76	102	10
24801-3642	EQUAL	3.000	3.938	0.625	76	100	16	24602-2174	26	3.000	4.003	0.375	76	102	10
25001-5023	21	3.000	4.000	0.375	76	102	10	21695-2174	63	3.000	4.003	0.375	76	102	10
25278-5023	23	3.000	4.000	0.375	76	102	10	21290-2174	63	3.000	4.003	0.375	76	102	10
25003-5023	23	3.000	4.000	0.375	76	102	10	21159-2174	63	3.000	4.003	0.375	76	102	10
25006-5023	23	3.000	4.000	0.375	76	102	10	21475-2174	63	3.000	4.003	0.375	76	102	10
25004-5023	23	3.000	4.000	0.375	76	102	10	21158-2174	63	3.000	4.003	0.375	76	102	10
25284-5023	23	3.000	4.000	0.375	76	102	10	21500-2174	63	3.000	4.003	0.375	76	102	10
25058-5023	25	3.000	4.000	0.375	76	102	10	21168-2174	63	3.000	4.003	0.375	76	102	10
24060-5023	61	3.000	4.000	0.375	76	102	10	21527-2174	66	3.000	4.003	0.375	76	102	10
29609-5023	GD	3.000	4.000	0.375	76	102	10	21959-2174	67	3.000	4.003	0.375	76	102	10
25003-2565	23	3.000	4.000	0.406	76	102	10	21290-2175	63	3.000	4.003	0.437	76	102	11
25284-9915	23	3.000	4.000	0.437	76	102	11	21158-2175	63	3.000	4.003	0.438	76	102	11
25010-9915	23	3.000	4.000	0.438	76	102	11	25003-2176	23	3.000	4.003	0.500	76	102	13
25003-9915	23	3.000	4.000	0.438	76	102	11	25006-2176	23	3.000	4.003	0.500	76	102	13
25006-9915	23	3.000	4.000	0.438	76	102	11	25058-2176	25	3.000	4.003	0.500	76	102	13
24610-9915	26	3.000	4.000	0.438	76	102	11	21695-2176	63	3.000	4.003	0.500	76	102	13
24128-9915	61	3.000	4.000	0.438	76	102	11	21158-2176	63	3.000	4.003	0.500	76	102	13
24612-2977	26	3.000	4.000	0.468	76	102	12	21168-2176	63	3.000	4.003	0.500	76	102	13
21012-4557	113	3.000	4.000	0.500	76	102	13	21919-2176	63	3.000	4.003	0.500	76	102	13
25003-4557	23	3.000	4.000	0.500	76	102	13	21823-2176	68	3.000	4.003	0.500	76	102	13
25145-4557	23	3.000	4.000	0.500	76	102	13	23078-7328	63F1	3.000	4.003	0.594	76	102	15
25138-4557	23	3.000	4.000	0.500	76	102	13	23070-7328	63F1	3.000	4.003	0.594	76	102	15
25006-4557	23	3.000	4.000	0.500	76	102	13	29619-6145	GD	3.000	4.003	0.625	76	102	16
25004-4557	23	3.000	4.000	0.500	76	102	13	24802-3570	EQUAL	3.000	4.003	0.625	76	102	16
25009-4557	23	3.000	4.000	0.500	76	102	13	23547-7197	63R1	3.000	4.003	0.688	76	102	17
25058-4557	25	3.000	4.000	0.500	76	102	13	23548-7197	63R2	3.000	4.003	0.688	76	102	17
24626-4557	26	3.000	4.000	0.500	76	102	13	23627-7197	63R2	3.000	4.003	0.688	76	102	17
24627-4557	26	3.000	4.000	0.500	76	102	13	23550-7197	63T2	3.000	4.003	0.688	76	102	17
24600-4557	26	3.000	4.000	0.500	76	102	13	23549-7197	63TB	3.000	4.003	0.688	76	102	17
24683-4557	26	3.000	4.000	0.500	76	102	13	29602-6145	GD	3.000	4.003	0.700	76	102	18

All dimensions are in inches. Preferred sizes are indicated with **bold** type face.

Sizes listed are for standard nitrile elements, except Models 25 and 62 which have PTFE elements. Other material available on inquiry only.

Oil Seals by Model Number

Product Code	Model	Inches			MM			Product Code	Model	Inches			MM		
		ID	OD	Width	ID	OD	Width			ID	OD	Width	ID	OD	Width
29502-6145	IG	3.000	4.003	0.750	76	102	19	24627-2186	26	3.000	4.500	0.500	76	114	13
24802-2171	EQUAL	3.000	4.008	0.625	76	102	16	24600-2186	26	3.000	4.500	0.500	76	114	13
25284-9230	23	3.000	4.062	0.375	76	103	10	24610-2186	26	3.000	4.500	0.500	76	114	13
25003-9230	23	3.000	4.062	0.375	76	103	10	21597-2186	53	3.000	4.500	0.500	76	114	13
29602-1836	GD	3.000	4.062	0.700	76	103	18	21086-2186	53	3.000	4.500	0.500	76	114	13
25003-6868	23	3.000	4.125	0.375	76	105	10	21373-2186	53	3.000	4.500	0.500	76	114	13
24620-2187	26R1	3.000	4.125	0.438	76	105	11	21699-2186	53	3.000	4.500	0.500	76	114	13
24626-2187	26	3.000	4.125	0.438	76	105	11	21702-2186	62	3.000	4.500	0.500	76	114	13
24600-2187	26	3.000	4.125	0.438	76	105	11	21086-4546	53	3.000	4.500	0.563	76	114	14
25003-2177	23	3.000	4.125	0.500	76	105	13	21086-2188	53	3.000	4.500	0.625	76	114	16
24620-2177	26R1	3.000	4.125	0.500	76	105	13	24802-2091	EQUAL	3.000	4.500	0.625	76	114	16
24610-2177	26	3.000	4.125	0.500	76	105	13	29502-5333	IG	3.000	4.500	0.750	76	114	19
21087-2177	53	3.000	4.125	0.500	76	105	13	22897-6511	53T2	3.000	4.500	0.906	76	114	23
21597-2177	53	3.000	4.125	0.500	76	105	13	22897-5758	53T2	3.000	4.500	0.937	76	114	24
21086-2177	53	3.000	4.125	0.500	76	105	13	22897-7551	53T2	3.000	4.500	0.969	76	114	25
21683-2177	53	3.000	4.125	0.500	76	105	13	29502-7432	IG	3.000	4.504	0.750	76	114	19
21947-2177	53	3.000	4.125	0.500	76	105	13	24802-2492	EQUAL	3.000	4.617	0.625	76	117	16
21409-2177	53	3.000	4.125	0.500	76	105	13	21086-2189	53	3.000	4.625	0.500	76	117	13
21699-2177	53	3.000	4.125	0.500	76	105	13	29602-6645	GD	3.000	4.625	0.700	76	117	18
24801-2177	EQUAL	3.000	4.125	0.500	76	105	13	21086-7942	53	3.000	4.724	0.500	76	120	13
21086-2178	53	3.000	4.125	0.563	76	105	14	21095-7942	53	3.000	4.724	0.500	76	120	13
22501-2590	53G1	3.000	4.125	0.625	76	105	16	25058-2192	25	3.000	4.750	0.500	76	121	13
29519-2179	IG	3.000	4.125	0.625	76	105	16	21086-2192	53	3.000	4.750	0.500	76	121	13
24802-2179	EQUAL	3.000	4.125	0.625	76	105	16	21086-2195	53	3.000	4.875	0.500	76	124	13
29500-4361	IG	3.000	4.125	0.750	76	105	19	29502-4352	IG	3.000	4.910	0.750	76	125	19
29502-4361	IG	3.000	4.125	0.750	76	105	19	24600-2198	26	3.000	5.000	0.500	76	127	13
29520-6050	IG	3.000	4.160	0.750	76	106	19	21086-2198	53	3.000	5.000	0.500	76	127	13
29502-6864	IG	3.000	4.175	0.750	76	106	19	21699-2198	53	3.000	5.000	0.500	76	127	13
21086-2180	53	3.000	4.249	0.500	76	108	13	21702-2198	62	3.000	5.000	0.500	76	127	13
21086-2180	53	3.000	4.249	0.500	76	108	13	29502-5423	IG	3.000	5.000	0.750	76	127	19
21003-2180	58	3.000	4.249	0.500	76	108	13	29502-5215	IG	3.000	5.875	0.750	76	149	19
21702-2180	62	3.000	4.249	0.500	76	108	13	24802-2950	EQUAL	3.006	4.006	0.625	76	102	16
21086-2182	53	3.000	4.249	0.625	76	108	16	29502-5403	IG	3.008	4.008	0.750	76	102	19
21699-2182	53	3.000	4.249	0.625	76	108	16	24802-3138	EQUAL	3.010	4.010	0.625	76	102	16
25284-4804	23	3.000	4.250	0.500	76	108	13	29602-6801	GD	3.015	4.000	0.700	77	102	18
25003-4804	23	3.000	4.250	0.500	76	108	13	24802-3096	EQUAL	3.015	4.015	0.625	77	102	16
24600-2180	26	3.000	4.250	0.500	76	108	13	29502-5455	IG	3.016	4.016	0.750	77	102	19
24060-4804	61	3.000	4.250	0.500	76	108	13	29602-6905	GD	3.022	4.220	0.700	77	107	18
21086-9724	53	3.000	4.250	0.625	76	108	16	24823-4432	EQUAL	3.023	3.751	0.690	77	95	18
21699-9724	53	3.000	4.250	0.625	76	108	16	24816-7005	EQUAL	3.062	3.810	1.062	78	97	27
21003-9724	58	3.000	4.250	0.625	76	108	16	25003-3851	23	3.062	3.938	0.394	78	100	10
24801-9724	EQUAL	3.000	4.250	0.625	76	108	16	24602-8876	26	3.062	4.003	0.375	78	102	10
29602-6071	GD	3.000	4.250	0.700	76	108	18	24802-2201	EQUAL	3.062	4.062	0.625	78	103	16
29500-6071	IG	3.000	4.250	0.750	76	108	19	24610-6800	26	3.062	4.125	0.500	78	105	13
29502-6071	IG	3.000	4.250	0.750	76	108	19	21095-2201	53	3.062	4.125	0.500	78	105	13
29518-5733	IG	3.000	4.250	0.875	76	108	22	21699-2201	53	3.062	4.125	0.500	78	105	13
29521-5733	IG	3.000	4.250	0.875	76	108	22	21086-2202	53	3.062	4.125	0.563	78	105	14
21086-6435	53	3.000	4.331	0.500	76	110	13	21086-2210	53	3.062	4.500	0.500	78	114	13
25003-9649	23	3.000	4.375	0.375	76	111	10	21086-7945	53	3.062	4.724	0.500	78	120	13
25003-2183	23	3.000	4.375	0.500	76	111	13	21086-2221	53	3.062	4.875	0.625	78	124	16
21086-2183	53	3.000	4.375	0.500	76	111	13	25003-2108	23	3.063	4.000	0.500	78	102	13
29500-4507	IG	3.000	4.375	0.750	76	111	19	21702-8876	62	3.063	4.003	0.375	78	102	10
29502-4507	IG	3.000	4.375	0.750	76	111	19	26193-8876	76	3.063	4.003	0.375	78	102	10
24627-5310	26	3.000	4.437	0.625	76	113	16	25003-2200	23	3.063	4.063	0.500	78	103	13
25003-2186	23	3.000	4.500	0.500	76	114	13	29502-4285	IG	3.063	4.063	0.750	78	103	19
25009-2186	23	3.000	4.500	0.500	76	114	13	25284-2201	23	3.063	4.125	0.500	78	105	13

All dimensions are in inches. Preferred sizes are indicated with **bold** type face. Sizes listed are for standard nitrile elements, except Models 25 and 62 which have PTFE elements. Other material available on inquiry only.

## Oil Seals by Model Number

Product Code	Model	Inches			MM			Product Code	Model	Inches			MM		
		ID	OD	Width	ID	OD	Width			ID	OD	Width	ID	OD	Width
25003-2201	23	3.063	4.125	0.500	78	105	13	29500-4114	IG	3.125	4.125	0.750	79	105	19
21086-2201	53	3.063	4.125	0.500	78	105	13	29502-4114	IG	3.125	4.125	0.750	79	105	19
21702-2201	62	3.063	4.125	0.500	78	105	13	29503-4114	IG	3.125	4.125	0.750	79	105	19
21086-2204	53	3.063	4.249	0.500	78	108	13	22627-6739	53R2	3.125	4.125	0.906	79	105	23
21086-2219	53	3.063	4.875	0.500	78	124	13	24802-1207	EQUAL	3.125	4.130	0.625	79	105	16
21086-2222	53	3.063	5.000	0.500	78	127	13	25003-2685	23	3.125	4.188	0.500	79	106	13
25003-4769	23	3.070	3.938	0.437	78	100	11	24620-2216	26R1	3.125	4.249	0.438	79	108	11
24802-3024	EQUAL	3.071	3.937	0.625	78	100	16	25003-2228	23	3.125	4.249	0.500	79	108	13
29602-4973	GD	3.071	3.937	0.700	78	100	18	21086-2228	53	3.125	4.249	0.500	79	108	13
25003-7144	23	3.071	4.071	0.500	78	103	13	21699-2228	53	3.125	4.249	0.500	79	108	13
29502-5395	IG	3.071	4.331	0.750	78	110	19	21096-2229	53	3.125	4.249	0.563	79	108	14
25003-4954	23	3.071	4.571	0.500	78	116	13	21086-2229	53	3.125	4.249	0.563	79	108	14
24802-2643	EQUAL	3.075	4.325	0.625	78	110	16	21086-2230	53	3.125	4.249	0.625	79	108	16
29502-5657	IG	3.100	4.100	0.750	79	104	19	25003-6862	23	3.125	4.250	0.375	79	108	10
29502-5763	IG	3.110	4.331	0.750	79	110	19	25010-5025	23	3.125	4.250	0.500	79	108	13
24802-2209	EQUAL	3.122	4.000	0.625	79	102	16	25003-5025	23	3.125	4.250	0.500	79	108	13
29507-6416	IG	3.125	3.750	0.625	79	95	16	25006-5025	23	3.125	4.250	0.500	79	108	13
25001-7213	21	3.125	3.875	0.375	79	98	10	24626-0914	26	3.125	4.250	0.500	79	108	13
25010-7213	23	3.125	3.875	0.375	79	98	10	24600-0914	26	3.125	4.250	0.500	79	108	13
25003-7213	23	3.125	3.875	0.375	79	98	10	24610-0914	26	3.125	4.250	0.500	79	108	13
24600-7213	26	3.125	3.875	0.375	79	98	10	24600-7682	26	3.125	4.250	0.625	79	108	16
24610-7213	26	3.125	3.875	0.375	79	98	10	24801-7682	EQUAL	3.125	4.250	0.625	79	108	16
29502-4775	IG	3.125	3.875	0.750	79	98	19	29500-5066	IG	3.125	4.250	0.750	79	108	19
29502-4777	IG	3.125	3.938	0.750	79	100	19	29502-5066	IG	3.125	4.250	0.750	79	108	19
24060-1569	61	3.125	4.000	0.375	79	102	10	29502-5723	IG	3.125	4.312	0.750	79	110	19
25003-5209	23	3.125	4.000	0.500	79	102	13	25003-2231	23	3.125	4.375	0.500	79	111	13
25006-5209	23	3.125	4.000	0.500	79	102	13	21086-2231	53	3.125	4.375	0.500	79	111	13
24622-4133	26R1	3.125	4.000	0.500	79	102	13	21699-2231	53	3.125	4.375	0.500	79	111	13
29507-2222	IG	3.125	4.000	0.625	79	102	16	24060-2231	61	3.125	4.375	0.500	79	111	13
24801-2222	EQUAL	3.125	4.000	0.625	79	102	16	24802-2224	EQUAL	3.125	4.375	0.625	79	111	16
24829-2222	EQUAL	3.125	4.000	0.625	79	102	16	25003-2358	23	3.125	4.500	0.438	79	114	11
29602-6722	GD	3.125	4.000	0.700	79	102	18	24626-4870	26	3.125	4.500	0.472	79	114	12
29502-5362	IG	3.125	4.003	0.750	79	102	19	25003-2234	23	3.125	4.500	0.500	79	114	13
25003-3172	23	3.125	4.008	0.375	79	102	10	21086-2234	53	3.125	4.500	0.500	79	114	13
25003-6102	23	3.125	4.125	0.438	79	105	11	21699-2234	53	3.125	4.500	0.500	79	114	13
25010-2225	23	3.125	4.125	0.500	79	105	13	21086-2236	53	3.125	4.500	0.625	79	114	16
25003-2225	23	3.125	4.125	0.500	79	105	13	24600-2237	26	3.125	4.625	0.500	79	117	13
25006-2225	23	3.125	4.125	0.500	79	105	13	21086-2237	53	3.125	4.625	0.500	79	117	13
25009-2225	23	3.125	4.125	0.500	79	105	13	21702-2237	62	3.125	4.625	0.500	79	117	13
24650-2225	26NS	3.125	4.125	0.500	79	105	13	21699-2240	53	3.125	4.750	0.500	79	121	13
24626-2225	26	3.125	4.125	0.500	79	105	13	21086-2240	53	3.125	4.750	0.500	79	121	13
24635-2225	26	3.125	4.125	0.500	79	105	13	21086-2243	53	3.125	4.875	0.500	79	124	13
24627-2225	26	3.125	4.125	0.500	79	105	13	22897-7181	53T2	3.125	4.875	0.969	79	124	25
24600-2225	26	3.125	4.125	0.500	79	105	13	21086-2246	53	3.125	5.000	0.500	79	127	13
24610-2225	26	3.125	4.125	0.500	79	105	13	22627-6968	53R2	3.125	5.000	0.906	79	127	23
21086-2225	53	3.125	4.125	0.500	79	105	13	29502-4888	IG	3.140	4.140	0.750	80	105	19
21409-2225	53	3.125	4.125	0.500	79	105	13	29602-5055	GD	3.142	4.142	0.700	80	105	18
21699-2225	53	3.125	4.125	0.500	79	105	13	29502-5055	IG	3.142	4.142	0.750	80	105	19
21003-2225	58	3.125	4.125	0.500	79	105	13	29602-6728	GD	3.144	4.144	0.700	80	105	18
21702-2225	62	3.125	4.125	0.500	79	105	13	29502-6591	IG	3.146	4.500	0.750	80	114	19
21086-2226	53	3.125	4.125	0.563	79	105	14	29502-6017	IG	3.147	4.147	0.750	80	105	19
29619-2223	GD	3.125	4.125	0.625	79	105	16	29602-6962	GD	3.149	3.937	0.700	80	100	18
24802-2223	EQUAL	3.125	4.125	0.625	79	105	16	24627-2242	26	3.149	3.938	0.393	80	100	10
24819-2223	EQUAL	3.125	4.125	0.625	79	105	16	24802-1739	EQUAL	3.149	3.942	0.625	80	100	16
24822-2223	EQUAL	3.125	4.125	0.625	79	105	16	24819-1739	EQUAL	3.149	3.942	0.625	80	100	16
29602-4114	GD	3.125	4.125	0.700	79	105	18	29602-6944	GD	3.149	4.090	0.700	80	104	18

All dimensions are in inches. Preferred sizes are indicated with **bold** type face.

Sizes listed are for standard nitrile elements, except Models 25 and 62 which have PTFE elements. Other material available on inquiry only.



## Oil Seals by Model Number

Product Code	Model	Inches			MM			Product Code	Model	Inches			MM		
		ID	OD	Width	ID	OD	Width			ID	OD	Width	ID	OD	Width
29502-5313	IG	3.149	4.122	0.750	80	105	19	29500-4974	IG	3.150	4.331	0.750	80	110	19
29602-3253	GD	3.149	4.173	0.700	80	106	18	29502-4974	IG	3.150	4.331	0.750	80	110	19
29502-3253	IG	3.149	4.173	0.750	80	106	19	29519-5641	IG	3.150	4.375	0.625	80	111	16
24802-1813	EQUAL	3.149	4.500	0.625	80	114	16	24626-4854	26	3.150	4.409	0.492	80	112	12
29500-5487	IG	3.149	4.724	0.750	80	120	19	29602-7435	GD	3.150	4.409	0.700	80	112	18
24622-1033	26R1	3.150	3.937	0.394	80	100	10	29518-5804	IG	3.150	4.409	0.875	80	112	22
24620-1033	26R1	3.150	3.937	0.394	80	100	10	29502-5622	IG	3.150	4.500	0.750	80	114	19
24610-2242	26	3.150	3.937	0.394	80	100	10	24801-2239	EQUAL	3.150	4.528	0.500	80	115	13
24620-2215	26R1	3.150	4.134	0.512	80	105	13	29502-6027	IG	3.150	4.530	0.750	80	115	19
24648-1033	26	3.150	3.937	0.394	80	100	10	29500-5293	IG	3.150	4.724	0.750	80	120	19
24069-1033	61	3.150	3.937	0.394	80	100	10	29502-5293	IG	3.150	4.724	0.750	80	120	19
24064-1033	61	3.150	3.937	0.394	80	100	10	24801-5269	EQUAL	3.150	5.118	0.625	80	130	16
24060-1033	61	3.150	3.937	0.394	80	100	10	24629-1033	26R1	3.153	3.937	0.394	80	100	10
21003-3085	58	3.150	3.937	0.472	80	100	12	29502-4655	IG	3.156	4.250	0.750	80	108	19
24610-2238	26	3.150	3.937	0.512	80	100	13	29505-5791	IG	3.158	4.158	0.500	80	106	13
29507-2240	IG	3.150	3.937	0.625	80	100	16	29507-5218	IG	3.158	4.158	0.625	80	106	16
29519-2240	IG	3.150	3.937	0.625	80	100	16	29502-5169	IG	3.158	4.158	0.750	80	106	19
29602-4798	GD	3.150	3.937	0.700	80	100	18	25003-9704	23	3.167	4.167	0.500	80	106	13
29602-7300	GD	3.150	3.937	0.700	80	100	18	29502-6201	IG	3.185	4.185	0.750	81	106	19
29500-4798	IG	3.150	3.937	0.750	80	100	19	21086-7950	53	3.187	4.331	0.500	81	110	13
29502-4798	IG	3.150	3.937	0.750	80	100	19	21947-7950	53	3.187	4.331	0.500	81	110	13
29524-4798	IG	3.150	3.937	0.750	80	100	19	25003-2632	23	3.187	4.447	0.500	81	113	13
25003-1033	23	3.150	3.938	0.394	80	100	10	21003-2255	58	3.187	4.500	0.500	81	114	13
25006-1033	23	3.150	3.938	0.394	80	100	10	21086-8121	53	3.187	4.724	0.500	81	120	13
24602-1033	26	3.150	3.938	0.394	80	100	10	29607-6704	GD	3.188	3.625	0.625	81	92	16
21702-1938	62	3.150	3.938	0.500	80	100	13	29507-5136	IG	3.188	3.688	0.625	81	94	16
24626-2238	26	3.150	3.938	0.512	80	100	13	29516-7156	IG	3.188	4.083	0.862	81	104	22
24600-2238	26	3.150	3.938	0.512	80	100	13	29502-6068	IG	3.188	4.125	0.750	81	105	19
24602-2238	26	3.150	3.938	0.512	80	100	13	25003-7656	23	3.188	4.188	0.375	81	106	10
24801-2240	EQUAL	3.150	3.938	0.625	80	100	16	25006-7656	23	3.188	4.188	0.375	81	106	10
24802-2240	EQUAL	3.150	3.938	0.625	80	100	16	25004-7656	23	3.188	4.188	0.375	81	106	10
24807-3674	EQUAL	3.150	3.938	0.690	80	100	18	25009-7656	23	3.188	4.188	0.375	81	106	10
24802-6193	EQUAL	3.150	4.016	0.625	80	102	16	25003-4948	23	3.188	4.188	0.500	81	106	13
24806-6193	EQUAL	3.150	4.016	0.625	80	102	16	24610-0651	26	3.188	4.188	0.500	81	106	13
24060-2411	61	3.150	4.134	0.394	80	105	10	24822-2741	EQUAL	3.188	4.188	0.625	81	106	16
25003-3795	23	3.150	4.134	0.500	80	105	13	29602-4286	GD	3.188	4.188	0.700	81	106	18
24829-2215	EQUAL	3.150	4.134	0.500	80	105	13	29502-4286	IG	3.188	4.188	0.750	81	106	19
24600-2215	26	3.150	4.134	0.512	80	105	13	25003-2515	23	3.188	4.249	0.438	81	108	11
29507-2272	IG	3.150	4.134	0.625	80	105	16	25003-2249	23	3.188	4.249	0.500	81	108	13
24801-2272	EQUAL	3.150	4.134	0.625	80	105	16	24627-2249	26	3.188	4.249	0.500	81	108	13
29502-4728	IG	3.150	4.135	0.750	80	105	19	21087-2249	53	3.188	4.249	0.500	81	108	13
24610-5380	26	3.150	4.150	0.500	80	105	13	21086-2249	53	3.188	4.249	0.500	81	108	13
29602-5141	GD	3.150	4.150	0.700	80	105	18	21095-2249	53	3.188	4.249	0.500	81	108	13
29502-5141	IG	3.150	4.150	0.750	80	105	19	21409-2249	53	3.188	4.249	0.500	81	108	13
29502-6431	IG	3.150	4.175	0.750	80	106	19	21527-2249	66	3.188	4.249	0.500	81	108	13
25003-4768	23	3.150	4.249	0.438	80	108	11	24801-5047	EQUAL	3.188	4.249	0.625	81	108	16
29502-4574	IG	3.150	4.250	0.750	80	108	19	24802-5047	EQUAL	3.188	4.249	0.625	81	108	16
24600-2243	26	3.150	4.330	0.237	80	110	6	22537-6461	53R1	3.188	4.249	0.906	81	108	23
24060-0831	61	3.150	4.331	0.394	80	110	10	22627-6461	53R2	3.188	4.249	0.906	81	108	23
25003-7426	23	3.150	4.331	0.472	80	110	12	22897-5941	53T2	3.188	4.249	0.969	81	108	25
21086-7426	53	3.150	4.331	0.472	80	110	12	25058-2249	25	3.188	4.250	0.500	81	108	13
25003-1998	23	3.150	4.331	0.500	80	110	13	21597-2249	53	3.188	4.250	0.500	81	108	13
25004-1998	23	3.150	4.331	0.500	80	110	13	21699-2249	53	3.188	4.250	0.500	81	108	13
24801-3593	EQUAL	3.150	4.331	0.625	80	110	16	29602-4550	GD	3.188	4.250	0.700	81	108	18
24802-3593	EQUAL	3.150	4.331	0.625	80	110	16	29620-4550	GD	3.188	4.250	0.700	81	108	18
29602-4974	GD	3.150	4.331	0.700	80	110	18	29502-4550	IG	3.188	4.250	0.750	81	108	19

All dimensions are in inches. Preferred sizes are indicated with **bold** type face. Sizes listed are for standard nitrile elements, except Models 25 and 62 which have PTFE elements. Other material available on inquiry only.

## Oil Seals by Model Number

Product Code	Model	Inches			MM			Product Code	Model	Inches			MM		
		ID	OD	Width	ID	OD	Width			ID	OD	Width	ID	OD	Width
24803-1046	EQUAL	3.188	4.254	0.500	81	108	13	24802-1028	EQUAL	3.250	4.000	0.625	83	102	16
25003-5132	23	3.188	4.313	0.500	81	110	13	29519-7440	IG	3.250	4.000	0.640	83	102	16
24802-3005	EQUAL	3.188	4.313	0.625	81	110	16	24807-2855	EQUAL	3.250	4.000	0.690	83	102	18
29502-5044	IG	3.188	4.313	0.750	81	110	19	29602-4186	GD	3.250	4.000	0.700	83	102	18
29516-5131	IG	3.188	4.335	0.994	81	110	25	29502-4186	IG	3.250	4.000	0.750	83	102	19
29516-7108	IG	3.188	4.335	1.050	81	110	27	24802-1237	EQUAL	3.250	4.003	0.625	83	102	16
24816-7119	EQUAL	3.188	4.335	1.298	81	110	33	23683-4395	67R2	3.250	4.003	0.688	83	102	17
24816-7131	EQUAL	3.188	4.335	1.312	81	110	33	29602-2414	GD	3.250	4.003	0.700	83	102	18
24839-7131	EQUAL	3.188	4.335	1.312	81	110	33	25003-6121	23	3.250	4.125	0.438	83	105	11
24600-2218	26	3.188	4.340	0.305	81	110	8	25003-5426	23	3.250	4.125	0.500	83	105	13
25003-2252	23	3.188	4.375	0.500	81	111	13	24600-2269	26	3.250	4.125	0.563	83	105	14
21096-2252	53	3.188	4.375	0.500	81	111	13	24610-3215	26	3.250	4.138	0.437	83	105	11
21086-2252	53	3.188	4.375	0.500	81	111	13	25003-1586	23	3.250	4.225	0.375	83	107	10
21699-2252	53	3.188	4.375	0.500	81	111	13	25009-1586	23	3.250	4.225	0.375	83	107	10
21086-2254	53	3.188	4.375	0.625	81	111	16	25003-8233	23	3.250	4.249	0.375	83	108	10
29502-6423	IG	3.188	4.375	0.750	81	111	19	25004-8233	23	3.250	4.249	0.375	83	108	10
25003-0521	23	3.188	4.437	0.375	81	113	10	24600-8233	26	3.250	4.249	0.375	83	108	10
24801-1759	EQUAL	3.188	4.499	0.469	81	114	12	25003-3265	23	3.250	4.249	0.468	83	108	12
25003-2255	23	3.188	4.500	0.500	81	114	13	25010-2270	23	3.250	4.249	0.500	83	108	13
24600-3415	26	3.188	4.500	0.500	81	114	13	25003-2270	23	3.250	4.249	0.500	83	108	13
21088-2255	53	3.188	4.500	0.500	81	114	13	21096-2270	53	3.250	4.249	0.500	83	108	13
21086-2255	53	3.188	4.500	0.500	81	114	13	21087-2270	53	3.250	4.249	0.500	83	108	13
21699-2255	53	3.188	4.500	0.500	81	114	13	21088-2270	53	3.250	4.249	0.500	83	108	13
21086-2261	53	3.188	4.750	0.500	81	121	13	21086-2270	53	3.250	4.249	0.500	83	108	13
21699-2261	53	3.188	4.750	0.500	81	121	13	21091-2270	53	3.250	4.249	0.500	83	108	13
21702-2261	62	3.188	4.750	0.500	81	121	13	21093-2270	53	3.250	4.249	0.500	83	108	13
21086-2264	53	3.188	4.875	0.500	81	124	13	21683-2270	53	3.250	4.249	0.500	83	108	13
24620-2669	26R1	3.188	5.000	0.438	81	127	11	21947-2270	53	3.250	4.249	0.500	83	108	13
24600-2267	26	3.188	5.000	0.500	81	127	13	21409-2270	53	3.250	4.249	0.500	83	108	13
21086-2267	53	3.188	5.000	0.500	81	127	13	21699-2270	53	3.250	4.249	0.500	83	108	13
22502-0941	53G1	3.188	5.000	0.625	81	127	16	21702-2270	62	3.250	4.249	0.500	83	108	13
24802-3777	EQUAL	3.188	5.000	0.625	81	127	16	21086-2271	53	3.250	4.249	0.563	83	108	14
22897-8608	53T2	3.188	5.000	0.969	81	127	25	21086-2272	53	3.250	4.249	0.625	83	108	16
29502-5213	IG	3.189	4.252	0.750	81	108	19	21699-2272	53	3.250	4.249	0.625	83	108	16
24802-3017	EQUAL	3.201	4.201	0.625	81	107	16	22987-7670	53F1	3.250	4.249	0.750	83	108	19
25003-9830	23	3.219	4.469	0.500	82	114	13	22544-6708	53R1	3.250	4.249	0.906	83	108	23
24600-2111	26	3.225	3.975	0.375	82	101	10	22537-6708	53R1	3.250	4.249	0.906	83	108	23
25003-1986	23	3.228	4.102	0.375	82	104	10	22627-6708	53R2	3.250	4.249	0.906	83	108	23
24802-3109	EQUAL	3.228	4.448	0.625	82	113	16	25010-6356	23	3.250	4.250	0.375	83	108	10
25006-1590	23	3.228	4.488	0.500	82	114	13	25003-6356	23	3.250	4.250	0.375	83	108	10
25003-2385	23	3.238	4.180	0.500	82	106	13	25006-6356	23	3.250	4.250	0.375	83	108	10
25004-2290	23	3.239	4.245	0.500	82	108	13	25004-6356	23	3.250	4.250	0.375	83	108	10
26001-8810	71	3.250	3.813	0.109	83	97	3	25058-6356	25	3.250	4.250	0.375	83	108	10
24060-1572	61	3.250	3.875	0.312	83	98	8	24610-6839	26	3.250	4.250	0.437	83	108	11
24062-2318	61	3.250	3.875	0.375	83	98	10	25138-6839	23	3.250	4.250	0.438	83	108	11
29507-6409	IG	3.250	3.875	0.625	83	98	16	25003-6839	23	3.250	4.250	0.438	83	108	11
26193-6591	76	3.250	3.940	0.250	83	100	6	25004-6839	23	3.250	4.250	0.438	83	108	11
24600-2262	26	3.250	4.000	0.250	83	102	6	24627-6839	26	3.250	4.250	0.438	83	108	11
24660-2263	26HR	3.250	4.000	0.375	83	102	10	24600-6839	26	3.250	4.250	0.438	83	108	11
24610-2263	26	3.250	4.000	0.375	83	102	10	24602-0778	26	3.250	4.250	0.469	83	108	12
21959-5551	67	3.250	4.000	0.375	83	102	10	25003-7374	23	3.250	4.250	0.500	83	108	13
21528-5551	67	3.250	4.000	0.375	83	102	10	25006-7374	23	3.250	4.250	0.500	83	108	13
24060-1574	61	3.250	4.000	0.437	83	102	11	25004-7374	23	3.250	4.250	0.500	83	108	13
24600-2265	26	3.250	4.000	0.438	83	102	11	24626-7374	26	3.250	4.250	0.500	83	108	13
29607-1028	GD	3.250	4.000	0.625	83	102	16	24627-7374	26	3.250	4.250	0.500	83	108	13
24801-1028	EQUAL	3.250	4.000	0.625	83	102	16	24600-7374	26	3.250	4.250	0.500	83	108	13

All dimensions are in inches. Preferred sizes are indicated with **bold** type face.

Sizes listed are for standard nitrile elements, except Models 25 and 62 which have PTFE elements. Other material available on inquiry only.

## Oil Seals by Model Number

Product Code	Model	Inches			MM			Product Code	Model	Inches			MM		
		ID	OD	Width	ID	OD	Width			ID	OD	Width	ID	OD	Width
24610-7374	26	3.250	4.250	0.500	83	108	13	21086-2282	53	3.250	4.750	0.500	83	121	13
24060-7374	61	3.250	4.250	0.500	83	108	13	24060-2282	61	3.250	4.750	0.500	83	121	13
24801-2280	EQUAL	3.250	4.250	0.625	83	108	16	21086-2284	53	3.250	4.750	0.625	83	121	16
24802-2280	EQUAL	3.250	4.250	0.625	83	108	16	29502-6326	IG	3.250	4.750	0.750	83	121	19
24803-2280	EQUAL	3.250	4.250	0.625	83	108	16	21012-4558	113	3.250	4.813	0.500	83	122	13
24824-2280	EQUAL	3.250	4.250	0.625	83	108	16	21086-2287	53	3.250	4.875	0.625	83	124	16
24829-2280	EQUAL	3.250	4.250	0.625	83	108	16	21096-2288	53	3.250	4.999	0.500	83	127	13
24835-2280	EQUAL	3.250	4.250	0.625	83	108	16	29505-4461	IG	3.250	4.999	0.625	83	127	16
29602-4154	GD	3.250	4.250	0.700	83	108	18	21086-2288	53	3.250	5.000	0.500	83	127	13
29500-4154	IG	3.250	4.250	0.750	83	108	19	29521-6046	IG	3.250	5.000	0.875	83	127	22
29502-4154	IG	3.250	4.250	0.750	83	108	19	22627-8441	53R2	3.250	5.000	0.906	83	127	23
22627-7419	53R2	3.250	4.250	0.969	83	108	25	21086-7955	53	3.250	5.118	0.500	83	130	13
23708-7419	53R2	3.250	4.250	0.969	83	108	25	22537-5094	53R1	3.250	5.125	0.844	83	130	21
22897-7419	53T2	3.250	4.250	0.969	83	108	25	29502-5816	IG	3.250	5.250	0.750	83	133	19
24610-3248	26	3.250	4.313	0.500	83	110	13	29602-6930	GD	3.250	5.999	0.700	83	152	18
24802-3009	EQUAL	3.250	4.313	0.625	83	110	16	29602-6997	GD	3.250	6.020	0.700	83	153	18
24824-3009	EQUAL	3.250	4.313	0.625	83	110	16	25003-5682	23	3.280	4.280	0.375	83	109	10
29516-7096	IG	3.250	4.335	1.124	83	110	29	29602-6973	GD	3.304	4.304	0.700	84	109	18
24816-7050	EQUAL	3.250	4.335	1.313	83	110	33	29507-6139	IG	3.307	3.976	0.625	84	101	16
24824-3562	EQUAL	3.250	4.336	0.625	83	110	16	29516-7178	IG	3.307	3.976	0.765	84	101	19
25003-2273	23	3.250	4.375	0.500	83	111	13	29502-5761	IG	3.307	4.307	0.750	84	109	19
24649-0916	26	3.250	4.375	0.500	83	111	13	21003-4410	58	3.307	4.331	0.500	84	110	13
21086-2273	53	3.250	4.375	0.500	83	111	13	24626-2562	26	3.307	4.331	0.551	84	110	14
21699-2273	53	3.250	4.375	0.500	83	111	13	24600-2562	26	3.307	4.331	0.551	84	110	14
21702-2273	62	3.250	4.375	0.500	83	111	13	24801-1988	EQUAL	3.307	4.331	0.625	84	110	16
24802-2286	EQUAL	3.250	4.375	0.625	83	111	16	24802-1988	EQUAL	3.307	4.331	0.625	84	110	16
29502-6828	IG	3.250	4.375	0.750	83	111	19	29502-6393	IG	3.307	4.350	0.750	84	110	19
25003-5460	23	3.250	4.500	0.438	83	114	11	29500-6052	IG	3.310	4.310	0.750	84	109	19
25003-2276	23	3.250	4.500	0.500	83	114	13	29502-5984	IG	3.312	4.061	0.750	84	103	19
25004-2276	23	3.250	4.500	0.500	83	114	13	29502-4826	IG	3.312	4.213	0.750	84	107	19
25058-2276	25	3.250	4.500	0.500	83	114	13	25003-1628	23	3.312	4.250	0.500	84	108	13
24627-2276	26	3.250	4.500	0.500	83	114	13	24626-2297	26	3.312	4.375	0.500	84	111	13
21086-2276	53	3.250	4.500	0.500	83	114	13	29502-6320	IG	3.312	4.437	0.750	84	113	19
21095-2276	53	3.250	4.500	0.500	83	114	13	21086-2302	53	3.312	4.500	0.625	84	114	16
21699-2276	53	3.250	4.500	0.500	83	114	13	24600-2305	26	3.312	5.000	0.468	84	127	12
24060-2276	61	3.250	4.500	0.500	83	114	13	25003-9539	23	3.313	4.125	0.438	84	105	11
21087-2277	53	3.250	4.500	0.563	83	114	14	25003-4879	23	3.313	4.125	0.500	84	105	13
21086-2277	53	3.250	4.500	0.563	83	114	14	29619-2296	GD	3.313	4.125	0.625	84	105	16
21086-2278	53	3.250	4.500	0.625	83	114	16	24802-2296	EQUAL	3.313	4.125	0.625	84	105	16
29507-2278	IG	3.250	4.500	0.625	83	114	16	24819-2296	EQUAL	3.313	4.125	0.625	84	105	16
29519-2278	IG	3.250	4.500	0.625	83	114	16	24807-2846	EQUAL	3.313	4.125	0.690	84	105	18
29602-4425	GD	3.250	4.500	0.700	83	114	18	29602-4113	GD	3.313	4.125	0.700	84	105	18
29500-4425	IG	3.250	4.500	0.750	83	114	19	29500-4113	IG	3.313	4.125	0.750	84	105	19
29502-4425	IG	3.250	4.500	0.750	83	114	19	29502-4113	IG	3.313	4.125	0.750	84	105	19
22627-8700	53R2	3.250	4.500	0.844	83	114	21	29503-4113	IG	3.313	4.125	0.750	84	105	19
29518-5708	IG	3.250	4.500	0.875	83	114	22	29520-4113	IG	3.313	4.125	0.750	84	105	19
22627-6528	53R2	3.250	4.500	0.906	83	114	23	24802-1209	EQUAL	3.313	4.130	0.625	84	105	16
29602-6964	GD	3.250	4.525	0.700	83	115	18	24610-4543	26	3.313	4.249	0.313	84	108	8
25003-2279	23	3.250	4.625	0.500	83	117	13	25003-6128	23	3.313	4.250	0.438	84	108	11
24622-2279	26R1	3.250	4.625	0.500	83	117	13	29502-5975	IG	3.313	4.250	0.750	84	108	19
21086-2279	53	3.250	4.625	0.500	83	117	13	25003-7591	23	3.313	4.313	0.375	84	110	10
21699-2279	53	3.250	4.625	0.500	83	117	13	25003-7841	23	3.313	4.313	0.500	84	110	13
29502-6705	IG	3.250	4.625	0.750	83	117	19	25064-7841	25	3.313	4.313	0.500	84	110	13
21086-7953	53	3.250	4.724	0.500	83	120	13	29602-4287	GD	3.313	4.313	0.700	84	110	18
25003-5160	23	3.250	4.750	0.438	83	121	11	29502-4287	IG	3.313	4.313	0.750	84	110	19
25003-2282	23	3.250	4.750	0.500	83	121	13	29522-4287	IG	3.313	4.313	0.750	84	110	19

All dimensions are in inches. Preferred sizes are indicated with **bold** type face. Sizes listed are for standard nitrile elements, except Models 25 and 62 which have PTFE elements. Other material available on inquiry only.

## Oil Seals by Model Number

Product Code	Model	Inches			MM			Product Code	Model	Inches			MM		
		ID	OD	Width	ID	OD	Width			ID	OD	Width	ID	OD	Width
21086-6903	53	3.313	4.331	0.500	84	110	13	29608-6702	GD	3.346	4.331	0.625	85	110	16
25064-0942	25	3.313	4.336	0.500	84	110	13	24801-6702	EQUAL	3.346	4.331	0.625	85	110	16
25003-2297	23	3.313	4.375	0.500	84	111	13	24802-5650	EQUAL	3.346	4.331	0.625	85	110	16
25006-2297	23	3.313	4.375	0.500	84	111	13	29602-4193	GD	3.346	4.331	0.700	85	110	18
24600-2297	26	3.313	4.375	0.500	84	111	13	29502-4193	IG	3.346	4.331	0.750	85	110	19
24610-2297	26	3.313	4.375	0.500	84	111	13	29502-5398	IG	3.346	4.335	0.750	85	110	19
21020-2297	50	3.313	4.375	0.500	84	111	13	29521-5976	IG	3.346	4.346	0.875	85	110	22
21088-2297	53	3.313	4.375	0.500	84	111	13	29516-7142	IG	3.346	4.370	0.764	85	111	19
21086-2297	53	3.313	4.375	0.500	84	111	13	24802-1814	EQUAL	3.346	4.375	0.625	85	111	16
21702-2297	62	3.313	4.375	0.500	84	111	13	29502-6492	IG	3.346	4.488	0.750	85	114	19
24802-3966	EQUAL	3.313	4.375	0.625	84	111	16	24801-3584	EQUAL	3.346	4.528	0.551	85	115	14
29502-4477	IG	3.313	4.375	0.750	84	111	19	24801-2311	EQUAL	3.346	4.528	0.630	85	115	16
25003-2301	23	3.313	4.500	0.469	84	114	12	25003-7394	23	3.346	4.724	0.472	85	120	12
25003-2300	23	3.313	4.500	0.500	84	114	13	21086-7394	53	3.346	4.724	0.472	85	120	12
21086-2300	53	3.313	4.500	0.500	84	114	13	21699-7394	53	3.346	4.724	0.472	85	120	12
21095-2300	53	3.313	4.500	0.500	84	114	13	24801-5521	EQUAL	3.346	4.724	0.625	85	120	16
24802-2304	EQUAL	3.313	4.500	0.625	84	114	16	21096-7399	53	3.346	4.921	0.472	85	125	12
22987-0238	53F1	3.313	4.500	0.719	84	114	18	21086-7399	53	3.346	4.921	0.472	85	125	12
29502-6816	IG	3.313	4.500	0.750	84	114	19	29500-4816	IG	3.346	4.921	0.750	85	125	19
21086-2303	53	3.313	4.625	0.500	84	117	13	29519-5110	IG	3.346	5.118	0.625	85	130	16
21086-2306	53	3.313	4.750	0.500	84	121	13	24802-5110	EQUAL	3.346	5.118	0.625	85	130	16
21086-2312	53	3.313	5.000	0.500	84	127	13	24060-1853	61	3.346	4.134	0.394	85	105	10
21086-2315	53	3.313	5.125	0.500	84	130	13	24060-1854	61	3.346	4.331	0.394	85	110	10
21086-0989	53	3.313	5.250	0.500	84	133	13	24600-2214	26	3.346	4.331	0.472	85	110	12
24060-2562	61	3.320	4.132	0.450	84	105	11	24622-5343	26R1	3.346	4.331	0.512	85	110	13
29602-6826	GD	3.320	4.320	0.700	84	110	18	24600-5343	26	3.346	4.331	0.512	85	110	13
29602-6874	GD	3.325	4.425	0.700	84	112	18	24620-7394	26R1	3.346	4.724	0.472	85	120	12
24802-3139	EQUAL	3.335	4.335	0.625	85	110	16	24627-2310	26	3.347	4.134	0.512	85	105	13
29602-5087	GD	3.335	4.335	0.700	85	110	18	24064-1854	61	3.347	4.331	0.394	85	110	10
29500-5087	IG	3.335	4.335	0.750	85	110	19	29602-6753	GD	3.347	4.347	0.700	85	110	18
29602-6807	GD	3.337	4.337	0.700	85	110	18	29502-7424	IG	3.347	4.347	0.750	85	110	19
29602-6994	GD	3.339	4.339	0.700	85	110	18	24610-5212	26	3.347	4.607	0.493	85	117	13
25003-8693	23	3.344	4.344	0.375	85	110	10	29602-6875	GD	3.350	4.350	0.700	85	110	18
25003-6752	23	3.344	4.344	0.500	85	110	13	29602-6954	GD	3.366	4.469	0.700	85	114	18
25003-5777	23	3.344	4.437	0.500	85	113	13	29602-7478	GD	3.372	4.372	0.700	86	111	18
27223-6314	94	3.344	5.118	0.500	85	130	13	29602-6761	GD	3.372	4.510	0.700	86	115	18
24060-3986	61	3.345	4.250	0.500	85	108	13	24803-3222	EQUAL	3.373	4.373	0.625	86	111	16
24802-3299	EQUAL	3.345	4.304	0.625	85	109	16	29602-6760	GD	3.374	4.505	0.700	86	114	18
29502-4722	IG	3.345	4.320	0.750	85	110	19	24801-5370	EQUAL	3.375	3.952	0.375	86	100	10
29500-4193	IG	3.345	4.331	0.750	85	110	19	24060-1580	61	3.375	4.000	0.312	86	102	8
29507-6469	IG	3.346	3.937	0.625	85	100	16	29507-5677	IG	3.375	4.000	0.625	86	102	16
24807-5104	EQUAL	3.346	3.937	0.690	85	100	18	29607-5677	GD	3.375	4.000	0.625	86	102	16
24626-2310	26	3.346	4.134	0.500	85	105	13	24627-0813	26	3.375	4.125	0.375	86	105	10
24600-2310	26	3.346	4.134	0.512	85	105	13	24610-0813	26	3.375	4.125	0.375	86	105	10
24802-2523	EQUAL	3.346	4.134	0.625	85	105	16	24807-3767	EQUAL	3.375	4.125	0.690	86	105	18
29502-5701	IG	3.346	4.134	0.750	85	105	19	29502-4385	IG	3.375	4.125	0.750	86	105	19
24802-3045	EQUAL	3.346	4.321	0.625	85	110	16	24600-0839	26	3.375	4.250	0.375	86	108	10
25003-5650	23	3.346	4.330	0.500	85	110	13	25003-7642	23	3.375	4.250	0.500	86	108	13
24802-3161	EQUAL	3.346	4.330	0.625	85	110	16	24803-7642	EQUAL	3.375	4.250	0.500	86	108	13
25003-2214	23	3.346	4.331	0.472	85	110	12	24802-2316	EQUAL	3.375	4.250	0.625	86	108	16
25006-2214	23	3.346	4.331	0.472	85	110	12	29502-6131	IG	3.375	4.250	0.750	86	108	19
25003-2137	23	3.346	4.331	0.492	85	110	12	29516-5272	IG	3.375	4.335	0.990	86	110	25
25003-4806	23	3.346	4.331	0.512	85	110	13	29516-5124	IG	3.375	4.335	1.158	86	110	29
24610-5343	26	3.346	4.331	0.512	85	110	13	24600-1375	26	3.375	4.355	0.375	86	111	10
29519-6702	IG	3.346	4.331	0.625	85	110	16	25003-9056	23	3.375	4.375	0.375	86	111	10
29607-6702	GD	3.346	4.331	0.625	85	110	16	25006-9056	23	3.375	4.375	0.375	86	111	10

All dimensions are in inches. Preferred sizes are indicated with **bold** type face.

Sizes listed are for standard nitrile elements, except Models 25 and 62 which have PTFE elements. Other material available on inquiry only.

## Oil Seals by Model Number

Product Code	Model	Inches			MM			Product Code	Model	Inches			MM		
		ID	OD	Width	ID	OD	Width			ID	OD	Width	ID	OD	Width
25009-9056	23	3.375	4.375	0.375	86	111	10	22987-5332	53F1	3.375	4.750	0.750	86	121	19
25003-4688	23	3.375	4.375	0.438	86	111	11	25003-2333	23	3.375	4.875	0.500	86	124	13
25003-2321	23	3.375	4.375	0.500	86	111	13	21086-2333	53	3.375	4.875	0.500	86	124	13
24626-2321	26	3.375	4.375	0.500	86	111	13	29502-6449	IG	3.375	4.875	0.750	86	124	19
24627-2321	26	3.375	4.375	0.500	86	111	13	24063-2336	61	3.375	4.999	0.500	86	127	13
24600-2321	26	3.375	4.375	0.500	86	111	13	24060-2638	61	3.375	5.000	0.468	86	127	12
24610-2321	26	3.375	4.375	0.500	86	111	13	24600-2319	26	3.375	5.000	0.469	86	127	12
24602-2321	26	3.375	4.375	0.500	86	111	13	21086-2336	53	3.375	5.000	0.500	86	127	13
21086-2321	53	3.375	4.375	0.500	86	111	13	21699-2336	53	3.375	5.000	0.500	86	127	13
21091-2321	53	3.375	4.375	0.500	86	111	13	21702-2336	62	3.375	5.000	0.500	86	127	13
21699-2321	53	3.375	4.375	0.500	86	111	13	21086-2339	53	3.375	5.125	0.500	86	130	13
21702-2321	62	3.375	4.375	0.500	86	111	13	21086-2342	53	3.375	5.250	0.500	86	133	13
24801-2321	EQUAL	3.375	4.375	0.500	86	111	13	29502-4354	IG	3.375	5.250	0.750	86	133	19
25003-9954	23	3.375	4.375	0.515	86	111	13	29502-6298	IG	3.375	5.285	0.750	86	134	19
22502-2323	53G1	3.375	4.375	0.625	86	111	16	24802-3646	EQUAL	3.375	5.290	0.625	86	134	16
21086-2323	53	3.375	4.375	0.625	86	111	16	29602-6577	GD	3.379	4.379	0.700	86	111	18
29507-2322	IG	3.375	4.375	0.625	86	111	16	24807-2973	EQUAL	3.380	4.000	0.690	86	102	18
24801-2322	EQUAL	3.375	4.375	0.625	86	111	16	29602-7473	GD	3.383	4.383	0.700	86	111	18
24802-2322	EQUAL	3.375	4.375	0.625	86	111	16	24802-3101	EQUAL	3.385	4.385	0.625	86	111	16
29602-0774	GD	3.375	4.375	0.700	86	111	18	29500-4748	IG	3.386	5.118	0.750	86	130	19
29502-0774	IG	3.375	4.375	0.750	86	111	19	29500-4750	IG	3.386	5.315	0.750	86	135	19
29503-0774	IG	3.375	4.375	0.750	86	111	19	29502-6699	IG	3.387	4.375	0.750	86	111	19
22897-7357	53T2	3.375	4.375	0.906	86	111	23	29602-6868	GD	3.393	4.393	0.700	86	112	18
29502-5607	IG	3.375	4.400	0.750	86	112	19	29620-7280	GD	3.400	4.200	0.700	86	107	18
29602-6870	GD	3.375	4.407	0.700	86	112	18	24802-3334	EQUAL	3.402	4.375	0.625	86	111	16
25003-4797	23	3.375	4.437	0.375	86	113	10	29602-6811	GD	3.404	4.404	0.700	86	112	18
24824-3082	EQUAL	3.375	4.438	0.625	86	113	16	25010-3411	23	3.407	4.407	0.500	87	112	13
25003-9614	23	3.375	4.500	0.375	86	114	10	29602-6706	GD	3.407	4.407	0.700	87	112	18
25003-2975	23	3.375	4.500	0.438	86	114	11	29502-6675	IG	3.408	4.355	0.750	87	111	19
24664-5387	26HR	3.375	4.500	0.438	86	114	11	29602-6833	GD	3.408	4.408	0.700	87	112	18
25003-2324	23	3.375	4.500	0.500	86	114	13	24802-2332	EQUAL	3.408	4.500	0.625	87	114	16
25006-2324	23	3.375	4.500	0.500	86	114	13	29602-6834	GD	3.412	4.412	0.700	87	112	18
25004-2324	23	3.375	4.500	0.500	86	114	13	29602-6626	GD	3.418	4.418	0.700	87	112	18
24600-2324	26	3.375	4.500	0.500	86	114	13	29502-5133	IG	3.420	4.375	0.750	87	111	19
21087-2324	53	3.375	4.500	0.500	86	114	13	29502-5755	IG	3.420	4.420	0.750	87	112	19
21557-2324	53	3.375	4.500	0.500	86	114	13	29502-4603	IG	3.420	4.500	0.750	87	114	19
21086-2324	53	3.375	4.500	0.500	86	114	13	29602-6823	GD	3.425	4.449	0.700	87	113	18
21095-2324	53	3.375	4.500	0.500	86	114	13	29602-7304	GD	3.425	4.500	0.700	87	114	18
21947-2324	53	3.375	4.500	0.500	86	114	13	24600-4224	26	3.425	4.685	0.492	87	119	12
24060-2324	61	3.375	4.500	0.500	86	114	13	29521-5954	IG	3.427	4.999	0.875	87	127	22
21086-2326	53	3.375	4.500	0.625	86	114	16	21332-2749	143	3.430	4.130	0.610	87	105	15
24801-2326	EQUAL	3.375	4.500	0.625	86	114	16	25003-1087	23	3.430	4.625	0.458	87	117	12
24802-2326	EQUAL	3.375	4.500	0.625	86	114	16	24626-4710	26	3.435	5.000	0.500	87	127	13
29602-4379	GD	3.375	4.500	0.700	86	114	18	24600-4710	26	3.435	5.000	0.500	87	127	13
22987-7289	53F1	3.375	4.500	0.719	86	114	18	25003-7438	23	3.437	4.437	0.437	87	113	11
29500-4379	IG	3.375	4.500	0.750	86	114	19	29502-4288	IG	3.437	4.437	0.750	87	113	19
29502-4379	IG	3.375	4.500	0.750	86	114	19	25003-0996	23	3.437	4.500	0.375	87	114	10
29602-6621	GD	3.375	4.525	0.700	86	115	18	25003-1440	23	3.437	4.500	0.437	87	114	11
25003-2327	23	3.375	4.625	0.500	86	117	13	25006-1440	23	3.437	4.500	0.437	87	114	11
21086-2327	53	3.375	4.625	0.500	86	117	13	24060-1440	61	3.437	4.500	0.437	87	114	11
21702-2327	62	3.375	4.625	0.500	86	117	13	24610-9137	26	3.437	4.500	0.438	87	114	11
21086-2329	53	3.375	4.625	0.625	86	117	16	24626-2345	26	3.437	4.500	0.500	87	114	13
29502-5058	IG	3.375	4.625	0.750	86	117	19	24600-2345	26	3.437	4.500	0.500	87	114	13
21086-7868	53	3.375	4.724	0.500	86	120	13	24610-2345	26	3.437	4.500	0.500	87	114	13
25003-2330	23	3.375	4.750	0.500	86	121	13	21699-2345	53	3.437	4.500	0.500	87	114	13
21086-2330	53	3.375	4.750	0.500	86	121	13	22500-2595	53G1	3.437	4.500	0.625	87	114	16

All dimensions are in inches. Preferred sizes are indicated with **bold** type face. Sizes listed are for standard nitrile elements, except Models 25 and 62 which have PTFE elements. Other material available on inquiry only.

## Oil Seals by Model Number

Product Code	Model	Inches			MM			Product Code	Model	Inches			MM		
		ID	OD	Width	ID	OD	Width			ID	OD	Width	ID	OD	Width
24801-1911	EQUAL	3.437	4.500	0.625	87	114	16	25006-2348	23	3.438	4.625	0.500	87	117	13
24802-1911	EQUAL	3.437	4.500	0.625	87	114	16	25004-2348	23	3.438	4.625	0.500	87	117	13
22537-5183	53R1	3.437	4.500	0.906	87	114	23	24600-2348	26	3.438	4.625	0.500	87	117	13
22627-5183	53R2	3.437	4.500	0.906	87	114	23	21096-2348	53	3.438	4.625	0.500	87	117	13
23708-5183	53R2	3.437	4.500	0.906	87	114	23	21086-2348	53	3.438	4.625	0.500	87	117	13
24816-7147	EQUAL	3.437	4.523	1.312	87	115	33	24801-2335	EQUAL	3.438	4.625	0.625	87	117	16
24060-2348	61	3.437	4.625	0.500	87	117	13	24802-2335	EQUAL	3.438	4.626	0.625	87	118	16
21702-2348	62	3.437	4.625	0.500	87	117	13	25003-6357	23	3.438	4.688	0.500	87	119	13
24610-3471	26	3.437	4.688	0.500	87	119	13	21086-7960	53	3.438	4.724	0.500	87	120	13
21699-2351	53	3.437	4.750	0.500	87	121	13	25003-2351	23	3.438	4.750	0.500	87	121	13
21086-2353	53	3.437	4.750	0.625	87	121	16	21086-2351	53	3.438	4.750	0.500	87	121	13
25003-2943	23	3.437	4.875	0.437	87	124	11	21086-2354	53	3.438	4.875	0.500	87	124	13
21699-2356	53	3.437	4.875	0.625	87	124	16	24626-2356	26	3.438	4.875	0.625	87	124	16
25003-4710	23	3.437	5.000	0.500	87	127	13	24600-2356	26	3.438	4.875	0.625	87	124	16
21095-2360	53	3.437	5.125	0.500	87	130	13	21086-2356	53	3.438	4.875	0.625	87	124	16
21086-2362	53	3.437	5.125	0.625	87	130	16	22987-6159	53F1	3.438	4.875	0.719	87	124	18
24802-3753	EQUAL	3.437	5.125	0.625	87	130	16	25284-9944	23	3.438	4.937	0.500	87	125	13
21086-2365	53	3.437	5.250	0.625	87	133	16	25003-9944	23	3.438	4.938	0.500	87	125	13
29516-7116	IG	3.437	5.807	0.806	87	147	20	25009-9944	23	3.438	4.938	0.500	87	125	13
24829-2344	EQUAL	3.438	4.188	0.625	87	106	16	21699-2357	53	3.438	4.999	0.500	87	127	13
24824-2344	EQUAL	3.438	4.190	0.625	87	106	16	21086-2357	53	3.438	5.000	0.500	87	127	13
29502-6392	IG	3.438	4.250	0.750	87	108	19	21095-2357	53	3.438	5.000	0.500	87	127	13
24802-3344	EQUAL	3.438	4.313	0.625	87	110	16	29502-5592	IG	3.438	5.000	0.750	87	127	19
29516-7086	IG	3.438	4.333	0.956	87	110	24	21086-2360	53	3.438	5.125	0.500	87	130	13
24816-7033	EQUAL	3.438	4.338	1.375	87	110	35	21086-2363	53	3.438	5.250	0.500	87	133	13
25284-7075	23	3.438	4.438	0.375	87	113	10	29602-7441	GD	3.440	4.520	0.700	87	115	18
25003-7075	23	3.438	4.438	0.375	87	113	10	29502-6239	IG	3.442	4.375	0.750	87	111	19
25004-7075	23	3.438	4.438	0.375	87	113	10	24802-2944	EQUAL	3.450	4.500	0.625	88	114	16
25009-7075	23	3.438	4.438	0.375	87	113	10	29608-6769	GD	3.460	4.331	0.625	88	110	16
25045-6355	23	3.438	4.438	0.500	87	113	13	25003-3828	23	3.460	4.500	0.500	88	114	13
25003-6355	23	3.438	4.438	0.500	87	113	13	25003-1772	23	3.464	4.331	0.500	88	110	13
24801-2577	EQUAL	3.438	4.438	0.625	87	113	16	29502-5090	IG	3.464	4.500	0.750	88	114	19
24802-2577	EQUAL	3.438	4.438	0.625	87	113	16	29502-6323	IG	3.465	4.331	0.750	88	110	19
24829-2577	EQUAL	3.438	4.438	0.625	87	113	16	25003-1768	23	3.465	4.729	0.500	88	120	13
24816-7025	EQUAL	3.438	4.458	1.313	87	113	33	29502-5941	IG	3.465	5.512	0.750	88	140	19
29502-5002	IG	3.438	4.460	0.750	87	113	19	25003-9015	23	3.469	4.500	0.500	88	114	13
29516-7112	IG	3.438	4.460	0.994	87	113	25	25006-9015	23	3.469	4.500	0.500	88	114	13
29598-0010	IG	3.438	4.460	0.994	87	113	25	25003-3336	23	3.470	4.470	0.375	88	114	10
29616-7112	GD	3.438	4.460	1.297	87	113	33	29602-6974	GD	3.472	4.472	0.700	88	114	18
24816-7138	EQUAL	3.438	4.460	1.375	87	113	35	29602-6755	GD	3.476	4.476	0.700	88	114	18
25003-2345	23	3.438	4.500	0.500	87	114	13	29519-6609	IG	3.483	4.506	0.625	88	114	16
21096-2345	53	3.438	4.500	0.500	87	114	13	29619-6609	GD	3.483	4.506	0.625	88	114	16
21087-2345	53	3.438	4.500	0.500	87	114	13	26001-7095	71	3.500	3.875	0.188	89	98	5
21557-2345	53	3.438	4.500	0.500	87	114	13	26001-7096	71	3.500	4.003	0.250	89	102	6
21086-2345	53	3.438	4.500	0.500	87	114	13	26001-9668	71	3.500	4.062	0.109	89	103	3
24060-2345	61	3.438	4.500	0.500	87	114	13	29507-4893	IG	3.500	4.125	0.625	89	105	16
21767-2345	62	3.438	4.500	0.500	87	114	13	24610-3226	26	3.500	4.250	0.438	89	108	11
21702-2345	62	3.438	4.500	0.500	87	114	13	24060-1599	61	3.500	4.250	0.500	89	108	13
24833-1911	EQUAL	3.438	4.500	0.625	87	114	16	29516-7114	IG	3.500	4.333	1.035	89	110	26
29602-4650	GD	3.438	4.500	0.700	87	114	18	25009-2364	23	3.500	4.375	0.375	89	111	10
29502-4650	IG	3.438	4.500	0.750	87	114	19	25003-2364	23	3.500	4.375	0.375	89	111	10
22987-5319	53F1	3.438	4.500	0.875	87	114	22	25006-2364	23	3.500	4.375	0.375	89	111	10
29519-6630	IG	3.438	4.506	0.625	87	114	16	24626-2364	26	3.500	4.375	0.375	89	111	10
29516-7113	IG	3.438	4.523	1.050	87	115	27	24600-2364	26	3.500	4.375	0.375	89	111	10
25010-2348	23	3.438	4.625	0.500	87	117	13	24610-2364	26	3.500	4.375	0.375	89	111	10
25003-2348	23	3.438	4.625	0.500	87	117	13	25010-6285	23	3.500	4.375	0.500	89	111	13

All dimensions are in inches. Preferred sizes are indicated with **bold** type face.

Sizes listed are for standard nitrile elements, except Models 25 and 62 which have PTFE elements. Other material available on inquiry only.

## Oil Seals by Model Number

Product Code	Model	Inches			MM			Product Code	Model	Inches			MM		
		ID	OD	Width	ID	OD	Width			ID	OD	Width	ID	OD	Width
25003-6285	23	3.500	4.375	0.500	89	111	13	21527-2366	66	3.500	4.500	0.500	89	114	13
25006-6285	23	3.500	4.375	0.500	89	111	13	24801-2366	EQUAL	3.500	4.500	0.500	89	114	13
25004-6285	23	3.500	4.375	0.500	89	111	13	21086-2367	53	3.500	4.500	0.563	89	114	14
25059-6285	25	3.500	4.375	0.500	89	111	13	21702-2367	62	3.500	4.500	0.563	89	114	14
24610-0718	26	3.500	4.375	0.500	89	111	13	24600-2368	26	3.500	4.500	0.625	89	114	16
24060-6285	61	3.500	4.375	0.500	89	111	13	24626-2368	26	3.500	4.500	0.625	89	114	16
24801-2378	EQUAL	3.500	4.375	0.625	89	111	16	21086-2368	53	3.500	4.500	0.625	89	114	16
24802-2378	EQUAL	3.500	4.375	0.625	89	111	16	21095-2368	53	3.500	4.500	0.625	89	114	16
29602-4214	GD	3.500	4.375	0.700	89	111	18	29519-2368	IG	3.500	4.500	0.625	89	114	16
29500-4214	IG	3.500	4.375	0.750	89	111	19	24801-2368	EQUAL	3.500	4.500	0.625	89	114	16
29502-4214	IG	3.500	4.375	0.750	89	111	19	24802-2368	EQUAL	3.500	4.500	0.625	89	114	16
29500-5700	IG	3.500	4.381	0.750	89	111	19	24803-2368	EQUAL	3.500	4.500	0.625	89	114	16
25001-6559	21	3.500	4.390	0.336	89	112	9	24822-2368	EQUAL	3.500	4.500	0.625	89	114	16
25003-1296	23	3.500	4.437	0.500	89	113	13	24824-2368	EQUAL	3.500	4.500	0.625	89	114	16
24600-3981	26	3.500	4.438	0.313	89	113	8	24829-2368	EQUAL	3.500	4.500	0.625	89	114	16
24816-7036	EQUAL	3.500	4.458	1.313	89	113	33	29602-4156	GD	3.500	4.500	0.700	89	114	18
29516-7182	IG	3.500	4.460	0.988	89	113	25	22987-7115	53F1	3.500	4.500	0.719	89	114	18
25003-1444	23	3.500	4.475	0.500	89	114	13	29500-4156	IG	3.500	4.500	0.750	89	114	19
29502-6869	IG	3.500	4.480	0.750	89	114	19	29502-4156	IG	3.500	4.500	0.750	89	114	19
25009-6358	23	3.500	4.500	0.375	89	114	10	29503-4156	IG	3.500	4.500	0.750	89	114	19
25010-6358	23	3.500	4.500	0.375	89	114	10	29522-4156	IG	3.500	4.500	0.750	89	114	19
25003-6358	23	3.500	4.500	0.375	89	114	10	22537-5300	53R1	3.500	4.500	0.813	89	114	21
25006-6358	23	3.500	4.500	0.375	89	114	10	29518-6318	IG	3.500	4.500	0.875	89	114	22
25004-6358	23	3.500	4.500	0.375	89	114	10	22537-6534	53R1	3.500	4.500	0.906	89	114	23
25003-2298	23	3.500	4.500	0.438	89	114	11	22627-6534	53R2	3.500	4.500	0.906	89	114	23
24626-2377	26	3.500	4.500	0.438	89	114	11	22897-6534	53T2	3.500	4.500	0.906	89	114	23
24600-2377	26	3.500	4.500	0.438	89	114	11	25003-3074	23	3.500	4.501	0.468	89	114	12
24610-2377	26	3.500	4.500	0.438	89	114	11	29516-7097	IG	3.500	4.523	1.050	89	115	27
24612-2377	26	3.500	4.500	0.438	89	114	11	29519-6321	IG	3.500	4.563	0.625	89	116	16
25003-4640	23	3.500	4.500	0.469	89	114	12	25003-5122	23	3.500	4.625	0.375	89	117	10
21481-4640	66	3.500	4.500	0.469	89	114	12	25003-2369	23	3.500	4.625	0.500	89	117	13
25087-2366	23	3.500	4.500	0.500	89	114	13	21086-2369	53	3.500	4.625	0.500	89	117	13
25003-2366	23	3.500	4.500	0.500	89	114	13	21947-2369	53	3.500	4.625	0.500	89	117	13
25006-2366	23	3.500	4.500	0.500	89	114	13	21086-2370	53	3.500	4.625	0.563	89	117	14
25009-2366	23	3.500	4.500	0.500	89	114	13	24802-1882	EQUAL	3.500	4.625	0.625	89	117	16
25058-2366	25	3.500	4.500	0.500	89	114	13	29602-4576	GD	3.500	4.625	0.700	89	117	18
24627-2366	26	3.500	4.500	0.500	89	114	13	29502-4576	IG	3.500	4.625	0.750	89	117	19
24600-2366	26	3.500	4.500	0.500	89	114	13	25003-3439	23	3.500	4.631	0.500	89	118	13
24610-2366	26	3.500	4.500	0.500	89	114	13	24620-2862	26R1	3.500	4.721	0.375	89	120	10
24602-2366	26	3.500	4.500	0.500	89	114	13	29502-5933	IG	3.500	4.721	0.750	89	120	19
24626-2366	26	3.500	4.500	0.500	89	114	13	25003-7578	23	3.500	4.750	0.375	89	121	10
21096-2366	53	3.500	4.500	0.500	89	114	13	24627-3374	26	3.500	4.750	0.438	89	121	11
21087-2366	53	3.500	4.500	0.500	89	114	13	24610-3374	26	3.500	4.750	0.438	89	121	11
21597-2366	53	3.500	4.500	0.500	89	114	13	25003-2372	23	3.500	4.750	0.500	89	121	13
21086-2366	53	3.500	4.500	0.500	89	114	13	25006-2372	23	3.500	4.750	0.500	89	121	13
21095-2366	53	3.500	4.500	0.500	89	114	13	24627-0920	26	3.500	4.750	0.500	89	121	13
21947-2366	53	3.500	4.500	0.500	89	114	13	24610-0920	26	3.500	4.750	0.500	89	121	13
21409-2366	53	3.500	4.500	0.500	89	114	13	24612-0920	26	3.500	4.750	0.500	89	121	13
21699-2366	53	3.500	4.500	0.500	89	114	13	21087-2372	53	3.500	4.750	0.500	89	121	13
24062-2366	61	3.500	4.500	0.500	89	114	13	21597-2372	53	3.500	4.750	0.500	89	121	13
24126-2366	61	3.500	4.500	0.500	89	114	13	21086-2372	53	3.500	4.750	0.500	89	121	13
24064-2366	61	3.500	4.500	0.500	89	114	13	21098-2372	53	3.500	4.750	0.500	89	121	13
24060-2366	61	3.500	4.500	0.500	89	114	13	21699-2372	53	3.500	4.750	0.500	89	121	13
21767-2366	62	3.500	4.500	0.500	89	114	13	21702-2372	62	3.500	4.750	0.500	89	121	13
21702-2366	62	3.500	4.500	0.500	89	114	13	21455-2372	66	3.500	4.750	0.500	89	121	13
21481-2366	66	3.500	4.500	0.500	89	114	13	24610-2374	26	3.500	4.750	0.625	89	121	16

All dimensions are in inches. Preferred sizes are indicated with **bold** type face. Sizes listed are for standard nitrile elements, except Models 25 and 62 which have PTFE elements. Other material available on inquiry only.

## Oil Seals by Model Number

Product Code	Model	Inches			MM			Product Code	Model	Inches			MM		
		ID	OD	Width	ID	OD	Width			ID	OD	Width	ID	OD	Width
21086-2374	53	3.500	4.750	0.625	89	121	16	29502-5749	IG	3.535	4.535	0.750	90	115	19
24801-2374	EQUAL	3.500	4.750	0.625	89	121	16	24802-5986	EQUAL	3.535	5.625	0.625	90	143	16
24802-2374	EQUAL	3.500	4.750	0.625	89	121	16	29502-6487	IG	3.536	5.375	0.750	90	137	19
24829-2374	EQUAL	3.500	4.750	0.625	89	121	16	24600-1968	26	3.537	4.500	0.500	90	114	13
29602-6408	GD	3.500	4.750	0.700	89	121	18	29602-6993	GD	3.538	4.538	0.700	90	115	18
29500-6408	IG	3.500	4.750	0.750	89	121	19	29602-5748	GD	3.540	4.540	0.700	90	115	18
29502-6408	IG	3.500	4.750	0.750	89	121	19	29502-5748	IG	3.540	4.540	0.750	90	115	19
22537-7269	53R1	3.500	4.750	0.844	89	121	21	25003-5100	23	3.542	4.542	0.375	90	115	10
25003-1034	23	3.500	4.813	0.500	89	122	13	25006-5100	23	3.542	4.542	0.375	90	115	10
21086-2375	53	3.500	4.875	0.500	89	124	13	29602-6960	GD	3.542	4.542	0.700	90	115	18
24802-5461	EQUAL	3.500	4.875	0.625	89	124	16	29507-6610	IG	3.543	4.250	0.625	90	108	16
22537-7611	53R1	3.500	4.875	0.969	89	124	25	24629-2437	26R1	3.543	4.330	0.472	90	110	12
22897-7611	53T2	3.500	4.875	0.969	89	124	25	24600-5002	26	3.543	4.330	0.500	90	110	13
21086-8877	53	3.500	4.921	0.562	89	125	14	24626-5002	26	3.543	4.330	0.511	90	110	13
21087-2378	53	3.500	4.999	0.500	89	127	13	24064-1856	61	3.543	4.331	0.394	90	110	10
21086-2378	53	3.500	4.999	0.500	89	127	13	24060-1856	61	3.543	4.331	0.394	90	110	10
21091-2380	53	3.500	4.999	0.625	89	127	16	24602-2437	26	3.543	4.331	0.472	90	110	12
25003-4745	23	3.500	5.000	0.375	89	127	10	29519-3265	IG	3.543	4.331	0.625	90	110	16
25003-7253	23	3.500	5.000	0.500	89	127	13	24802-3265	EQUAL	3.543	4.331	0.625	90	110	16
24627-0922	26	3.500	5.000	0.500	89	127	13	29500-4976	IG	3.543	4.331	0.750	90	110	19
24610-0922	26	3.500	5.000	0.500	89	127	13	24802-1815	EQUAL	3.543	4.500	0.625	90	114	16
21096-2378	53	3.500	5.000	0.500	89	127	13	25003-8803	23	3.543	4.527	0.491	90	115	12
21095-2378	53	3.500	5.000	0.500	89	127	13	25003-4846	23	3.543	4.527	0.500	90	115	13
21086-7253	53	3.500	5.000	0.500	89	127	13	24620-5344	26R1	3.543	4.527	0.512	90	115	13
24803-3764	EQUAL	3.500	5.000	0.625	89	127	16	25003-9963	23	3.543	4.528	0.472	90	115	12
29602-9186	GD	3.500	5.000	0.700	89	127	18	24638-9963	26	3.543	4.528	.472	90	115	12
22627-7324	53R2	3.500	5.000	0.906	89	127	23	24610-5344	26	3.543	4.528	0.512	90	115	13
22634-7324	53R2	3.500	5.000	0.906	89	127	23	29500-5962	IG	3.543	4.528	0.750	90	115	19
21086-2381	53	3.500	5.125	0.500	89	130	13	29502-5962	IG	3.543	4.528	0.750	90	115	19
29604-6090	GD	3.500	5.125	0.700	89	130	18	29507-2405	IG	3.543	4.543	0.625	90	115	16
29502-6090	IG	3.500	5.125	0.750	89	130	19	29602-5479	GD	3.543	4.543	0.700	90	115	18
21096-2384	53	3.500	5.250	0.500	89	133	13	29500-5479	IG	3.543	4.543	0.750	90	115	19
21086-2384	53	3.500	5.250	0.500	89	133	13	29502-5479	IG	3.543	4.543	0.750	90	115	19
21699-2384	53	3.500	5.250	0.500	89	133	13	29502-6739	IG	3.543	4.563	0.750	90	116	19
21003-2384	58	3.500	5.250	0.500	89	133	13	29519-3119	IG	3.543	4.567	0.625	90	116	16
21086-2386	53	3.500	5.250	0.625	89	133	16	29502-6493	IG	3.543	4.567	0.750	90	116	19
29502-5381	IG	3.500	5.250	0.750	89	133	19	29502-6213	IG	3.543	4.575	0.750	90	116	19
21087-2387	53	3.500	5.375	0.500	89	137	13	25003-7839	23	3.543	4.724	0.472	90	120	12
21086-2387	53	3.500	5.375	0.500	89	137	13	21087-7839	53	3.543	4.724	0.472	90	120	12
21699-2387	53	3.500	5.375	0.500	89	137	13	21086-7839	53	3.543	4.724	0.472	90	120	12
21086-2390	53	3.500	5.500	0.500	89	140	13	25010-8429	23	3.543	4.724	0.500	90	120	13
21699-2390	53	3.500	5.500	0.500	89	140	13	25003-8429	23	3.543	4.724	0.500	90	120	13
21088-2392	53	3.500	5.500	0.625	89	140	16	21086-8429	53	3.543	4.724	0.500	90	120	13
21086-2392	53	3.500	5.500	0.625	89	140	16	21699-8429	53	3.543	4.724	0.500	90	120	13
29602-6756	GD	3.507	4.507	0.700	89	114	18	24626-2457	26	3.543	4.724	0.511	90	120	13
29602-6802	GD	3.512	4.750	0.700	89	121	18	24600-2457	26	3.543	4.724	0.511	90	120	13
24610-6011	26	3.514	4.500	0.512	89	114	13	24801-2902	EQUAL	3.543	4.724	0.625	90	120	16
29507-5981	IG	3.520	4.520	0.625	89	115	16	24802-2902	EQUAL	3.543	4.724	0.625	90	120	16
24802-4136	EQUAL	3.522	4.500	0.625	89	114	16	29602-4758	GD	3.543	4.724	0.700	90	120	18
24822-4136	EQUAL	3.523	4.500	0.625	89	114	16	29500-4758	IG	3.543	4.724	0.750	90	120	19
29602-2365	GD	3.523	4.523	0.700	89	115	18	29502-4758	IG	3.543	4.724	0.750	90	120	19
24802-2261	EQUAL	3.526	4.526	0.625	90	115	16	29500-4844	IG	3.543	4.960	0.750	90	126	19
29602-5682	GD	3.526	4.526	0.700	90	115	18	24610-7310	26	3.543	5.118	0.630	90	130	16
29502-6979	IG	3.529	4.300	0.750	90	109	19	29502-6647	IG	3.543	5.629	0.750	90	143	19
29502-6976	IG	3.529	4.562	0.750	90	116	19	29516-7162	IG	3.543	5.807	0.806	90	147	20
29502-4491	IG	3.535	4.500	0.750	90	114	19	24125-1856	61	3.543	4.331	0.394	90	110	10

All dimensions are in inches. Preferred sizes are indicated with **bold** type face.

Sizes listed are for standard nitrile elements, except Models 25 and 62 which have PTFE elements. Other material available on inquiry only.



## Oil Seals by Model Number

Product Code	Model	Inches			MM			Product Code	Model	Inches			MM		
		ID	OD	Width	ID	OD	Width			ID	OD	Width	ID	OD	Width
24063-1856	61	3.543	4.331	0.394	90	110	10	29502-5314	IG	3.580	4.916	0.750	91	125	19
24062-1856	61	3.543	4.331	0.394	90	110	10	29502-5658	IG	3.600	4.600	0.750	91	117	19
24128-1856	61	3.543	4.331	0.394	90	110	10	24802-2527	EQUAL	3.600	5.000	0.625	91	127	16
24620-2437	26R1	3.543	4.331	0.472	90	110	12	29502-5210	IG	3.605	4.625	0.750	92	117	19
24060-0879	61	3.543	4.331	0.472	90	110	12	24610-5315	26	3.621	4.606	0.512	92	117	13
24610-5002	26	3.543	4.331	0.512	90	110	13	29502-6302	IG	3.622	4.724	0.750	92	120	19
24060-9963	61	3.543	4.528	0.472	90	115	12	24064-1605	61	3.625	4.250	0.312	92	108	8
24600-5344	26	3.543	4.528	0.512	90	115	13	24802-1080	EQUAL	3.625	4.375	0.625	92	111	16
24602-7839	26	3.543	4.724	0.472	90	120	12	24822-1080	EQUAL	3.625	4.375	0.625	92	111	16
24060-7839	61	3.543	4.724	0.472	90	120	12	29609-6957	GD	3.625	4.376	0.375	92	111	10
24610-2457	26	3.543	4.724	0.512	90	120	13	24801-1751	EQUAL	3.625	4.499	0.469	92	114	12
24802-5382	EQUAL	3.544	4.565	0.625	90	116	16	25003-5313	23	3.625	4.500	0.500	92	114	13
29519-7303	IG	3.545	4.500	0.640	90	114	16	29502-6150	IG	3.625	4.500	0.750	92	114	19
29502-6495	IG	3.545	4.565	0.750	90	116	19	25135-1515	23	3.625	4.609	0.492	92	117	12
29502-4715	IG	3.550	4.550	0.750	90	116	19	25003-1515	23	3.625	4.609	0.492	92	117	12
29502-6636	IG	3.553	5.624	0.750	90	143	19	25006-1515	23	3.625	4.609	0.492	92	117	12
29602-6849	GD	3.558	4.500	0.700	90	114	18	25009-6359	23	3.625	4.625	0.375	92	117	10
29602-7425	GD	3.558	4.750	0.700	90	121	18	25003-6359	23	3.625	4.625	0.375	92	117	10
29507-6824	IG	3.560	4.125	0.625	90	105	16	24627-6334	26	3.625	4.625	0.375	92	117	10
29608-6824	GD	3.560	4.125	0.625	90	105	16	25003-1022	23	3.625	4.625	0.437	92	117	11
29602-7249	GD	3.560	4.310	0.700	90	109	18	25003-2417	23	3.625	4.625	0.500	92	117	13
25003-3827	23	3.561	4.560	0.500	90	116	13	24626-2417	26	3.625	4.625	0.500	92	117	13
29502-6306	IG	3.562	4.481	0.750	90	114	19	24627-2417	26	3.625	4.625	0.500	92	117	13
24700-3240	59	3.562	4.500	0.625	90	114	16	24600-2417	26	3.625	4.625	0.500	92	117	13
24802-5449	EQUAL	3.562	4.625	0.625	90	117	16	24610-2417	26	3.625	4.625	0.500	92	117	13
22897-6545	53T2	3.562	4.625	0.906	90	117	23	21086-2417	53	3.625	4.625	0.500	92	117	13
21699-2396	53	3.562	4.750	0.500	90	121	13	21409-2417	53	3.625	4.625	0.500	92	117	13
25003-5933	23	3.562	4.812	0.500	90	122	13	21699-2417	53	3.625	4.625	0.500	92	117	13
21702-2408	62	3.562	5.250	0.500	90	133	13	21003-2417	58	3.625	4.625	0.500	92	117	13
25003-1029	23	3.563	4.500	0.469	91	114	12	21702-2417	62	3.625	4.625	0.500	92	117	13
24060-1604	61	3.563	4.500	0.500	91	114	13	22502-2419	53G1	3.625	4.625	0.625	92	117	16
24802-3240	EQUAL	3.563	4.500	0.625	91	114	16	21086-2419	53	3.625	4.625	0.625	92	117	16
29602-5165	GD	3.563	4.500	0.700	91	114	18	29519-2419	IG	3.625	4.625	0.625	92	117	16
29502-5165	IG	3.563	4.500	0.750	91	114	19	24801-2419	EQUAL	3.625	4.625	0.625	92	117	16
25003-1988	23	3.563	4.563	0.375	91	116	10	24802-2419	EQUAL	3.625	4.625	0.625	92	117	16
25003-5051	23	3.563	4.563	0.500	91	116	13	24806-2419	EQUAL	3.625	4.625	0.625	92	117	16
29602-4289	GD	3.563	4.563	0.700	91	116	18	29602-4157	GD	3.625	4.625	0.700	92	117	18
29502-4289	IG	3.563	4.563	0.750	91	116	19	22987-6590	53F1	3.625	4.625	0.719	92	117	18
25003-6923	23	3.563	4.625	0.375	91	117	10	29502-4157	IG	3.625	4.625	0.750	92	117	19
25003-2393	23	3.563	4.625	0.500	91	117	13	22627-6901	53R2	3.625	4.625	0.906	92	117	23
24610-2213	26	3.563	4.625	0.500	91	117	13	25003-7968	23	3.625	4.724	0.500	92	120	13
21086-2393	53	3.563	4.625	0.500	91	117	13	21086-7968	53	3.625	4.724	0.500	92	120	13
21702-2393	62	3.563	4.625	0.500	91	117	13	25003-0692	23	3.625	4.750	0.375	92	121	10
22627-6545	53R2	3.563	4.625	0.906	91	117	23	25003-2420	23	3.625	4.750	0.500	92	121	13
25003-2396	23	3.563	4.750	0.500	91	121	13	21096-2420	53	3.625	4.750	0.500	92	121	13
21086-2396	53	3.563	4.750	0.500	91	121	13	21088-2420	53	3.625	4.750	0.500	92	121	13
29502-6075	IG	3.563	4.750	0.750	91	121	19	21086-2420	53	3.625	4.750	0.500	92	121	13
24802-1174	EQUAL	3.563	4.751	0.625	91	121	16	21699-2420	53	3.625	4.750	0.500	92	121	13
21086-2399	53	3.563	4.875	0.500	91	124	13	24060-2420	61	3.625	4.750	0.500	92	121	13
21086-2402	53	3.563	5.000	0.500	91	127	13	21088-2421	53	3.625	4.750	0.563	92	121	14
21095-2402	53	3.563	5.000	0.500	91	127	13	24600-2412	26	3.625	4.750	0.625	92	121	16
21086-2408	53	3.563	5.250	0.500	91	133	13	22537-8396	53R1	3.625	4.750	0.906	92	121	23
22537-7905	53R1	3.563	5.250	0.906	91	133	23	22627-8396	53R2	3.625	4.750	0.906	92	121	23
21140-6008	54	3.563	7.250	0.563	91	184	14	29516-7210	IG	3.625	4.773	1.158	92	121	29
29502-6464	IG	3.565	4.565	0.750	91	116	19	25003-3758	23	3.625	4.839	0.500	92	123	13
29519-6166	IG	3.571	4.534	0.625	91	115	16	25003-4864	23	3.625	4.875	0.375	92	124	10

All dimensions are in inches. Preferred sizes are indicated with **bold** type face.

Sizes listed are for standard nitrile elements, except Models 25 and 62 which have PTFE elements. Other material available on inquiry only.

## Oil Seals by Model Number

Product Code	Model	Inches			MM			Product Code	Model	Inches			MM		
		ID	OD	Width	ID	OD	Width			ID	OD	Width	ID	OD	Width
25003-2423	23	3.625	4.875	0.500	92	124	13	24610-5092	26	3.688	4.813	0.468	94	122	12
24627-0923	26	3.625	4.875	0.500	92	124	13	25003-2444	23	3.688	4.875	0.500	94	124	13
21087-2423	53	3.625	4.875	0.500	92	124	13	21086-2444	53	3.688	4.875	0.500	94	124	13
21086-2423	53	3.625	4.875	0.500	92	124	13	21947-2444	53	3.688	4.875	0.500	94	124	13
21095-2423	53	3.625	4.875	0.500	92	124	13	25003-8159	23	3.688	4.938	0.500	94	125	13
21699-2423	53	3.625	4.875	0.500	92	124	13	24626-2447	26	3.688	4.999	0.500	94	127	13
21086-2424	53	3.625	4.875	0.562	92	124	14	24600-2447	26	3.688	4.999	0.500	94	127	13
21086-2425	53	3.625	4.875	0.625	92	124	16	25003-5097	23	3.688	5.000	0.500	94	127	13
25003-2415	23	3.625	5.000	0.500	92	127	13	21086-2447	53	3.688	5.000	0.500	94	127	13
25003-2426	23	3.625	5.000	0.500	92	127	13	21699-2447	53	3.688	5.000	0.500	94	127	13
24627-2415	26	3.625	5.000	0.500	92	127	13	21086-2450	53	3.688	5.125	0.500	94	130	13
24610-2415	26	3.625	5.000	0.500	92	127	13	21095-2450	53	3.688	5.125	0.500	94	130	13
21087-2426	53	3.625	5.000	0.500	92	127	13	21699-2450	53	3.688	5.125	0.500	94	130	13
21597-2426	53	3.625	5.000	0.500	92	127	13	21086-2453	53	3.688	5.250	0.500	94	133	13
21086-2426	53	3.625	5.000	0.500	92	127	13	22987-8531	53F1	3.688	5.250	0.781	94	133	20
21086-5582	53	3.625	5.000	0.563	92	127	14	21086-2459	53	3.688	5.500	0.500	94	140	13
25003-2429	23	3.625	5.125	0.500	92	130	13	29602-6955	GD	3.701	4.469	0.700	94	114	18
21086-2429	53	3.625	5.125	0.500	92	130	13	25003-9547	23	3.712	4.712	0.500	94	120	13
24620-2432	26R1	3.625	5.250	0.500	92	133	13	24662-5566	26HR	3.713	4.972	0.492	94	126	12
24608-2432	26R1	3.625	5.250	0.500	92	133	13	24626-5566	26	3.713	4.972	0.492	94	126	12
24600-2432	26	3.625	5.250	0.500	92	133	13	25003-4807	23	3.715	4.750	0.515	94	121	13
24610-2432	26	3.625	5.250	0.500	92	133	13	25003-4742	23	3.719	5.094	0.500	94	129	13
21086-2432	53	3.625	5.250	0.500	92	133	13	25003-1041	23	3.720	4.720	0.500	94	120	13
21699-2432	53	3.625	5.250	0.500	92	133	13	25284-1041	23	3.720	4.720	0.500	94	120	13
21086-2435	53	3.625	5.375	0.500	92	137	13	29502-5730	IG	3.725	4.725	0.750	95	120	19
21086-2438	53	3.625	5.500	0.500	92	140	13	29602-7254	GD	3.730	4.730	0.700	95	120	18
22897-6505	53T2	3.625	5.500	0.969	92	140	25	29602-5057	GD	3.731	4.731	0.700	95	120	18
29502-5296	IG	3.634	4.625	0.750	92	117	19	29502-5057	IG	3.731	4.731	0.750	95	120	19
29619-7259	GD	3.655	4.405	0.625	93	112	16	24802-3072	EQUAL	3.735	4.735	0.625	95	120	16
25003-1901	23	3.681	4.681	0.500	93	119	13	29502-6532	IG	3.738	4.761	0.750	95	121	19
25003-2095	23	3.681	5.000	0.500	93	127	13	29502-6325	IG	3.740	4.490	0.750	95	114	19
29502-5751	IG	3.685	4.685	0.750	94	119	19	29519-7483	IG	3.740	4.528	0.625	95	115	16
29502-5258	IG	3.687	4.560	0.750	94	116	19	24060-1859	61	3.740	4.724	0.394	95	120	10
25003-2447	23	3.687	4.999	0.500	94	127	13	24125-1859	61	3.740	4.724	0.394	95	120	10
29607-6703	GD	3.688	4.125	0.625	94	105	16	25003-9190	23	3.740	4.724	0.472	95	120	12
25003-8639	23	3.688	4.688	0.375	94	119	10	25006-9190	23	3.740	4.724	0.472	95	120	12
25006-8639	23	3.688	4.688	0.375	94	119	10	24602-6061	26	3.740	4.724	0.512	95	120	13
25009-8639	23	3.688	4.688	0.375	94	119	10	26058-6061	57	3.740	4.724	0.512	95	120	13
25003-9104	23	3.688	4.688	0.500	94	119	13	24801-3021	EQUAL	3.740	4.724	0.625	95	120	16
24610-0655	26	3.688	4.688	0.500	94	119	13	24802-3021	EQUAL	3.740	4.724	0.625	95	120	16
24802-2744	EQUAL	3.688	4.688	0.625	94	119	16	29502-4978	IG	3.740	4.724	0.750	95	120	19
29602-4290	GD	3.688	4.688	0.700	94	119	18	25010-1110	23	3.740	4.740	0.375	95	120	10
29502-4290	IG	3.688	4.688	0.750	94	119	19	25003-1110	23	3.740	4.740	0.375	95	120	10
25003-5749	23	3.688	4.750	0.375	94	121	10	25003-6896	23	3.740	4.740	0.500	95	120	13
24626-3037	26	3.688	4.750	0.438	94	121	11	29602-4506	GD	3.740	4.740	0.700	95	120	18
24600-3037	26	3.688	4.750	0.438	94	121	11	29500-4506	IG	3.740	4.740	0.750	95	120	19
25003-2441	23	3.688	4.750	0.500	94	121	13	24802-1816	EQUAL	3.740	4.750	0.625	95	121	16
25006-2441	23	3.688	4.750	0.500	94	121	13	29602-6665	GD	3.740	4.764	0.700	95	121	18
25004-2441	23	3.688	4.750	0.500	94	121	13	25010-1010	23	3.740	4.921	0.472	95	125	12
24600-2441	26	3.688	4.750	0.500	94	121	13	25003-1010	23	3.740	4.921	0.472	95	125	12
24610-2441	26	3.688	4.750	0.500	94	121	13	25056-1010	25	3.740	4.921	0.472	95	125	12
24602-2441	26	3.688	4.750	0.500	94	121	13	24612-2671	26	3.740	4.921	0.472	95	125	12
21086-2441	53	3.688	4.750	0.500	94	121	13	29500-4979	IG	3.740	4.921	0.750	95	125	19
21699-2441	53	3.688	4.750	0.500	94	121	13	25010-7464	23	3.740	4.990	0.500	95	127	13
29519-2445	IG	3.688	4.750	0.625	94	121	16	25003-7464	23	3.740	4.990	0.500	95	127	13
29500-4562	IG	3.688	4.750	0.750	94	121	19	25003-3058	23	3.740	5.118	0.500	95	130	13

All dimensions are in inches. Preferred sizes are indicated with **bold** type face. Sizes listed are for standard nitrile elements, except Models 25 and 62 which have PTFE elements. Other material available on inquiry only.

## Oil Seals by Model Number

Product Code	Model	Inches			MM			Product Code	Model	Inches			MM		
		ID	OD	Width	ID	OD	Width			ID	OD	Width	ID	OD	Width
24802-2972	EQUAL	3.740	5.118	0.625	95	130	16	24821-2462	EQUAL	3.750	4.750	0.500	95	121	13
29502-6613	IG	3.740	5.315	0.750	95	135	19	21086-2463	53	3.750	4.750	0.563	95	121	14
29500-4751	IG	3.740	5.512	0.750	95	140	19	21012-2464	113	3.750	4.750	0.625	95	121	16
24831-0167	EQUAL	3.740	5.515	0.625	95	140	16	22501-2464	53G1	3.750	4.750	0.625	95	121	16
29516-7462	IG	3.740	5.807	0.804	95	147	20	22502-2464	53G1	3.750	4.750	0.625	95	121	16
24610-2283	26	3.740	4.528	0.500	95	115	13	21086-2464	53	3.750	4.750	0.625	95	121	16
24629-9190	26R1	3.740	4.724	0.472	95	120	12	29519-2464	IG	3.750	4.750	0.625	95	121	16
24620-9190	26R1	3.740	4.724	0.472	95	120	12	29607-2464	GD	3.750	4.750	0.625	95	121	16
24612-9190	26	3.740	4.724	0.472	95	120	12	24802-2464	EQUAL	3.750	4.750	0.625	95	121	16
24620-6061	26R1	3.740	4.724	0.512	95	120	13	24822-2464	EQUAL	3.750	4.750	0.625	95	121	16
29502-2952	IG	3.741	4.922	0.750	95	125	19	24824-2464	EQUAL	3.750	4.750	0.625	95	121	16
29518-6341	IG	3.741	4.991	0.875	95	127	22	24807-3781	EQUAL	3.750	4.750	0.690	95	121	18
25003-6250	23	3.741	5.240	0.500	95	133	13	29602-4158	GD	3.750	4.750	0.700	95	121	18
29602-6967	GD	3.744	4.744	0.700	95	120	18	29500-4158	IG	3.750	4.750	0.750	95	121	19
26001-7097	71	3.750	4.375	0.313	95	111	8	29502-4158	IG	3.750	4.750	0.750	95	121	19
24807-4523	EQUAL	3.750	4.375	0.690	95	111	18	22627-7440	53R2	3.750	4.750	0.906	95	121	23
24063-2235	61	3.750	4.500	0.375	95	114	10	25003-4220	23	3.750	4.765	0.500	95	121	13
29619-2210	GD	3.750	4.500	0.625	95	114	16	25003-6960	23	3.750	4.813	0.500	95	122	13
24802-2210	EQUAL	3.750	4.500	0.625	95	114	16	25003-6619	23	3.750	4.875	0.375	95	124	10
29502-6456	IG	3.750	4.500	0.750	95	114	19	25010-2465	23	3.750	4.875	0.500	95	124	13
25003-9174	23	3.750	4.625	0.375	95	117	10	25003-2465	23	3.750	4.875	0.500	95	124	13
25003-3452	23	3.750	4.625	0.500	95	117	13	21086-2465	53	3.750	4.875	0.500	95	124	13
24802-1312	EQUAL	3.750	4.625	0.625	95	117	16	21096-2465	53	3.750	4.875	0.500	95	124	13
25003-1713	23	3.750	4.732	0.405	95	120	10	21409-2465	53	3.750	4.875	0.500	95	124	13
25009-7389	23	3.750	4.750	0.375	95	121	10	21699-2465	53	3.750	4.875	0.500	95	124	13
25003-7389	23	3.750	4.750	0.375	95	121	10	24060-2465	61	3.750	4.875	0.500	95	124	13
25006-7389	23	3.750	4.750	0.375	95	121	10	29500-6119	IG	3.750	4.875	0.750	95	124	19
29609-2687	GD	3.750	4.750	0.375	95	121	10	29502-6119	IG	3.750	4.875	0.750	95	124	19
25003-4455	23	3.750	4.750	0.438	95	121	11	21702-8168	62	3.750	4.885	0.500	95	124	13
24602-3372	26	3.750	4.750	0.438	95	121	11	25003-2468	23	3.750	4.999	0.500	95	127	13
25135-2462	23	3.750	4.750	0.500	95	121	13	24620-4654	26R1	3.750	4.999	0.500	95	127	13
25045-2462	23	3.750	4.750	0.500	95	121	13	21699-2468	53	3.750	4.999	0.500	95	127	13
25138-2462	23	3.750	4.750	0.500	95	121	13	21086-2468	53	3.750	4.999	0.500	95	127	13
25003-2462	23	3.750	4.750	0.500	95	121	13	21096-2468	53	3.750	4.999	0.500	95	127	13
25144-2462	23	3.750	4.750	0.500	95	121	13	21527-2468	66	3.750	4.999	0.500	95	127	13
25006-2462	23	3.750	4.750	0.500	95	121	13	21086-2469	53	3.750	4.999	0.562	95	127	14
25004-2462	23	3.750	4.750	0.500	95	121	13	22501-2470	53G1	3.750	4.999	0.625	95	127	16
25058-2462	25	3.750	4.750	0.500	95	121	13	21086-2470	53	3.750	4.999	0.625	95	127	16
24626-2462	26	3.750	4.750	0.500	95	121	13	22897-6806	53T2	3.750	4.999	0.906	95	127	23
24600-2462	26	3.750	4.750	0.500	95	121	13	25003-9089	23	3.750	5.000	0.375	95	127	10
24610-2462	26	3.750	4.750	0.500	95	121	13	29609-6818	GD	3.750	5.000	0.375	95	127	10
24627-2462	26	3.750	4.750	0.500	95	121	13	24600-2477	26	3.750	5.000	0.438	95	127	11
24612-2462	26	3.750	4.750	0.500	95	121	13	25003-5079	23	3.750	5.000	0.500	95	127	13
21699-2462	53	3.750	4.750	0.500	95	121	13	25009-5079	23	3.750	5.000	0.500	95	127	13
21087-2462	53	3.750	4.750	0.500	95	121	13	25004-5079	23	3.750	5.000	0.500	95	127	13
21597-2462	53	3.750	4.750	0.500	95	121	13	24650-2478	26NS	3.750	5.000	0.500	95	127	13
21557-2462	53	3.750	4.750	0.500	95	121	13	24600-2478	26	3.750	5.000	0.500	95	127	13
21086-2462	53	3.750	4.750	0.500	95	121	13	24060-5079	61	3.750	5.000	0.500	95	127	13
21096-2462	53	3.750	4.750	0.500	95	121	13	29519-2483	IG	3.750	5.000	0.625	95	127	16
21095-2462	53	3.750	4.750	0.500	95	121	13	24802-2483	EQUAL	3.750	5.000	0.625	95	127	16
21947-2462	53	3.750	4.750	0.500	95	121	13	24820-2483	EQUAL	3.750	5.000	0.625	95	127	16
21003-2462	58	3.750	4.750	0.500	95	121	13	29602-5364	GD	3.750	5.000	0.700	95	127	18
24060-2462	61	3.750	4.750	0.500	95	121	13	29502-5364	IG	3.750	5.000	0.750	95	127	19
21702-2462	62	3.750	4.750	0.500	95	121	13	29521-6403	IG	3.750	5.000	0.875	95	127	22
21527-2462	66	3.750	4.750	0.500	95	121	13	22627-6806	53R2	3.750	5.000	0.906	95	127	23
24801-2462	EQUAL	3.750	4.750	0.500	95	121	13	23708-6806	53R2	3.750	5.000	0.906	95	127	23

All dimensions are in inches. Preferred sizes are indicated with **bold** type face. Sizes listed are for standard nitrile elements, except Models 25 and 62 which have PTFE elements. Other material available on inquiry only.

## Oil Seals by Model Number

Product Code	Model	Inches			MM			Product Code	Model	Inches			MM		
		ID	OD	Width	ID	OD	Width			ID	OD	Width	ID	OD	Width
25003-2471	23	3.750	5.125	0.500	95	130	13	29519-6939	IG	3.813	5.513	0.625	97	140	16
21087-2471	53	3.750	5.125	0.500	95	130	13	29619-6939	GD	3.813	5.513	0.625	97	140	16
21086-2471	53	3.750	5.125	0.500	95	130	13	25284-3096	23	3.819	5.042	0.375	97	128	10
21527-2471	66	3.750	5.125	0.500	95	130	13	25287-3096	23	3.820	5.042	0.375	97	128	10
29502-6020	IG	3.750	5.125	0.750	95	130	19	25003-3096	23	3.820	5.042	0.375	97	128	10
25003-3256	23	3.750	5.250	0.438	95	133	11	25006-3096	23	3.820	5.042	0.375	97	128	10
25087-2474	23	3.750	5.250	0.500	95	133	13	25009-3096	23	3.820	5.042	0.375	97	128	10
25003-2474	23	3.750	5.250	0.500	95	133	13	25087-2702	23	3.820	5.042	0.395	97	128	10
24610-0927	26	3.750	5.250	0.500	95	133	13	25284-2702	23	3.820	5.042	0.395	97	128	10
21086-2474	53	3.750	5.250	0.500	95	133	13	29502-4602	IG	3.825	4.875	0.750	97	124	19
21095-2474	53	3.750	5.250	0.500	95	133	13	24612-3475	26	3.825	5.075	0.500	97	129	13
21947-2474	53	3.750	5.250	0.500	95	133	13	29602-7442	GD	3.830	4.920	0.700	97	125	18
21086-2476	53	3.750	5.250	0.625	95	133	16	25003-0422	23	3.847	5.063	0.375	98	129	10
29519-1095	IG	3.750	5.250	0.625	95	133	16	29602-6681	GD	3.850	4.850	0.700	98	123	18
24802-1095	EQUAL	3.750	5.250	0.625	95	133	16	29502-4622	IG	3.850	4.875	0.750	98	124	19
24060-7249	61	3.750	5.375	0.500	95	137	13	29502-6762	IG	3.858	4.724	0.750	98	120	19
21527-7249	66	3.750	5.375	0.500	95	137	13	29619-7253	GD	3.858	4.921	0.625	98	125	16
21086-2480	53	3.750	5.500	0.500	95	140	13	29519-7253	IG	3.858	4.921	0.640	98	125	16
21699-2480	53	3.750	5.500	0.500	95	140	13	29507-6115	IG	3.875	4.250	0.625	98	108	16
29502-5757	IG	3.750	5.500	0.750	95	140	19	24807-3752	EQUAL	3.875	4.313	0.690	98	110	18
29520-6340	IG	3.750	5.750	0.750	95	146	19	29507-6417	IG	3.875	4.500	0.625	98	114	16
29619-7243	GD	3.750	5.754	0.625	95	146	16	29502-6223	IG	3.875	4.625	0.750	98	117	19
21140-6009	54	3.750	8.000	0.625	95	203	16	25003-7746	23	3.875	4.750	0.375	98	121	10
29602-6430	GD	3.776	4.777	0.700	96	121	18	24600-5637	26	3.875	4.750	0.375	98	121	10
29502-6430	IG	3.776	4.777	0.750	96	121	19	25003-5959	23	3.875	4.844	0.484	98	123	12
24802-4696	EQUAL	3.777	4.732	0.625	96	120	16	25003-3894	23	3.875	4.875	0.375	98	124	10
29602-6794	GD	3.780	4.780	0.700	96	121	18	25003-8592	23	3.875	4.875	0.438	98	124	11
24802-3039	EQUAL	3.786	4.786	0.625	96	122	16	24600-8592	26	3.875	4.875	0.438	98	124	11
29502-5721	IG	3.790	4.790	0.750	96	122	19	24610-8592	26	3.875	4.875	0.438	98	124	11
29602-6509	GD	3.800	4.800	0.700	97	122	18	25003-2501	23	3.875	4.875	0.500	98	124	13
25003-3825	23	3.800	5.062	0.375	97	129	10	25006-2501	23	3.875	4.875	0.500	98	124	13
25009-3840	23	3.812	4.812	0.375	97	122	10	25004-2501	23	3.875	4.875	0.500	98	124	13
29519-2745	IG	3.812	4.812	0.625	97	122	16	21086-2501	53	3.875	4.875	0.500	98	124	13
29602-4291	GD	3.812	4.812	0.700	97	122	18	21699-2501	53	3.875	4.875	0.500	98	124	13
29502-4291	IG	3.812	4.812	0.750	97	122	19	21702-2501	62	3.875	4.875	0.500	98	124	13
29502-5476	IG	3.812	4.875	0.750	97	124	19	24802-2503	EQUAL	3.875	4.875	0.625	98	124	16
29516-7155	IG	3.812	4.965	1.067	97	126	27	29602-4159	GD	3.875	4.875	0.700	98	124	18
21086-2489	53	3.812	5.125	0.500	97	130	13	22987-5201	53F1	3.875	4.875	0.719	98	124	18
29502-6331	IG	3.812	5.125	0.750	97	130	19	29502-4159	IG	3.875	4.875	0.750	98	124	19
24600-2498	26	3.812	5.500	0.500	97	140	13	22627-5645	53R2	3.875	4.875	0.906	98	124	23
29516-7087	IG	3.813	4.772	0.971	97	121	25	25003-4814	23	3.875	4.885	0.500	98	124	13
24816-7044	EQUAL	3.813	4.773	1.375	97	121	35	21091-2504	53	3.875	4.999	0.500	98	127	13
25003-6464	23	3.813	4.813	0.500	97	122	13	21702-2504	62	3.875	4.999	0.500	98	127	13
25006-6464	23	3.813	4.813	0.500	97	122	13	21086-2506	53	3.875	4.999	0.625	98	127	16
24602-0656	26	3.813	4.813	0.500	97	122	13	25087-9298	23	3.875	5.000	0.375	98	127	10
25003-2483	23	3.813	4.875	0.500	97	124	13	25003-9298	23	3.875	5.000	0.375	98	127	10
21086-2483	53	3.813	4.875	0.500	97	124	13	25004-9298	23	3.875	5.000	0.375	98	127	10
21003-3346	58	3.813	4.999	0.625	97	127	16	25009-9298	23	3.875	5.000	0.375	98	127	10
25003-2486	23	3.813	5.000	0.500	97	127	13	25284-9298	23	3.875	5.000	0.375	98	127	10
21086-2486	53	3.813	5.000	0.500	97	127	13	24600-2514	26	3.875	5.000	0.469	98	127	12
21095-2486	53	3.813	5.000	0.500	97	127	13	25284-4772	23	3.875	5.000	0.500	98	127	13
21699-2486	53	3.813	5.000	0.500	97	127	13	25003-4772	23	3.875	5.000	0.500	98	127	13
29502-6337	IG	3.813	5.000	0.750	97	127	19	24610-0928	26	3.875	5.000	0.500	98	127	13
21086-2492	53	3.813	5.250	0.500	97	133	13	21086-2504	53	3.875	5.000	0.500	98	127	13
21086-2495	53	3.813	5.375	0.500	97	137	13	24801-2506	EQUAL	3.875	5.000	0.625	98	127	16
21086-2498	53	3.813	5.500	0.500	97	140	13	24802-2506	EQUAL	3.875	5.000	0.625	98	127	16

All dimensions are in inches. Preferred sizes are indicated with **bold** type face.

Sizes listed are for standard nitrile elements, except Models 25 and 62 which have PTFE elements. Other material available on inquiry only.

## Oil Seals by Model Number

Product Code	Model	Inches			MM			Product Code	Model	Inches			MM		
		ID	OD	Width	ID	OD	Width			ID	OD	Width	ID	OD	Width
29502-6023	IG	3.875	5.000	0.750	98	127	19	29602-6986	GD	3.937	4.940	0.700	100	125	18
25003-4426	23	3.875	5.062	0.375	98	129	10	29502-5072	IG	3.937	4.960	0.750	100	126	19
25003-2507	23	3.875	5.125	0.500	98	130	13	29502-5397	IG	3.937	4.990	0.750	100	127	19
21086-2507	53	3.875	5.125	0.500	98	130	13	29519-2962	IG	3.937	4.999	0.625	100	127	16
21095-2507	53	3.875	5.125	0.500	98	130	13	29502-4641	IG	3.937	4.999	0.750	100	127	19
21699-2507	53	3.875	5.125	0.500	98	130	13	24610-5913	26	3.937	5.000	0.500	100	127	13
24610-3208	26	3.875	5.125	0.563	98	130	14	24626-9646	26	3.937	5.062	0.375	100	129	10
29502-6915	IG	3.875	5.187	0.750	98	132	19	24600-9646	26	3.937	5.062	0.375	100	129	10
25003-2510	23	3.875	5.250	0.500	98	133	13	25003-1979	23	3.937	5.118	0.472	100	130	12
21597-2510	53	3.875	5.250	0.500	98	133	13	21096-4643	53	3.937	5.118	0.591	100	130	15
21086-2510	53	3.875	5.250	0.500	98	133	13	29519-1346	IG	3.937	5.118	0.625	100	130	16
21699-2510	53	3.875	5.250	0.500	98	133	13	29502-4859	IG	3.937	5.118	0.750	100	130	19
21086-2511	53	3.875	5.250	0.563	98	133	14	24060-7979	61	3.937	5.119	0.512	100	130	13
29519-6327	IG	3.875	5.250	0.625	98	133	16	24610-6319	26	3.937	5.197	0.469	100	132	12
25003-2513	23	3.875	5.375	0.500	98	137	13	25003-3379	23	3.937	5.197	0.492	100	132	12
24600-2513	26	3.875	5.375	0.500	98	137	13	24600-2525	26	3.937	5.250	0.500	100	133	13
21086-2513	53	3.875	5.375	0.500	98	137	13	24610-2525	26	3.937	5.250	0.500	100	133	13
21699-2513	53	3.875	5.375	0.500	98	137	13	24802-5604	EQUAL	3.937	5.512	0.625	100	140	16
24602-2516	26	3.875	5.500	0.500	98	140	13	24610-6669	26	3.937	4.724	0.354	100	120	9
21086-2516	53	3.875	5.500	0.500	98	140	13	24627-6669	26	3.937	4.724	0.354	100	120	9
21087-2516	53	3.875	5.500	0.500	98	140	13	24062-2242	61	3.937	4.724	0.472	100	120	12
21086-2516	53	3.875	5.500	0.500	98	140	13	24626-1907	26	3.937	4.921	0.256	100	125	7
21095-2516	53	3.875	5.500	0.500	98	140	13	24600-1907	26	3.937	4.921	0.256	100	125	7
21699-2516	53	3.875	5.500	0.500	98	140	13	24060-0811	61	3.937	4.921	0.394	100	125	10
24802-1961	EQUAL	3.875	5.500	0.625	98	140	16	24620-5345	26R1	3.937	4.921	0.512	100	125	13
29602-6735	GD	3.895	4.900	0.700	99	124	18	24629-5345	26R1	3.937	4.921	0.512	100	125	13
25003-2259	23	3.897	4.876	0.500	99	124	13	24600-5345	26	3.937	4.921	0.512	100	125	13
24802-3104	EQUAL	3.900	4.900	0.625	99	124	16	21003-1979	58	3.937	5.118	0.630	100	130	16
29620-7474	GD	3.900	5.000	0.700	99	127	18	24600-5924	26	3.937	6.693	0.394	100	170	10
25003-0503	23	3.907	5.118	0.500	99	130	13	24807-3271	EQUAL	3.938	4.563	0.690	100	116	18
29602-6956	GD	3.915	4.915	0.700	99	125	18	24807-3557	EQUAL	3.938	4.688	0.690	100	119	18
25003-2294	23	3.916	5.234	0.500	99	133	13	29602-6418	GD	3.938	4.688	0.700	100	119	18
24626-6542	26	3.917	4.724	0.472	99	120	12	29516-7158	IG	3.938	4.708	0.862	100	120	22
29502-6171	IG	3.920	4.920	0.750	100	125	19	24637-2560	26	3.938	4.724	0.394	100	120	10
25003-9487	23	3.922	4.922	0.500	100	125	13	24608-6232	26R1	3.938	4.724	0.472	100	120	12
29602-5648	GD	3.925	4.925	0.700	100	125	18	25003-9284	23	3.938	4.724	0.500	100	120	13
29502-5648	IG	3.925	4.925	0.750	100	125	19	24629-9030	26R1	3.938	4.724	0.511	100	120	13
29502-6330	IG	3.931	5.125	0.750	100	130	19	24620-9030	26R1	3.938	4.724	0.511	100	120	13
25003-4747	23	3.933	4.933	0.500	100	125	13	24802-1347	EQUAL	3.938	4.724	0.625	100	120	16
24802-3983	EQUAL	3.934	4.934	0.625	100	125	16	29500-4980	IG	3.938	4.724	0.750	100	120	19
24802-4697	EQUAL	3.934	5.120	0.625	100	130	16	29502-4980	IG	3.938	4.724	0.750	100	120	19
29602-7481	GD	3.935	4.928	0.700	100	125	18	24600-4634	26	3.938	4.734	0.511	100	120	13
29602-6821	GD	3.935	4.935	0.700	100	125	18	25003-7036	23	3.938	4.813	0.375	100	122	10
25003-3348	23	3.935	4.960	0.500	100	126	13	24102-3422	61	3.938	4.875	0.040	100	124	1
29607-6729	GD	3.937	4.615	0.625	100	117	16	25003-4616	23	3.938	4.875	0.437	100	124	11
29607-6639	GD	3.937	4.627	0.625	100	118	16	25003-5872	23	3.938	4.875	0.500	100	124	13
24802-6768	EQUAL	3.937	4.687	0.625	100	119	16	24060-5872	61	3.938	4.875	0.500	100	124	13
21003-4263	58	3.937	4.724	0.433	100	120	11	24801-2533	EQUAL	3.938	4.875	0.500	100	124	13
24077-2242	61	3.937	4.724	0.472	100	120	12	24801-3830	EQUAL	3.938	4.875	0.625	100	124	16
24063-2242	61	3.937	4.724	0.472	100	120	12	24620-2494	26R1	3.938	4.881	0.625	100	124	16
24612-9284	26	3.937	4.724	0.500	100	120	13	24802-2942	EQUAL	3.938	4.883	0.625	100	124	16
29524-4980	IG	3.937	4.724	0.750	100	120	19	24802-2891	EQUAL	3.938	4.900	0.625	100	124	16
24622-4437	26R1	3.937	4.725	0.433	100	120	11	25003-1746	23	3.938	4.906	0.484	100	125	12
24610-9284	26	3.937	4.725	0.500	100	120	13	25003-1766	23	3.938	4.906	0.484	100	125	12
29500-4649	IG	3.937	4.921	0.750	100	125	19	25010-8483	23	3.938	4.906	0.484	100	125	12
24608-5591	26	3.937	4.937	0.437	100	125	11	25003-8483	23	3.938	4.906	0.484	100	125	12

All dimensions are in inches. Preferred sizes are indicated with **bold** type face.

Sizes listed are for standard nitrile elements, except Models 25 and 62 which have PTFE elements. Other material available on inquiry only.

## Oil Seals by Model Number

Product Code	Model	Inches			MM			Product Code	Model	Inches			MM		
		ID	OD	Width	ID	OD	Width			ID	OD	Width	ID	OD	Width
25006-8483	23	3.938	4.906	0.484	100	125	12	24602-5913	26	3.938	5.000	0.500	100	127	13
25003-8790	23	3.938	4.906	0.500	100	125	13	21096-2519	53	3.938	5.000	0.500	100	127	13
25284-8790	23	3.938	4.906	0.500	100	125	13	21095-2519	53	3.938	5.000	0.500	100	127	13
25003-5363	23	3.938	4.921	0.433	100	125	11	21699-2519	53	3.938	5.000	0.500	100	127	13
24638-2559	26	3.938	4.921	.472	100	125	12	24062-5913	61	3.938	5.000	0.500	100	127	13
25003-1875	23	3.938	4.921	0.492	100	125	12	21702-2519	62	3.938	5.000	0.500	100	127	13
25004-1875	23	3.938	4.921	0.492	100	125	12	24627-3155	26	3.938	5.000	0.625	100	127	16
25003-3248	23	3.938	4.921	0.500	100	125	13	22502-2521	53G1	3.938	5.000	0.625	100	127	16
24801-2230	EQUAL	3.938	4.921	0.625	100	125	16	21086-2521	53	3.938	5.000	0.625	100	127	16
24802-2230	EQUAL	3.938	4.921	0.625	100	125	16	24801-2962	EQUAL	3.938	5.000	0.625	100	127	16
29502-4649	IG	3.938	4.921	0.750	100	125	19	24819-2962	EQUAL	3.938	5.000	0.625	100	127	16
21699-4817	53	3.938	4.937	0.500	100	125	13	24829-3155	EQUAL	3.938	5.000	0.625	100	127	16
25003-6709	23	3.938	4.938	0.375	100	125	10	29502-5966	IG	3.938	5.000	0.750	100	127	19
25048-6709	25	3.938	4.938	0.375	100	125	10	22537-5049	53R1	3.938	5.000	0.906	100	127	23
24620-6709	26R1	3.938	4.938	0.375	100	125	10	22543-5049	53R1	3.938	5.000	0.906	100	127	23
25003-2523	23	3.938	4.938	0.438	100	125	11	25003-1000	23	3.938	5.040	0.400	100	128	10
25010-4817	23	3.938	4.938	0.500	100	125	13	25087-9646	23	3.938	5.062	0.375	100	129	10
25138-4817	23	3.938	4.938	0.500	100	125	13	25006-9646	23	3.938	5.062	0.375	100	129	10
25003-4817	23	3.938	4.938	0.500	100	125	13	25004-9646	23	3.938	5.062	0.375	100	129	10
25006-4817	23	3.938	4.938	0.500	100	125	13	25009-9646	23	3.938	5.062	0.375	100	129	10
24600-4817	26	3.938	4.938	0.500	100	125	13	25284-9646	23	3.938	5.062	0.375	100	129	10
24610-4817	26	3.938	4.938	0.500	100	125	13	25003-6111	23	3.938	5.062	0.500	100	129	13
21086-4817	53	3.938	4.938	0.500	100	125	13	25287-9646	23	3.938	5.063	0.375	100	129	10
21095-4817	53	3.938	4.938	0.500	100	125	13	29516-7133	IG	3.938	5.085	1.050	100	129	27
29505-4817	IG	3.938	4.938	0.500	100	125	13	25003-3229	23	3.938	5.118	0.375	100	130	10
29507-1144	IG	3.938	4.938	0.625	100	125	16	21096-7842	53	3.938	5.118	0.472	100	130	12
29519-1144	IG	3.938	4.938	0.625	100	125	16	21086-7842	53	3.938	5.118	0.472	100	130	12
24801-1144	EQUAL	3.938	4.938	0.625	100	125	16	25003-7979	23	3.938	5.118	0.500	100	130	13
24802-1144	EQUAL	3.938	4.938	0.625	100	125	16	21096-7979	53	3.938	5.118	0.500	100	130	13
24805-1144	EQUAL	3.938	4.938	0.625	100	125	16	21086-7979	53	3.938	5.118	0.500	100	130	13
29602-4292	GD	3.938	4.938	0.700	100	125	18	21699-7979	53	3.938	5.118	0.500	100	130	13
29500-4292	IG	3.938	4.938	0.750	100	125	19	24801-1346	EQUAL	3.938	5.118	0.625	100	130	16
29502-4292	IG	3.938	4.938	0.750	100	125	19	24802-1346	EQUAL	3.938	5.118	0.625	100	130	16
25003-2622	23	3.938	4.950	0.500	100	126	13	25003-2548	23	3.938	5.125	0.468	100	130	12
24816-7048	EQUAL	3.938	4.955	1.252	100	126	32	25003-2522	23	3.938	5.125	0.500	100	130	13
24816-7026	EQUAL	3.938	4.957	1.375	100	126	35	21086-2522	53	3.938	5.125	0.500	100	130	13
29516-7098	IG	3.938	4.960	0.994	100	126	25	26058-2522	57	3.938	5.125	0.500	100	130	13
29616-7098	GD	3.938	4.960	1.297	100	126	33	26063-2522	57	3.938	5.125	0.500	100	130	13
24816-7018	EQUAL	3.938	4.984	1.375	100	127	35	26057-2522	57	3.938	5.125	0.500	100	130	13
29502-6035	IG	3.938	4.985	0.750	100	127	19	26060-2522	57	3.938	5.125	0.500	100	130	13
21087-2519	53	3.938	4.999	0.500	100	127	13	25003-4776	23	3.938	5.188	0.500	100	132	13
21086-2519	53	3.938	4.999	0.500	100	127	13	24622-2526	26R1	3.938	5.188	0.512	100	132	13
21947-2519	53	3.938	4.999	0.500	100	127	13	24610-3653	26	3.938	5.188	0.563	100	132	14
29500-4641	IG	3.938	4.999	0.750	100	127	19	29500-4845	IG	3.938	5.188	0.750	100	132	19
25003-1448	23	3.938	5.000	0.400	100	127	10	24824-2945	EQUAL	3.938	5.200	0.500	100	132	13
25009-1448	23	3.938	5.000	0.400	100	127	10	25003-2525	23	3.938	5.250	0.500	100	133	13
25003-2493	23	3.938	5.000	0.438	100	127	11	24627-2525	26	3.938	5.250	0.500	100	133	13
25003-6129	23	3.938	5.000	0.469	100	127	12	21087-2525	53	3.938	5.250	0.500	100	133	13
24610-6129	26	3.938	5.000	0.469	100	127	12	21086-2525	53	3.938	5.250	0.500	100	133	13
24612-6129	26	3.938	5.000	0.469	100	127	12	21086-2527	53	3.938	5.250	0.625	100	133	16
25003-2519	23	3.938	5.000	0.500	100	127	13	29519-3474	IG	3.938	5.250	0.625	100	133	16
25004-2519	23	3.938	5.000	0.500	100	127	13	24801-3474	EQUAL	3.938	5.250	0.625	100	133	16
25003-5913	23	3.938	5.000	0.500	100	127	13	29602-5128	GD	3.938	5.250	0.700	100	133	18
25006-5913	23	3.938	5.000	0.500	100	127	13	29502-5128	IG	3.938	5.250	0.750	100	133	19
25058-5913	25	3.938	5.000	0.500	100	127	13	24802-3474	EQUAL	3.938	5.251	0.625	100	133	16
24600-5913	26	3.938	5.000	0.500	100	127	13	25003-1145	23	3.938	5.256	0.469	100	134	12

All dimensions are in inches. Preferred sizes are indicated with **bold** type face.

Sizes listed are for standard nitrile elements, except Models 25 and 62 which have PTFE elements. Other material available on inquiry only.

## Oil Seals by Model Number

Product Code	Model	Inches			MM			Product Code	Model	Inches			MM		
		ID	OD	Width	ID	OD	Width			ID	OD	Width	ID	OD	Width
25003-6205	23	3.938	5.313	0.500	100	135	13	21086-2537	53	4.000	4.999	0.500	102	127	13
24802-4091	EQUAL	3.938	5.315	0.625	100	135	16	21091-2537	53	4.000	4.999	0.500	102	127	13
24816-7031	EQUAL	3.938	5.328	1.375	100	135	35	21699-2537	53	4.000	4.999	0.500	102	127	13
21086-2528	53	3.938	5.375	0.500	100	137	13	21095-2537	53	4.000	4.999	0.500	102	127	13
25003-2528	23	3.938	5.376	0.500	100	137	13	21947-2537	53	4.000	4.999	0.500	102	127	13
25003-7416	23	3.938	5.438	0.500	100	138	13	21409-2537	53	4.000	4.999	0.500	102	127	13
21086-2531	53	3.938	5.500	0.500	100	140	13	21702-2537	62	4.000	4.999	0.500	102	127	13
24802-2046	EQUAL	3.938	5.501	0.625	100	140	16	21527-2537	66	4.000	4.999	0.500	102	127	13
21086-3787	53	3.938	5.512	0.472	100	140	12	21096-2539	53	4.000	4.999	0.625	102	127	16
21086-2534	53	3.938	5.625	0.500	100	143	13	25284-6360	23	4.000	5.000	0.375	102	127	10
24816-7189	EQUAL	3.938	5.640	0.808	100	143	21	25003-6360	23	4.000	5.000	0.375	102	127	10
24816-7047	EQUAL	3.938	5.643	1.125	100	143	29	25006-6360	23	4.000	5.000	0.375	102	127	10
29516-5113	IG	3.938	5.807	0.828	100	147	21	25004-6360	23	4.000	5.000	0.375	102	127	10
29518-6786	IG	3.938	5.900	0.820	100	150	21	25058-6360	25	4.000	5.000	0.375	102	127	10
27223-6323	94	3.938	5.906	0.500	100	150	13	24626-0978	26	4.000	5.000	0.375	102	127	10
24829-3429	EQUAL	3.938	5.938	0.625	100	151	16	24600-0978	26	4.000	5.000	0.375	102	127	10
29516-7117	IG	3.938	6.201	0.988	100	158	25	24610-0978	26	4.000	5.000	0.375	102	127	10
29500-4640	IG	3.938	6.375	0.750	100	162	19	24076-9662	61	4.000	5.000	0.437	102	127	11
29602-6766	GD	3.940	4.940	0.700	100	125	18	25009-9662	23	4.000	5.000	0.438	102	127	11
29602-6685	GD	3.940	4.955	0.700	100	126	18	25054-9662	23	4.000	5.000	0.438	102	127	11
24802-3018	EQUAL	3.948	4.948	0.625	100	126	16	25003-9662	23	4.000	5.000	0.438	102	127	11
24610-5224	26	3.949	5.197	0.563	100	132	14	25006-9662	23	4.000	5.000	0.438	102	127	11
29502-7310	IG	3.953	4.724	0.750	100	120	19	24626-9662	26	4.000	5.000	0.438	102	127	11
24060-4087	61	3.960	4.875	0.375	101	124	10	24600-9662	26	4.000	5.000	0.438	102	127	11
29616-7117	GD	3.973	6.201	0.994	101	158	25	24610-9662	26	4.000	5.000	0.438	102	127	11
24600-4225	26	3.976	5.551	0.630	101	141	16	24602-9662	26	4.000	5.000	0.438	102	127	11
24060-3775	61	3.976	5.512	0.512	101	140	13	24600-2592	26	4.000	5.000	0.469	102	127	12
29502-5571	IG	3.981	4.987	0.750	101	127	19	25010-4651	23	4.000	5.000	0.500	102	127	13
26001-9016	71	4.000	4.500	0.250	102	114	6	25003-4651	23	4.000	5.000	0.500	102	127	13
29507-5137	IG	4.000	4.500	0.625	102	114	16	25006-4651	23	4.000	5.000	0.500	102	127	13
26193-9879	76	4.000	4.625	0.312	102	117	8	25004-4651	23	4.000	5.000	0.500	102	127	13
24627-2587	26	4.000	4.750	0.438	102	121	11	25009-4651	23	4.000	5.000	0.500	102	127	13
24610-2587	26	4.000	4.750	0.438	102	121	11	25284-4651	23	4.000	5.000	0.500	102	127	13
24060-1488	61	4.000	4.750	0.500	102	121	13	25058-4651	25	4.000	5.000	0.500	102	127	13
25003-2554	23	4.000	4.875	0.500	102	124	13	24626-4651	26	4.000	5.000	0.500	102	127	13
24620-2554	26R1	4.000	4.875	0.500	102	124	13	24683-4651	26	4.000	5.000	0.500	102	127	13
24600-2590	26	4.000	4.875	0.563	102	124	14	24600-4651	26	4.000	5.000	0.500	102	127	13
24602-2590	26	4.000	4.875	0.563	102	124	14	24610-4651	26	4.000	5.000	0.500	102	127	13
24600-2591	26	4.000	4.875	0.625	102	124	16	24062-4651	61	4.000	5.000	0.500	102	127	13
29502-5203	IG	4.000	4.875	0.750	102	124	19	24060-4651	61	4.000	5.000	0.500	102	127	13
25003-4738	23	4.000	4.897	0.500	102	124	13	24107-4651	61	4.000	5.000	0.500	102	127	13
25003-9851	23	4.000	4.938	0.375	102	125	10	24063-4651	61	4.000	5.000	0.500	102	127	13
25004-9851	23	4.000	4.938	0.375	102	125	10	21767-4651	62	4.000	5.000	0.500	102	127	13
25009-9851	23	4.000	4.938	0.375	102	125	10	21702-4651	62	4.000	5.000	0.500	102	127	13
25003-2557	23	4.000	4.938	0.500	102	125	13	24801-4651	EQUAL	4.000	5.000	0.500	102	127	13
29516-7175	IG	4.000	4.960	0.994	102	126	25	24600-2593	26	4.000	5.000	0.625	102	127	16
25003-3801	23	4.000	4.990	0.400	102	127	10	22501-2539	53G1	4.000	5.000	0.625	102	127	16
29502-5983	IG	4.000	4.990	0.750	102	127	19	21086-2539	53	4.000	5.000	0.625	102	127	16
25006-2537	23	4.000	4.999	0.500	102	127	13	24801-2593	EQUAL	4.000	5.000	0.625	102	127	16
25054-2537	23	4.000	4.999	0.500	102	127	13	24802-2593	EQUAL	4.000	5.000	0.625	102	127	16
25003-2537	23	4.000	4.999	0.500	102	127	13	24803-2593	EQUAL	4.000	5.000	0.625	102	127	16
25004-2537	23	4.000	4.999	0.500	102	127	13	29602-4160	GD	4.000	5.000	0.700	102	127	18
24602-2537	26	4.000	4.999	0.500	102	127	13	22987-6990	53F1	4.000	5.000	0.719	102	127	18
21096-2537	53	4.000	4.999	0.500	102	127	13	29500-4160	IG	4.000	5.000	0.750	102	127	19
21087-2537	53	4.000	4.999	0.500	102	127	13	29502-4160	IG	4.000	5.000	0.750	102	127	19
21597-2537	53	4.000	4.999	0.500	102	127	13	29522-4160	IG	4.000	5.000	0.750	102	127	19

All dimensions are in inches. Preferred sizes are indicated with **bold** type face.

Sizes listed are for standard nitrile elements, except Models 25 and 62 which have PTFE elements. Other material available on inquiry only.

## Oil Seals by Model Number

Product Code	Model	Inches			MM			Product Code	Model	Inches			MM		
		ID	OD	Width	ID	OD	Width			ID	OD	Width	ID	OD	Width
29521-6451	IG	4.000	5.000	0.875	102	127	22	24822-2633	EQUAL	4.000	5.375	0.625	102	137	16
22627-6799	53R2	4.000	5.000	0.906	102	127	23	25003-2553	23	4.000	5.500	0.438	102	140	11
25003-4223	23	4.000	5.015	0.500	102	127	13	25003-2549	23	4.000	5.500	0.500	102	140	13
25003-9741	23	4.000	5.031	0.375	102	128	10	21086-2549	53	4.000	5.500	0.500	102	140	13
25003-9824	23	4.000	5.031	0.500	102	128	13	21699-2549	53	4.000	5.500	0.500	102	140	13
25006-9824	23	4.000	5.031	0.500	102	128	13	21699-2663	53	4.000	5.500	0.500	102	140	13
21086-7980	53	4.000	5.118	0.500	102	130	13	21527-2549	66	4.000	5.500	0.500	102	140	13
25003-8957	23	4.000	5.125	0.375	102	130	10	21086-2550	53	4.000	5.500	0.563	102	140	14
25006-8957	23	4.000	5.125	0.375	102	130	10	21086-2551	53	4.000	5.500	0.625	102	140	16
25009-8957	23	4.000	5.125	0.375	102	130	10	22987-7448	53F1	4.000	5.500	0.719	102	140	18
24664-5388	26HR	4.000	5.125	0.438	102	130	11	29500-9217	IG	4.000	5.500	0.750	102	140	19
25003-2540	23	4.000	5.125	0.500	102	130	13	25003-2985	23	4.000	5.625	0.375	102	143	10
25006-2540	23	4.000	5.125	0.500	102	130	13	25004-2985	23	4.000	5.625	0.375	102	143	10
24610-4045	26	4.000	5.125	0.500	102	130	13	21086-2552	53	4.000	5.625	0.500	102	143	13
21699-2540	53	4.000	5.125	0.500	102	130	13	24600-2555	26	4.000	5.750	0.500	102	146	13
21096-2540	53	4.000	5.125	0.500	102	130	13	21086-2555	53	4.000	5.750	0.500	102	146	13
21087-2540	53	4.000	5.125	0.500	102	130	13	21699-2555	53	4.000	5.750	0.500	102	146	13
21086-2540	53	4.000	5.125	0.500	102	130	13	21527-2555	66	4.000	5.750	0.500	102	146	13
24060-2540	61	4.000	5.125	0.500	102	130	13	21086-2556	53	4.000	5.750	0.563	102	146	14
24610-0993	26	4.000	5.125	0.563	102	130	14	21699-2556	53	4.000	5.750	0.563	102	146	14
21086-2541	53	4.000	5.125	0.563	102	130	14	29619-1894	GD	4.000	5.750	0.625	102	146	16
21011-2542	111	4.000	5.125	0.625	102	130	16	21086-2558	53	4.000	5.875	0.500	102	149	13
21086-2542	53	4.000	5.125	0.625	102	130	16	21086-2561	53	4.000	6.000	0.500	102	152	13
24802-2542	EQUAL	4.000	5.125	0.625	102	130	16	21373-2561	53	4.000	6.000	0.500	102	152	13
29502-6770	IG	4.000	5.125	0.750	102	130	19	29502-6690	IG	4.000	6.000	0.750	102	152	19
22627-7559	53R2	4.000	5.125	0.906	102	130	23	21086-2564	53	4.000	6.125	0.500	102	156	13
25087-9648	23	4.000	5.131	0.375	102	130	10	21086-2566	53	4.000	6.125	0.625	102	156	16
25003-9648	23	4.000	5.131	0.375	102	130	10	21086-2567	53	4.000	6.250	0.500	102	159	13
24801-0930	EQUAL	4.000	5.248	0.500	102	133	13	21699-2567	53	4.000	6.250	0.500	102	159	13
24600-4645	26	4.000	5.250	0.313	102	133	8	22500-2569	53G1	4.000	6.250	0.625	102	159	16
24801-1056	EQUAL	4.000	5.250	0.438	102	133	11	21140-6010	54	4.000	8.000	0.625	102	203	16
24600-2595	26	4.000	5.250	0.468	102	133	12	24807-4471	EQUAL	4.003	4.500	0.690	102	114	18
25010-2543	23	4.000	5.250	0.500	102	133	13	24610-3103	26	4.016	5.236	0.625	102	133	16
25003-2543	23	4.000	5.250	0.500	102	133	13	25003-2533	23	4.016	5.438	0.500	102	138	13
25006-2543	23	4.000	5.250	0.500	102	133	13	29502-6183	IG	4.030	4.960	0.750	102	126	19
25004-2543	23	4.000	5.250	0.500	102	133	13	29602-6941	GD	4.060	5.060	0.700	103	129	18
21597-2543	53	4.000	5.250	0.500	102	133	13	25004-1928	23	4.062	5.000	0.375	103	127	10
21086-2543	53	4.000	5.250	0.500	102	133	13	24627-0658	26	4.062	5.062	0.500	103	129	13
21409-2543	53	4.000	5.250	0.500	102	133	13	25003-6298	23	4.062	5.125	0.469	103	130	12
21527-2543	66	4.000	5.250	0.500	102	133	13	25003-2570	23	4.062	5.125	0.500	103	130	13
24627-2544	26	4.000	5.250	0.563	102	133	14	25003-2573	23	4.062	5.250	0.500	103	133	13
24610-2544	26	4.000	5.250	0.563	102	133	14	25003-0202	23	4.062	5.256	0.469	103	134	12
21086-2544	53	4.000	5.250	0.563	102	133	14	25003-6616	23	4.062	5.313	0.500	103	135	13
21011-2545	111	4.000	5.250	0.625	102	133	16	25003-2579	23	4.062	5.500	0.500	103	140	13
24610-3060	26	4.000	5.250	0.625	102	133	16	25009-7123	23	4.063	5.063	0.500	103	129	13
21086-2545	53	4.000	5.250	0.625	102	133	16	25003-7123	23	4.063	5.063	0.500	103	129	13
29500-5480	IG	4.000	5.250	0.750	102	133	19	24610-0658	26	4.063	5.063	0.500	103	129	13
29502-5480	IG	4.000	5.250	0.750	102	133	19	29602-4293	GD	4.063	5.063	0.700	103	129	18
22537-6434	53R1	4.000	5.250	0.906	102	133	23	29502-4293	IG	4.063	5.063	0.750	103	129	19
25003-6409	23	4.000	5.265	0.500	102	134	13	21086-2570	53	4.063	5.125	0.500	103	130	13
25003-2546	23	4.000	5.375	0.500	102	137	13	29502-4572	IG	4.063	5.125	0.750	103	130	19
24600-2546	26	4.000	5.375	0.500	102	137	13	24060-3386	61	4.063	5.250	0.375	103	133	10
21086-2546	53	4.000	5.375	0.500	102	137	13	21086-2573	53	4.063	5.250	0.500	103	133	13
21098-2546	53	4.000	5.375	0.500	102	137	13	21699-2573	53	4.063	5.250	0.500	103	133	13
21699-2546	53	4.000	5.375	0.500	102	137	13	21699-2573	53	4.063	5.250	0.500	103	133	13
22502-0939	53G1	4.000	5.375	0.625	102	137	16	25003-3916	23	4.063	5.375	0.375	103	137	10
								25003-3906	23	4.063	5.500	0.500	103	140	13

All dimensions are in inches. Preferred sizes are indicated with **bold** type face.

Sizes listed are for standard nitrile elements, except Models 25 and 62 which have PTFE elements. Other material available on inquiry only.





## Oil Seals by Model Number

Product Code	Model	Inches			MM			Product Code	Model	Inches			MM		
		ID	OD	Width	ID	OD	Width			ID	OD	Width	ID	OD	Width
24802-5309	EQUAL	4.133	5.511	0.625	105	140	16	29602-4295	GD	4.188	5.188	0.700	106	132	18
21947-8768	53	4.134	5.118	0.472	105	130	12	29502-4295	IG	4.188	5.188	0.750	106	132	19
24620-5400	26R1	4.134	5.118	0.591	105	130	15	29522-4295	IG	4.188	5.188	0.750	106	132	19
24602-0775	26	4.134	5.315	0.472	105	135	12	29516-7088	IG	4.188	5.230	1.062	106	133	27
24629-1034	26R1	4.134	5.315	0.551	105	135	14	29616-7088	GD	4.188	5.230	1.297	106	133	33
24620-1034	26R1	4.134	5.315	0.551	105	135	14	24816-7027	EQUAL	4.188	5.230	1.375	106	133	35
24600-5353	26	4.134	5.315	0.551	105	135	14	24816-7006	EQUAL	4.188	5.243	1.375	106	133	35
24602-3929	26	4.134	5.118	0.472	105	130	12	24600-2644	26	4.188	5.250	0.468	106	133	12
25010-2000	23	4.134	5.118	0.500	105	130	13	25003-2644	23	4.188	5.250	0.469	106	133	12
25003-2000	23	4.134	5.118	0.500	105	130	13	25003-2630	23	4.188	5.250	0.500	106	133	13
25003-6052	23	4.134	5.118	0.512	105	130	13	24610-0755	26	4.188	5.250	0.500	106	133	13
29519-2625	IG	4.134	5.118	0.625	105	130	16	21087-2630	53	4.188	5.250	0.500	106	133	13
24801-2625	EQUAL	4.134	5.118	0.625	105	130	16	21086-2630	53	4.188	5.250	0.500	106	133	13
24802-2625	EQUAL	4.134	5.118	0.625	105	130	16	21095-2630	53	4.188	5.250	0.500	106	133	13
29500-4981	IG	4.134	5.118	0.750	105	130	19	21409-2630	53	4.188	5.250	0.500	106	133	13
29502-4981	IG	4.134	5.118	0.750	105	130	19	21699-2630	53	4.188	5.250	0.500	106	133	13
29521-6663	IG	4.134	5.118	0.875	105	130	22	24600-2646	26	4.188	5.250	0.625	106	133	16
24802-2629	EQUAL	4.134	5.134	0.625	105	130	16	29602-7363	GD	4.188	5.250	0.700	106	133	18
29699-0003	GD	4.134	5.250	0.700	105	133	18	29502-4366	IG	4.188	5.250	0.750	106	133	19
25003-5763	23	4.134	5.315	0.500	105	135	13	22897-8811	53T2	4.188	5.250	0.969	106	133	25
24626-5353	26	4.134	5.315	0.551	105	135	14	24802-2623	EQUAL	4.188	5.256	0.625	106	134	16
24610-5353	26	4.134	5.315	0.551	105	135	14	24610-5091	26	4.188	5.313	0.563	106	135	14
29502-7439	IG	4.134	5.315	0.750	105	135	19	25003-7129	23	4.188	5.375	0.470	106	137	12
24612-6078	26	4.134	5.384	0.500	105	137	13	25003-2633	23	4.188	5.375	0.500	106	137	13
25003-0866	23	4.134	5.512	0.473	105	140	12	21086-2635	53	4.188	5.375	0.625	106	137	16
21096-4644	53	4.134	5.512	0.591	105	140	15	25003-6783	23	4.188	5.438	0.500	106	138	13
29502-4982	IG	4.134	5.512	0.750	105	140	19	25003-2636	23	4.188	5.500	0.500	106	140	13
29602-6674	GD	4.140	5.140	0.700	105	131	18	24602-2636	26	4.188	5.500	0.500	106	140	13
25003-4226	23	4.142	5.543	0.500	105	141	13	21086-2636	53	4.188	5.500	0.500	106	140	13
29502-2953	IG	4.145	5.145	0.750	105	131	19	21095-2636	53	4.188	5.500	0.500	106	140	13
29619-6604	GD	4.148	5.349	0.625	105	136	16	21699-2636	53	4.188	5.500	0.500	106	140	13
29602-6679	GD	4.150	5.150	0.700	105	131	18	21702-2636	62	4.188	5.500	0.500	106	140	13
24806-4229	EQUAL	4.156	6.046	0.625	106	154	16	24610-2637	26	4.188	5.500	0.563	106	140	14
29500-4497	IG	4.166	5.500	0.750	106	140	19	24802-2106	EQUAL	4.188	5.500	0.625	106	140	16
25003-4880	23	4.166	5.506	0.500	106	140	13	21086-2639	53	4.188	5.625	0.500	106	143	13
29602-7460	GD	4.175	5.175	0.700	106	131	18	25003-5190	23	4.188	5.688	0.375	106	144	10
29502-6441	IG	4.182	5.182	0.750	106	132	19	25006-5190	23	4.188	5.688	0.375	106	144	10
29602-6689	GD	4.185	5.185	0.700	106	132	18	25004-5190	23	4.188	5.688	0.375	106	144	10
25003-2938	23	4.186	5.186	0.500	106	132	13	21096-2642	53	4.188	5.750	0.500	106	146	13
24060-2074	61	4.187	4.999	0.468	106	127	12	21096-2645	53	4.188	5.875	0.500	106	149	13
24822-2646	EQUAL	4.187	5.250	0.625	106	133	16	21086-2645	53	4.188	5.875	0.500	106	149	13
25003-2355	23	4.187	5.312	0.500	106	135	13	21095-2645	53	4.188	5.875	0.500	106	149	13
25003-2635	23	4.187	5.375	0.625	106	137	16	21699-2645	53	4.188	5.875	0.500	106	149	13
21086-2637	53	4.187	5.500	0.562	106	140	14	24802-1960	EQUAL	4.188	5.875	0.625	106	149	16
21086-2642	53	4.187	5.750	0.500	106	146	13	21086-2648	53	4.188	6.000	0.500	106	152	13
29602-6746	GD	4.187	6.000	0.700	106	152	18	21699-2648	53	4.188	6.000	0.500	106	152	13
29502-6746	IG	4.187	6.000	0.750	106	152	19	29502-5996	IG	4.216	5.750	0.750	107	146	19
24063-2403	61	4.188	4.999	0.438	106	127	11	25045-5635	23	4.217	5.280	0.500	107	134	13
24802-1768	EQUAL	4.188	5.004	0.625	106	127	16	25003-5635	23	4.217	5.280	0.500	107	134	13
25009-4758	23	4.188	5.188	0.375	106	132	10	24802-3210	EQUAL	4.230	5.230	0.625	107	133	16
25003-4758	23	4.188	5.188	0.375	106	132	10	24802-3224	EQUAL	4.245	5.245	0.625	108	133	16
25003-2641	23	4.188	5.188	0.500	106	132	13	24802-3282	EQUAL	4.245	5.626	0.625	108	143	16
24610-2641	26	4.188	5.188	0.500	106	132	13	26001-7546	71	4.250	4.813	0.109	108	122	3
29619-2747	GD	4.188	5.188	0.625	106	132	16	24600-2653	26	4.250	5.000	0.438	108	127	11
24802-2747	EQUAL	4.188	5.188	0.625	106	132	16	25003-2578	23	4.250	5.062	0.375	108	129	10
24806-2747	EQUAL	4.188	5.188	0.625	106	132	16	24060-1652	61	4.250	5.125	0.500	108	130	13

All dimensions are in inches. Preferred sizes are indicated with **bold** type face.

Sizes listed are for standard nitrile elements, except Models 25 and 62 which have PTFE elements. Other material available on inquiry only.















## Oil Seals by Model Number

Product Code	Model	Inches			MM			Product Code	Model	Inches			MM		
		ID	OD	Width	ID	OD	Width			ID	OD	Width	ID	OD	Width
21086-2809	53	4.625	6.000	0.625	117	152	16	29502-5550	IG	4.724	5.512	0.750	120	140	19
22987-9347	53F1	4.625	6.000	0.719	117	152	18	29602-6931	GD	4.724	5.692	0.700	120	145	18
22897-7689	53T2	4.625	6.000	0.969	117	152	25	25003-5366	23	4.724	5.708	0.433	120	145	11
22903-7689	53T2	4.625	6.000	0.969	117	152	25	24626-0994	26	4.724	5.708	0.433	120	145	11
25003-8614	23	4.625	6.077	0.484	117	154	12	24600-0994	26	4.724	5.708	0.433	120	145	11
25003-2719	23	4.625	6.095	0.500	117	155	13	25003-2634	23	4.724	5.708	0.500	120	145	13
25003-2810	23	4.625	6.125	0.500	117	156	13	25048-0502	25	4.724	5.709	0.492	120	145	12
21086-2810	53	4.625	6.125	0.500	117	156	13	29507-7272	IG	4.724	5.709	0.625	120	145	16
24627-2815	26	4.625	6.125	0.562	117	156	14	29602-5159	GD	4.724	5.724	0.700	120	145	18
25003-2813	23	4.625	6.250	0.500	117	159	13	29500-5159	IG	4.724	5.724	0.750	120	145	19
21086-2813	53	4.625	6.250	0.500	117	159	13	29502-5159	IG	4.724	5.724	0.750	120	145	19
21699-2813	53	4.625	6.250	0.500	117	159	13	29504-5159	IG	4.724	5.724	0.750	120	145	19
29519-6940	IG	4.625	6.538	0.625	117	166	16	21096-7376	53	4.724	5.905	0.472	120	150	12
29619-6940	GD	4.625	6.538	0.625	117	166	16	25003-8242	23	4.724	5.906	0.433	120	150	11
29502-5636	IG	4.640	5.640	0.750	118	143	19	21086-7376	53	4.724	5.906	0.472	120	150	12
29507-5326	IG	4.646	5.036	0.625	118	128	16	25003-5118	23	4.724	5.906	0.500	120	150	13
25003-3850	23	4.646	5.906	0.472	118	150	12	25006-5118	23	4.724	5.906	0.500	120	150	13
24802-5510	EQUAL	4.646	5.906	0.625	118	150	16	24602-5118	26	4.724	5.906	0.500	120	150	13
25003-6084	23	4.656	6.031	0.500	118	153	13	24638-2863	26	4.724	5.906	0.512	120	150	13
25003-3060	23	4.677	5.661	0.492	119	144	12	24620-2863	26R1	4.724	5.906	0.512	120	150	13
24802-3062	EQUAL	4.680	6.000	0.625	119	152	16	25003-5348	23	4.724	5.906	0.551	120	150	14
29502-6429	IG	4.681	5.587	0.750	119	142	19	25006-5348	23	4.724	5.906	0.551	120	150	14
29502-6349	IG	4.684	6.000	0.750	119	152	19	25003-7277	23	4.724	5.906	0.591	120	150	15
25004-6364	23	4.687	5.812	0.500	119	148	13	24612-7277	26	4.724	5.906	0.591	120	150	15
21086-2834	53	4.687	6.375	0.500	119	162	13	21096-7277	53	4.724	5.906	0.591	120	150	15
25003-1160	23	4.688	5.625	0.500	119	143	13	21086-7277	53	4.724	5.906	0.591	120	150	15
25003-6525	23	4.688	5.688	0.500	119	144	13	29602-4987	GD	4.724	5.906	0.700	120	150	18
25006-6525	23	4.688	5.688	0.500	119	144	13	29502-4987	IG	4.724	5.906	0.750	120	150	19
29502-4298	IG	4.688	5.688	0.750	119	144	19	29521-6545	IG	4.724	5.906	0.875	120	150	22
25003-2819	23	4.688	5.750	0.500	119	146	13	25003-7376	23	4.724	5.910	0.472	120	150	12
24626-2820	26	4.688	5.750	0.500	119	146	13	25003-1024	23	4.724	6.000	0.500	120	152	13
24600-2820	26	4.688	5.750	0.500	119	146	13	25003-1303	23	4.724	6.101	0.500	120	155	13
24610-2820	26	4.688	5.750	0.500	119	146	13	25003-7836	23	4.724	6.299	0.472	120	160	12
21096-2819	53	4.688	5.750	0.500	119	146	13	24626-7836	26	4.724	6.299	0.472	120	160	12
21087-2819	53	4.688	5.750	0.500	119	146	13	24600-7836	26	4.724	6.299	0.472	120	160	12
21086-2819	53	4.688	5.750	0.500	119	146	13	21096-7836	53	4.724	6.299	0.472	120	160	12
21699-2819	53	4.688	5.750	0.500	119	146	13	21086-7836	53	4.724	6.299	0.472	120	160	12
21086-2820	53	4.688	5.750	0.563	119	146	14	24612-2097	26	4.724	6.299	0.591	120	160	15
22897-5043	53T2	4.688	5.750	0.906	119	146	23	29500-7295	IG	4.724	6.500	0.750	120	165	19
25003-6364	23	4.688	5.813	0.500	119	148	13	24600-1855	26	4.724	5.512	0.512	120	140	13
25003-2822	23	4.688	5.875	0.500	119	149	13	21005-1862	58	4.724	5.512	0.512	120	140	13
21087-2822	53	4.688	5.875	0.500	119	149	13	24622-4382	26R1	4.724	5.906	0.472	120	150	12
21086-2822	53	4.688	5.875	0.500	119	149	13	21409-7376	53	4.724	5.906	0.472	120	150	12
21699-2822	53	4.688	5.875	0.500	119	149	13	24626-5348	26	4.724	5.906	0.551	120	150	14
25003-5058	23	4.688	5.938	0.500	119	151	13	24600-5348	26	4.724	5.906	0.551	120	150	14
21086-2825	53	4.688	6.000	0.500	119	152	13	24610-5348	26	4.724	5.906	0.551	120	150	14
23708-7348	53R2	4.688	6.000	0.906	119	152	23	24620-7277	26R1	4.724	5.906	0.591	120	150	15
21086-2831	53	4.688	6.250	0.500	119	159	13	24064-1880	61	4.725	5.906	0.512	120	150	13
24062-2831	61	4.688	6.250	0.500	119	159	13	24060-1880	61	4.725	5.906	0.512	120	150	13
29602-6508	GD	4.700	5.700	0.700	119	145	18	24802-3179	EQUAL	4.725	5.906	0.625	120	150	16
24801-4682	EQUAL	4.705	5.750	0.625	120	146	16	25003-7587	23	4.734	5.984	0.500	120	152	13
24060-3339	61	4.720	5.748	0.500	120	146	13	24620-2841	26R1	4.750	5.500	0.375	121	140	10
29502-6428	IG	4.720	6.000	0.750	120	152	19	24600-2841	26	4.750	5.500	0.375	121	140	10
29502-6533	IG	4.722	5.748	0.750	120	146	19	24612-2841	26	4.750	5.500	0.375	121	140	10
24807-4076	EQUAL	4.724	5.315	0.472	120	135	12	29502-5410	IG	4.750	5.500	0.750	121	140	19
24637-2835	26	4.724	5.512	0.394	120	140	10	24600-5439	26	4.750	5.625	0.437	121	143	11

All dimensions are in inches. Preferred sizes are indicated with **bold** type face.  
 Sizes listed are for standard nitrile elements, except Models 25 and 62 which have PTFE elements. Other material available on inquiry only.

## Oil Seals by Model Number

Product Code	Model	Inches			MM			Product Code	Model	Inches			MM		
		ID	OD	Width	ID	OD	Width			ID	OD	Width	ID	OD	Width
25003-5443	23	4.750	5.625	0.500	121	143	13	24824-2845	EQUAL	4.750	6.000	0.625	121	152	16
25003-5495	23	4.750	5.625	0.625	121	143	16	29502-4218	IG	4.750	6.000	0.750	121	152	19
25006-5495	23	4.750	5.625	0.625	121	143	16	22537-4836	53R1	4.750	6.000	0.906	121	152	23
24600-5495	26	4.750	5.625	0.625	121	143	16	22627-4836	53R2	4.750	6.000	0.906	121	152	23
25003-3800	23	4.750	5.675	0.500	121	144	13	25003-2846	23	4.750	6.125	0.500	121	156	13
25009-6213	23	4.750	5.750	0.375	121	146	10	21086-2846	53	4.750	6.125	0.500	121	156	13
25003-6213	23	4.750	5.750	0.375	121	146	10	25003-2849	23	4.750	6.250	0.500	121	159	13
25006-6213	23	4.750	5.750	0.375	121	146	10	21086-2849	53	4.750	6.250	0.500	121	159	13
25284-6213	23	4.750	5.750	0.375	121	146	10	21699-2849	53	4.750	6.250	0.500	121	159	13
25045-3162	23	4.750	5.750	0.484	121	146	12	21702-2849	62	4.750	6.250	0.500	121	159	13
25010-2837	23	4.750	5.750	0.500	121	146	13	24600-2851	26	4.750	6.250	0.625	121	159	16
25138-2837	23	4.750	5.750	0.500	121	146	13	29519-2851	IG	4.750	6.250	0.625	121	159	16
25003-2837	23	4.750	5.750	0.500	121	146	13	24801-2851	EQUAL	4.750	6.250	0.625	121	159	16
24627-2837	26	4.750	5.750	0.500	121	146	13	25003-4934	23	4.750	6.250	0.750	121	159	19
24600-2837	26	4.750	5.750	0.500	121	146	13	29502-6406	IG	4.750	6.250	0.750	121	159	19
24610-2837	26	4.750	5.750	0.500	121	146	13	21086-2852	53	4.750	6.375	0.500	121	162	13
21086-2837	53	4.750	5.750	0.500	121	146	13	24626-2853	26	4.750	6.500	0.625	121	165	16
21086-2837	53	4.750	5.750	0.500	121	146	13	24600-2853	26	4.750	6.500	0.625	121	165	16
21095-2837	53	4.750	5.750	0.500	121	146	13	21140-9986	54	4.750	9.250	0.625	121	235	16
21409-2837	53	4.750	5.750	0.500	121	146	13	29602-6933	GD	4.770	6.250	0.700	121	159	18
21699-2837	53	4.750	5.750	0.500	121	146	13	24801-3165	EQUAL	4.788	6.000	0.625	122	152	16
24064-2837	61	4.750	5.750	0.500	121	146	13	25003-2496	23	4.803	5.906	0.500	122	150	13
24060-2837	61	4.750	5.750	0.500	121	146	13	24801-3164	EQUAL	4.810	6.000	0.625	122	152	16
24063-2838	61	4.750	5.750	0.562	121	146	14	25003-4759	23	4.812	5.750	0.500	122	146	13
21086-2838	53	4.750	5.750	0.563	121	146	14	21086-2857	53	4.812	5.875	0.625	122	149	16
22500-2839	53G1	4.750	5.750	0.625	121	146	16	25003-8402	23	4.813	5.813	0.375	122	148	10
21086-2839	53	4.750	5.750	0.625	121	146	16	25003-6491	23	4.813	5.813	0.500	122	148	13
24801-2931	EQUAL	4.750	5.750	0.625	121	146	16	25003-2855	23	4.813	5.875	0.500	122	149	13
24802-2931	EQUAL	4.750	5.750	0.625	121	146	16	21086-2855	53	4.813	5.875	0.500	122	149	13
24803-2931	EQUAL	4.750	5.750	0.625	121	146	16	25003-3969	23	4.813	5.937	0.500	122	151	13
29602-4167	GD	4.750	5.750	0.700	121	146	18	25003-7857	23	4.813	5.938	0.375	122	151	10
29500-4167	IG	4.750	5.750	0.750	121	146	19	25003-2858	23	4.813	6.000	0.500	122	152	13
29502-4167	IG	4.750	5.750	0.750	121	146	19	21086-2858	53	4.813	6.000	0.500	122	152	13
22627-5285	53R2	4.750	5.750	0.938	121	146	24	25003-1248	23	4.813	6.007	0.375	122	153	10
24801-2510	EQUAL	4.750	5.756	0.625	121	146	16	25003-2861	23	4.813	6.125	0.500	122	156	13
25003-2840	23	4.750	5.875	0.500	121	149	13	21086-2864	53	4.813	6.250	0.500	122	159	13
24600-2840	26	4.750	5.875	0.500	121	149	13	25003-4536	23	4.813	6.313	0.500	122	160	13
21086-2840	53	4.750	5.875	0.500	121	149	13	25003-3852	23	4.815	5.815	0.500	122	148	13
21087-2840	53	4.750	5.875	0.500	121	149	13	29602-6991	GD	4.835	5.835	0.700	123	148	18
21086-2840	53	4.750	5.875	0.500	121	149	13	29502-4837	IG	4.851	5.886	0.750	123	150	19
21699-2840	53	4.750	5.875	0.500	121	149	13	29602-7344	GD	4.875	5.625	0.700	124	143	18
25003-6431	23	4.750	5.875	0.563	121	149	14	25003-5166	23	4.875	5.875	0.375	124	149	10
21086-2842	53	4.750	5.875	0.625	121	149	16	25006-5166	23	4.875	5.875	0.375	124	149	10
29502-7375	IG	4.750	5.875	0.750	121	149	19	25003-2870	23	4.875	5.875	0.500	124	149	13
25003-9839	23	4.750	5.938	0.500	121	151	13	25087-2870	23	4.875	5.875	0.500	124	149	13
25003-7795	23	4.750	6.000	0.375	121	152	10	25006-2870	23	4.875	5.875	0.500	124	149	13
25010-2843	23	4.750	6.000	0.500	121	152	13	25004-2870	23	4.875	5.875	0.500	124	149	13
25003-2843	23	4.750	6.000	0.500	121	152	13	25284-2870	23	4.875	5.875	0.500	124	149	13
25006-2843	23	4.750	6.000	0.500	121	152	13	24620-0664	26R1	4.875	5.875	0.500	124	149	13
24627-0943	26	4.750	6.000	0.500	121	152	13	21087-2870	53	4.875	5.875	0.500	124	149	13
21086-2843	53	4.750	6.000	0.500	121	152	13	21086-2870	53	4.875	5.875	0.500	124	149	13
24060-2843	61	4.750	6.000	0.500	121	152	13	21699-2870	53	4.875	5.875	0.500	124	149	13
24064-2843	61	4.750	6.000	0.500	121	152	13	21702-2870	62	4.875	5.875	0.500	124	149	13
24626-2845	26	4.750	6.000	0.625	121	152	16	24802-2048	EQUAL	4.875	5.875	0.625	124	149	16
24600-2845	26	4.750	6.000	0.625	121	152	16	29602-4168	GD	4.875	5.875	0.700	124	149	18
21086-2845	53	4.750	6.000	0.625	121	152	16	29502-4168	IG	4.875	5.875	0.750	124	149	19

All dimensions are in inches. Preferred sizes are indicated with **bold** type face.

Sizes listed are for standard nitrile elements, except Models 25 and 62 which have PTFE elements. Other material available on inquiry only.

## Oil Seals by Model Number

Product Code	Model	Inches			MM			Product Code	Model	Inches			MM		
		ID	OD	Width	ID	OD	Width			ID	OD	Width	ID	OD	Width
25135-5880	23	4.875	5.938	0.500	124	151	13	25003-2887	23	4.921	5.906	0.472	125	150	12
25003-5880	23	4.875	5.938	0.500	124	151	13	24063-2811	61	4.921	5.906	0.500	125	150	13
29516-7089	IG	4.875	5.980	1.062	124	152	27	24626-4558	26	4.921	5.906	0.512	125	150	13
24816-7007	EQUAL	4.875	5.983	1.375	124	152	35	24600-4558	26	4.921	5.906	0.512	125	150	13
25010-2873	23	4.875	6.000	0.500	124	152	13	25003-1259	23	4.921	5.906	0.591	125	150	15
25003-2873	23	4.875	6.000	0.500	124	152	13	29502-4989	IG	4.921	5.906	0.750	125	150	19
21087-2873	53	4.875	6.000	0.500	124	152	13	25003-5354	23	4.921	6.102	0.551	125	155	14
21086-2873	53	4.875	6.000	0.500	124	152	13	24620-5354	26R1	4.921	6.102	0.551	125	155	14
21699-2873	53	4.875	6.000	0.500	124	152	13	24629-5354	26R1	4.921	6.102	0.552	125	155	14
25003-2875	23	4.875	6.000	0.625	124	152	16	24801-5089	EQUAL	4.921	6.102	0.625	125	155	16
24626-2875	26	4.875	6.000	0.625	124	152	16	29502-6440	IG	4.921	6.181	0.750	125	157	19
24600-2875	26	4.875	6.000	0.625	124	152	16	29513-6440	IG	4.921	6.181	0.750	125	157	19
22501-2875	53G1	4.875	6.000	0.625	124	152	16	29518-6462	IG	4.921	6.181	0.875	125	157	22
21086-2875	53	4.875	6.000	0.625	124	152	16	21096-4649	53	4.921	6.299	0.591	125	160	15
24801-2875	EQUAL	4.875	6.000	0.625	124	152	16	25003-1397	23	4.921	6.299	0.709	125	160	18
24802-2875	EQUAL	4.875	6.000	0.625	124	152	16	24801-2930	EQUAL	4.921	6.890	0.625	125	175	16
29502-5227	IG	4.875	6.000	0.750	124	152	19	29516-7185	IG	4.921	7.382	0.804	125	188	20
22627-8630	53R2	4.875	6.000	0.906	124	152	23	24602-5690	26	4.921	5.906	0.394	125	150	10
22897-8630	53T2	4.875	6.000	0.906	124	152	23	24602-2887	26	4.921	5.906	0.472	125	150	12
25003-2876	23	4.875	6.125	0.500	124	156	13	25003-2293	23	4.921	6.299	0.512	125	160	13
21086-2876	53	4.875	6.125	0.500	124	156	13	24600-2889	26	4.921	6.299	0.591	125	160	15
21086-2878	53	4.875	6.125	0.625	124	156	16	24620-2890	26R1	4.921	6.693	0.472	125	170	12
29602-7520	GD	4.875	6.125	0.700	124	156	18	24610-2890	26	4.921	6.693	0.472	125	170	12
25003-2879	23	4.875	6.250	0.500	124	159	13	21003-2887	58	4.922	5.906	0.473	125	150	12
25005-2879	24	4.875	6.250	0.500	124	159	13	25003-5459	23	4.922	5.922	0.500	125	150	13
24600-2879	26	4.875	6.250	0.500	124	159	13	25006-5459	23	4.922	5.922	0.500	125	150	13
24602-2879	26	4.875	6.250	0.500	124	159	13	29516-7366	IG	4.922	5.984	1.228	125	152	31
21086-2879	53	4.875	6.250	0.500	124	159	13	25003-5377	23	4.922	6.063	0.487	125	154	12
21699-2879	53	4.875	6.250	0.500	124	159	13	24801-3790	EQUAL	4.935	6.000	0.625	125	152	16
21527-2879	66	4.875	6.250	0.500	124	159	13	25003-9791	23	4.937	6.062	0.500	125	154	13
25003-2880	23	4.875	6.250	0.563	124	159	14	29507-5563	IG	4.938	5.500	0.625	125	140	16
24600-2881	26	4.875	6.250	0.625	124	159	16	24807-4652	EQUAL	4.938	5.500	0.690	125	140	18
21086-2881	53	4.875	6.250	0.625	124	159	16	25003-2910	23	4.938	5.875	0.500	125	149	13
24600-2886	26	4.875	6.250	0.858	124	159	22	25003-6754	23	4.938	5.938	0.375	125	151	10
25003-2882	23	4.875	6.375	0.500	124	162	13	25003-2893	23	4.938	5.938	0.438	125	151	11
25284-2882	23	4.875	6.375	0.500	124	162	13	25010-6561	23	4.938	5.938	0.500	125	151	13
21086-2882	53	4.875	6.375	0.500	124	162	13	25003-6561	23	4.938	5.938	0.500	125	151	13
24824-3147	EQUAL	4.875	6.375	0.625	124	162	16	25006-6561	23	4.938	5.938	0.500	125	151	13
21086-2885	53	4.875	6.500	0.500	124	165	13	24610-0665	26	4.938	5.938	0.500	125	151	13
22627-6814	53R2	4.875	6.500	0.906	124	165	23	24612-0665	26	4.938	5.938	0.500	125	151	13
21086-2888	53	4.875	6.625	0.500	124	168	13	24802-2539	EQUAL	4.938	5.938	0.625	125	151	16
21699-2888	53	4.875	6.625	0.500	124	168	13	29502-4300	IG	4.938	5.938	0.750	125	151	19
22897-6463	53T2	4.875	6.625	0.906	124	168	23	29522-4300	IG	4.938	5.938	0.750	125	151	19
22897-4708	53T2	4.875	6.625	0.969	124	168	25	29516-7100	IG	4.938	5.980	1.056	125	152	27
21086-2891	53	4.875	6.750	0.500	124	171	13	24816-7029	EQUAL	4.938	5.982	1.375	125	152	35
29500-5119	IG	4.875	7.000	0.750	124	178	19	25003-8629	23	4.938	6.000	0.375	125	152	10
29602-7225	GD	4.877	5.877	0.700	124	149	18	25003-2894	23	4.938	6.000	0.500	125	152	13
29602-6695	GD	4.882	5.882	0.700	124	149	18	25006-2894	23	4.938	6.000	0.500	125	152	13
25003-1707	23	4.882	6.299	0.413	124	160	10	24629-2894	26R1	4.938	6.000	0.500	125	152	13
29602-6897	GD	4.888	5.888	0.700	124	150	18	21096-2894	53	4.938	6.000	0.500	125	152	13
29602-6742	GD	4.903	5.903	0.700	125	150	18	21087-2894	53	4.938	6.000	0.500	125	152	13
25009-2024	23	4.910	5.910	0.500	125	150	13	21086-2894	53	4.938	6.000	0.500	125	152	13
25003-2024	23	4.910	5.910	0.500	125	150	13	21947-2894	53	4.938	6.000	0.500	125	152	13
21697-7703	111	4.919	5.495	0.625	125	140	16	21699-2894	53	4.938	6.000	0.500	125	152	13
25003-6638	23	4.920	6.125	0.438	125	156	11	21086-2896	53	4.938	6.000	0.625	125	152	16
25010-2887	23	4.921	5.906	0.472	125	150	12	24802-2896	EQUAL	4.938	6.000	0.625	125	152	16

All dimensions are in inches. Preferred sizes are indicated with **bold** type face. Sizes listed are for standard nitrile elements, except Models 25 and 62 which have PTFE elements. Other material available on inquiry only.

## Oil Seals by Model Number

Product Code	Model	Inches			MM			Product Code	Model	Inches			MM		
		ID	OD	Width	ID	OD	Width			ID	OD	Width	ID	OD	Width
29602-4472	GD	4.938	6.000	0.700	125	152	18	25003-3569	23	5.000	5.938	0.500	127	151	13
29500-4472	IG	4.938	6.000	0.750	125	152	19	29516-7102	IG	5.000	5.980	1.053	127	152	27
29502-4472	IG	4.938	6.000	0.750	125	152	19	24816-7030	EQUAL	5.000	5.982	1.375	127	152	35
21086-2897	53	4.938	6.125	0.500	125	156	13	25003-6365	23	5.000	6.000	0.375	127	152	10
25003-5138	23	4.938	6.188	0.500	125	157	13	25006-6365	23	5.000	6.000	0.375	127	152	10
24610-6243	26	4.938	6.188	0.500	125	157	13	25004-6365	23	5.000	6.000	0.375	127	152	10
29609-7250	GD	4.938	6.250	0.375	125	159	10	25009-6365	23	5.000	6.000	0.375	127	152	10
25010-2900	23	4.938	6.250	0.500	125	159	13	25003-9389	23	5.000	6.000	0.438	127	152	11
25003-2900	23	4.938	6.250	0.500	125	159	13	24128-2611	61	5.000	6.000	0.469	127	152	12
25006-2900	23	4.938	6.250	0.500	125	159	13	25001-2915	21	5.000	6.000	0.500	127	152	13
24626-2900	26	4.938	6.250	0.500	125	159	13	25010-2915	23	5.000	6.000	0.500	127	152	13
24600-2900	26	4.938	6.250	0.500	125	159	13	25087-2915	23	5.000	6.000	0.500	127	152	13
21096-2900	53	4.938	6.250	0.500	125	159	13	25003-2915	23	5.000	6.000	0.500	127	152	13
21087-2900	53	4.938	6.250	0.500	125	159	13	25045-2915	23	5.000	6.000	0.500	127	152	13
21086-2900	53	4.938	6.250	0.500	125	159	13	25006-2915	23	5.000	6.000	0.500	127	152	13
21409-2900	53	4.938	6.250	0.500	125	159	13	25004-2915	23	5.000	6.000	0.500	127	152	13
21699-2900	53	4.938	6.250	0.500	125	159	13	25058-2915	25	5.000	6.000	0.500	127	152	13
21086-2901	53	4.938	6.250	0.563	125	159	14	25007-2915	25	5.000	6.000	0.500	127	152	13
25003-2903	23	4.938	6.375	0.500	125	162	13	24652-2915	26NS	5.000	6.000	0.500	127	152	13
21086-2903	53	4.938	6.375	0.500	125	162	13	24620-2915	26R1	5.000	6.000	0.500	127	152	13
25003-2904	23	4.938	6.375	0.563	125	162	14	24600-2915	26	5.000	6.000	0.500	127	152	13
25003-7867	23	4.938	6.438	0.500	125	164	13	24610-2915	26	5.000	6.000	0.500	127	152	13
24608-5499	26	4.938	6.438	0.500	125	164	13	24626-2915	26	5.000	6.000	0.500	127	152	13
24627-3192	26	4.938	6.438	0.750	125	164	19	21096-2915	53	5.000	6.000	0.500	127	152	13
21096-2906	53	4.938	6.500	0.500	125	165	13	21087-2915	53	5.000	6.000	0.500	127	152	13
21086-2906	53	4.938	6.500	0.500	125	165	13	21086-2915	53	5.000	6.000	0.500	127	152	13
21086-2908	53	4.938	6.500	0.625	125	165	16	21699-2915	53	5.000	6.000	0.500	127	152	13
24824-3371	EQUAL	4.938	6.500	0.625	125	165	16	24067-2915	61	5.000	6.000	0.500	127	152	13
22987-6902	53F1	4.938	6.500	0.719	125	165	18	24062-2915	61	5.000	6.000	0.500	127	152	13
22627-7315	53R2	4.938	6.500	0.906	125	165	23	24060-2915	61	5.000	6.000	0.500	127	152	13
21086-2912	53	4.938	6.750	0.500	125	171	13	21767-2915	62	5.000	6.000	0.500	127	152	13
29516-7123	IG	4.938	6.988	0.827	125	177	21	21702-2915	62	5.000	6.000	0.500	127	152	13
29500-4647	IG	4.938	7.000	0.750	125	178	19	21086-2916	53	5.000	6.000	0.563	127	152	14
29516-7134	IG	4.938	7.382	0.918	125	188	23	22502-2917	53G1	5.000	6.000	0.625	127	152	16
25003-1025	23	4.960	5.885	0.500	126	149	13	21597-2917	53	5.000	6.000	0.625	127	152	16
25003-3389	23	4.961	6.024	0.500	126	153	13	21086-2917	53	5.000	6.000	0.625	127	152	16
25003-9372	23	4.969	6.375	0.500	126	162	13	29519-2917	IG	5.000	6.000	0.625	127	152	16
25003-9268	23	4.984	6.234	0.500	127	158	13	29607-2917	GD	5.000	6.000	0.625	127	152	16
25003-2518	23	4.987	6.000	0.500	127	152	13	24802-2917	EQUAL	5.000	6.000	0.625	127	152	16
24626-2913	26	4.987	6.000	0.500	127	152	13	24821-2915	EQUAL	5.000	6.000	0.625	127	152	16
24600-2913	26	4.987	6.000	0.500	127	152	13	24843-2917	EQUAL	5.000	6.000	0.625	127	152	16
29602-6727	GD	4.998	6.249	0.700	127	159	18	25003-5585	23	5.000	6.000	0.687	127	152	17
29602-6634	GD	4.998	6.429	0.700	127	163	18	29602-4169	GD	5.000	6.000	0.700	127	152	18
21003-2710	58	4.999	5.905	0.512	127	150	13	22987-6603	53F1	5.000	6.000	0.719	127	152	18
24610-2925	26	5.000	5.750	0.375	127	146	10	29502-4169	IG	5.000	6.000	0.750	127	152	19
24626-2932	26	5.000	5.750	0.437	127	146	11	29519-4169	IG	5.000	6.000	0.750	127	152	19
24600-2932	26	5.000	5.750	0.437	127	146	11	29520-4169	IG	5.000	6.000	0.750	127	152	19
24610-2932	26	5.000	5.750	0.437	127	146	11	29521-6014	IG	5.000	6.000	0.875	127	152	22
24060-1966	61	5.000	5.750	0.500	127	146	13	22537-6711	53R1	5.000	6.000	0.906	127	152	23
24801-1051	EQUAL	5.000	5.750	0.500	127	146	13	22627-6711	53R2	5.000	6.000	0.906	127	152	23
25009-9702	23	5.000	5.875	0.375	127	149	10	22627-6640	53R2	5.000	6.000	0.969	127	152	25
25003-9702	23	5.000	5.875	0.375	127	149	10	22897-6640	53T2	5.000	6.000	0.969	127	152	25
25006-9702	23	5.000	5.875	0.375	127	149	10	25003-5222	23	5.000	6.062	0.500	127	154	13
25284-9702	23	5.000	5.875	0.375	127	149	10	25003-2918	23	5.000	6.125	0.500	127	156	13
25284-3786	23	5.000	5.875	0.395	127	149	10	25004-2918	23	5.000	6.125	0.500	127	156	13
25003-2974	23	5.000	5.875	0.500	127	149	13	25058-2918	25	5.000	6.125	0.500	127	156	13

All dimensions are in inches. Preferred sizes are indicated with **bold** type face.

Sizes listed are for standard nitrile elements, except Models 25 and 62 which have PTFE elements. Other material available on inquiry only.

## Oil Seals by Model Number

Product Code	Model	Inches			MM			Product Code	Model	Inches			MM		
		ID	OD	Width	ID	OD	Width			ID	OD	Width	ID	OD	Width
21087-2918	53	5.000	6.125	0.500	127	156	13	21096-2924	53	5.000	6.375	0.500	127	162	13
21086-2918	53	5.000	6.125	0.500	127	156	13	21086-2924	53	5.000	6.375	0.500	127	162	13
21095-2918	53	5.000	6.125	0.500	127	156	13	21699-2924	53	5.000	6.375	0.500	127	162	13
21699-2918	53	5.000	6.125	0.500	127	156	13	25003-2926	23	5.000	6.375	0.625	127	162	16
25003-2919	23	5.000	6.125	0.563	127	156	14	24610-3785	26	5.000	6.375	0.625	127	162	16
25010-2921	23	5.000	6.250	0.500	127	159	13	21086-2926	53	5.000	6.375	0.625	127	162	16
25003-2921	23	5.000	6.250	0.500	127	159	13	24801-3785	EQUAL	5.000	6.375	0.625	127	162	16
25006-2921	23	5.000	6.250	0.500	127	159	13	24802-3785	EQUAL	5.000	6.375	0.625	127	162	16
25004-2921	23	5.000	6.250	0.500	127	159	13	25003-9483	23	5.000	6.375	0.750	127	162	19
24620-2921	26R1	5.000	6.250	0.500	127	159	13	25058-2973	25	5.000	6.437	0.500	127	163	13
24626-2921	26	5.000	6.250	0.500	127	159	13	25003-6453	23	5.000	6.500	0.375	127	165	10
24627-2921	26	5.000	6.250	0.500	127	159	13	25003-2927	23	5.000	6.500	0.500	127	165	13
24600-2921	26	5.000	6.250	0.500	127	159	13	21086-2927	53	5.000	6.500	0.500	127	165	13
24610-2921	26	5.000	6.250	0.500	127	159	13	21699-2927	53	5.000	6.500	0.500	127	165	13
21096-2921	53	5.000	6.250	0.500	127	159	13	21702-2927	62	5.000	6.500	0.500	127	165	13
21086-2921	53	5.000	6.250	0.500	127	159	13	24626-2928	26	5.000	6.500	0.562	127	165	14
21699-2921	53	5.000	6.250	0.500	127	159	13	24627-2928	26	5.000	6.500	0.562	127	165	14
26063-2921	57	5.000	6.250	0.500	127	159	13	25003-2928	23	5.000	6.500	0.563	127	165	14
26057-2921	57	5.000	6.250	0.500	127	159	13	25006-2928	23	5.000	6.500	0.563	127	165	14
26058-2921	57	5.000	6.250	0.500	127	159	13	24600-2928	26	5.000	6.500	0.563	127	165	14
24060-2921	61	5.000	6.250	0.500	127	159	13	25006-2929	23	5.000	6.500	0.625	127	165	16
21702-2921	62	5.000	6.250	0.500	127	159	13	24610-2929	26	5.000	6.500	0.625	127	165	16
25003-2922	23	5.000	6.250	0.562	127	159	14	21086-2929	53	5.000	6.500	0.625	127	165	16
24600-2922	26	5.000	6.250	0.562	127	159	14	24822-2929	EQUAL	5.000	6.500	0.625	127	165	16
21096-2922	53	5.000	6.250	0.562	127	159	14	25003-6939	23	5.000	6.500	0.750	127	165	19
24610-2922	26	5.000	6.250	0.563	127	159	14	25284-6939	23	5.000	6.500	0.750	127	165	19
21087-2922	53	5.000	6.250	0.563	127	159	14	24627-3211	26	5.000	6.500	0.750	127	165	19
21086-2922	53	5.000	6.250	0.563	127	159	14	22627-4668	53R2	5.000	6.500	0.906	127	165	23
21947-2922	53	5.000	6.250	0.563	127	159	14	22897-4668	53T2	5.000	6.500	0.906	127	165	23
21699-2922	53	5.000	6.250	0.563	127	159	14	25005-9930	24	5.000	6.563	0.500	127	167	13
25045-2923	23	5.000	6.250	0.625	127	159	16	21096-2930	53	5.000	6.625	0.500	127	168	13
25003-2923	23	5.000	6.250	0.625	127	159	16	21086-2930	53	5.000	6.625	0.500	127	168	13
25056-2923	25	5.000	6.250	0.625	127	159	16	24610-3477	26	5.000	6.750	0.500	127	171	13
25058-2923	25	5.000	6.250	0.625	127	159	16	21086-2933	53	5.000	6.750	0.500	127	171	13
24620-2923	26R1	5.000	6.250	0.625	127	159	16	26058-2933	57	5.000	6.750	0.500	127	171	13
24626-2923	26	5.000	6.250	0.625	127	159	16	26063-2933	57	5.000	6.750	0.500	127	171	13
24627-2923	26	5.000	6.250	0.625	127	159	16	26057-2933	57	5.000	6.750	0.500	127	171	13
24600-2923	26	5.000	6.250	0.625	127	159	16	21086-2935	53	5.000	6.750	0.625	127	171	16
24610-2923	26	5.000	6.250	0.625	127	159	16	29602-6643	GD	5.000	6.800	0.700	127	173	18
22501-2923	53G1	5.000	6.250	0.625	127	159	16	21086-2936	53	5.000	6.875	0.500	127	175	13
21096-2923	53	5.000	6.250	0.625	127	159	16	21086-2939	53	5.000	7.000	0.500	127	178	13
21087-2923	53	5.000	6.250	0.625	127	159	16	21086-2941	53	5.000	7.000	0.625	127	178	16
21086-2923	53	5.000	6.250	0.625	127	159	16	29500-5645	IG	5.000	7.000	0.750	127	178	19
29519-2923	IG	5.000	6.250	0.625	127	159	16	21086-2942	53	5.000	7.125	0.500	127	181	13
24801-2923	EQUAL	5.000	6.250	0.625	127	159	16	21096-2945	53	5.000	7.250	0.500	127	184	13
24802-2923	EQUAL	5.000	6.250	0.625	127	159	16	21086-2945	53	5.000	7.250	0.500	127	184	13
29602-4203	GD	5.000	6.250	0.700	127	159	18	21086-2948	53	5.000	7.375	0.500	127	187	13
29500-4203	IG	5.000	6.250	0.750	127	159	19	21086-2951	53	5.000	7.500	0.500	127	191	13
29502-4203	IG	5.000	6.250	0.750	127	159	19	21140-6018	54	5.000	9.750	0.625	127	248	16
29518-6315	IG	5.000	6.250	0.875	127	159	22	29502-6329	IG	5.039	5.906	0.750	128	150	19
22627-4828	53R2	5.000	6.250	0.906	127	159	23	25003-0419	23	5.060	5.934	0.375	129	151	10
22897-6893	53T2	5.000	6.250	0.969	127	159	25	24627-0666	26	5.062	6.062	0.500	129	154	13
24802-2924	EQUAL	5.000	6.256	0.625	127	159	16	21095-2954	53	5.062	6.125	0.500	129	156	13
21333-3022	143	5.000	6.312	0.781	127	160	20	21699-2954	53	5.062	6.125	0.500	129	156	13
25003-2924	23	5.000	6.375	0.500	127	162	13	21087-2957	53	5.062	6.250	0.500	129	159	13
25284-2924	23	5.000	6.375	0.500	127	162	13	21086-2957	53	5.062	6.250	0.500	129	159	13

All dimensions are in inches. Preferred sizes are indicated with **bold** type face. Sizes listed are for standard nitrile elements, except Models 25 and 62 which have PTFE elements. Other material available on inquiry only.

## Oil Seals by Model Number

Product Code	Model	Inches			MM			Product Code	Model	Inches			MM		
		ID	OD	Width	ID	OD	Width			ID	OD	Width	ID	OD	Width
25003-6147	23	5.062	6.375	0.563	129	162	14	24610-2989	26	5.118	6.299	0.551	130	160	14
25003-6485	23	5.063	6.062	0.500	129	154	13	24600-2988	26	5.118	6.299	0.591	130	160	15
29502-4301	IG	5.063	6.063	0.750	129	154	19	24602-2988	26	5.118	6.299	0.591	130	160	15
25003-2954	23	5.063	6.125	0.500	129	156	13	24804-3022	EQUAL	5.118	6.299	0.625	130	160	16
24600-3583	26	5.063	6.125	0.500	129	156	13	24610-2988	26	5.119	6.300	0.591	130	160	15
21597-2954	53	5.063	6.125	0.500	129	156	13	25003-2274	23	5.125	6.000	0.500	130	152	13
21086-2954	53	5.063	6.125	0.500	129	156	13	29699-0010	GD	5.125	6.000	0.888	130	152	23
29500-6445	IG	5.063	6.125	0.750	129	156	19	25010-5189	23	5.125	6.125	0.375	130	156	10
21086-2969	53	5.063	6.750	0.500	129	171	13	25003-5189	23	5.125	6.125	0.375	130	156	10
27223-6329	94	5.063	7.875	0.500	129	200	13	25006-5189	23	5.125	6.125	0.375	130	156	10
24802-2986	EQUAL	5.088	6.088	0.625	129	155	16	25004-5189	23	5.125	6.125	0.375	130	156	10
25009-1229	23	5.094	6.586	0.484	129	167	12	25003-6392	23	5.125	6.125	0.422	130	156	11
25003-1229	23	5.094	6.586	0.484	129	167	12	25003-6198	23	5.125	6.125	0.438	130	156	11
25003-0581	23	5.098	6.598	0.500	129	168	13	25010-2990	23	5.125	6.125	0.500	130	156	13
29602-6947	GD	5.100	6.125	0.700	130	156	18	25003-2990	23	5.125	6.125	0.500	130	156	13
29519-6517	IG	5.105	6.105	0.625	130	155	16	25006-2990	23	5.125	6.125	0.500	130	156	13
29519-6883	IG	5.110	6.120	0.625	130	155	16	24627-2990	26	5.125	6.125	0.500	130	156	13
25003-5490	23	5.115	6.115	0.500	130	155	13	24600-2990	26	5.125	6.125	0.500	130	156	13
25006-5490	23	5.115	6.115	0.500	130	155	13	21087-2990	53	5.125	6.125	0.500	130	156	13
24802-3095	EQUAL	5.115	6.115	0.625	130	155	16	21086-2990	53	5.125	6.125	0.500	130	156	13
29619-6862	GD	5.117	6.438	0.625	130	164	16	21091-2990	53	5.125	6.125	0.500	130	156	13
25003-5797	23	5.118	5.992	0.375	130	152	10	21095-2990	53	5.125	6.125	0.500	130	156	13
25003-0926	23	5.118	6.118	0.375	130	155	10	21947-2990	53	5.125	6.125	0.500	130	156	13
25003-5388	23	5.118	6.118	0.500	130	155	13	21699-2990	53	5.125	6.125	0.500	130	156	13
24822-3727	EQUAL	5.118	6.118	0.625	130	155	16	21086-2992	53	5.125	6.125	0.625	130	156	16
29504-5627	IG	5.118	6.118	0.750	130	155	19	29502-4170	IG	5.125	6.125	0.750	130	156	19
25010-5367	23	5.118	6.259	0.472	130	159	12	22537-6432	53R1	5.125	6.125	0.844	130	156	21
25003-5367	23	5.118	6.259	0.472	130	159	12	22627-6432	53R2	5.125	6.125	0.844	130	156	21
25006-5367	23	5.118	6.259	0.472	130	159	12	22897-7347	53T2	5.125	6.125	0.906	130	156	23
25003-1002	23	5.118	6.260	0.488	130	159	12	22897-7365	53T2	5.125	6.125	0.969	130	156	25
29602-6741	GD	5.118	6.274	0.700	130	159	18	25003-2993	23	5.125	6.250	0.500	130	159	13
25010-4656	23	5.118	6.299	0.472	130	160	12	21086-2993	53	5.125	6.250	0.500	130	159	13
25003-4656	23	5.118	6.299	0.472	130	160	12	24703-0951	59	5.125	6.250	0.500	130	159	13
24626-5422	26	5.118	6.299	0.472	130	160	12	25003-2994	23	5.125	6.250	0.563	130	159	14
24612-5422	26	5.118	6.299	0.472	130	160	12	21086-2994	53	5.125	6.250	0.563	130	159	14
25003-7221	23	5.118	6.299	0.511	130	160	13	24832-1085	EQUAL	5.125	6.250	0.625	130	159	16
24638-2989	26	5.118	6.299	0.551	130	160	14	25003-2996	23	5.125	6.375	0.500	130	162	13
24629-2989	26R1	5.118	6.299	0.551	130	160	14	24610-0952	26	5.125	6.375	0.500	130	162	13
21003-2989	58	5.118	6.299	0.551	130	160	14	21086-2996	53	5.125	6.375	0.500	130	162	13
24635-2988	26NS	5.118	6.299	0.590	130	160	15	25003-2997	23	5.125	6.375	0.563	130	162	14
25003-2988	23	5.118	6.299	0.591	130	160	15	24602-2997	26	5.125	6.375	0.563	130	162	14
24626-2988	26	5.118	6.299	0.591	130	160	15	21087-2997	53	5.125	6.375	0.563	130	162	14
29519-3022	IG	5.118	6.299	0.625	130	160	16	21086-2997	53	5.125	6.375	0.563	130	162	14
29619-3022	GD	5.118	6.299	0.625	130	160	16	25003-2998	23	5.125	6.375	0.625	130	162	16
29619-4991	GD	5.118	6.299	0.625	130	160	16	24626-2998	26	5.125	6.375	0.625	130	162	16
24802-3022	EQUAL	5.118	6.299	0.625	130	160	16	24600-2998	26	5.125	6.375	0.625	130	162	16
29602-4991	GD	5.118	6.299	0.700	130	160	18	21086-2998	53	5.125	6.375	0.625	130	162	16
29620-4991	GD	5.118	6.299	0.700	130	160	18	24802-2998	EQUAL	5.125	6.375	0.625	130	162	16
29502-4991	IG	5.118	6.299	0.750	130	160	19	25003-1665	23	5.125	6.500	0.375	130	165	10
24610-6178	26	5.118	6.693	0.630	130	170	16	25003-2999	23	5.125	6.500	0.500	130	165	13
29602-6527	GD	5.118	7.087	0.700	130	180	18	21086-2999	53	5.125	6.500	0.500	130	165	13
29502-6353	IG	5.118	5.906	0.748	130	150	19	25003-3001	23	5.125	6.500	0.625	130	165	16
24600-5422	26	5.118	6.299	0.472	130	160	12	25004-3001	23	5.125	6.500	0.625	130	165	16
26058-4656	57	5.118	6.299	0.472	130	160	12	21086-3001	53	5.125	6.500	0.625	130	165	16
26056-4656	57	5.118	6.299	0.472	130	160	12	21095-3001	53	5.125	6.500	0.625	130	165	16
24620-2989	26R1	5.118	6.299	0.551	130	160	14	21699-3001	53	5.125	6.500	0.625	130	165	16

All dimensions are in inches. Preferred sizes are indicated with **bold** type face.

Sizes listed are for standard nitrile elements, except Models 25 and 62 which have PTFE elements. Other material available on inquiry only.

## Oil Seals by Model Number

Product Code	Model	Inches			MM			Product Code	Model	Inches			MM		
		ID	OD	Width	ID	OD	Width			ID	OD	Width	ID	OD	Width
22627-4982	53R2	5.125	6.500	0.906	130	165	23	21087-3059	53	5.250	6.250	0.500	133	159	13
25003-9541	23	5.125	6.625	0.484	130	168	12	21557-3059	53	5.250	6.250	0.500	133	159	13
21086-3002	53	5.125	6.625	0.500	130	168	13	21086-3059	53	5.250	6.250	0.500	133	159	13
25003-8137	23	5.125	6.625	0.750	130	168	19	21806-3059	53	5.250	6.250	0.500	133	159	13
24610-3207	26	5.125	6.625	0.750	130	168	19	21095-3059	53	5.250	6.250	0.500	133	159	13
21086-3005	53	5.125	6.750	0.500	130	171	13	21947-3059	53	5.250	6.250	0.500	133	159	13
21086-3011	53	5.125	7.000	0.500	130	178	13	21699-3059	53	5.250	6.250	0.500	133	159	13
21699-3011	53	5.125	7.000	0.500	130	178	13	21003-3059	58	5.250	6.250	0.500	133	159	13
21086-3013	53	5.125	7.000	0.625	130	178	16	24801-5792	EQUAL	5.250	6.250	0.625	133	159	16
21086-3017	53	5.125	7.250	0.500	130	184	13	24802-2270	EQUAL	5.250	6.250	0.625	133	159	16
25001-3023	21	5.125	7.500	0.500	130	191	13	24821-2270	EQUAL	5.250	6.250	0.625	133	159	16
21086-3023	53	5.125	7.500	0.500	130	191	13	29502-4171	IG	5.250	6.250	0.750	133	159	19
21086-3025	53	5.125	7.500	0.625	130	191	16	29522-4171	IG	5.250	6.250	0.750	133	159	19
21086-3038	53	5.187	6.750	0.500	132	171	13	24801-3063	EQUAL	5.250	6.256	0.625	133	159	16
29602-5385	GD	5.187	7.000	0.700	132	178	18	25003-3062	23	5.250	6.375	0.500	133	162	13
29500-5385	IG	5.187	7.000	0.750	132	178	19	21096-3062	53	5.250	6.375	0.500	133	162	13
29502-5385	IG	5.187	7.000	0.750	132	178	19	21086-3062	53	5.250	6.375	0.500	133	162	13
25003-4660	23	5.188	6.188	0.500	132	157	13	21699-3062	53	5.250	6.375	0.500	133	162	13
24801-2766	EQUAL	5.188	6.188	0.625	132	157	16	24803-3669	EQUAL	5.250	6.375	0.625	133	162	16
25003-3026	23	5.188	6.250	0.500	132	159	13	24820-3669	EQUAL	5.250	6.375	0.625	133	162	16
24620-3026	26R1	5.188	6.250	0.500	132	159	13	24821-3669	EQUAL	5.250	6.375	0.625	133	162	16
24600-3026	26	5.188	6.250	0.500	132	159	13	25003-5697	23	5.250	6.437	0.375	133	163	10
21086-3026	53	5.188	6.250	0.500	132	159	13	25003-5696	23	5.250	6.437	0.500	133	163	13
21086-3026	53	5.188	6.250	0.500	132	159	13	25004-5696	23	5.250	6.437	0.500	133	163	13
21699-3026	53	5.188	6.250	0.500	132	159	13	25010-3065	23	5.250	6.500	0.500	133	165	13
22500-3046	53G1	5.188	6.250	0.625	132	159	16	25003-3065	23	5.250	6.500	0.500	133	165	13
25003-3029	23	5.188	6.375	0.500	132	162	13	25006-3065	23	5.250	6.500	0.500	133	165	13
21086-3029	53	5.188	6.375	0.500	132	162	13	25004-3065	23	5.250	6.500	0.500	133	165	13
29516-5311	IG	5.188	6.375	1.113	132	162	28	24629-3065	26R1	5.250	6.500	0.500	133	165	13
25003-8215	23	5.188	6.438	0.500	132	164	13	24620-3065	26R1	5.250	6.500	0.500	133	165	13
25003-6136	23	5.188	6.438	0.625	132	164	16	24606-3065	26R1	5.250	6.500	0.500	133	165	13
25003-3032	23	5.188	6.500	0.500	132	165	13	24627-3065	26	5.250	6.500	0.500	133	165	13
21086-3032	53	5.188	6.500	0.500	132	165	13	24610-3065	26	5.250	6.500	0.500	133	165	13
21086-3034	53	5.188	6.500	0.625	132	165	16	21086-3065	53	5.250	6.500	0.500	133	165	13
21086-3035	53	5.188	6.625	0.500	132	168	13	21699-3065	53	5.250	6.500	0.500	133	165	13
21699-3035	53	5.188	6.625	0.500	132	168	13	26057-3065	57	5.250	6.500	0.500	133	165	13
21086-3044	53	5.188	7.000	0.500	132	178	13	24060-3065	61	5.250	6.500	0.500	133	165	13
21086-3056	53	5.188	7.500	0.500	132	191	13	25003-3067	23	5.250	6.500	0.625	133	165	16
25003-9275	23	5.196	6.299	0.500	132	160	13	25144-3067	23	5.250	6.500	0.625	133	165	16
25003-5516	23	5.203	6.312	0.500	132	160	13	25004-3067	23	5.250	6.500	0.625	133	165	16
25003-6579	23	5.225	6.225	0.500	133	158	13	24600-3067	26	5.250	6.500	0.625	133	165	16
25003-3163	23	5.225	6.513	0.625	133	165	16	21086-3067	53	5.250	6.500	0.625	133	165	16
29602-6478	GD	5.244	6.244	0.700	133	159	18	24751-3067	59G1	5.250	6.500	0.625	133	165	16
24600-5457	26	5.250	6.000	0.375	133	152	10	26086-3067	88	5.250	6.500	0.625	133	165	16
29502-5424	IG	5.250	6.000	0.750	133	152	19	24802-3067	EQUAL	5.250	6.500	0.625	133	165	16
25135-1517	23	5.250	6.234	0.492	133	158	12	29602-4208	GD	5.250	6.500	0.700	133	165	18
25003-5900	23	5.250	6.250	0.437	133	159	11	22987-5171	53F1	5.250	6.500	0.719	133	165	18
25010-3059	23	5.250	6.250	0.500	133	159	13	29502-4208	IG	5.250	6.500	0.750	133	165	19
25138-3059	23	5.250	6.250	0.500	133	159	13	29520-4208	IG	5.250	6.500	0.750	133	165	19
25003-3059	23	5.250	6.250	0.500	133	159	13	22897-6750	53T2	5.250	6.500	0.969	133	165	25
25006-3059	23	5.250	6.250	0.500	133	159	13	25003-4733	23	5.250	6.563	0.750	133	167	19
25004-3059	23	5.250	6.250	0.500	133	159	13	25003-3068	23	5.250	6.625	0.500	133	168	13
24626-3059	26	5.250	6.250	0.500	133	159	13	25003-3071	23	5.250	6.750	0.500	133	171	13
24600-3059	26	5.250	6.250	0.500	133	159	13	25004-3071	23	5.250	6.750	0.500	133	171	13
24610-3059	26	5.250	6.250	0.500	133	159	13	21096-3071	53	5.250	6.750	0.500	133	171	13
21086-3059	53	5.250	6.250	0.500	133	159	13	21086-3071	53	5.250	6.750	0.500	133	171	13

All dimensions are in inches. Preferred sizes are indicated with **bold** type face. Sizes listed are for standard nitrile elements, except Models 25 and 62 which have PTFE elements. Other material available on inquiry only.

## Oil Seals by Model Number

Product Code	Model	Inches			MM			Product Code	Model	Inches			MM		
		ID	OD	Width	ID	OD	Width			ID	OD	Width	ID	OD	Width
21699-3071	53	5.250	6.750	0.500	133	171	13	29519-6987	IG	5.315	6.681	0.625	135	170	16
25003-3073	23	5.250	6.750	0.625	133	171	16	25010-9175	23	5.315	6.693	0.472	135	170	12
22501-3073	53G1	5.250	6.750	0.625	133	171	16	25003-9175	23	5.315	6.693	0.472	135	170	12
24802-3073	EQUAL	5.250	6.750	0.625	133	171	16	25006-9175	23	5.315	6.693	0.472	135	170	12
24822-3073	EQUAL	5.250	6.750	0.625	133	171	16	25003-2572	23	5.315	6.693	0.500	135	170	13
29602-2573	GD	5.250	6.750	0.700	133	171	18	25003-3118	23	5.315	6.693	0.591	135	170	15
25003-6366	23	5.250	6.750	0.750	133	171	19	24802-3162	EQUAL	5.315	6.693	0.625	135	170	16
24627-2573	26	5.250	6.750	0.750	133	171	19	29502-4993	IG	5.315	6.693	0.750	135	170	19
24824-2573	EQUAL	5.250	6.750	0.750	133	171	19	25003-4792	23	5.315	6.825	0.500	135	173	13
22627-7610	53R2	5.250	6.750	0.906	133	171	23	29602-6701	GD	5.370	6.370	0.700	136	162	18
21086-3077	53	5.250	7.000	0.500	133	178	13	24060-1676	61	5.375	6.125	0.500	137	156	13
21086-3080	53	5.250	7.125	0.500	133	181	13	29502-5745	IG	5.375	6.125	0.750	137	156	19
22627-9972	53R2	5.250	7.125	0.906	133	181	23	25003-4576	23	5.375	6.313	0.500	137	160	13
24610-2606	26	5.250	7.323	0.500	133	186	13	25003-6622	23	5.375	6.375	0.375	137	162	10
21140-6020	54	5.250	10.750	0.688	133	273	17	24062-4409	61	5.375	6.375	0.438	137	162	11
25003-5717	23	5.280	6.280	0.500	134	160	13	25003-3122	23	5.375	6.375	0.500	137	162	13
24610-6086	26	5.299	6.299	0.500	135	160	13	25144-3122	23	5.375	6.375	0.500	137	162	13
25003-3090	23	5.302	6.302	0.500	135	160	13	25058-3122	25	5.375	6.375	0.500	137	162	13
25003-2022	23	5.305	6.305	0.500	135	160	13	24620-3122	26R1	5.375	6.375	0.500	137	162	13
25010-7132	23	5.313	6.313	0.500	135	160	13	24626-3122	26	5.375	6.375	0.500	137	162	13
25003-7132	23	5.313	6.313	0.500	135	160	13	24627-3122	26	5.375	6.375	0.500	137	162	13
25006-7132	23	5.313	6.313	0.500	135	160	13	24600-3122	26	5.375	6.375	0.500	137	162	13
25003-3092	23	5.313	6.375	0.500	135	162	13	21096-3122	53	5.375	6.375	0.500	137	162	13
21086-3092	53	5.313	6.375	0.500	135	162	13	21597-3122	53	5.375	6.375	0.500	137	162	13
21699-3092	53	5.313	6.375	0.500	135	162	13	21086-3122	53	5.375	6.375	0.500	137	162	13
29516-7072	IG	5.313	6.375	0.988	135	162	25	21947-3122	53	5.375	6.375	0.500	137	162	13
29616-7072	GD	5.313	6.375	1.297	135	162	33	21409-3122	53	5.375	6.375	0.500	137	162	13
25003-4066	23	5.313	6.500	0.406	135	165	10	21699-3122	53	5.375	6.375	0.500	137	162	13
25003-3095	23	5.313	6.500	0.500	135	165	13	24060-3122	61	5.375	6.375	0.500	137	162	13
21086-3095	53	5.313	6.500	0.500	135	165	13	29502-1864	IG	5.375	6.375	0.750	137	162	19
21699-3095	53	5.313	6.500	0.500	135	165	13	24801-1864	EQUAL	5.375	6.375	0.750	137	162	19
21702-3095	62	5.313	6.500	0.500	135	165	13	25003-3125	23	5.375	6.500	0.500	137	165	13
25003-5092	23	5.313	6.563	0.625	135	167	16	25004-3125	23	5.375	6.500	0.500	137	165	13
25006-5092	23	5.313	6.563	0.625	135	167	16	21086-3125	53	5.375	6.500	0.500	137	165	13
25004-5092	23	5.313	6.563	0.625	135	167	16	21699-3125	53	5.375	6.500	0.500	137	165	13
25003-4786	23	5.313	6.578	0.500	135	167	13	21527-3125	66	5.375	6.500	0.500	137	165	13
25003-3098	23	5.313	6.625	0.500	135	168	13	25003-3126	23	5.375	6.500	0.563	137	165	14
21086-3098	53	5.313	6.625	0.500	135	168	13	25003-3127	23	5.375	6.500	0.625	137	165	16
21086-3101	53	5.313	6.750	0.500	135	171	13	21086-3127	53	5.375	6.500	0.625	137	165	16
25003-5931	23	5.313	6.813	0.500	135	173	13	24063-3127	61	5.375	6.500	0.625	137	165	16
21086-3104	53	5.313	6.875	0.500	135	175	13	25054-3128	23	5.375	6.625	0.500	137	168	13
25003-9251	23	5.313	6.938	0.500	135	176	13	25003-3128	23	5.375	6.625	0.500	137	168	13
29502-6324	IG	5.314	6.299	0.750	135	160	19	21086-3128	53	5.375	6.625	0.500	137	168	13
25003-5355	23	5.314	6.496	0.551	135	165	14	21095-3128	53	5.375	6.625	0.500	137	168	13
24610-9175	26	5.314	6.693	0.512	135	170	13	25003-3129	23	5.375	6.625	0.563	137	168	14
24626-9175	26	5.315	6.693	0.512	135	170	13	21086-3129	53	5.375	6.625	0.563	137	168	14
24600-9175	26	5.315	6.693	0.512	135	170	13	21702-3129	62	5.375	6.625	0.563	137	168	14
24620-3118	26R1	5.315	6.693	0.591	135	170	15	25003-3130	23	5.375	6.625	0.625	137	168	16
24602-3118	26	5.315	6.693	0.591	135	170	15	24627-3129	26	5.375	6.625	0.625	137	168	16
29507-7251	IG	5.315	5.906	0.625	135	150	16	24610-3129	26	5.375	6.625	0.625	137	168	16
25003-5511	23	5.315	6.299	0.500	135	160	13	21086-3130	53	5.375	6.625	0.625	137	168	16
25003-5378	23	5.315	6.456	0.487	135	164	12	21011-4559	111	5.375	6.688	0.563	137	170	14
24060-1884	61	5.315	6.496	0.315	135	165	8	25010-3131	23	5.375	6.750	0.500	137	171	13
24610-6549	26	5.315	6.496	0.551	135	165	14	25003-3131	23	5.375	6.750	0.500	137	171	13
24801-5088	EQUAL	5.315	6.496	0.625	135	165	16	25006-3131	23	5.375	6.750	0.500	137	171	13
24600-2047	26	5.315	6.614	0.709	135	168	18	21096-3131	53	5.375	6.750	0.500	137	171	13

All dimensions are in inches. Preferred sizes are indicated with **bold** type face.

Sizes listed are for standard nitrile elements, except Models 25 and 62 which have PTFE elements. Other material available on inquiry only.



## Oil Seals by Model Number

Product Code	Model	Inches			MM			Product Code	Model	Inches			MM		
		ID	OD	Width	ID	OD	Width			ID	OD	Width	ID	OD	Width
21086-3131	53	5.375	6.750	0.500	137	171	13	21086-3161	53	5.438	7.000	0.500	138	178	13
24600-3124	26	5.375	6.750	0.625	137	171	16	21699-3161	53	5.438	7.000	0.500	138	178	13
25003-3134	23	5.375	6.875	0.500	137	175	13	21086-3167	53	5.438	7.250	0.500	138	184	13
25003-3136	23	5.375	6.875	0.625	137	175	16	25003-3820	23	5.460	6.585	0.375	139	167	10
21086-3136	53	5.375	6.875	0.625	137	175	16	24610-5605	26	5.469	6.469	0.500	139	164	13
24803-6040	EQUAL	5.375	6.875	0.625	137	175	16	29502-6712	IG	5.495	6.495	0.750	140	165	19
25003-7124	23	5.375	6.875	0.750	137	175	19	24060-3055	61	5.500	6.125	0.500	140	156	13
21086-3139	53	5.375	7.000	0.625	137	178	16	24060-1679	61	5.500	6.250	0.437	140	159	11
21699-3139	53	5.375	7.000	0.625	137	178	16	24600-3177	26	5.500	6.250	0.438	140	159	11
21086-3142	53	5.375	7.125	0.625	137	181	16	25003-2624	23	5.500	6.375	0.437	140	162	11
25001-3151	21	5.375	7.500	0.625	137	191	16	25003-1682	23	5.500	6.375	0.500	140	162	13
25002-3151	21	5.375	7.500	0.625	137	191	16	25006-1682	23	5.500	6.375	0.500	140	162	13
21086-3151	53	5.375	7.500	0.625	137	191	16	24060-1682	61	5.500	6.375	0.500	140	162	13
25003-4841	23	5.420	6.625	0.500	138	168	13	24600-3019	26	5.500	6.375	0.563	140	162	14
24824-3421	EQUAL	5.433	6.437	0.625	138	163	16	21332-2413	143	5.500	6.450	0.810	140	164	21
24600-4226	26	5.433	7.008	0.630	138	178	16	24060-1683	61	5.500	6.500	0.250	140	165	6
25003-0627	23	5.437	6.375	0.500	138	162	13	21825-2989	111	5.500	6.500	0.438	140	165	11
25004-4750	23	5.437	6.437	0.500	138	163	13	25010-3176	23	5.500	6.500	0.500	140	165	13
25003-0738	23	5.437	6.500	0.500	138	165	13	25003-3176	23	5.500	6.500	0.500	140	165	13
21086-3152	53	5.437	6.625	0.500	138	168	13	25006-3176	23	5.500	6.500	0.500	140	165	13
21699-3152	53	5.437	6.625	0.500	138	168	13	25004-3176	23	5.500	6.500	0.500	140	165	13
25010-6367	23	5.437	6.687	0.625	138	170	16	25284-3176	23	5.500	6.500	0.500	140	165	13
25003-3155	23	5.437	6.750	0.500	138	171	13	24627-3176	26	5.500	6.500	0.500	140	165	13
21699-3155	53	5.437	6.750	0.500	138	171	13	24600-3176	26	5.500	6.500	0.500	140	165	13
22987-5027	53F1	5.437	6.875	0.969	138	175	25	24610-3176	26	5.500	6.500	0.500	140	165	13
25009-4750	23	5.438	6.437	0.500	138	163	13	24602-3176	26	5.500	6.500	0.500	140	165	13
24610-0669	26	5.438	6.437	0.500	138	163	13	24626-3176	26	5.500	6.500	0.500	140	165	13
25010-4750	23	5.438	6.438	0.500	138	164	13	21096-3176	53	5.500	6.500	0.500	140	165	13
25003-4750	23	5.438	6.438	0.500	138	164	13	21087-3176	53	5.500	6.500	0.500	140	165	13
25006-4750	23	5.438	6.438	0.500	138	164	13	21091-3176	53	5.500	6.500	0.500	140	165	13
25284-4750	23	5.438	6.438	0.500	138	164	13	21086-3176	53	5.500	6.500	0.500	140	165	13
24610-4750	26	5.438	6.438	0.500	138	164	13	21699-3176	53	5.500	6.500	0.500	140	165	13
29502-4304	IG	5.438	6.438	0.750	138	164	19	21003-3176	58	5.500	6.500	0.500	140	165	13
25010-3152	23	5.438	6.625	0.500	138	168	13	24064-3176	61	5.500	6.500	0.500	140	165	13
25003-3152	23	5.438	6.625	0.500	138	168	13	21702-3176	62	5.500	6.500	0.500	140	165	13
24600-3173	26	5.438	6.625	0.500	138	168	13	22500-3178	53G1	5.500	6.500	0.625	140	165	16
21086-3152	53	5.438	6.625	0.500	138	168	13	21086-3178	53	5.500	6.500	0.625	140	165	16
29602-6787	GD	5.438	6.625	0.700	138	168	18	29519-3178	IG	5.500	6.500	0.625	140	165	16
25003-6532	23	5.438	6.656	0.463	138	169	12	24801-3178	EQUAL	5.500	6.500	0.625	140	165	16
25054-6367	23	5.438	6.688	0.625	138	170	16	24820-3178	EQUAL	5.500	6.500	0.625	140	165	16
25003-6367	23	5.438	6.688	0.625	138	170	16	24822-3178	EQUAL	5.500	6.500	0.625	140	165	16
25006-6367	23	5.438	6.688	0.625	138	170	16	22987-6741	53F1	5.500	6.500	0.719	140	165	18
24802-2904	EQUAL	5.438	6.688	0.625	138	170	16	29502-4172	IG	5.500	6.500	0.750	140	165	19
25003-1250	23	5.438	6.720	0.625	138	171	16	22537-4825	53R1	5.500	6.500	0.906	140	165	23
21096-3155	53	5.438	6.750	0.500	138	171	13	25003-0743	23	5.500	6.563	0.500	140	167	13
21086-3155	53	5.438	6.750	0.500	138	171	13	25003-3212	23	5.500	6.625	0.406	140	168	10
25003-3157	23	5.438	6.750	0.625	138	171	16	25003-3179	23	5.500	6.625	0.500	140	168	13
25003-1777	23	5.438	6.750	0.750	138	171	19	21086-3179	53	5.500	6.625	0.500	140	168	13
29516-7103	IG	5.438	6.750	0.983	138	171	25	21557-3179	53	5.500	6.625	0.500	140	168	13
24816-7049	EQUAL	5.438	6.750	1.250	138	171	32	21699-3179	53	5.500	6.625	0.500	140	168	13
29616-7103	GD	5.438	6.750	1.308	138	171	33	25003-3180	23	5.500	6.625	0.563	140	168	14
21086-3158	53	5.438	6.875	0.500	138	175	13	22500-3181	53G1	5.500	6.625	0.625	140	168	16
25003-3144	23	5.438	6.875	0.750	138	175	19	24620-3186	26R1	5.500	6.632	0.500	140	168	13
29500-4504	IG	5.438	6.875	0.750	138	175	19	29502-5279	IG	5.500	6.693	0.750	140	170	19
25003-8575	23	5.438	6.938	0.625	138	176	16	25003-3182	23	5.500	6.750	0.500	140	171	13
25058-8782	25	5.438	6.938	0.750	138	176	19	25006-3182	23	5.500	6.750	0.500	140	171	13

All dimensions are in inches. Preferred sizes are indicated with **bold** type face. Sizes listed are for standard nitrile elements, except Models 25 and 62 which have PTFE elements. Other material available on inquiry only.

## Oil Seals by Model Number

Product Code	Model	Inches			MM			Product Code	Model	Inches			MM		
		ID	OD	Width	ID	OD	Width			ID	OD	Width	ID	OD	Width
24600-3182	26	5.500	6.750	0.500	140	171	13	21699-3200	53	5.500	7.500	0.500	140	191	13
24610-3182	26	5.500	6.750	0.500	140	171	13	27223-8960	94	5.500	8.268	0.500	140	210	13
21086-3182	53	5.500	6.750	0.500	140	171	13	29502-4735	1G	5.500	10.250	0.750	140	260	19
21699-3182	53	5.500	6.750	0.500	140	171	13	29519-6518	1G	5.506	6.506	0.625	140	165	16
24700-3182	59	5.500	6.750	0.500	140	171	13	29519-6880	1G	5.510	6.500	0.625	140	165	16
24600-3183	26	5.500	6.750	0.563	140	171	14	25003-4831	23	5.511	6.511	0.500	140	165	13
25003-2409	23	5.500	6.750	0.575	140	171	15	25003-5861	23	5.511	6.692	0.625	140	170	16
25045-3184	23	5.500	6.750	0.625	140	171	16	25003-1718	23	5.511	6.693	0.472	140	170	12
25003-3184	23	5.500	6.750	0.625	140	171	16	25003-5368	23	5.511	6.811	0.547	140	173	14
25004-3184	23	5.500	6.750	0.625	140	171	16	24610-3201	26	5.512	6.299	0.512	140	160	13
24602-3184	26	5.500	6.750	0.625	140	171	16	24060-1898	61	5.512	6.496	0.394	140	165	10
24626-3184	26	5.500	6.750	0.625	140	171	16	24602-2036	26	5.512	6.693	0.472	140	170	12
24600-3184	26	5.500	6.750	0.625	140	171	16	24627-7383	26	5.512	6.693	0.551	140	170	14
21096-3184	53	5.500	6.750	0.625	140	171	16	24626-7267	26	5.512	6.693	0.591	140	170	15
21086-3184	53	5.500	6.750	0.625	140	171	16	24600-7267	26	5.512	6.693	0.591	140	170	15
21947-3184	53	5.500	6.750	0.625	140	171	16	24610-7267	26	5.512	6.693	0.591	140	170	15
21699-3184	53	5.500	6.750	0.625	140	171	16	24602-7267	26	5.512	6.693	0.591	140	170	15
21702-3184	62	5.500	6.750	0.625	140	171	16	21096-7267	53	5.512	6.693	0.591	140	170	15
24801-3184	EQUAL	5.500	6.750	0.625	140	171	16	26058-7267	57	5.512	6.693	0.591	140	170	15
24802-3184	EQUAL	5.500	6.750	0.625	140	171	16	25010-3733	23	5.512	6.772	0.591	140	172	15
24822-3184	EQUAL	5.500	6.750	0.625	140	171	16	24600-3204	26	5.512	6.890	0.709	140	175	18
25003-2159	23	5.500	6.750	0.687	140	171	17	24627-1963	26	5.512	7.087	0.591	140	180	15
29602-6574	GD	5.500	6.750	0.700	140	171	18	24823-5267	EQUAL	5.512	6.000	0.690	140	152	18
25003-6574	23	5.500	6.750	0.750	140	171	19	24620-3201	26R1	5.512	6.299	0.512	140	160	13
25006-6574	23	5.500	6.750	0.750	140	171	19	24637-3206	26	5.512	6.378	0.472	140	162	12
29502-6574	1G	5.500	6.750	0.750	140	171	19	25003-4489	23	5.512	6.387	0.375	140	162	10
29520-6574	EQUAL	5.500	6.750	0.750	140	171	19	25003-2019	23	5.512	6.496	0.492	140	165	12
22627-7409	53R2	5.500	6.750	0.906	140	171	23	24801-5140	EQUAL	5.512	6.496	0.625	140	165	16
29516-7150	1G	5.500	6.750	1.062	140	171	27	24822-3728	EQUAL	5.512	6.512	0.625	140	165	16
25003-4461	23	5.500	6.756	0.500	140	172	13	29500-6710	1G	5.512	6.654	0.750	140	169	19
25003-6540	23	5.500	6.765	0.500	140	172	13	25003-9158	23	5.512	6.692	0.500	140	170	13
25003-3185	23	5.500	6.875	0.500	140	175	13	25006-9158	23	5.512	6.692	0.500	140	170	13
21096-3185	53	5.500	6.875	0.500	140	175	13	24600-3203	26	5.512	6.693	0.295	140	170	7
21086-3185	53	5.500	6.875	0.500	140	175	13	25006-1718	23	5.512	6.693	0.472	140	170	12
25003-1961	23	5.500	6.875	0.563	140	175	14	24648-7383	26	5.512	6.693	0.511	140	170	13
24840-3537	EQUAL	5.500	6.875	0.750	140	175	19	24638-3205	26	5.512	6.693	0.512	140	170	13
25003-3188	23	5.500	7.000	0.500	140	178	13	25003-7383	23	5.512	6.693	0.551	140	170	14
24620-0963	26R1	5.500	7.000	0.500	140	178	13	24629-7383	26R1	5.512	6.693	0.551	140	170	14
21699-3188	53	5.500	7.000	0.500	140	178	13	24620-7383	26R1	5.512	6.693	0.551	140	170	14
21096-3188	53	5.500	7.000	0.500	140	178	13	21087-7383	53	5.512	6.693	0.551	140	170	14
21086-3188	53	5.500	7.000	0.500	140	178	13	21086-7383	53	5.512	6.693	0.551	140	170	14
25003-3190	23	5.500	7.000	0.625	140	178	16	21947-7383	53	5.512	6.693	0.551	140	170	14
21086-3190	53	5.500	7.000	0.625	140	178	16	21409-7383	53	5.512	6.693	0.551	140	170	14
25003-5010	23	5.500	7.000	0.750	140	178	19	21699-7383	53	5.512	6.693	0.551	140	170	14
24620-5010	26R1	5.500	7.000	0.750	140	178	19	24060-7383	61	5.512	6.693	0.552	140	170	14
24600-3189	26	5.500	7.000	0.750	140	178	19	25003-7267	23	5.512	6.693	0.591	140	170	15
24620-3193	26R1	5.500	7.000	0.828	140	178	21	25010-7267	23	5.512	6.693	0.591	140	170	15
22897-5923	53T2	5.500	7.000	0.969	140	178	25	25006-7267	23	5.512	6.693	0.591	140	170	15
21086-3191	53	5.500	7.125	0.500	140	181	13	24612-7267	26	5.512	6.693	0.591	140	170	15
29502-6154	1G	5.500	7.125	0.750	140	181	19	21086-7267	53	5.512	6.693	0.591	140	170	15
25003-3433	23	5.500	7.193	0.625	140	183	16	21699-7267	53	5.512	6.693	0.591	140	170	15
24600-3194	26	5.500	7.250	0.500	140	184	13	26063-7267	57	5.512	6.693	0.591	140	170	15
21086-3194	53	5.500	7.250	0.500	140	184	13	26056-7267	57	5.512	6.693	0.591	140	170	15
21096-3200	53	5.500	7.500	0.500	140	191	13	26057-7267	57	5.512	6.693	0.591	140	170	15
21088-3200	53	5.500	7.500	0.500	140	191	13	24780-7267	59	5.512	6.693	0.591	140	170	15
21086-3200	53	5.500	7.500	0.500	140	191	13	29619-2116	GD	5.512	6.693	0.625	140	170	16

All dimensions are in inches. Preferred sizes are indicated with **bold** type face.

Sizes listed are for standard nitrile elements, except Models 25 and 62 which have PTFE elements. Other material available on inquiry only.

## Oil Seals by Model Number

Product Code	Model	Inches			MM			Product Code	Model	Inches			MM		
		ID	OD	Width	ID	OD	Width			ID	OD	Width	ID	OD	Width
24700-1134	59	5.512	6.693	0.630	140	170	16	21482-3234	66	5.625	6.875	0.500	143	175	13
29500-4994	1G	5.512	6.693	0.750	140	170	19	21086-3235	53	5.625	6.875	0.563	143	175	14
29502-4994	1G	5.512	6.693	0.750	140	170	19	25003-3236	23	5.625	6.875	0.625	143	175	16
25003-3204	23	5.512	6.890	0.709	140	175	18	25006-3236	23	5.625	6.875	0.625	143	175	16
24610-1963	26	5.512	7.087	0.590	140	180	15	24600-3236	26	5.625	6.875	0.625	143	175	16
24060-2461	61	5.512	7.087	0.591	140	180	15	21086-3236	53	5.625	6.875	0.625	143	175	16
25003-3148	23	5.512	7.087	0.625	140	180	16	24802-3236	EQUAL	5.625	6.875	0.625	143	175	16
25006-3148	23	5.512	7.087	0.625	140	180	16	24822-3236	EQUAL	5.625	6.875	0.625	143	175	16
24626-2098	26	5.512	7.087	0.630	140	180	16	29602-4830	GD	5.625	6.875	0.700	143	175	18
24600-2098	26	5.512	7.087	0.630	140	180	16	22987-8471	53F1	5.625	6.875	0.719	143	175	18
24612-2098	26	5.512	7.087	0.630	140	180	16	29500-4830	1G	5.625	6.875	0.750	143	175	19
29516-7186	1G	5.512	8.366	0.804	140	212	20	22627-5324	53R2	5.625	6.875	0.969	143	175	25
25003-0674	23	5.515	6.497	0.500	140	165	13	21086-3237	53	5.625	7.000	0.500	143	178	13
25003-0500	23	5.523	6.500	0.500	140	165	13	21699-3237	53	5.625	7.000	0.500	143	178	13
25003-0589	23	5.525	6.500	0.500	140	165	13	25003-4762	23	5.625	7.000	0.750	143	178	19
25003-9760	23	5.563	6.563	0.500	141	167	13	24627-6333	26	5.625	7.125	0.375	143	181	10
25003-3203	23	5.563	6.625	0.500	141	168	13	25003-3240	23	5.625	7.125	0.500	143	181	13
21086-3203	53	5.563	6.625	0.500	141	168	13	25005-3240	24	5.625	7.125	0.500	143	181	13
25003-6150	23	5.563	6.750	0.500	141	171	13	21086-3240	53	5.625	7.125	0.500	143	181	13
21086-3208	53	5.563	6.750	0.625	141	171	16	21699-3240	53	5.625	7.125	0.500	143	181	13
21086-3218	53	5.563	7.250	0.500	141	184	13	29602-6482	GD	5.625	7.125	0.700	143	181	18
21086-3226	53	5.563	7.500	0.625	141	191	16	25003-6368	23	5.625	7.125	0.750	143	181	19
29502-5549	1G	5.591	6.378	0.750	142	162	19	21086-3243	53	5.625	7.250	0.500	143	184	13
29602-6992	GD	5.620	6.620	0.700	143	168	18	21086-3245	53	5.625	7.250	0.625	143	184	16
24620-3232	26R1	5.625	6.625	0.375	143	168	10	21086-3246	53	5.625	7.375	0.500	143	187	13
25003-3228	23	5.625	6.625	0.500	143	168	13	21086-3249	53	5.625	7.500	0.500	143	191	13
25006-3228	23	5.625	6.625	0.500	143	168	13	22987-7002	53F1	5.625	7.500	0.719	143	191	18
25004-3228	23	5.625	6.625	0.500	143	168	13	25001-3535	21	5.625	7.875	0.500	143	200	13
21086-3228	53	5.625	6.625	0.500	143	168	13	25001-3441	21	5.625	8.125	0.750	143	206	19
21087-3228	53	5.625	6.625	0.500	143	168	13	21140-6021	54	5.625	11.375	1.000	143	289	25
21086-3228	53	5.625	6.625	0.500	143	168	13	29502-5774	1G	5.635	6.874	0.750	143	175	19
21806-3228	53	5.625	6.625	0.500	143	168	13	29619-7224	GD	5.667	6.667	0.625	144	169	16
21699-3228	53	5.625	6.625	0.500	143	168	13	29602-7224	GD	5.667	6.667	0.700	144	169	18
22501-3230	53G1	5.625	6.625	0.625	143	168	16	25003-7362	23	5.687	6.937	0.500	144	176	13
21086-3230	53	5.625	6.625	0.625	143	168	16	25284-9663	23	5.687	7.187	0.500	144	183	13
29519-6529	1G	5.625	6.625	0.625	143	168	16	25003-9663	23	5.687	7.187	0.500	144	183	13
24801-1177	EQUAL	5.625	6.625	0.625	143	168	16	25009-9663	23	5.687	7.187	0.500	144	183	13
24821-1177	EQUAL	5.625	6.625	0.625	143	168	16	22627-5090	53R2	5.687	7.500	0.906	144	191	23
24822-1177	EQUAL	5.625	6.625	0.625	143	168	16	24822-2774	EQUAL	5.688	6.688	0.625	144	170	16
29602-4173	GD	5.625	6.625	0.700	143	168	18	29502-4306	1G	5.688	6.688	0.750	144	170	19
29500-4173	1G	5.625	6.625	0.750	143	168	19	25003-3253	23	5.688	6.750	0.500	144	171	13
29502-4173	1G	5.625	6.625	0.750	143	168	19	21086-3253	53	5.688	6.750	0.500	144	171	13
29522-4173	1G	5.625	6.625	0.750	143	168	19	25003-3258	23	5.688	6.750	0.625	144	171	16
25003-3231	23	5.625	6.750	0.500	143	171	13	21086-3258	53	5.688	6.875	0.625	144	175	16
21087-3231	53	5.625	6.750	0.500	143	171	13	25003-9914	23	5.688	6.938	0.625	144	176	16
21086-3231	53	5.625	6.750	0.500	143	171	13	21086-3259	53	5.688	7.000	0.500	144	178	13
21699-3231	53	5.625	6.750	0.500	143	171	13	25003-7444	23	5.688	7.000	0.625	144	178	16
25003-3233	23	5.625	6.750	0.625	143	171	16	25005-9663	24	5.688	7.188	0.500	144	183	13
22500-3233	53G1	5.625	6.750	0.625	143	171	16	21086-3268	53	5.688	7.375	0.500	144	187	13
22537-4711	53R1	5.625	6.750	0.906	143	171	23	21086-3270	53	5.688	7.375	0.625	144	187	16
24060-2296	61	5.625	6.875	0.219	143	175	6	21086-3271	53	5.688	7.500	0.500	144	191	13
24060-2316	61	5.625	6.875	0.281	143	175	7	24822-5696	EQUAL	5.704	7.204	0.625	145	183	16
25003-3234	23	5.625	6.875	0.500	143	175	13	24821-6067	EQUAL	5.704	7.204	0.750	145	183	19
21086-3234	53	5.625	6.875	0.500	143	175	13	24802-5780	EQUAL	5.704	7.210	0.625	145	183	16
21086-3234	53	5.625	6.875	0.500	143	175	13	25003-5349	23	5.708	6.889	0.551	145	175	14
21699-3234	53	5.625	6.875	0.500	143	175	13	25006-5349	23	5.708	6.889	0.551	145	175	14

All dimensions are in inches. Preferred sizes are indicated with **bold** type face. Sizes listed are for standard nitrile elements, except Models 25 and 62 which have PTFE elements. Other material available on inquiry only.

## Oil Seals by Model Number

Product Code	Model	Inches			MM			Product Code	Model	Inches			MM		
		ID	OD	Width	ID	OD	Width			ID	OD	Width	ID	OD	Width
24629-5349	26R1	5.708	6.889	0.551	145	175	14	24600-3287	26	5.750	6.950	0.305	146	177	8
25003-3197	23	5.708	7.086	0.630	145	180	16	25003-6474	23	5.750	6.968	0.500	146	177	13
24608-5347	26R1	5.709	6.890	0.551	145	175	14	25003-6924	23	5.750	7.000	0.375	146	178	10
24620-5349	26R1	5.709	6.890	0.551	145	175	14	25010-3281	23	5.750	7.000	0.500	146	178	13
26058-0958	57	5.709	6.890	0.591	145	175	15	25003-3281	23	5.750	7.000	0.500	146	178	13
24716-4040	59	5.709	7.087	0.591	145	180	15	25006-3281	23	5.750	7.000	0.500	146	178	13
25003-3808	23	5.709	6.693	0.394	145	170	10	24610-3281	26	5.750	7.000	0.500	146	178	13
26057-0958	57	5.709	6.890	0.591	145	175	15	24600-3281	26	5.750	7.000	0.500	146	178	13
29519-6865	IG	5.709	6.890	0.625	145	175	16	21086-3281	53	5.750	7.000	0.500	146	178	13
25003-4415	23	5.709	7.087	0.591	145	180	15	21699-3281	53	5.750	7.000	0.500	146	178	13
25006-4415	23	5.709	7.087	0.591	145	180	15	24715-3281	59	5.750	7.000	0.500	146	178	13
24821-6270	EQUAL	5.711	7.000	0.625	145	178	16	24700-3281	59	5.750	7.000	0.500	146	178	13
25003-0519	23	5.748	7.087	0.591	146	180	15	25003-3282	23	5.750	7.000	0.563	146	178	14
24060-1685	61	5.750	6.500	0.500	146	165	13	25006-3282	23	5.750	7.000	0.563	146	178	14
25003-5726	23	5.750	6.625	0.453	146	168	12	21086-3282	53	5.750	7.000	0.563	146	178	14
25003-3276	23	5.750	6.750	0.438	146	171	11	21702-3282	62	5.750	7.000	0.563	146	178	14
25003-7172	23	5.750	6.750	0.438	146	171	11	25003-3283	23	5.750	7.000	0.625	146	178	16
24602-3276	26	5.750	6.750	0.438	146	171	11	25006-3283	23	5.750	7.000	0.625	146	178	16
25010-3275	23	5.750	6.750	0.500	146	171	13	24600-3283	26	5.750	7.000	0.625	146	178	16
25003-3275	23	5.750	6.750	0.500	146	171	13	24610-3283	26	5.750	7.000	0.625	146	178	16
25006-3275	23	5.750	6.750	0.500	146	171	13	21096-3283	53	5.750	7.000	0.625	146	178	16
25009-3275	23	5.750	6.750	0.500	146	171	13	21086-3283	53	5.750	7.000	0.625	146	178	16
24626-0672	26	5.750	6.750	0.500	146	171	13	22627-9854	53R2	5.750	7.000	0.844	146	178	21
24600-0672	26	5.750	6.750	0.500	146	171	13	22544-6166	53R1	5.750	7.000	0.906	146	178	23
21096-3275	53	5.750	6.750	0.500	146	171	13	22897-7128	53T2	5.750	7.000	0.969	146	178	25
21087-3275	53	5.750	6.750	0.500	146	171	13	25003-3284	23	5.750	7.125	0.500	146	181	13
21086-3275	53	5.750	6.750	0.500	146	171	13	21086-3284	53	5.750	7.125	0.500	146	181	13
21683-3275	53	5.750	6.750	0.500	146	171	13	21702-0752	62	5.750	7.125	0.563	146	181	14
21947-3275	53	5.750	6.750	0.500	146	171	13	25003-9440	23	5.750	7.202	0.734	146	183	19
21699-3275	53	5.750	6.750	0.500	146	171	13	25003-3287	23	5.750	7.250	0.500	146	184	13
24060-3275	61	5.750	6.750	0.500	146	171	13	25005-3287	24	5.750	7.250	0.500	146	184	13
21527-3275	66	5.750	6.750	0.500	146	171	13	21086-3287	53	5.750	7.250	0.500	146	184	13
21597-3276	53	5.750	6.750	0.563	146	171	14	21086-3289	53	5.750	7.250	0.625	146	184	16
21086-3276	53	5.750	6.750	0.563	146	171	14	21699-3289	53	5.750	7.250	0.625	146	184	16
21699-3276	53	5.750	6.750	0.563	146	171	14	25003-9017	23	5.750	7.250	0.750	146	184	19
24627-3277	26	5.750	6.750	0.625	146	171	16	22537-5420	53R1	5.750	7.250	0.906	146	184	23
24600-3277	26	5.750	6.750	0.625	146	171	16	22627-9422	53R2	5.750	7.250	1.031	146	184	26
22502-3277	53G1	5.750	6.750	0.625	146	171	16	21086-3290	53	5.750	7.375	0.500	146	187	13
21702-3277	62	5.750	6.750	0.625	146	171	16	25003-3293	23	5.750	7.500	0.500	146	191	13
24802-3277	EQUAL	5.750	6.750	0.625	146	171	16	21086-3293	53	5.750	7.500	0.500	146	191	13
24822-3277	EQUAL	5.750	6.750	0.625	146	171	16	25001-3288	21	5.750	7.500	0.563	146	191	14
24843-3277	EQUAL	5.750	6.750	0.625	146	171	16	25003-3288	23	5.750	7.500	0.563	146	191	14
29500-4174	IG	5.750	6.750	0.750	146	171	19	25003-5636	23	5.780	7.030	0.625	147	179	16
29502-4174	IG	5.750	6.750	0.750	146	171	19	25003-7507	23	5.800	6.800	0.500	147	173	13
29522-4174	IG	5.750	6.750	0.750	146	171	19	21086-3309	53	5.812	7.375	0.500	148	187	13
22627-3052	53R2	5.750	6.750	0.906	146	171	23	21086-3312	53	5.812	7.500	0.500	148	191	13
25003-3278	23	5.750	6.875	0.500	146	175	13	25003-9197	23	5.813	6.813	0.500	148	173	13
21086-3278	53	5.750	6.875	0.500	146	175	13	25006-9197	23	5.813	6.813	0.500	148	173	13
24715-0967	59	5.750	6.875	0.500	146	175	13	25004-9197	23	5.813	6.813	0.500	148	173	13
21702-3278	62	5.750	6.875	0.500	146	175	13	21086-3297	53	5.813	6.875	0.500	148	175	13
21527-3278	66	5.750	6.875	0.500	146	175	13	25003-7275	23	5.813	6.938	0.500	148	176	13
25003-3279	23	5.750	6.875	0.562	146	175	14	21086-3300	53	5.813	7.000	0.500	148	178	13
25003-3280	23	5.750	6.875	0.625	146	175	16	21086-3305	53	5.813	7.125	0.500	148	181	13
25003-6728	23	5.750	6.938	0.500	146	176	13	29602-6813	GD	5.827	6.693	0.700	148	170	18
29516-7126	IG	5.750	6.938	1.116	146	176	28	25003-2960	23	5.875	6.750	0.500	149	171	13
24816-7055	EQUAL	5.750	6.938	1.250	146	176	32	25003-3303	23	5.875	6.750	0.625	149	171	16

All dimensions are in inches. Preferred sizes are indicated with **bold** type face.

Sizes listed are for standard nitrile elements, except Models 25 and 62 which have PTFE elements. Other material available on inquiry only.

## Oil Seals by Model Number

Product Code	Model	Inches			MM			Product Code	Model	Inches			MM		
		ID	OD	Width	ID	OD	Width			ID	OD	Width	ID	OD	Width
25003-2958	23	5.875	6.812	0.500	149	173	13	24650-5335	26NS	5.906	7.087	0.551	150	180	14
25003-6164	23	5.875	6.875	0.438	149	175	11	24626-5335	26	5.906	7.087	0.551	150	180	14
25003-3316	23	5.875	6.875	0.500	149	175	13	24600-5335	26	5.906	7.087	0.551	150	180	14
25006-3316	23	5.875	6.875	0.500	149	175	13	26058-5335	57	5.906	7.087	0.551	150	180	14
25004-3316	23	5.875	6.875	0.500	149	175	13	26057-5335	57	5.906	7.087	0.551	150	180	14
24626-0674	26	5.875	6.875	0.500	149	175	13	24715-5335	59	5.906	7.087	0.551	150	180	14
24600-0674	26	5.875	6.875	0.500	149	175	13	24602-3327	26	5.906	7.087	0.591	150	180	15
21096-3316	53	5.875	6.875	0.500	149	175	13	24804-1349	EQUAL	5.906	7.087	0.625	150	180	16
21087-3316	53	5.875	6.875	0.500	149	175	13	25003-2341	23	5.906	7.087	0.630	150	180	16
21086-3316	53	5.875	6.875	0.500	149	175	13	24602-3346	26	5.906	7.087	0.630	150	180	16
21095-3316	53	5.875	6.875	0.500	149	175	13	24600-4395	26	5.906	7.480	0.591	150	190	15
21699-3316	53	5.875	6.875	0.500	149	175	13	25010-9751	23	5.906	6.906	0.500	150	175	13
29519-2777	IG	5.875	6.875	0.625	149	175	16	29500-4831	IG	5.906	6.906	0.750	150	175	19
22627-4345	53R2	5.875	6.875	0.969	149	175	25	29502-4831	IG	5.906	6.906	0.750	150	175	19
29516-7125	IG	5.875	6.938	1.116	149	176	28	29504-4831	IG	5.906	6.906	0.750	150	175	19
24816-7118	EQUAL	5.875	6.938	1.523	149	176	39	25003-5335	23	5.906	7.086	0.551	150	180	14
25010-3319	23	5.875	7.000	0.500	149	178	13	24700-5335	59	5.906	7.086	0.551	150	180	14
25003-3319	23	5.875	7.000	0.500	149	178	13	24702-5335	59	5.906	7.086	0.551	150	180	14
25006-3319	23	5.875	7.000	0.500	149	178	13	25003-1111	23	5.906	7.087	0.512	150	180	13
21020-3319	50	5.875	7.000	0.500	149	178	13	24638-3310	26	5.906	7.087	.512	150	180	13
21096-3319	53	5.875	7.000	0.500	149	178	13	24620-5335	26R1	5.906	7.087	0.551	150	180	14
21597-3319	53	5.875	7.000	0.500	149	178	13	24629-5335	26R1	5.906	7.087	0.552	150	180	14
21086-3319	53	5.875	7.000	0.500	149	178	13	25010-3327	23	5.906	7.087	0.591	150	180	15
21699-3319	53	5.875	7.000	0.500	149	178	13	25003-3327	23	5.906	7.087	0.591	150	180	15
21527-3319	66	5.875	7.000	0.500	149	178	13	25006-3327	23	5.906	7.087	0.591	150	180	15
25003-9880	23	5.875	7.125	0.455	149	181	12	24637-3327	26	5.906	7.087	.591	150	180	15
21096-3322	53	5.875	7.125	0.500	149	181	13	24638-3327	26	5.906	7.087	.591	150	180	15
21086-3322	53	5.875	7.125	0.500	149	181	13	24610-3327	26	5.906	7.087	0.591	150	180	15
21699-3322	53	5.875	7.125	0.500	149	181	13	21003-3327	58	5.906	7.087	0.591	150	180	15
25003-3324	23	5.875	7.125	0.625	149	181	16	24801-1349	EQUAL	5.906	7.087	0.625	150	180	16
21086-3324	53	5.875	7.125	0.625	149	181	16	24802-1349	EQUAL	5.906	7.087	0.625	150	180	16
24822-3324	EQUAL	5.875	7.125	0.625	149	181	16	29500-4996	IG	5.906	7.087	0.750	150	180	19
29502-4211	IG	5.875	7.125	0.750	149	181	19	29502-4996	IG	5.906	7.087	0.750	150	180	19
25003-5597	23	5.875	7.140	0.563	149	181	14	25003-4862	23	5.906	7.283	0.708	150	185	18
25006-5597	23	5.875	7.140	0.563	149	181	14	25087-4862	23	5.906	7.283	0.708	150	185	18
25003-3325	23	5.875	7.250	0.500	149	184	13	25010-7117	23	5.906	7.410	0.625	150	188	16
21086-3325	53	5.875	7.250	0.500	149	184	13	25003-7117	23	5.906	7.410	0.625	150	188	16
22537-8480	53R1	5.875	7.250	0.906	149	184	23	25003-4043	23	5.906	7.480	0.551	150	190	14
25003-3328	23	5.875	7.375	0.500	149	187	13	25003-2233	23	5.906	7.480	0.591	150	190	15
21086-3328	53	5.875	7.375	0.500	149	187	13	24610-2933	26	5.906	7.480	0.630	150	190	16
25003-3330	23	5.875	7.375	0.625	149	187	16	25003-1374	23	5.906	7.906	0.500	150	201	13
24600-3330	26	5.875	7.375	0.625	149	187	16	24600-1259	26	5.935	6.963	0.516	151	177	13
25003-9142	23	5.875	7.375	0.750	149	187	19	25003-0741	23	5.938	6.875	0.500	151	175	13
25006-3331	23	5.875	7.500	0.500	149	191	13	25003-7298	23	5.938	6.938	0.500	151	176	13
21086-3331	53	5.875	7.500	0.500	149	191	13	25006-7298	23	5.938	6.938	0.500	151	176	13
21699-3331	53	5.875	7.500	0.500	149	191	13	25284-7298	23	5.938	6.938	0.500	151	176	13
21003-3331	58	5.875	7.500	0.500	149	191	13	29502-4308	IG	5.938	6.938	0.750	151	176	19
25003-3332	23	5.875	7.500	0.563	149	191	14	25010-3335	23	5.938	7.000	0.500	151	178	13
25053-3334	21	5.875	7.500	0.750	149	191	19	25003-3335	23	5.938	7.000	0.500	151	178	13
25001-3334	21	5.875	7.500	0.750	149	191	19	25006-3335	23	5.938	7.000	0.500	151	178	13
24626-6607	26	5.886	7.087	0.512	150	180	13	25009-3335	23	5.938	7.000	0.500	151	178	13
25003-3171	23	5.897	7.147	0.625	150	182	16	21096-3335	53	5.938	7.000	0.500	151	178	13
29525-5948	IG	5.900	6.900	0.750	150	175	19	21597-3335	53	5.938	7.000	0.500	151	178	13
24610-5335	26	5.905	7.086	0.590	150	180	15	21086-3335	53	5.938	7.000	0.500	151	178	13
25010-1111	23	5.905	7.087	0.512	150	180	13	25003-3338	23	5.938	7.125	0.500	151	181	13
25005-9952	24	5.905	7.405	0.500	150	188	13	21086-3338	53	5.938	7.125	0.500	151	181	13

All dimensions are in inches. Preferred sizes are indicated with **bold** type face.  
 Sizes listed are for standard nitrile elements, except Models 25 and 62 which have PTFE elements. Other material available on inquiry only.

## Oil Seals by Model Number

Product Code	Model	Inches			MM			Product Code	Model	Inches			MM		
		ID	OD	Width	ID	OD	Width			ID	OD	Width	ID	OD	Width
25006-7647	23	5.938	7.187	0.500	151	183	13	25003-3357	23	6.000	7.000	0.625	152	178	16
25003-7647	23	5.938	7.188	0.500	151	183	13	21086-3357	53	6.000	7.000	0.625	152	178	16
25003-7481	23	5.938	7.188	0.625	151	183	16	21699-3357	53	6.000	7.000	0.625	152	178	16
25003-3343	23	5.938	7.250	0.625	151	184	16	29619-3357	GD	6.000	7.000	0.625	152	178	16
21597-3343	53	5.938	7.250	0.625	151	184	16	24801-3357	EQUAL	6.000	7.000	0.625	152	178	16
21088-3343	53	5.938	7.250	0.625	151	184	16	24802-3357	EQUAL	6.000	7.000	0.625	152	178	16
21086-3343	53	5.938	7.250	0.625	151	184	16	24822-3357	EQUAL	6.000	7.000	0.625	152	178	16
21699-3343	53	5.938	7.250	0.625	151	184	16	24626-3362	26	6.000	7.000	0.750	152	178	19
29516-7110	IG	5.938	7.343	0.983	151	187	25	24600-3362	26	6.000	7.000	0.750	152	178	19
24816-7145	EQUAL	5.938	7.343	1.144	151	187	29	29502-3362	IG	6.000	7.000	0.750	152	178	19
25003-3344	23	5.938	7.375	0.500	151	187	13	29522-3362	IG	6.000	7.000	0.750	152	178	19
21086-3344	53	5.938	7.375	0.500	151	187	13	22627-6746	53R2	6.000	7.000	0.969	152	178	25
25003-7214	23	5.938	7.437	0.750	151	189	19	22897-6746	53T2	6.000	7.000	0.969	152	178	25
25003-2793	23	5.938	7.438	0.500	151	189	13	29502-5555	IG	6.000	7.059	0.750	152	179	19
25003-3347	23	5.938	7.500	0.500	151	191	13	25003-4789	23	6.000	7.085	0.438	152	180	11
21086-3347	53	5.938	7.500	0.500	151	191	13	25003-2680	23	6.000	7.125	0.437	152	181	11
24060-3347	61	5.938	7.500	0.500	151	191	13	21086-3358	53	6.000	7.125	0.500	152	181	13
25003-3351	23	5.938	7.625	0.500	151	194	13	21699-3358	53	6.000	7.125	0.500	152	181	13
21086-3351	53	5.938	7.625	0.500	151	194	13	25003-3359	23	6.000	7.125	0.563	152	181	14
25003-9031	23	5.938	7.688	0.625	151	195	16	21086-3359	53	6.000	7.125	0.563	152	181	14
24610-5811	26	5.987	7.562	0.630	152	192	16	21699-3359	53	6.000	7.125	0.563	152	181	14
21005-3045	58	6.000	6.750	0.375	152	171	10	25003-3360	23	6.000	7.125	0.625	152	181	16
29602-5285	GD	6.000	6.750	0.700	152	171	18	24600-6042	26	6.000	7.125	0.625	152	181	16
29502-5285	IG	6.000	6.750	0.750	152	171	19	21086-3360	53	6.000	7.125	0.625	152	181	16
25003-0530	23	6.000	7.000	0.375	152	178	10	21699-3360	53	6.000	7.125	0.625	152	181	16
25010-9939	23	6.000	7.000	0.375	152	178	10	29602-5991	GD	6.000	7.125	0.700	152	181	18
24629-3354	26R1	6.000	7.000	0.437	152	178	11	29502-5991	IG	6.000	7.125	0.750	152	181	19
25010-6165	23	6.000	7.000	0.438	152	178	11	22537-1178	53R1	6.000	7.125	0.906	152	181	23
25003-6165	23	6.000	7.000	0.438	152	178	11	25003-3225	23	6.000	7.250	0.375	152	184	10
24620-3354	26R1	6.000	7.000	0.438	152	178	11	25135-3361	23	6.000	7.250	0.500	152	184	13
24600-3354	26	6.000	7.000	0.438	152	178	11	25003-3361	23	6.000	7.250	0.500	152	184	13
24610-3354	26	6.000	7.000	0.438	152	178	11	25006-3361	23	6.000	7.250	0.500	152	184	13
21012-3355	113	6.000	7.000	0.500	152	178	13	24626-3361	26	6.000	7.250	0.500	152	184	13
25010-3355	23	6.000	7.000	0.500	152	178	13	24600-3361	26	6.000	7.250	0.500	152	184	13
25138-3355	23	6.000	7.000	0.500	152	178	13	21096-3361	53	6.000	7.250	0.500	152	184	13
25003-3355	23	6.000	7.000	0.500	152	178	13	21086-3361	53	6.000	7.250	0.500	152	184	13
25006-3355	23	6.000	7.000	0.500	152	178	13	21095-3361	53	6.000	7.250	0.500	152	184	13
25004-3355	23	6.000	7.000	0.500	152	178	13	25003-3363	23	6.000	7.250	0.625	152	184	16
25058-3355	25	6.000	7.000	0.500	152	178	13	25006-3363	23	6.000	7.250	0.625	152	184	16
25059-3355	25	6.000	7.000	0.500	152	178	13	24610-2338	26	6.000	7.250	0.625	152	184	16
25007-3355	25	6.000	7.000	0.500	152	178	13	21086-3363	53	6.000	7.250	0.625	152	184	16
24622-3355	26R1	6.000	7.000	0.500	152	178	13	21699-3363	53	6.000	7.250	0.625	152	184	16
24610-3355	26	6.000	7.000	0.500	152	178	13	21702-3363	62	6.000	7.250	0.625	152	184	16
21020-3355	50	6.000	7.000	0.500	152	178	13	22903-4868	53T2	6.000	7.250	0.969	152	184	25
21096-3355	53	6.000	7.000	0.500	152	178	13	24816-7040	EQUAL	6.000	7.340	1.375	152	186	35
21597-3355	53	6.000	7.000	0.500	152	178	13	29516-5504	IG	6.000	7.343	0.983	152	187	25
21086-3355	53	6.000	7.000	0.500	152	178	13	24816-7068	EQUAL	6.000	7.343	1.375	152	187	35
21095-3355	53	6.000	7.000	0.500	152	178	13	25003-3364	23	6.000	7.375	0.500	152	187	13
21947-3355	53	6.000	7.000	0.500	152	178	13	25006-3364	23	6.000	7.375	0.500	152	187	13
21699-3355	53	6.000	7.000	0.500	152	178	13	21086-3364	53	6.000	7.375	0.500	152	187	13
26063-3355	57	6.000	7.000	0.500	152	178	13	29500-5481	IG	6.000	7.375	0.750	152	187	19
26057-3355	57	6.000	7.000	0.500	152	178	13	29502-5481	IG	6.000	7.375	0.750	152	187	19
26058-3355	57	6.000	7.000	0.500	152	178	13	25003-3196	23	6.000	7.406	0.588	152	188	15
24700-3355	59	6.000	7.000	0.500	152	178	13	25003-9458	23	6.000	7.452	0.734	152	189	19
21702-3355	62	6.000	7.000	0.500	152	178	13	24602-2966	26	6.000	7.490	0.500	152	190	13
21086-3356	53	6.000	7.000	0.563	152	178	14	25003-1172	23	6.000	7.500	0.375	152	191	10

All dimensions are in inches. Preferred sizes are indicated with **bold** type face.

Sizes listed are for standard nitrile elements, except Models 25 and 62 which have PTFE elements. Other material available on inquiry only.

## Oil Seals by Model Number

Product Code	Model	Inches			MM			Product Code	Model	Inches			MM		
		ID	OD	Width	ID	OD	Width			ID	OD	Width	ID	OD	Width
24626-3379	26	6.000	7.500	0.375	152	191	10	29519-6887	IG	6.004	6.996	0.625	153	178	16
24600-3379	26	6.000	7.500	0.375	152	191	10	25003-9245	23	6.031	7.312	0.500	153	186	13
25003-3367	23	6.000	7.500	0.500	152	191	13	25003-2560	23	6.062	7.062	0.375	154	179	10
25006-3367	23	6.000	7.500	0.500	152	191	13	24610-6582	26	6.062	7.312	0.625	154	186	16
25005-3367	24	6.000	7.500	0.500	152	191	13	25003-9099	23	6.062	7.313	0.625	154	186	16
25058-3367	25	6.000	7.500	0.500	152	191	13	24816-7014	EQUAL	6.062	7.349	1.375	154	187	35
21096-3367	53	6.000	7.500	0.500	152	191	13	25003-5661	23	6.062	7.375	0.500	154	187	13
21087-3367	53	6.000	7.500	0.500	152	191	13	21699-4490	53	6.062	7.500	0.500	154	191	13
21086-3367	53	6.000	7.500	0.500	152	191	13	25003-1393	23	6.062	7.500	0.750	154	191	19
21095-3367	53	6.000	7.500	0.500	152	191	13	24822-3730	EQUAL	6.062	7.550	0.625	154	192	16
21699-3367	53	6.000	7.500	0.500	152	191	13	25003-2890	23	6.063	7.063	0.390	154	179	10
24715-3367	59	6.000	7.500	0.500	152	191	13	25003-3376	23	6.063	7.063	0.438	154	179	11
24060-3367	61	6.000	7.500	0.500	152	191	13	25003-1706	23	6.063	7.087	0.413	154	180	10
21702-3367	62	6.000	7.500	0.500	152	191	13	25003-5057	23	6.063	7.125	0.500	154	181	13
25010-3369	23	6.000	7.500	0.625	152	191	16	29516-7074	IG	6.063	7.343	0.977	154	187	25
25003-3369	23	6.000	7.500	0.625	152	191	16	25003-4490	23	6.063	7.500	0.500	154	191	13
25006-3369	23	6.000	7.500	0.625	152	191	16	21086-4490	53	6.063	7.500	0.500	154	191	13
24610-1024	26	6.000	7.500	0.625	152	191	16	29502-5712	IG	6.063	7.500	0.750	154	191	19
24610-3389	26	6.000	7.500	0.625	152	191	16	22627-4446	53R2	6.063	7.500	0.906	154	191	23
22501-3369	53G1	6.000	7.500	0.625	152	191	16	25003-5119	23	6.063	7.563	0.750	154	192	19
21096-3369	53	6.000	7.500	0.625	152	191	16	24063-2281	61	6.100	6.875	0.625	155	175	16
21086-3369	53	6.000	7.500	0.625	152	191	16	24600-3326	26	6.102	6.850	0.472	155	174	12
24700-1024	59	6.000	7.500	0.625	152	191	16	24637-3313	26	6.102	6.968	.472	155	177	12
24702-1024	59	6.000	7.500	0.625	152	191	16	25003-1269	23	6.102	7.087	0.500	155	180	13
24802-1024	EQUAL	6.000	7.500	0.625	152	191	16	24620-3352	26R1	6.102	7.087	0.591	155	180	15
24822-1024	EQUAL	6.000	7.500	0.625	152	191	16	24822-6004	EQUAL	6.102	7.087	0.625	155	180	16
29602-3370	GD	6.000	7.500	0.700	152	191	18	25003-6982	23	6.102	7.102	0.500	155	180	13
25284-3370	23	6.000	7.500	0.750	152	191	19	25003-3272	23	6.102	7.283	0.591	155	185	15
25003-3370	23	6.000	7.500	0.750	152	191	19	24638-3311	26	6.102	7.283	.591	155	185	15
25058-3370	25	6.000	7.500	0.750	152	191	19	29518-7416	IG	6.102	7.875	0.875	155	200	22
24606-3370	26R1	6.000	7.500	0.750	152	191	19	24700-3352	59	6.102	7.087	0.591	155	180	15
24627-3370	26	6.000	7.500	0.750	152	191	19	24780-3352	59	6.102	7.087	0.591	155	180	15
21086-3370	53	6.000	7.500	0.750	152	191	19	25003-9232	23	6.125	7.000	0.500	156	178	13
24702-3370	59	6.000	7.500	0.750	152	191	19	25135-3375	23	6.125	7.125	0.500	156	181	13
24060-3370	61	6.000	7.500	0.750	152	191	19	25003-3375	23	6.125	7.125	0.500	156	181	13
29500-3370	IG	6.000	7.500	0.750	152	191	19	25006-3375	23	6.125	7.125	0.500	156	181	13
29502-3370	IG	6.000	7.500	0.750	152	191	19	21091-3375	53	6.125	7.125	0.500	156	181	13
22987-7433	53F1	6.000	7.500	0.906	152	191	23	21086-3375	53	6.125	7.125	0.500	156	181	13
22537-7433	53R1	6.000	7.500	0.906	152	191	23	21095-3375	53	6.125	7.125	0.500	156	181	13
22634-7433	53R2	6.000	7.500	0.906	152	191	23	21699-3375	53	6.125	7.125	0.500	156	181	13
22627-7433	53R2	6.000	7.500	0.906	152	191	23	24610-2170	26	6.125	7.125	0.562	156	181	14
24627-3389	26	6.000	7.508	0.625	152	191	16	24620-3377	26R1	6.125	7.125	0.625	156	181	16
24600-3389	26	6.000	7.508	0.625	152	191	16	24600-3377	26	6.125	7.125	0.625	156	181	16
24626-3389	26	6.000	7.508	0.625	152	191	16	21086-3377	53	6.125	7.125	0.625	156	181	16
24612-1167	26	6.000	7.520	0.625	152	191	16	24821-3377	EQUAL	6.125	7.125	0.625	156	181	16
24610-5601	26	6.000	7.562	0.781	152	192	20	29500-4310	IG	6.125	7.125	0.750	156	181	19
21086-3371	53	6.000	7.625	0.500	152	194	13	29522-4310	IG	6.125	7.125	0.750	156	181	19
21086-3372	53	6.000	7.625	0.563	152	194	14	25003-3378	23	6.125	7.250	0.500	156	184	13
25003-3373	23	6.000	7.625	0.625	152	194	16	24602-3200	26	6.125	7.250	0.500	156	184	13
24660-3373	26HR	6.000	7.625	0.625	152	194	16	21096-3378	53	6.125	7.250	0.500	156	184	13
24600-3373	26	6.000	7.625	0.625	152	194	16	21087-3378	53	6.125	7.250	0.500	156	184	13
21086-3374	53	6.000	7.625	0.750	152	194	19	21086-3378	53	6.125	7.250	0.500	156	184	13
29516-7376	IG	6.000	7.756	1.169	152	197	30	21699-3378	53	6.125	7.250	0.500	156	184	13
24627-3536	26	6.000	8.000	0.500	152	203	13	25003-3380	23	6.125	7.250	0.625	156	184	16
25001-4780	21	6.000	8.250	0.750	152	210	19	21086-3380	53	6.125	7.250	0.625	156	184	16
25003-0803	23	6.002	7.002	0.500	152	178	13	25135-1524	23	6.125	7.307	0.591	156	186	15

All dimensions are in inches. Preferred sizes are indicated with **bold** type face. Sizes listed are for standard nitrile elements, except Models 25 and 62 which have PTFE elements. Other material available on inquiry only.

## Oil Seals by Model Number

Product Code	Model	Inches			MM			Product Code	Model	Inches			MM		
		ID	OD	Width	ID	OD	Width			ID	OD	Width	ID	OD	Width
25003-1524	23	6.125	7.307	0.591	156	186	15	21699-3388	53	6.250	7.250	0.500	159	184	13
25010-3381	23	6.125	7.375	0.500	156	187	13	29619-4312	GD	6.250	7.250	0.625	159	184	16
25003-3381	23	6.125	7.375	0.500	156	187	13	24822-2786	EQUAL	6.250	7.250	0.625	159	184	16
21086-3381	53	6.125	7.375	0.500	156	187	13	29602-4312	GD	6.250	7.250	0.700	159	184	18
21699-3381	53	6.125	7.375	0.500	156	187	13	29500-4312	IG	6.250	7.250	0.750	159	184	19
25003-3383	23	6.125	7.375	0.625	156	187	16	29502-4312	IG	6.250	7.250	0.750	159	184	19
21086-3384	53	6.125	7.500	0.500	156	191	13	22537-7330	53R1	6.250	7.250	0.906	159	184	23
21699-3384	53	6.125	7.500	0.500	156	191	13	22543-7330	53R1	6.250	7.250	0.906	159	184	23
25003-3387	23	6.125	7.500	0.750	156	191	19	22897-7864	53T2	6.250	7.250	0.969	159	184	25
21086-3387	53	6.125	7.500	0.750	156	191	19	29516-7073	IG	6.250	7.343	0.970	159	187	25
29502-6587	IG	6.125	7.500	0.750	156	191	19	29616-7073	GD	6.250	7.343	1.297	159	187	33
22627-6146	53R2	6.125	7.500	0.906	156	191	23	21086-3391	53	6.250	7.375	0.500	159	187	13
22987-5884	53F1	6.125	7.500	0.969	156	191	25	25003-3394	23	6.250	7.500	0.500	159	191	13
25003-8169	23	6.125	7.625	0.500	156	194	13	25006-3394	23	6.250	7.500	0.500	159	191	13
25003-6602	23	6.125	7.625	0.625	156	194	16	24602-3394	26	6.250	7.500	0.500	159	191	13
25009-6602	23	6.125	7.625	0.625	156	194	16	21087-3394	53	6.250	7.500	0.500	159	191	13
24600-3418	26	6.125	7.625	0.625	156	194	16	21091-3394	53	6.250	7.500	0.500	159	191	13
21597-6602	53	6.125	7.625	0.625	156	194	16	21086-3394	53	6.250	7.500	0.500	159	191	13
21086-6602	53	6.125	7.625	0.625	156	194	16	21100-3394	53	6.250	7.500	0.500	159	191	13
24821-3418	EQUAL	6.125	7.625	0.625	156	194	16	21095-3394	53	6.250	7.500	0.500	159	191	13
21238-1299	64	6.125	7.625	0.688	156	194	17	21947-3394	53	6.250	7.500	0.500	159	191	13
21852-1299	64	6.125	7.625	0.688	156	194	17	21699-3394	53	6.250	7.500	0.500	159	191	13
25003-4729	23	6.125	7.625	0.750	156	194	19	25003-3395	23	6.250	7.500	0.562	159	191	14
21086-4729	53	6.125	7.625	0.750	156	194	19	21086-3395	53	6.250	7.500	0.563	159	191	14
26095-4729	87	6.125	7.625	0.750	156	194	19	25003-3396	23	6.250	7.500	0.625	159	191	16
29502-5583	IG	6.125	7.625	0.750	156	194	19	25006-3396	23	6.250	7.500	0.625	159	191	16
25006-7789	23	6.188	7.188	0.500	157	183	13	24610-3396	26	6.250	7.500	0.625	159	191	16
25003-5563	23	6.188	7.250	0.500	157	184	13	21020-3396	50	6.250	7.500	0.625	159	191	16
25003-8654	23	6.188	7.437	0.625	157	189	16	21086-3396	53	6.250	7.500	0.625	159	191	16
25003-7719	23	6.188	7.438	0.500	157	189	13	21699-3396	53	6.250	7.500	0.625	159	191	16
25003-4369	23	6.188	7.500	0.500	157	191	13	21086-3397	53	6.250	7.500	0.750	159	191	19
25003-7472	23	6.188	7.500	0.625	157	191	16	29500-4865	IG	6.250	7.500	0.750	159	191	19
25009-7472	23	6.188	7.500	0.625	157	191	16	25003-3398	23	6.250	7.625	0.500	159	194	13
24600-4388	26	6.188	7.508	0.250	157	191	6	21086-3398	53	6.250	7.625	0.500	159	194	13
24600-3390	26	6.188	7.688	0.750	157	195	19	25003-7264	23	6.250	7.688	0.625	159	195	16
29502-5524	IG	6.218	8.062	0.750	158	205	19	25003-3402	23	6.250	7.750	0.500	159	197	13
25003-4775	23	6.220	7.750	0.625	158	197	16	21086-3402	53	6.250	7.750	0.500	159	197	13
25003-1004	23	6.221	7.250	0.500	158	184	13	21699-3402	53	6.250	7.750	0.500	159	197	13
24600-6867	26	6.229	7.549	0.625	158	192	16	25003-3404	23	6.250	7.750	0.625	159	197	16
24802-1764	EQUAL	6.250	7.125	0.625	159	181	16	29602-3405	GD	6.250	7.750	0.700	159	197	18
24822-1764	EQUAL	6.250	7.125	0.625	159	181	16	25003-3405	23	6.250	7.750	0.750	159	197	19
25003-4551	23	6.250	7.185	0.500	159	182	13	21096-3405	53	6.250	7.750	0.750	159	197	19
25003-0527	23	6.250	7.250	0.375	159	184	10	21086-3405	53	6.250	7.750	0.750	159	197	19
25003-6450	23	6.250	7.250	0.438	159	184	11	21702-3405	62	6.250	7.750	0.750	159	197	19
24622-6450	26R1	6.250	7.250	0.438	159	184	11	29502-3405	IG	6.250	7.750	0.750	159	197	19
24600-6450	26	6.250	7.250	0.438	159	184	11	22627-7247	53R2	6.250	7.750	0.906	159	197	23
24602-6450	26	6.250	7.250	0.438	159	184	11	25006-3260	23	6.250	7.875	0.625	159	200	16
25003-3388	23	6.250	7.250	0.500	159	184	13	25003-5637	23	6.280	7.530	0.625	160	191	16
25006-3388	23	6.250	7.250	0.500	159	184	13	25003-6922	23	6.281	7.280	0.375	160	185	10
24620-0678	26R1	6.250	7.250	0.500	159	184	13	25003-1391	23	6.298	7.500	0.375	160	191	10
24608-0678	26R1	6.250	7.250	0.500	159	184	13	25004-3269	23	6.299	7.274	0.750	160	185	19
24627-0678	26	6.250	7.250	0.500	159	184	13	25010-9789	23	6.299	7.299	0.500	160	185	13
24610-0678	26	6.250	7.250	0.500	159	184	13	25003-9789	23	6.299	7.299	0.500	160	185	13
21096-3388	53	6.250	7.250	0.500	159	184	13	25006-9789	23	6.299	7.299	0.500	160	185	13
21087-3388	53	6.250	7.250	0.500	159	184	13	29502-6085	IG	6.299	7.313	0.750	160	186	19
21086-3388	53	6.250	7.250	0.500	159	184	13	25003-4634	23	6.299	7.480	0.500	160	190	13

All dimensions are in inches. Preferred sizes are indicated with **bold** type face.

Sizes listed are for standard nitrile elements, except Models 25 and 62 which have PTFE elements. Other material available on inquiry only.



## Oil Seals by Model Number

Product Code	Model	Inches			MM			Product Code	Model	Inches			MM		
		ID	OD	Width	ID	OD	Width			ID	OD	Width	ID	OD	Width
25003-7816	23	6.299	7.480	0.511	160	190	13	25010-3406	23	6.375	7.375	0.500	162	187	13
25006-7816	23	6.299	7.480	0.511	160	190	13	25003-3406	23	6.375	7.375	0.500	162	187	13
26057-7816	57	6.299	7.480	0.512	160	190	13	25006-3406	23	6.375	7.375	0.500	162	187	13
21947-7276	53	6.299	7.480	0.590	160	190	15	21096-3406	53	6.375	7.375	0.500	162	187	13
25003-7276	23	6.299	7.480	0.591	160	190	15	21086-3406	53	6.375	7.375	0.500	162	187	13
25006-7276	23	6.299	7.480	0.591	160	190	15	21095-3406	53	6.375	7.375	0.500	162	187	13
25009-7276	23	6.299	7.480	0.591	160	190	15	21699-3406	53	6.375	7.375	0.500	162	187	13
24637-7276	26	6.299	7.480	.591	160	190	15	21767-3406	62	6.375	7.375	0.500	162	187	13
24638-7276	26	6.299	7.480	.591	160	190	15	29500-4542	1G	6.375	7.375	0.750	162	187	19
24620-7276	26R1	6.299	7.480	0.591	160	190	15	29502-4542	1G	6.375	7.498	0.750	162	190	19
24626-7276	26	6.299	7.480	0.591	160	190	15	25003-3409	23	6.375	7.500	0.500	162	191	13
24627-7276	26	6.299	7.480	0.591	160	190	15	21086-3409	53	6.375	7.500	0.500	162	191	13
21096-7276	53	6.299	7.480	0.591	160	190	15	21699-3409	53	6.375	7.500	0.500	162	191	13
21086-7276	53	6.299	7.480	0.591	160	190	15	25003-3419	23	6.375	7.500	0.625	162	191	16
21699-7276	53	6.299	7.480	0.591	160	190	15	22897-7609	53T2	6.375	7.500	0.969	162	191	25
26057-7276	57	6.299	7.480	0.591	160	190	15	25003-3413	23	6.375	7.625	0.500	162	194	13
29519-6130	1G	6.299	7.480	0.625	160	190	16	21086-3413	53	6.375	7.625	0.500	162	194	13
24801-3913	EQUAL	6.299	7.480	0.625	160	190	16	21095-3413	53	6.375	7.625	0.500	162	194	13
24821-3913	EQUAL	6.299	7.480	0.625	160	190	16	25018-3415	21	6.375	7.625	0.625	162	194	16
25003-3913	23	6.299	7.480	0.629	160	190	16	25003-3415	23	6.375	7.625	0.625	162	194	16
24650-3913	26NS	6.299	7.480	0.630	160	190	16	25006-3415	23	6.375	7.625	0.625	162	194	16
29500-4998	1G	6.299	7.480	0.750	160	190	19	21086-3415	53	6.375	7.625	0.625	162	194	16
29502-4998	1G	6.299	7.480	0.750	160	190	19	21095-3415	53	6.375	7.625	0.625	162	194	16
25003-6867	23	6.299	7.549	0.625	160	192	16	21699-3415	53	6.375	7.625	0.625	162	194	16
25010-6867	23	6.299	7.549	0.625	160	192	16	25003-3417	23	6.375	7.750	0.500	162	197	13
25003-3882	23	6.299	7.677	0.629	160	195	16	21086-3417	53	6.375	7.750	0.500	162	197	13
25003-4044	23	6.299	7.874	0.551	160	200	14	25003-4694	23	6.375	7.750	0.625	162	197	16
25003-1717	23	6.299	7.875	0.472	160	200	12	25003-3421	23	6.375	7.875	0.500	162	200	13
25001-4633	21	6.299	7.875	0.630	160	200	16	21086-3421	53	6.375	7.875	0.500	162	200	13
29518-7286	1G	6.299	7.875	0.820	160	200	21	21095-3421	53	6.375	7.875	0.500	162	200	13
25010-0578	23	6.299	7.943	0.625	160	202	16	21947-3421	53	6.375	7.875	0.500	162	200	13
25003-1394	23	6.299	7.244	0.551	160	184	14	21409-3421	53	6.375	7.875	0.500	162	200	13
26058-7816	57	6.299	7.480	0.512	160	190	13	21699-3421	53	6.375	7.875	0.500	162	200	13
24600-7276	26	6.299	7.480	0.591	160	190	15	25003-3423	23	6.375	7.875	0.625	162	200	16
24602-7276	26	6.299	7.480	0.591	160	190	15	24600-3423	26	6.375	7.875	0.625	162	200	16
24612-7276	26	6.299	7.480	0.591	160	190	15	21699-3423	53	6.375	7.875	0.625	162	200	16
26058-7276	57	6.299	7.480	0.591	160	190	15	25003-3424	23	6.375	7.875	0.750	162	200	19
26063-7276	57	6.299	7.480	0.591	160	190	15	21086-3424	53	6.375	7.875	0.750	162	200	19
24627-3913	26	6.299	7.480	0.630	160	190	16	21140-6022	54-L	6.380	14.000	0.875	162	356	22
24602-3913	26	6.299	7.480	0.630	160	190	16	29519-5741	1G	6.430	7.500	0.625	163	191	16
25003-4412	23	6.299	7.874	0.531	160	200	14	29502-5702	1G	6.430	7.500	0.750	163	191	19
24700-4038	59	6.299	7.874	0.551	160	200	14	21091-3917	53	6.437	7.500	0.500	163	191	13
24716-4038	59	6.299	7.874	0.551	160	200	14	21699-3917	53	6.437	7.500	0.500	163	191	13
24600-3404	26	6.300	7.480	0.295	160	190	7	21702-3917	62	6.437	7.500	0.500	163	191	13
24610-1853	26	6.300	7.480	0.630	160	190	16	24822-3731	EQUAL	6.437	7.550	0.625	163	192	16
24610-7276	26	6.300	7.481	0.591	160	190	15	25054-7924	23	6.437	7.687	0.625	163	195	16
24600-3913	26	6.300	7.481	0.630	160	190	16	25010-7924	23	6.437	7.687	0.625	163	195	16
25010-5628	23	6.300	7.781	0.500	160	198	13	24626-3424	26	6.437	7.687	0.625	163	195	16
25003-5628	23	6.300	7.781	0.500	160	198	13	24600-3424	26	6.437	7.687	0.625	163	195	16
24627-3558	26	6.300	7.800	0.750	160	198	19	24700-3424	59	6.437	7.687	0.625	163	195	16
25003-8194	23	6.313	7.313	0.500	160	186	13	24610-3424	26	6.437	7.688	0.625	163	195	16
25003-7597	23	6.313	7.313	0.625	160	186	16	24715-3424	59	6.437	7.688	0.625	163	195	16
29699-0024	GD	6.339	7.120	2.303	161	181	58	24802-3424	EQUAL	6.437	7.688	0.625	163	195	16
25003-2269	23	6.375	7.250	0.515	162	184	13	25003-9185	23	6.438	7.375	0.500	164	187	13
25135-1518	23	6.375	7.359	0.492	162	187	12	25003-7321	23	6.438	7.438	0.500	164	189	13
25003-9939	23	6.375	7.375	0.375	162	187	10	25006-7321	23	6.438	7.438	0.500	164	189	13

All dimensions are in inches. Preferred sizes are indicated with **bold** type face.  
 Sizes listed are for standard nitrile elements, except Models 25 and 62 which have PTFE elements. Other material available on inquiry only.

## Oil Seals by Model Number

Product Code	Model	Inches			MM			Product Code	Model	Inches			MM		
		ID	OD	Width	ID	OD	Width			ID	OD	Width	ID	OD	Width
29602-4315	GD	6.438	7.438	0.700	164	189	18	24626-9780	26	6.500	7.500	0.563	165	191	14
29500-4315	IG	6.438	7.438	0.750	164	189	19	24600-9780	26	6.500	7.500	0.563	165	191	14
29502-4315	IG	6.438	7.438	0.750	164	189	19	21086-9780	53	6.500	7.500	0.563	165	191	14
25003-3917	23	6.438	7.500	0.500	164	191	13	25003-3426	23	6.500	7.500	0.625	165	191	16
24626-3041	26	6.438	7.500	0.500	164	191	13	25006-3426	23	6.500	7.500	0.625	165	191	16
21086-3917	53	6.438	7.500	0.500	164	191	13	24610-3426	26	6.500	7.500	0.625	165	191	16
21095-3917	53	6.438	7.500	0.500	164	191	13	21096-3426	53	6.500	7.500	0.625	165	191	16
25003-4595	23	6.438	7.500	0.625	164	191	16	21086-3426	53	6.500	7.500	0.625	165	191	16
22634-6712	53R2	6.438	7.500	0.906	164	191	23	21409-3426	53	6.500	7.500	0.625	165	191	16
29502-5094	IG	6.438	7.687	0.750	164	195	19	21699-3426	53	6.500	7.500	0.625	165	191	16
25003-7924	23	6.438	7.688	0.625	164	195	16	24700-3426	59	6.500	7.500	0.625	165	191	16
24627-3424	26	6.438	7.688	0.625	164	195	16	29519-3426	IG	6.500	7.500	0.625	165	191	16
25003-3425	23	6.438	7.750	0.750	164	197	19	24822-3426	EQUAL	6.500	7.500	0.625	165	191	16
21086-3425	53	6.438	7.750	0.750	164	197	19	29502-4316	IG	6.500	7.500	0.750	165	191	19
21699-3425	53	6.438	7.750	0.750	164	197	19	29522-4316	IG	6.500	7.500	0.750	165	191	19
29516-7104	IG	6.438	7.780	0.980	164	198	25	22987-8149	53F1	6.500	7.500	0.781	165	191	20
24816-7043	EQUAL	6.438	7.780	1.375	164	198	35	22987-6920	53F1	6.500	7.500	0.844	165	191	21
25003-9823	23	6.438	7.938	0.625	164	202	16	22627-5531	53R2	6.500	7.500	0.906	165	191	23
25003-9021	23	6.438	7.938	0.750	164	202	19	22897-5531	53T2	6.500	7.500	0.906	165	191	23
25008-1702	21	6.440	7.969	0.750	164	202	19	25003-3428	23	6.500	7.625	0.625	165	194	16
29519-5655	IG	6.442	7.500	0.625	164	191	16	25006-3428	23	6.500	7.625	0.625	165	194	16
25003-3302	23	6.469	7.469	0.500	164	190	13	21096-3428	53	6.500	7.625	0.625	165	194	16
24626-6608	26	6.476	7.480	0.512	164	190	13	21086-3428	53	6.500	7.625	0.625	165	194	16
24600-1060	26	6.494	7.525	0.516	165	191	13	21477-3428	53	6.500	7.625	0.625	165	194	16
25003-0795	23	6.495	7.525	0.500	165	191	13	21947-3428	53	6.500	7.625	0.625	165	194	16
25003-0584	23	6.496	7.480	0.512	165	190	13	21699-3428	53	6.500	7.625	0.625	165	194	16
24602-5916	26	6.496	7.480	0.512	165	190	13	25003-7771	23	6.500	7.688	0.625	165	195	16
21003-0584	58	6.496	7.480	0.512	165	190	13	25003-6817	23	6.500	7.750	0.500	165	197	13
25003-3970	23	6.496	7.677	0.591	165	195	15	21086-6817	53	6.500	7.750	0.500	165	197	13
24629-5433	26R1	6.496	7.678	0.709	165	195	18	25135-3430	23	6.500	7.750	0.625	165	197	16
25003-1970	23	6.496	7.875	0.591	165	200	15	25003-3430	23	6.500	7.750	0.625	165	197	16
25003-3263	23	6.496	8.071	0.625	165	205	16	25004-3430	23	6.500	7.750	0.625	165	197	16
29519-6159	IG	6.496	8.071	0.625	165	205	16	24627-3430	26	6.500	7.750	0.625	165	197	16
29502-5810	IG	6.498	9.125	0.750	165	232	19	24600-3430	26	6.500	7.750	0.625	165	197	16
25003-3168	23	6.500	7.375	0.500	165	187	13	24610-3430	26	6.500	7.750	0.625	165	197	16
24060-1687	61	6.500	7.500	0.250	165	191	6	21086-3430	53	6.500	7.750	0.625	165	197	16
25010-1832	23	6.500	7.500	0.375	165	191	10	21699-3430	53	6.500	7.750	0.625	165	197	16
25003-1832	23	6.500	7.500	0.375	165	191	10	24801-3430	EQUAL	6.500	7.750	0.625	165	197	16
25003-9374	23	6.500	7.500	0.438	165	191	11	25003-3431	23	6.500	7.750	0.750	165	197	19
21012-4560	113	6.500	7.500	0.500	165	191	13	25003-8171	23	6.500	7.875	0.472	165	200	12
25010-4560	23	6.500	7.500	0.500	165	191	13	25005-8171	24	6.500	7.875	0.472	165	200	12
25135-4560	23	6.500	7.500	0.500	165	191	13	25003-3432	23	6.500	7.875	0.625	165	200	16
25003-4560	23	6.500	7.500	0.500	165	191	13	21086-3432	53	6.500	7.875	0.625	165	200	16
25144-4560	23	6.500	7.500	0.500	165	191	13	25003-9217	23	6.500	7.875	0.750	165	200	19
25006-4560	23	6.500	7.500	0.500	165	191	13	25003-5792	23	6.500	7.938	0.625	165	202	16
25004-4560	23	6.500	7.500	0.500	165	191	13	25003-6370	23	6.500	8.000	0.500	165	203	13
25009-4560	23	6.500	7.500	0.500	165	191	13	25144-6370	23	6.500	8.000	0.500	165	203	13
25007-4560	25	6.500	7.500	0.500	165	191	13	25006-6370	23	6.500	8.000	0.500	165	203	13
24627-0682	26	6.500	7.500	0.500	165	191	13	24629-6370	26R1	6.500	8.000	0.500	165	203	13
24610-0682	26	6.500	7.500	0.500	165	191	13	24620-6370	26R1	6.500	8.000	0.500	165	203	13
24626-6817	26	6.500	7.500	0.500	165	191	13	24627-6370	26	6.500	8.000	0.500	165	203	13
24627-6817	26	6.500	7.500	0.500	165	191	13	25003-3434	23	6.500	8.000	0.625	165	203	16
21098-4560	53	6.500	7.500	0.500	165	191	13	25004-3434	23	6.500	8.000	0.625	165	203	16
21702-4560	62	6.500	7.500	0.500	165	191	13	24620-3434	26R1	6.500	8.000	0.625	165	203	16
24602-9780	26	6.500	7.500	0.562	165	191	14	24627-3434	26	6.500	8.000	0.625	165	203	16
25003-9780	23	6.500	7.500	0.563	165	191	14	21096-3434	53	6.500	8.000	0.625	165	203	16

All dimensions are in inches. Preferred sizes are indicated with **bold** type face.

Sizes listed are for standard nitrile elements, except Models 25 and 62 which have PTFE elements. Other material available on inquiry only.

## Oil Seals by Model Number

Product Code	Model	Inches			MM			Product Code	Model	Inches			MM		
		ID	OD	Width	ID	OD	Width			ID	OD	Width	ID	OD	Width
21086-3434	53	6.500	8.000	0.625	165	203	16	24610-2233	26	6.625	8.125	0.625	168	206	16
29519-6544	1G	6.500	8.000	0.625	165	203	16	24610-5608	26	6.625	8.125	0.625	168	206	16
24820-3954	EQUAL	6.500	8.000	0.690	165	203	18	21087-3444	53	6.625	8.125	0.625	168	206	16
29602-3435	GD	6.500	8.000	0.700	165	203	18	21086-3444	53	6.625	8.125	0.625	168	206	16
25003-3435	23	6.500	8.000	0.750	165	203	19	21699-3444	53	6.625	8.125	0.625	168	206	16
25010-3435	23	6.500	8.000	0.750	165	203	19	25003-6172	23	6.625	8.125	0.688	168	206	17
25006-3435	23	6.500	8.000	0.750	165	203	19	25006-6172	23	6.625	8.125	0.688	168	206	17
24622-3435	26R1	6.500	8.000	0.750	165	203	19	25003-3445	23	6.625	8.125	0.750	168	206	19
24626-3435	26	6.500	8.000	0.750	165	203	19	21086-3445	53	6.625	8.125	0.750	168	206	19
24600-3435	26	6.500	8.000	0.750	165	203	19	22627-8775	53R2	6.625	8.125	0.969	168	206	25
24602-3435	26	6.500	8.000	0.750	165	203	19	25003-3446	23	6.625	8.250	0.625	168	210	16
21096-3435	53	6.500	8.000	0.750	165	203	19	21597-3446	53	6.625	8.250	0.625	168	210	16
21086-3435	53	6.500	8.000	0.750	165	203	19	21086-3446	53	6.625	8.250	0.625	168	210	16
24715-3435	59	6.500	8.000	0.750	165	203	19	21086-3447	53	6.625	8.250	0.750	168	210	19
22987-5211	53F1	6.500	8.000	0.844	165	203	21	25003-5691	23	6.625	8.375	0.500	168	213	13
24802-1185	EQUAL	6.500	8.000	1.000	165	203	25	21086-3448	53	6.625	8.375	0.625	168	213	16
29516-7377	1G	6.500	8.071	1.169	165	205	30	24816-7039	EQUAL	6.625	8.390	1.375	168	213	35
21086-6501	53	6.500	8.125	0.625	165	206	16	21086-3450	53	6.625	8.500	0.625	168	216	16
25001-5410	21	6.500	8.500	0.585	165	216	15	21699-3450	53	6.625	8.500	0.625	168	216	16
29602-9323	GD	6.500	8.500	0.700	165	216	18	24600-3135	26	6.625	8.750	0.500	168	222	13
25003-6371	23	6.563	7.563	0.500	167	192	13	21086-3454	53	6.625	8.750	0.625	168	222	16
24062-2800	61	6.625	7.500	0.500	168	191	13	21140-6023	54	6.625	12.500	0.625	168	318	16
25006-6897	23	6.625	7.625	0.500	168	194	13	21333-2695	143	6.630	7.942	0.781	168	202	20
25003-6897	23	6.625	7.625	0.500	168	194	13	25003-9958	23	6.670	7.750	0.500	169	197	13
25003-3436	23	6.625	7.625	0.625	168	194	16	24627-6106	26	6.672	7.902	0.750	169	201	19
24629-3436	26R1	6.625	7.625	0.625	168	194	16	24600-2940	26	6.679	7.406	0.250	170	188	6
21096-3436	53	6.625	7.625	0.625	168	194	16	25009-2629	23	6.687	8.250	0.500	170	210	13
21087-3436	53	6.625	7.625	0.625	168	194	16	25009-6229	23	6.688	7.688	0.500	170	195	13
21086-3436	53	6.625	7.625	0.625	168	194	16	25003-6229	23	6.688	7.688	0.500	170	195	13
21095-3436	53	6.625	7.625	0.625	168	194	16	25003-3471	23	6.688	7.750	0.500	170	197	13
21699-3436	53	6.625	7.625	0.625	168	194	16	21086-3918	53	6.688	7.750	0.625	170	197	16
29500-5522	1G	6.625	7.625	0.750	168	194	19	21699-3918	53	6.688	7.750	0.625	170	197	16
29516-7127	1G	6.625	7.718	1.116	168	196	28	25003-5032	23	6.688	7.938	0.500	170	202	13
24816-7054	EQUAL	6.625	7.719	1.250	168	196	32	25003-9828	23	6.688	8.007	0.625	170	203	16
24600-3438	26	6.625	7.725	0.305	168	196	8	25003-6818	23	6.690	7.940	0.625	170	202	16
25003-3438	23	6.625	7.750	0.625	168	197	16	25003-8445	23	6.692	8.192	0.750	170	208	19
21086-3438	53	6.625	7.750	0.625	168	197	16	25003-1395	23	6.693	7.638	0.551	170	194	14
21699-3438	53	6.625	7.750	0.625	168	197	16	25010-2826	23	6.693	7.874	0.472	170	200	12
21086-5677	53	6.625	7.875	0.500	168	200	13	25006-2826	23	6.693	7.874	0.472	170	200	12
25003-3440	23	6.625	7.875	0.625	168	200	16	24610-7268	26	6.693	7.874	0.591	170	200	15
25004-3440	23	6.625	7.875	0.625	168	200	16	24602-7268	26	6.693	7.874	0.591	170	200	15
21086-3440	53	6.625	7.875	0.625	168	200	16	26058-7268	57	6.693	7.874	0.591	170	200	15
29502-6109	1G	6.625	7.875	0.750	168	200	19	24600-3919	26	6.693	7.874	0.630	170	200	16
25003-4388	23	6.625	7.938	0.625	168	202	16	24626-3329	26	6.693	8.268	0.630	170	210	16
25003-8567	23	6.625	8.000	0.500	168	203	13	24627-3329	26	6.693	8.268	0.630	170	210	16
25003-3442	23	6.625	8.000	0.625	168	203	16	24600-3329	26	6.693	8.268	0.630	170	210	16
21096-3442	53	6.625	8.000	0.625	168	203	16	24637-4962	26	6.693	7.559	0.472	170	192	12
21086-3442	53	6.625	8.000	0.625	168	203	16	25003-0637	23	6.693	7.677	0.492	170	195	12
21699-3442	53	6.625	8.000	0.625	168	203	16	29699-0005	GD	6.693	7.717	0.700	170	196	18
29619-7308	GD	6.625	8.000	0.625	168	203	16	24600-3451	26	6.693	7.874	0.295	170	200	7
22501-2070	53G1	6.625	8.000	0.750	168	203	19	24626-3451	26	6.693	7.874	0.295	170	200	7
22987-6051	53F1	6.625	8.000	0.844	168	203	21	25003-4045	23	6.693	7.874	0.551	170	200	14
25003-5139	23	6.625	8.125	0.500	168	206	13	24629-7268	26R1	6.693	7.874	0.591	170	200	15
25005-5139	24	6.625	8.125	0.500	168	206	13	24620-7268	26R1	6.693	7.874	0.591	170	200	15
25003-3444	23	6.625	8.125	0.625	168	206	16	24619-7268	26R1	6.693	7.874	0.591	170	200	15
25006-3444	23	6.625	8.125	0.625	168	206	16	21409-7268	53	6.693	7.874	0.591	170	200	15

All dimensions are in inches. Preferred sizes are indicated with **bold** type face. Sizes listed are for standard nitrile elements, except Models 25 and 62 which have PTFE elements. Other material available on inquiry only.

## Oil Seals by Model Number

Product Code	Model	Inches			MM			Product Code	Model	Inches			MM		
		ID	OD	Width	ID	OD	Width			ID	OD	Width	ID	OD	Width
29519-3180	IG	6.693	7.874	0.625	170	200	16	21086-3458	53	6.750	7.875	0.625	171	200	16
24626-3919	26	6.693	7.874	0.630	170	200	16	25003-2983	23	6.750	8.000	0.375	171	203	10
24700-3919	59	6.693	7.874	0.630	170	200	16	25003-3252	23	6.750	8.000	0.500	171	203	13
29602-5000	GD	6.693	7.874	0.700	170	200	18	25003-3460	23	6.750	8.000	0.625	171	203	16
29620-5000	GD	6.693	7.874	0.700	170	200	18	25006-3460	23	6.750	8.000	0.625	171	203	16
22502-2162	53G1	6.693	7.874	0.716	170	200	18	24626-3460	26	6.750	8.000	0.625	171	203	16
29500-5000	IG	6.693	7.874	0.750	170	200	19	24600-3460	26	6.750	8.000	0.625	171	203	16
29521-6575	IG	6.693	7.874	0.875	170	200	22	24610-3460	26	6.750	8.000	0.625	171	203	16
25003-2826	23	6.693	7.875	0.472	170	200	12	24602-3460	26	6.750	8.000	0.625	171	203	16
25003-5356	23	6.693	7.875	0.492	170	200	12	21477-3460	53	6.750	8.000	0.625	171	203	16
26057-0783	57	6.693	7.875	0.512	170	200	13	21086-3460	53	6.750	8.000	0.625	171	203	16
24700-7268	59	6.693	7.875	0.590	170	200	15	21095-3460	53	6.750	8.000	0.625	171	203	16
25003-7268	23	6.693	7.875	0.591	170	200	15	21699-3460	53	6.750	8.000	0.625	171	203	16
25010-7268	23	6.693	7.875	0.591	170	200	15	22987-7436	53F1	6.750	8.000	0.719	171	203	18
25004-7268	23	6.693	7.875	0.591	170	200	15	29500-3467	IG	6.750	8.000	0.750	171	203	19
24612-7268	26	6.693	7.875	0.591	170	200	15	29502-3467	IG	6.750	8.000	0.750	171	203	19
21096-7268	53	6.693	7.875	0.591	170	200	15	25003-3462	23	6.750	8.125	0.625	171	206	16
21087-7268	53	6.693	7.875	0.591	170	200	15	21086-3462	53	6.750	8.125	0.625	171	206	16
21086-7268	53	6.693	7.875	0.591	170	200	15	29519-3462	IG	6.750	8.125	0.625	171	206	16
21947-7268	53	6.693	7.875	0.591	170	200	15	29500-5642	IG	6.750	8.125	0.750	171	206	19
26063-7268	57	6.693	7.875	0.591	170	200	15	29500-6173	IG	6.750	8.125	0.750	171	206	19
26057-7268	57	6.693	7.875	0.591	170	200	15	25003-9404	23	6.750	8.250	0.500	171	210	13
24780-7268	59	6.693	7.875	0.591	170	200	15	25006-9404	23	6.750	8.250	0.500	171	210	13
24802-3180	EQUAL	6.693	7.875	0.625	170	200	16	24610-2531	26	6.750	8.250	0.500	171	210	13
24821-3180	EQUAL	6.693	7.875	0.625	170	200	16	24700-0844	59	6.750	8.250	0.563	171	210	14
24702-3919	59	6.693	7.875	0.630	170	200	16	25003-3464	23	6.750	8.250	0.625	171	210	16
25003-8699	23	6.693	7.943	0.625	170	202	16	25006-3464	23	6.750	8.250	0.625	171	210	16
25010-8699	23	6.693	7.943	0.625	170	202	16	24610-3464	26	6.750	8.250	0.625	171	210	16
25003-5370	23	6.693	7.992	0.547	170	203	14	21096-3464	53	6.750	8.250	0.625	171	210	16
25005-9951	24	6.693	8.193	0.500	170	208	13	21086-3464	53	6.750	8.250	0.625	171	210	16
25003-3078	23	6.693	8.268	0.472	170	210	12	21699-3464	53	6.750	8.250	0.625	171	210	16
24660-3329	26HR	6.693	8.268	0.630	170	210	16	21003-3464	58	6.750	8.250	0.625	171	210	16
25003-3455	23	6.750	7.750	0.438	171	197	11	24700-3464	59	6.750	8.250	0.625	171	210	16
25003-6372	23	6.750	7.750	0.500	171	197	13	24801-3464	EQUAL	6.750	8.250	0.625	171	210	16
25006-6372	23	6.750	7.750	0.500	171	197	13	29602-3465	GD	6.750	8.250	0.700	171	210	18
25004-6372	23	6.750	7.750	0.500	171	197	13	25003-3465	23	6.750	8.250	0.750	171	210	19
24600-6372	26	6.750	7.750	0.500	171	197	13	21086-3465	53	6.750	8.250	0.750	171	210	19
24610-6372	26	6.750	7.750	0.500	171	197	13	21699-3465	53	6.750	8.250	0.750	171	210	19
24602-6372	26	6.750	7.750	0.500	171	197	13	29500-3465	IG	6.750	8.250	0.750	171	210	19
25003-3456	23	6.750	7.750	0.625	171	197	16	29502-3465	IG	6.750	8.250	0.750	171	210	19
25006-3456	23	6.750	7.750	0.625	171	197	16	22987-7572	53F1	6.750	8.250	0.781	171	210	20
21096-3456	53	6.750	7.750	0.625	171	197	16	21086-3466	53	6.750	8.375	0.625	171	213	16
21087-3456	53	6.750	7.750	0.625	171	197	16	25003-3241	23	6.750	8.500	0.500	171	216	13
21477-3456	53	6.750	7.750	0.625	171	197	16	25001-3468	21	6.750	8.500	0.625	171	216	16
21086-3456	53	6.750	7.750	0.625	171	197	16	25002-3468	21	6.750	8.500	0.625	171	216	16
21699-3456	53	6.750	7.750	0.625	171	197	16	21087-3468	53	6.750	8.500	0.625	171	216	16
24702-4606	59	6.750	7.750	0.625	171	197	16	21086-3468	53	6.750	8.500	0.625	171	216	16
21702-3456	62	6.750	7.750	0.625	171	197	16	21095-3468	53	6.750	8.500	0.625	171	216	16
24822-4606	EQUAL	6.750	7.750	0.625	171	197	16	21699-3468	53	6.750	8.500	0.625	171	216	16
29602-5287	GD	6.750	7.750	0.700	171	197	18	21086-3472	53	6.750	8.750	0.625	171	222	16
24700-5287	59	6.750	7.750	0.750	171	197	19	21699-3472	53	6.750	8.750	0.625	171	222	16
24702-5287	59	6.750	7.750	0.750	171	197	19	24820-3671	EQUAL	6.750	8.750	0.625	171	222	16
29502-5287	IG	6.750	7.750	0.750	171	197	19	24802-4607	EQUAL	6.750	8.750	0.875	171	222	22
25003-3459	23	6.750	7.875	0.375	171	200	10	25003-7063	23	6.781	8.031	0.625	172	204	16
25003-6890	23	6.750	7.875	0.500	171	200	13	24822-5695	EQUAL	6.804	8.304	0.625	173	211	16
25003-3458	23	6.750	7.875	0.625	171	200	16	24821-6066	EQUAL	6.804	8.304	0.750	173	211	19

All dimensions are in inches. Preferred sizes are indicated with **bold** type face.

Sizes listed are for standard nitrile elements, except Models 25 and 62 which have PTFE elements. Other material available on inquiry only.

## Oil Seals by Model Number

Product Code	Model	Inches			MM			Product Code	Model	Inches			MM		
		ID	OD	Width	ID	OD	Width			ID	OD	Width	ID	OD	Width
24802-5781	EQUAL	6.804	8.310	0.625	173	211	16	25003-1869	23	6.889	7.889	0.500	175	200	13
25003-4900	23	6.813	8.313	0.750	173	211	19	24782-4416	59	6.889	8.071	0.591	175	205	15
25003-1127	23	6.875	7.875	0.375	175	200	10	24780-4416	59	6.889	8.071	0.591	175	205	15
25003-3477	23	6.875	7.875	0.438	175	200	11	21086-7495	53	6.889	8.465	0.629	175	215	16
25003-8433	23	6.875	7.875	0.500	175	200	13	25003-2457	23	6.890	8.071	0.591	175	205	15
25004-8433	23	6.875	7.875	0.500	175	200	13	25045-2457	23	6.890	8.071	0.591	175	205	15
24700-0687	59	6.875	7.875	0.500	175	200	13	24782-4365	59	6.890	8.071	0.591	175	205	15
21096-3474	53	6.875	7.875	0.625	175	200	16	29502-6074	1G	6.890	8.366	0.750	175	212	19
21087-3474	53	6.875	7.875	0.625	175	200	16	24626-6204	26	6.890	8.465	0.591	175	215	15
21086-3474	53	6.875	7.875	0.625	175	200	16	25003-1388	23	6.890	8.465	0.625	175	215	16
21557-3474	53	6.875	7.875	0.625	175	200	16	25003-6597	23	6.906	8.156	0.625	175	207	16
21699-3474	53	6.875	7.875	0.625	175	200	16	29699-0021	GD	6.929	8.500	0.700	176	216	18
21003-3474	58	6.875	7.875	0.625	175	200	16	21086-4479	53	6.937	8.500	0.625	176	216	16
21702-3474	62	6.875	7.875	0.625	175	200	16	25003-6373	23	6.938	7.938	0.500	176	202	13
29502-5565	1G	6.875	7.875	0.750	175	200	19	25006-6373	23	6.938	7.938	0.500	176	202	13
22987-4853	53F1	6.875	7.875	0.969	175	200	25	25003-5731	23	6.938	8.000	0.625	176	203	16
25003-6199	23	6.875	8.000	0.438	175	203	11	24626-3511	26	6.938	8.000	0.625	176	203	16
25003-6951	23	6.875	8.000	0.500	175	203	13	24600-3511	26	6.938	8.000	0.625	176	203	16
25003-3476	23	6.875	8.000	0.625	175	203	16	24610-3511	26	6.938	8.000	0.625	176	203	16
21086-3476	53	6.875	8.000	0.625	175	203	16	25003-6258	23	6.938	8.062	0.500	176	205	13
21699-3476	53	6.875	8.000	0.625	175	203	16	25003-4477	23	6.938	8.125	0.625	176	206	16
25003-3216	23	6.875	8.062	0.563	175	205	14	21086-4477	53	6.938	8.125	0.625	176	206	16
25003-7274	23	6.875	8.125	0.500	175	206	13	21699-4477	53	6.938	8.125	0.625	176	206	16
21247-8134	64	6.875	8.125	0.562	175	206	14	25003-3490	23	6.938	8.125	0.750	176	206	19
25003-8134	23	6.875	8.125	0.563	175	206	14	29502-6128	1G	6.938	8.250	0.750	176	210	19
25003-3478	23	6.875	8.125	0.625	175	206	16	25003-6258	23	6.938	8.375	0.625	176	213	16
24612-6206	26	6.875	8.125	0.625	175	206	16	25010-4478	23	6.938	8.375	0.625	176	213	16
21086-3478	53	6.875	8.125	0.625	175	206	16	21086-4478	53	6.938	8.375	0.625	176	213	16
21557-3478	53	6.875	8.125	0.625	175	206	16	21699-4478	53	6.938	8.375	0.625	176	213	16
21095-3478	53	6.875	8.125	0.625	175	206	16	24060-4478	61	6.938	8.375	0.625	176	213	16
22627-8685	53R2	6.875	8.125	1.406	175	206	36	29516-7107	1G	6.938	8.383	0.977	176	213	25
22897-8685	53T2	6.875	8.125	1.406	175	206	36	29516-7109	1G	6.938	8.383	1.216	176	213	31
25003-3480	23	6.875	8.250	0.625	175	210	16	25003-7378	23	6.938	8.438	0.500	176	214	13
25006-3480	23	6.875	8.250	0.625	175	210	16	25003-4479	23	6.938	8.500	0.625	176	216	16
21087-3480	53	6.875	8.250	0.625	175	210	16	25003-4730	23	6.950	8.125	0.750	177	206	19
21086-3480	53	6.875	8.250	0.625	175	210	16	29502-6094	1G	6.998	8.003	0.750	178	203	19
21947-3480	53	6.875	8.250	0.625	175	210	16	24650-5331	26NS	7.000	7.864	0.500	178	200	13
24700-6267	59	6.875	8.250	0.625	175	210	16	25003-3257	23	7.000	8.000	0.375	178	203	10
21702-3480	62	6.875	8.250	0.625	175	210	16	24600-3452	26	7.000	8.000	0.437	178	203	11
25003-3481	23	6.875	8.250	0.750	175	210	19	24610-3452	26	7.000	8.000	0.437	178	203	11
29502-5667	1G	6.875	8.250	0.750	175	210	19	25003-3502	23	7.000	8.000	0.438	178	203	11
25003-3482	23	6.875	8.375	0.625	175	213	16	25003-6374	23	7.000	8.000	0.500	178	203	13
21086-3482	53	6.875	8.375	0.625	175	213	16	25006-6374	23	7.000	8.000	0.500	178	203	13
21699-3482	53	6.875	8.375	0.625	175	213	16	25004-6374	23	7.000	8.000	0.500	178	203	13
25003-3483	23	6.875	8.375	0.750	175	213	19	25058-6374	25	7.000	8.000	0.500	178	203	13
21086-3483	53	6.875	8.375	0.750	175	213	19	25064-6374	25	7.000	8.000	0.500	178	203	13
29516-7191	1G	6.875	8.383	0.977	175	213	25	25007-6374	25	7.000	8.000	0.500	178	203	13
24600-3486	26	6.875	8.384	0.625	175	213	16	24620-6374	26R1	7.000	8.000	0.500	178	203	13
24602-2870	26	6.875	8.500	0.500	175	216	13	24626-6374	26	7.000	8.000	0.500	178	203	13
21086-3484	53	6.875	8.500	0.625	175	216	16	24602-6374	26	7.000	8.000	0.500	178	203	13
21086-3485	53	6.875	8.500	0.750	175	216	19	24064-6374	61	7.000	8.000	0.500	178	203	13
21086-3488	53	6.875	8.750	0.625	175	222	16	24060-6374	61	7.000	8.000	0.500	178	203	13
25003-4624	23	6.889	7.874	0.591	175	200	15	24056-6374	61	7.000	8.000	0.500	178	203	13
25010-4624	23	6.889	7.874	0.591	175	200	15	26081-6374	87	7.000	8.000	0.500	178	203	13
25003-1709	23	6.889	7.875	0.472	175	200	12	26095-6374	87	7.000	8.000	0.500	178	203	13
25003-3251	23	6.889	7.875	0.500	175	200	13	26080-6374	87	7.000	8.000	0.500	178	203	13

All dimensions are in inches. Preferred sizes are indicated with **bold** type face.  
 Sizes listed are for standard nitrile elements, except Models 25 and 62 which have PTFE elements. Other material available on inquiry only.

## Oil Seals by Model Number

Product Code	Model	Inches			MM			Product Code	Model	Inches			MM		
		ID	OD	Width	ID	OD	Width			ID	OD	Width	ID	OD	Width
26097-6374	87	7.000	8.000	0.500	178	203	13	29516-7187	1G	7.000	8.383	0.977	178	213	25
25003-3492	23	7.000	8.000	0.625	178	203	16	25003-8434	23	7.000	8.406	0.588	178	214	15
25045-3492	23	7.000	8.000	0.625	178	203	16	25003-0983	23	7.000	8.450	0.563	178	215	14
25006-3492	23	7.000	8.000	0.625	178	203	16	25003-6375	23	7.000	8.500	0.500	178	216	13
24626-3492	26	7.000	8.000	0.625	178	203	16	25006-6375	23	7.000	8.500	0.500	178	216	13
24600-3492	26	7.000	8.000	0.625	178	203	16	25284-6375	23	7.000	8.500	0.500	178	216	13
24610-3492	26	7.000	8.000	0.625	178	203	16	25005-6375	24	7.000	8.500	0.500	178	216	13
21020-3492	50	7.000	8.000	0.625	178	203	16	25003-3500	23	7.000	8.500	0.625	178	216	16
21699-3492	53	7.000	8.000	0.625	178	203	16	25010-3500	23	7.000	8.500	0.625	178	216	16
21096-3492	53	7.000	8.000	0.625	178	203	16	25006-3500	23	7.000	8.500	0.625	178	216	16
21087-3492	53	7.000	8.000	0.625	178	203	16	24662-3500	26HR	7.000	8.500	0.625	178	216	16
21086-3492	53	7.000	8.000	0.625	178	203	16	24626-3500	26	7.000	8.500	0.625	178	216	16
21947-3492	53	7.000	8.000	0.625	178	203	16	24600-3500	26	7.000	8.500	0.625	178	216	16
21409-3492	53	7.000	8.000	0.625	178	203	16	24610-3500	26	7.000	8.500	0.625	178	216	16
24715-3492	59	7.000	8.000	0.625	178	203	16	21096-3500	53	7.000	8.500	0.625	178	216	16
24700-3492	59	7.000	8.000	0.625	178	203	16	21087-3500	53	7.000	8.500	0.625	178	216	16
24702-3492	59	7.000	8.000	0.625	178	203	16	21086-3500	53	7.000	8.500	0.625	178	216	16
21767-3492	62	7.000	8.000	0.625	178	203	16	21699-3500	53	7.000	8.500	0.625	178	216	16
21702-3492	62	7.000	8.000	0.625	178	203	16	24715-3500	59	7.000	8.500	0.625	178	216	16
29507-3492	1G	7.000	8.000	0.625	178	203	16	24700-3500	59	7.000	8.500	0.625	178	216	16
29502-3453	1G	7.000	8.000	0.750	178	203	19	25003-3501	23	7.000	8.500	0.750	178	216	19
22987-6433	53F1	7.000	8.000	0.844	178	203	21	25006-3501	23	7.000	8.500	0.750	178	216	19
22537-6433	53R1	7.000	8.000	0.844	178	203	21	25004-3501	23	7.000	8.500	0.750	178	216	19
24600-3494	26	7.000	8.125	0.625	178	206	16	24627-3501	26	7.000	8.500	0.750	178	216	19
21086-3494	53	7.000	8.125	0.625	178	206	16	24610-3501	26	7.000	8.500	0.750	178	216	19
21699-3494	53	7.000	8.125	0.625	178	206	16	21086-3501	53	7.000	8.500	0.750	178	216	19
25003-3495	23	7.000	8.125	0.750	178	206	19	24751-3501	59G1	7.000	8.500	0.750	178	216	19
21086-3495	53	7.000	8.125	0.750	178	206	19	24715-3501	59	7.000	8.500	0.750	178	216	19
25003-3094	23	7.000	8.188	0.625	178	208	16	24700-3501	59	7.000	8.500	0.750	178	216	19
25003-4924	23	7.000	8.250	0.500	178	210	13	21937-3501	64	7.000	8.500	0.750	178	216	19
25006-4924	23	7.000	8.250	0.500	178	210	13	29500-3501	1G	7.000	8.500	0.750	178	216	19
25004-4924	23	7.000	8.250	0.500	178	210	13	29502-3501	1G	7.000	8.500	0.750	178	216	19
25006-3496	23	7.000	8.250	0.625	178	210	16	22627-7360	53R2	7.000	8.500	0.875	178	216	22
25003-3496	23	7.000	8.250	0.625	178	210	16	29521-6093	1G	7.000	8.500	0.875	178	216	22
25145-3496	23	7.000	8.250	0.625	178	210	16	22987-6437	53F1	7.000	8.500	0.969	178	216	25
25010-3496	23	7.000	8.250	0.625	178	210	16	22627-6437	53R2	7.000	8.500	0.969	178	216	25
25004-3496	23	7.000	8.250	0.625	178	210	16	24627-5600	26	7.000	8.562	0.781	178	217	20
25058-3496	25	7.000	8.250	0.625	178	210	16	24610-5600	26	7.000	8.562	0.781	178	217	20
24610-3496	26	7.000	8.250	0.625	178	210	16	25001-0524	21	7.000	8.750	0.500	178	222	13
21096-3496	53	7.000	8.250	0.625	178	210	16	25001-3504	21	7.000	8.750	0.625	178	222	16
21086-3496	53	7.000	8.250	0.625	178	210	16	21086-3504	53	7.000	8.750	0.625	178	222	16
21699-3496	53	7.000	8.250	0.625	178	210	16	21699-3504	53	7.000	8.750	0.625	178	222	16
24822-3496	EQUAL	7.000	8.250	0.625	178	210	16	24751-6033	59G1	7.000	8.750	0.813	178	222	21
25003-3497	23	7.000	8.250	0.750	178	210	19	21140-6024	54	7.000	13.500	0.750	178	343	19
25006-3497	23	7.000	8.250	0.750	178	210	19	24600-4227	26	7.007	8.582	0.629	178	218	16
29502-3497	1G	7.000	8.250	0.750	178	210	19	25003-2064	23	7.010	8.510	0.500	178	216	13
29619-7324	GD	7.000	8.268	0.625	178	210	16	25003-3109	23	7.059	8.249	0.625	179	210	16
25003-6163	23	7.000	8.375	0.500	178	213	13	21334-2187	143	7.060	8.372	0.781	179	213	20
25003-3498	23	7.000	8.375	0.625	178	213	16	24816-7170	EQUAL	7.062	8.375	1.375	179	213	35
24610-2185	26	7.000	8.375	0.625	178	213	16	25003-9244	23	7.062	8.563	0.500	179	218	13
22501-3498	53G1	7.000	8.375	0.625	178	213	16	25006-9244	23	7.062	8.563	0.500	179	218	13
21086-3498	53	7.000	8.375	0.625	178	213	16	25003-9262	23	7.063	8.062	0.625	179	205	16
21699-3498	53	7.000	8.375	0.625	178	213	16	25003-7674	23	7.063	8.063	0.500	179	205	13
25003-3499	23	7.000	8.375	0.750	178	213	19	25003-9805	23	7.063	8.563	0.750	179	218	19
21003-3499	58	7.000	8.375	0.750	178	213	19	25003-5629	23	7.078	8.562	0.500	180	217	13
24816-7015	EQUAL	7.000	8.375	1.375	178	213	35	25003-6841	23	7.078	8.578	0.625	180	218	16

All dimensions are in inches. Preferred sizes are indicated with **bold** type face.

Sizes listed are for standard nitrile elements, except Models 25 and 62 which have PTFE elements. Other material available on inquiry only.

## Oil Seals by Model Number

Product Code	Model	Inches			MM			Product Code	Model	Inches			MM		
		ID	OD	Width	ID	OD	Width			ID	OD	Width	ID	OD	Width
25003-4826	23	7.086	8.086	0.500	180	205	13	21699-3506	53	7.125	8.125	0.625	181	206	16
25003-5336	23	7.086	8.267	0.492	180	210	12	25003-6402	23	7.125	8.250	0.469	181	210	12
25003-7807	23	7.086	8.267	0.591	180	210	15	25003-7740	23	7.125	8.250	0.500	181	210	13
25006-7807	23	7.086	8.267	0.591	180	210	15	25003-3508	23	7.125	8.250	0.625	181	210	16
25003-5371	23	7.086	8.385	0.547	180	213	14	21699-3508	53	7.125	8.250	0.625	181	210	16
25003-9858	23	7.086	8.586	0.750	180	218	19	21096-3508	53	7.125	8.250	0.625	181	210	16
24600-5919	26	7.087	7.874	0.591	180	200	15	21086-3508	53	7.125	8.250	0.625	181	210	16
25010-2828	23	7.087	8.268	0.472	180	210	12	24602-5323	26	7.125	8.250	0.750	181	210	19
25006-2828	23	7.087	8.268	0.472	180	210	12	24715-5323	59	7.125	8.250	0.750	181	210	19
24610-3508	26	7.087	8.268	0.551	180	210	14	24060-2404	61	7.125	8.375	0.500	181	213	13
24602-7807	26	7.087	8.268	0.591	180	210	15	25003-3510	23	7.125	8.375	0.625	181	213	16
24715-3920	59	7.087	8.268	0.630	180	210	16	21699-3510	53	7.125	8.375	0.625	181	213	16
24610-5625	26	7.087	8.465	0.626	180	215	16	21096-3510	53	7.125	8.375	0.625	181	213	16
25003-4457	23	7.087	8.465	0.630	180	215	16	21086-3510	53	7.125	8.375	0.625	181	213	16
24610-2541	26	7.087	8.661	0.787	180	220	20	24715-5284	59	7.125	8.375	0.625	181	213	16
26081-3177	87	7.087	8.661	0.787	180	220	20	24060-1731	61	7.125	8.500	0.500	181	216	13
26080-3177	87	7.087	8.661	0.787	180	220	20	25003-3512	23	7.125	8.500	0.625	181	216	16
25003-1616	23	7.087	8.071	0.512	180	205	13	25010-3512	23	7.125	8.500	0.625	181	216	16
29519-5783	IG	7.087	8.071	0.625	180	205	16	24600-3512	26	7.125	8.500	0.625	181	216	16
24627-3035	26	7.087	8.071	0.629	180	205	16	21086-3512	53	7.125	8.500	0.625	181	216	16
29502-5618	IG	7.087	8.087	0.750	180	205	19	24700-3512	59	7.125	8.500	0.625	181	216	16
29504-5618	IG	7.087	8.087	0.750	180	205	19	25003-1464	23	7.125	8.625	0.437	181	219	11
29699-0006	GD	7.087	8.110	0.700	180	206	18	25030-8173	24	7.125	8.625	0.500	181	219	13
21096-7807	53	7.087	8.267	0.591	180	210	15	21096-3514	53	7.125	8.625	0.625	181	219	16
21086-7807	53	7.087	8.267	0.591	180	210	15	21086-3514	53	7.125	8.625	0.625	181	219	16
21095-7807	53	7.087	8.267	0.591	180	210	15	25003-3515	23	7.125	8.625	0.750	181	219	19
25003-2828	23	7.087	8.268	0.472	180	210	12	24620-3515	26R1	7.125	8.625	0.750	181	219	19
24629-7807	26R1	7.087	8.268	0.591	180	210	15	21086-3515	53	7.125	8.625	0.750	181	219	19
24620-7807	26R1	7.087	8.268	0.591	180	210	15	21003-3515	58	7.125	8.625	0.750	181	219	19
24619-7807	26R1	7.087	8.268	0.591	180	210	15	22537-6089	53R1	7.125	8.625	1.094	181	219	28
24610-7807	26	7.087	8.268	0.591	180	210	15	21086-3516	53	7.125	8.750	0.625	181	222	16
24637-7807	26	7.087	8.268	0.591	180	210	15	29502-6759	IG	7.161	9.309	0.750	182	236	19
24064-7807	61	7.087	8.268	0.591	180	210	15	25010-7812	23	7.187	8.187	0.500	183	208	13
24060-7807	61	7.087	8.268	0.591	180	210	15	25003-1734	23	7.187	8.437	0.500	183	214	13
25003-3920	23	7.087	8.268	0.630	180	210	16	25054-8580	23	7.187	8.639	0.625	183	219	16
24626-3920	26	7.087	8.268	0.630	180	210	16	25003-7812	23	7.188	8.188	0.500	183	208	13
24600-3920	26	7.087	8.268	0.630	180	210	16	29502-6678	IG	7.188	8.250	0.750	183	210	19
26058-3920	57	7.087	8.268	0.630	180	210	16	25003-3521	23	7.188	8.437	0.625	183	214	16
26063-3920	57	7.087	8.268	0.630	180	210	16	24715-5378	59	7.188	8.500	0.500	183	216	13
24700-5625	59	7.087	8.465	0.625	180	215	16	25003-4886	23	7.188	8.563	0.625	183	218	16
24802-5625	EQUAL	7.087	8.465	0.625	180	215	16	24816-7132	EQUAL	7.188	8.570	0.928	183	218	24
29516-7216	IG	7.087	8.570	1.164	180	218	30	29516-7195	IG	7.188	8.570	1.164	183	218	30
24821-3070	EQUAL	7.087	8.587	0.750	180	218	19	25003-8580	23	7.188	8.639	0.625	183	219	16
25003-4054	23	7.087	8.661	0.551	180	220	14	25144-8580	23	7.188	8.639	0.625	183	219	16
25003-9994	23	7.087	8.661	0.625	180	220	16	25006-8580	23	7.188	8.639	0.625	183	219	16
29620-6600	GD	7.087	8.661	0.700	180	220	18	24715-3921	59	7.188	8.639	0.625	183	219	16
29502-6600	IG	7.087	8.661	0.750	180	220	19	24626-5273	26	7.188	8.640	0.625	183	219	16
24627-2541	26	7.087	8.661	0.787	180	220	20	24600-5273	26	7.188	8.640	0.625	183	219	16
24700-4039	59	7.087	8.662	0.630	180	220	16	24602-5273	26	7.188	8.640	0.625	183	219	16
24716-4039	59	7.087	8.662	0.630	180	220	16	24822-2979	EQUAL	7.188	8.640	0.750	183	219	19
24060-1724	61	7.125	8.000	0.375	181	203	10	25003-7811	23	7.188	8.686	0.625	183	221	16
21012-4561	113	7.125	8.125	0.500	181	206	13	25003-9956	23	7.207	8.225	0.500	183	209	13
25003-4561	23	7.125	8.125	0.500	181	206	13	29507-5724	IG	7.250	7.625	0.625	184	194	16
21086-4561	53	7.125	8.125	0.500	181	206	13	24627-5770	26	7.250	8.000	0.625	184	203	16
25003-3506	23	7.125	8.125	0.625	181	206	16	25003-6861	23	7.250	8.250	0.375	184	210	10
21086-3506	53	7.125	8.125	0.625	181	206	16	25003-6175	23	7.250	8.250	0.438	184	210	11

All dimensions are in inches. Preferred sizes are indicated with **bold** type face. Sizes listed are for standard nitrile elements, except Models 25 and 62 which have PTFE elements. Other material available on inquiry only.

## Oil Seals by Model Number

Product Code	Model	Inches			MM			Product Code	Model	Inches			MM		
		ID	OD	Width	ID	OD	Width			ID	OD	Width	ID	OD	Width
24600-6175	26	7.250	8.250	0.438	184	210	11	24802-1239	EQUAL	7.250	8.750	0.625	184	222	16
24610-6175	26	7.250	8.250	0.438	184	210	11	29602-3527	GD	7.250	8.750	0.700	184	222	18
25010-6376	23	7.250	8.250	0.500	184	210	13	25003-3527	23	7.250	8.750	0.750	184	222	19
25003-6376	23	7.250	8.250	0.500	184	210	13	24627-3527	26	7.250	8.750	0.750	184	222	19
25006-6376	23	7.250	8.250	0.500	184	210	13	21086-3527	53	7.250	8.750	0.750	184	222	19
25004-6376	23	7.250	8.250	0.500	184	210	13	24715-3527	59	7.250	8.750	0.750	184	222	19
24612-0691	26	7.250	8.250	0.500	184	210	13	21003-2692	58	7.250	8.750	0.875	184	222	22
25003-3518	23	7.250	8.250	0.625	184	210	16	24821-5639	EQUAL	7.250	9.056	0.625	184	230	16
25006-3518	23	7.250	8.250	0.625	184	210	16	29620-6642	GD	7.255	8.997	0.700	184	229	18
24620-3518	26R1	7.250	8.250	0.625	184	210	16	25003-2065	23	7.256	8.756	0.500	184	222	13
24610-3518	26	7.250	8.250	0.625	184	210	16	25010-0801	23	7.283	8.268	0.500	185	210	13
21096-3518	53	7.250	8.250	0.625	184	210	16	25003-0801	23	7.283	8.268	0.500	185	210	13
21086-3518	53	7.250	8.250	0.625	184	210	16	25003-2081	23	7.283	8.283	0.500	185	210	13
21947-3518	53	7.250	8.250	0.625	184	210	16	25003-2643	23	7.283	8.464	0.590	185	215	15
21683-3518	53	7.250	8.250	0.625	184	210	16	24700-0001	59	7.283	8.850	0.625	185	225	16
21699-3518	53	7.250	8.250	0.625	184	210	16	25003-3641	23	7.283	8.858	0.625	185	225	16
21702-3518	62	7.250	8.250	0.625	184	210	16	24780-4321	59	7.283	8.859	0.630	185	225	16
24801-3518	EQUAL	7.250	8.250	0.625	184	210	16	24700-4321	59	7.283	8.859	0.630	185	225	16
22537-9087	53R1	7.250	8.250	1.156	184	210	29	25003-6888	23	7.312	8.438	0.562	186	214	14
22627-5500	53R2	7.250	8.250	1.344	184	210	34	21086-4492	53	7.313	8.375	0.625	186	213	16
21086-3520	53	7.250	8.375	0.625	184	213	16	21767-4492	62	7.313	8.375	0.625	186	213	16
25003-6556	23	7.250	8.438	0.590	184	214	15	24600-1714	26	7.313	8.438	0.563	186	214	14
25003-6377	23	7.250	8.500	0.500	184	216	13	25003-0953	23	7.375	8.250	0.438	187	210	11
24060-6377	61	7.250	8.500	0.500	184	216	13	24600-6182	26	7.375	8.375	0.437	187	213	11
25003-3522	23	7.250	8.500	0.625	184	216	16	25003-6182	23	7.375	8.375	0.438	187	213	11
25010-3522	23	7.250	8.500	0.625	184	216	16	25003-4921	23	7.375	8.375	0.500	187	213	13
25006-3522	23	7.250	8.500	0.625	184	216	16	25003-3528	23	7.375	8.375	0.625	187	213	16
24626-3522	26	7.250	8.500	0.625	184	216	16	21086-3528	53	7.375	8.375	0.625	187	213	16
24627-3522	26	7.250	8.500	0.625	184	216	16	21095-3528	53	7.375	8.375	0.625	187	213	16
24600-3522	26	7.250	8.500	0.625	184	216	16	21699-3528	53	7.375	8.375	0.625	187	213	16
24610-3522	26	7.250	8.500	0.625	184	216	16	21003-3528	58	7.375	8.375	0.625	187	213	16
24631-3522	26	7.250	8.500	0.625	184	216	16	29519-3528	1G	7.375	8.375	0.625	187	213	16
21086-3522	53	7.250	8.500	0.625	184	216	16	29619-3528	GD	7.375	8.375	0.625	187	213	16
21699-3522	53	7.250	8.500	0.625	184	216	16	26588-9126	88	7.375	8.375	0.637	187	213	16
21095-3522	53	7.250	8.500	0.625	184	216	16	26088-9126	88	7.375	8.375	0.637	187	213	16
21702-3522	62	7.250	8.500	0.625	184	216	16	25003-1308	23	7.375	8.500	0.500	187	216	13
26180-3522	87NS	7.250	8.500	0.625	184	216	16	25003-3530	23	7.375	8.500	0.625	187	216	16
26186-3522	88NS	7.250	8.500	0.625	184	216	16	21086-3530	53	7.375	8.500	0.625	187	216	16
26188-3522	88NS	7.250	8.500	0.625	184	216	16	21699-3530	53	7.375	8.500	0.625	187	216	16
26086-3522	88	7.250	8.500	0.625	184	216	16	25003-3532	23	7.375	8.625	0.625	187	219	16
29602-3531	GD	7.250	8.500	0.700	184	216	18	25006-3532	23	7.375	8.625	0.625	187	219	16
25003-3523	23	7.250	8.500	0.750	184	216	19	24612-1327	26	7.375	8.625	0.625	187	219	16
25004-3523	23	7.250	8.500	0.750	184	216	19	21086-3532	53	7.375	8.625	0.625	187	219	16
24715-3531	59	7.250	8.500	0.750	184	216	19	25003-3533	23	7.375	8.625	0.750	187	219	19
25003-3524	23	7.250	8.625	0.625	184	219	16	29502-5746	1G	7.375	8.625	0.750	187	219	19
21086-3524	53	7.250	8.625	0.625	184	219	16	21086-3534	53	7.375	8.750	0.625	187	222	16
25003-3525	23	7.250	8.625	0.750	184	219	19	25003-3536	23	7.375	8.875	0.625	187	225	16
25003-1868	23	7.250	8.703	0.609	184	221	15	21096-3536	53	7.375	8.875	0.625	187	225	16
25003-6251	23	7.250	8.750	0.500	184	222	13	21086-3536	53	7.375	8.875	0.625	187	225	16
25003-3526	23	7.250	8.750	0.625	184	222	16	21699-3536	53	7.375	8.875	0.625	187	225	16
25006-3526	23	7.250	8.750	0.625	184	222	16	25003-3537	23	7.375	8.875	0.750	187	225	19
21087-3526	53	7.250	8.750	0.625	184	222	16	25006-3537	23	7.375	8.875	0.750	187	225	19
21086-3526	53	7.250	8.750	0.625	184	222	16	25004-3537	23	7.375	8.875	0.750	187	225	19
21699-3526	53	7.250	8.750	0.625	184	222	16	25003-3538	23	7.375	9.000	0.625	187	229	16
24715-1239	59	7.250	8.750	0.625	184	222	16	21086-3538	53	7.375	9.000	0.625	187	229	16
24700-1239	59	7.250	8.750	0.625	184	222	16	21086-3540	53	7.375	9.125	0.625	187	232	16

All dimensions are in inches. Preferred sizes are indicated with **bold** type face.

Sizes listed are for standard nitrile elements, except Models 25 and 62 which have PTFE elements. Other material available on inquiry only.



## Oil Seals by Model Number

Product Code	Model	Inches			MM			Product Code	Model	Inches			MM		
		ID	OD	Width	ID	OD	Width			ID	OD	Width	ID	OD	Width
25001-3541	21	7.375	9.125	0.750	187	232	19	24627-2043	26	7.480	8.661	0.591	190	220	15
21086-3542	53	7.375	9.250	0.625	187	235	16	21096-8049	53	7.480	8.661	0.591	190	220	15
24626-2145	26	7.401	8.582	0.590	188	218	15	26058-8049	57	7.480	8.661	0.591	190	220	15
24750-5626	59G1	7.402	8.465	0.630	188	215	16	24060-8049	61	7.480	8.661	0.591	190	220	15
24752-5626	59G1	7.402	8.465	0.630	188	215	16	25006-2866	23	7.480	8.677	0.500	190	220	13
22502-2164	53G1	7.402	8.465	0.755	188	215	19	24629-1036	26R1	7.480	8.858	0.630	190	225	16
24600-2145	26	7.402	8.583	0.591	188	218	15	24620-1036	26R1	7.480	8.858	0.630	190	225	16
29516-7146	1G	7.437	8.945	1.139	189	227	29	24602-3911	26	7.480	8.858	0.630	190	225	16
24816-7111	EQUAL	7.437	8.945	1.375	189	227	35	24610-2043	26	7.481	8.662	0.591	190	220	15
25006-7847	23	7.438	8.438	0.500	189	214	13	25006-3911	23	7.481	8.859	0.630	190	225	16
25004-7847	23	7.438	8.438	0.500	189	214	13	21335-4227	143	7.490	8.802	0.781	190	224	20
29502-6110	1G	7.438	8.438	0.750	189	214	19	25003-8252	23	7.500	8.375	0.500	191	213	13
25003-1965	23	7.438	8.500	0.500	189	216	13	25009-8252	23	7.500	8.375	0.500	191	213	13
25003-7443	23	7.438	8.500	0.625	189	216	16	21086-5115	53	7.500	8.464	0.625	191	215	16
25006-7443	23	7.438	8.500	0.625	189	216	16	25001-6378	21	7.500	8.500	0.500	191	216	13
25003-9846	23	7.438	8.688	0.625	189	221	16	25003-6378	23	7.500	8.500	0.500	191	216	13
25003-9792	23	7.438	8.938	0.750	189	227	19	25006-6378	23	7.500	8.500	0.500	191	216	13
24822-5142	EQUAL	7.438	9.000	0.625	189	229	16	25004-6378	23	7.500	8.500	0.500	191	216	13
24620-3923	26R1	7.441	8.858	0.630	189	225	16	24626-6378	26	7.500	8.500	0.500	191	216	13
24600-1716	26	7.441	9.875	0.512	189	251	13	24612-6378	26	7.500	8.500	0.500	191	216	13
24700-5324	59	7.468	8.468	0.688	190	215	17	25003-3544	23	7.500	8.500	0.625	191	216	16
24802-3802	EQUAL	7.469	8.469	0.625	190	215	16	25006-3544	23	7.500	8.500	0.625	191	216	16
24637-4960	26	7.480	8.346	.472	190	212	12	24626-3544	26	7.500	8.500	0.625	191	216	16
25003-2581	23	7.480	8.465	0.500	190	215	13	24600-3544	26	7.500	8.500	0.625	191	216	16
25003-2679	23	7.480	8.480	0.500	190	215	13	24610-3544	26	7.500	8.500	0.625	191	216	16
29504-5459	1G	7.480	8.480	0.750	190	215	19	22500-3544	53G1	7.500	8.500	0.625	191	216	16
25003-0504	23	7.480	8.661	0.472	190	220	12	21096-3544	53	7.500	8.500	0.625	191	216	16
25003-5333	23	7.480	8.661	0.492	190	220	12	21087-3544	53	7.500	8.500	0.625	191	216	16
24612-2043	26	7.480	8.661	0.591	190	220	15	21597-3544	53	7.500	8.500	0.625	191	216	16
21086-8049	53	7.480	8.661	0.591	190	220	15	21086-3544	53	7.500	8.500	0.625	191	216	16
21699-8049	53	7.480	8.661	0.591	190	220	15	21091-3544	53	7.500	8.500	0.625	191	216	16
24700-2043	59	7.480	8.661	0.591	190	220	15	21095-3544	53	7.500	8.500	0.625	191	216	16
24822-4686	EQUAL	7.480	8.661	0.625	190	220	16	21699-3544	53	7.500	8.500	0.625	191	216	16
25003-1379	23	7.480	8.661	0.630	190	220	16	24715-3544	59	7.500	8.500	0.625	191	216	16
29500-4756	1G	7.480	8.661	0.750	190	220	19	24700-3544	59	7.500	8.500	0.625	191	216	16
29502-4756	1G	7.480	8.661	0.750	190	220	19	21702-3544	62	7.500	8.500	0.625	191	216	16
25003-2866	23	7.480	8.677	0.500	190	220	13	21432-3545	142	7.500	8.500	0.750	191	216	19
25003-1690	23	7.480	8.729	0.625	190	222	16	22501-3545	53G1	7.500	8.500	0.750	191	216	19
26060-3911	57	7.480	8.858	0.630	190	225	16	29502-3803	1G	7.500	8.500	0.750	191	216	19
25003-3911	23	7.480	8.859	0.629	190	225	16	22537-8384	53R1	7.500	8.500	1.094	191	216	28
24610-3911	26	7.480	8.859	0.630	190	225	16	22627-8384	53R2	7.500	8.500	1.094	191	216	28
26058-3911	57	7.480	8.859	0.630	190	225	16	25003-3546	23	7.500	8.625	0.625	191	219	16
26057-3911	57	7.480	8.859	0.630	190	225	16	21086-3546	53	7.500	8.625	0.625	191	219	16
25006-1316	23	7.480	8.980	0.750	190	228	19	21699-3546	53	7.500	8.625	0.625	191	219	16
24782-4030	59	7.480	9.055	0.591	190	230	15	25135-1525	23	7.500	8.682	0.591	191	221	15
24783-4030	59	7.480	9.055	0.591	190	230	15	25003-7180	23	7.500	8.750	0.500	191	222	13
25003-1214	23	7.480	9.055	0.630	190	230	16	25006-3548	23	7.500	8.750	0.625	191	222	16
25006-1214	23	7.480	9.055	0.630	190	230	16	25003-3548	23	7.500	8.750	0.625	191	222	16
24612-2099	26	7.480	9.055	0.630	190	230	16	24626-3548	26	7.500	8.750	0.625	191	222	16
24700-2099	59	7.480	9.055	0.630	190	230	16	24610-3548	26	7.500	8.750	0.625	191	222	16
24610-5286	26	7.480	9.055	0.787	190	230	20	24612-3548	26	7.500	8.750	0.625	191	222	16
24600-3758	26	7.480	9.250	0.630	190	235	16	21096-3548	53	7.500	8.750	0.625	191	222	16
25006-1290	23	7.480	8.425	0.472	190	214	12	21086-3548	53	7.500	8.750	0.625	191	222	16
24626-4997	26	7.480	8.465	0.630	190	215	16	24715-3548	59	7.500	8.750	0.625	191	222	16
24600-4997	26	7.480	8.465	0.630	190	215	16	24700-3548	59	7.500	8.750	0.625	191	222	16
25003-8049	23	7.480	8.661	0.591	190	220	15	29602-5992	6D	7.500	8.750	0.700	191	222	18

All dimensions are in inches. Preferred sizes are indicated with **bold** type face. Sizes listed are for standard nitrile elements, except Models 25 and 62 which have PTFE elements. Other material available on inquiry only.

## Oil Seals by Model Number

Product Code	Model	Inches			MM			Product Code	Model	Inches			MM		
		ID	OD	Width	ID	OD	Width			ID	OD	Width	ID	OD	Width
29502-5992	IG	7.500	8.750	0.750	191	222	19	25003-2106	23	7.625	8.500	0.515	194	216	13
25003-4889	23	7.500	8.875	0.500	191	225	13	25003-7367	23	7.625	8.625	0.500	194	219	13
21086-3550	53	7.500	8.875	0.625	191	225	16	25006-7367	23	7.625	8.625	0.500	194	219	13
25003-6773	23	7.500	9.000	0.500	191	229	13	24602-7367	26	7.625	8.625	0.500	194	219	13
25006-6773	23	7.500	9.000	0.500	191	229	13	25003-3558	23	7.625	8.625	0.625	194	219	16
25005-6773	24	7.500	9.000	0.500	191	229	13	21096-3558	53	7.625	8.625	0.625	194	219	16
24610-6773	26	7.500	9.000	0.500	191	229	13	21087-3558	53	7.625	8.625	0.625	194	219	16
25003-3552	23	7.500	9.000	0.625	191	229	16	21086-3558	53	7.625	8.625	0.625	194	219	16
25006-3552	23	7.500	9.000	0.625	191	229	16	21699-3558	53	7.625	8.625	0.625	194	219	16
25058-3552	25	7.500	9.000	0.625	191	229	16	24715-4823	59	7.625	8.625	0.625	194	219	16
24600-3552	26	7.500	9.000	0.625	191	229	16	21702-3558	62	7.625	8.625	0.625	194	219	16
21086-3552	53	7.500	9.000	0.625	191	229	16	29604-7282	GD	7.625	8.625	0.700	194	219	18
21699-3552	53	7.500	9.000	0.625	191	229	16	29500-7282	IG	7.625	8.625	0.750	194	219	19
24715-3552	59	7.500	9.000	0.625	191	229	16	21086-3560	53	7.625	8.750	0.625	194	222	16
24700-3552	59	7.500	9.000	0.625	191	229	16	24700-2992	59	7.625	8.750	0.625	194	222	16
21702-3552	62	7.500	9.000	0.625	191	229	16	25003-3562	23	7.625	8.875	0.625	194	225	16
29519-3552	IG	7.500	9.000	0.625	191	229	16	21086-3562	53	7.625	8.875	0.625	194	225	16
24802-3552	EQUAL	7.500	9.000	0.625	191	229	16	21333-2190	143	7.625	8.937	0.781	194	227	20
24821-3552	EQUAL	7.500	9.000	0.625	191	229	16	21334-2190	143	7.625	8.937	0.781	194	227	20
24822-3552	EQUAL	7.500	9.000	0.625	191	229	16	29516-7202	IG	7.625	8.945	1.335	194	227	34
29604-3553	GD	7.500	9.000	0.700	191	229	18	25003-3564	23	7.625	9.000	0.625	194	229	16
22987-9584	53F1	7.500	9.000	0.719	191	229	18	25006-3564	23	7.625	9.000	0.625	194	229	16
25003-3553	23	7.500	9.000	0.750	191	229	19	25004-3564	23	7.625	9.000	0.625	194	229	16
25006-3553	23	7.500	9.000	0.750	191	229	19	21086-3564	53	7.625	9.000	0.625	194	229	16
25004-3553	23	7.500	9.000	0.750	191	229	19	25003-3566	23	7.625	9.125	0.625	194	232	16
24627-3553	26	7.500	9.000	0.750	191	229	19	25006-3566	23	7.625	9.125	0.625	194	232	16
24600-3553	26	7.500	9.000	0.750	191	229	19	25004-3566	23	7.625	9.125	0.625	194	232	16
21087-3553	53	7.500	9.000	0.750	191	229	19	24600-3566	26	7.625	9.125	0.625	194	232	16
21086-3553	53	7.500	9.000	0.750	191	229	19	24610-3566	26	7.625	9.125	0.625	194	232	16
29500-3553	IG	7.500	9.000	0.750	191	229	19	21086-3566	53	7.625	9.125	0.625	194	232	16
29502-3553	IG	7.500	9.000	0.750	191	229	19	21699-3566	53	7.625	9.125	0.625	194	232	16
22987-7233	53F1	7.500	9.000	0.844	191	229	21	26180-3566	87NS	7.625	9.125	0.625	194	232	16
24750-5418	59G1	7.500	9.000	0.937	191	229	24	26081-3566	87	7.625	9.125	0.625	194	232	16
22537-6564	53R1	7.500	9.000	1.344	191	229	34	25003-3567	23	7.625	9.125	0.750	194	232	19
25003-3463	23	7.500	9.008	0.750	191	229	19	21086-3567	53	7.625	9.125	0.750	194	232	19
25003-3554	23	7.500	9.125	0.625	191	232	16	25003-2614	23	7.625	9.188	0.625	194	233	16
21086-3554	53	7.500	9.125	0.625	191	232	16	21086-3568	53	7.625	9.250	0.625	194	235	16
21699-3554	53	7.500	9.125	0.625	191	232	16	25003-7320	23	7.667	9.055	0.591	195	230	15
21086-3555	53	7.500	9.125	0.750	191	232	19	24700-2183	59	7.677	9.055	0.591	195	230	15
25001-3556	21	7.500	9.250	0.625	191	235	16	25003-3974	23	7.677	9.252	0.625	195	235	16
21086-3556	53	7.500	9.250	0.625	191	235	16	24822-5083	EQUAL	7.680	8.680	0.750	195	220	19
21699-3556	53	7.500	9.250	0.625	191	235	16	25003-2517	23	7.687	8.687	0.500	195	221	13
25001-3557	21	7.500	9.250	0.750	191	235	19	25003-9340	23	7.688	9.188	0.750	195	233	19
22987-5234	53F1	7.500	9.250	0.938	191	235	24	25003-0980	23	7.717	8.661	0.472	196	220	12
22627-6596	53R2	7.500	9.250	1.219	191	235	31	25001-7912	21	7.725	9.375	0.750	196	238	19
23708-6596	53R2	7.500	9.250	1.219	191	235	31	25135-1519	23	7.750	8.734	0.492	197	222	12
24600-3136	26-L	7.500	10.250	0.500	191	260	13	24626-6185	26	7.750	8.750	0.437	197	222	11
25003-9065	23	7.519	9.019	0.750	191	229	19	24600-6185	26	7.750	8.750	0.437	197	222	11
25003-5638	23	7.530	8.780	0.625	191	223	16	25003-6185	23	7.750	8.750	0.438	197	222	11
25003-3848	23	7.563	8.500	0.625	192	216	16	26088-6185	88	7.750	8.750	0.438	197	222	11
24610-6187	26	7.563	9.062	0.625	192	230	16	26588-6185	88	7.750	8.750	0.438	197	222	11
25003-5241	23	7.563	9.062	0.750	192	230	19	25003-6379	23	7.750	8.750	0.500	197	222	13
25003-5578	23	7.563	9.065	0.375	192	230	10	25144-6379	23	7.750	8.750	0.500	197	222	13
25003-2688	23	7.600	8.894	0.750	193	226	19	25006-6379	23	7.750	8.750	0.500	197	222	13
25003-3201	23	7.615	8.625	0.500	193	219	13	25004-6379	23	7.750	8.750	0.500	197	222	13
25003-9895	23	7.620	9.120	0.750	194	232	19	24715-0697	59	7.750	8.750	0.500	197	222	13

All dimensions are in inches. Preferred sizes are indicated with **bold** type face.

Sizes listed are for standard nitrile elements, except Models 25 and 62 which have PTFE elements. Other material available on inquiry only.

## Oil Seals by Model Number

Product Code	Model	Inches			MM			Product Code	Model	Inches			MM		
		ID	OD	Width	ID	OD	Width			ID	OD	Width	ID	OD	Width
25003-3570	23	7.750	8.750	0.625	197	222	16	29516-7190	1G	7.813	9.340	0.977	198	237	25
21096-3570	53	7.750	8.750	0.625	197	222	16	25001-0965	21	7.824	9.375	0.750	199	238	19
21087-3570	53	7.750	8.750	0.625	197	222	16	25003-3577	23	7.844	8.844	0.500	199	225	13
21086-3570	53	7.750	8.750	0.625	197	222	16	25003-4990	23	7.854	8.854	0.500	199	225	13
21095-3570	53	7.750	8.750	0.625	197	222	16	29519-6016	1G	7.874	8.874	0.625	200	225	16
21699-3570	53	7.750	8.750	0.625	197	222	16	29500-5158	1G	7.874	8.874	0.750	200	225	19
24715-1895	59	7.750	8.750	0.625	197	222	16	29502-5158	1G	7.874	8.874	0.750	200	225	19
29519-1895	1G	7.750	8.750	0.625	197	222	16	29504-5158	1G	7.874	8.874	0.750	200	225	19
24822-2978	EQUAL	7.750	8.750	0.750	197	222	19	25003-3037	23	7.874	9.055	0.472	200	230	12
22627-6954	53R2	7.750	8.750	1.156	197	222	29	24667-5155	26	7.874	9.055	0.492	200	230	12
25003-3217	23	7.750	8.813	0.500	197	224	13	24602-5155	26	7.874	9.055	0.492	200	230	12
21086-3572	53	7.750	8.875	0.625	197	225	16	21086-4834	53	7.874	9.055	0.500	200	230	13
25003-3573	23	7.750	8.875	0.750	197	225	19	24629-3914	26R1	7.874	9.055	0.551	200	230	14
25003-7744	23	7.750	8.938	0.625	197	227	16	24620-3914	26R1	7.874	9.055	0.551	200	230	14
25003-6759	23	7.750	9.000	0.500	197	229	13	24626-3914	26	7.874	9.055	0.551	200	230	14
25003-3574	23	7.750	9.000	0.625	197	229	16	24600-3914	26	7.874	9.055	0.551	200	230	14
25004-3574	23	7.750	9.000	0.625	197	229	16	24608-7388	26R1	7.874	9.055	0.590	200	230	15
24627-1721	26	7.750	9.000	0.625	197	229	16	24602-7388	26	7.874	9.055	0.591	200	230	15
24610-1721	26	7.750	9.000	0.625	197	229	16	21087-7388	53	7.874	9.055	0.591	200	230	15
21086-3574	53	7.750	9.000	0.625	197	229	16	24782-7388	59	7.874	9.055	0.591	200	230	15
21684-3574	53	7.750	9.000	0.625	197	229	16	24064-7388	61	7.874	9.055	0.591	200	230	15
21699-3574	53	7.750	9.000	0.625	197	229	16	24060-7388	61	7.874	9.055	0.591	200	230	15
25003-2391	23	7.750	9.000	0.750	197	229	19	29619-7334	GD	7.874	9.055	0.625	200	230	16
21333-3443	143	7.750	9.062	0.781	197	230	20	29502-3301	1G	7.874	9.055	0.750	200	230	19
25003-3576	23	7.750	9.125	0.625	197	232	16	25006-1208	23	7.874	9.252	0.630	200	235	16
21086-3576	53	7.750	9.125	0.625	197	232	16	25003-1014	23	7.874	9.370	0.748	200	238	19
29604-6871	GD	7.750	9.247	0.700	197	235	18	25003-2500	23	7.874	9.374	0.752	200	238	19
24610-5390	26	7.750	9.250	0.500	197	235	13	25003-8420	23	7.874	9.448	0.629	200	240	16
25003-3578	23	7.750	9.250	0.625	197	235	16	25010-8420	23	7.874	9.448	0.629	200	240	16
24600-3578	26	7.750	9.250	0.625	197	235	16	25048-3043	25	7.874	9.449	0.512	200	240	13
21096-3578	53	7.750	9.250	0.625	197	235	16	24822-5105	EQUAL	7.874	9.449	0.625	200	240	16
21086-3578	53	7.750	9.250	0.625	197	235	16	24629-3916	26R1	7.874	9.449	0.787	200	240	20
21095-3578	53	7.750	9.250	0.625	197	235	16	24620-3916	26R1	7.874	9.449	0.787	200	240	20
24715-3578	59	7.750	9.250	0.625	197	235	16	24629-7388	26R1	7.874	9.055	0.591	200	230	15
24700-3578	59	7.750	9.250	0.625	197	235	16	24620-7388	26R1	7.874	9.055	0.591	200	230	15
21702-3578	62	7.750	9.250	0.625	197	235	16	24628-7388	26R1	7.874	9.055	0.591	200	230	15
24822-3578	EQUAL	7.750	9.250	0.625	197	235	16	24610-7388	26	7.874	9.055	0.591	200	230	15
25003-3579	23	7.750	9.250	0.750	197	235	19	21096-7388	53	7.874	9.055	0.591	200	230	15
21086-3579	53	7.750	9.250	0.750	197	235	19	24715-7388	59	7.874	9.055	0.591	200	230	15
22987-7241	53F1	7.750	9.250	0.844	197	235	21	24715-3908	59	7.874	9.252	0.630	200	235	16
22627-7358	53R2	7.750	9.250	0.875	197	235	22	25010-6926	23	7.874	9.291	0.748	200	236	19
24635-3136	26NS-L	7.750	10.250	0.500	197	260	13	25003-6926	23	7.874	9.291	0.748	200	236	19
29502-4739	1G	7.750	10.250	0.750	197	260	19	24626-3916	26	7.874	9.449	0.787	200	240	20
25003-4833	23	7.760	8.875	0.500	197	225	13	24600-3916	26	7.874	9.449	0.787	200	240	20
25003-1152	23	7.800	8.800	0.500	198	224	13	24637-4956	26	7.875	8.740	0.472	200	222	12
25003-2156	23	7.812	9.250	0.500	198	235	13	25003-4860	23	7.875	8.816	0.500	200	224	13
24715-5407	59	7.812	10.062	1.000	198	256	25	25003-5605	23	7.875	8.875	0.375	200	225	10
25003-3581	23	7.813	8.813	0.438	198	224	11	25003-6492	23	7.875	8.875	0.500	200	225	13
25003-8578	23	7.813	8.813	0.500	198	224	13	25006-6492	23	7.875	8.875	0.500	200	225	13
25006-8578	23	7.813	8.813	0.500	198	224	13	25003-3580	23	7.875	8.875	0.625	200	225	16
25004-8578	23	7.813	8.813	0.500	198	224	13	21086-3580	53	7.875	8.875	0.625	200	225	16
24612-0699	26	7.813	8.813	0.500	198	224	13	21527-3580	66	7.875	8.875	0.625	200	225	16
25003-1288	23	7.813	9.000	0.625	198	229	16	21432-3509	142	7.875	8.875	0.750	200	225	19
25003-9861	23	7.813	9.062	0.625	198	230	16	25054-5789	23	7.875	8.938	0.500	200	227	13
25004-9861	23	7.813	9.062	0.625	198	230	16	25003-5789	23	7.875	8.938	0.500	200	227	13
25003-6016	23	7.813	9.313	0.750	198	237	19	24600-3811	26	7.875	9.000	0.438	200	229	11

All dimensions are in inches. Preferred sizes are indicated with **bold** type face. Sizes listed are for standard nitrile elements, except Models 25 and 62 which have PTFE elements. Other material available on inquiry only.

## Oil Seals by Model Number

Product Code	Model	Inches			MM			Product Code	Model	Inches			MM		
		ID	OD	Width	ID	OD	Width			ID	OD	Width	ID	OD	Width
25003-6844	23	7.875	9.000	0.500	200	229	13	25003-2575	23	7.937	9.250	0.625	202	235	16
25004-6844	23	7.875	9.000	0.500	200	229	13	25003-4763	23	7.938	8.875	0.500	202	225	13
21086-3582	53	7.875	9.000	0.625	200	229	16	25003-7661	23	7.938	8.938	0.500	202	227	13
21699-3582	53	7.875	9.000	0.625	200	229	16	25004-7661	23	7.938	8.938	0.500	202	227	13
25010-5337	23	7.875	9.055	0.492	200	230	12	29519-6186	IG	7.938	8.938	0.625	202	227	16
25003-5337	23	7.875	9.055	0.492	200	230	12	21432-4463	142	7.938	8.938	0.750	202	227	19
25004-5337	23	7.875	9.055	0.492	200	230	12	25003-1061	23	7.938	9.000	0.500	202	229	13
21087-4834	53	7.875	9.055	0.500	200	230	13	25003-3590	23	7.938	9.125	0.625	202	232	16
25003-3914	23	7.875	9.055	0.551	200	230	14	21086-3590	53	7.938	9.125	0.625	202	232	16
25003-7388	23	7.875	9.055	0.591	200	230	15	22987-4978	53F1	7.938	9.125	0.969	202	232	25
25010-7388	23	7.875	9.055	0.591	200	230	15	25003-9955	23	7.938	9.188	0.625	202	233	16
21086-7388	53	7.875	9.055	0.591	200	230	15	25006-9955	23	7.938	9.188	0.625	202	233	16
21947-7388	53	7.875	9.055	0.591	200	230	15	29516-7196	IG	7.938	9.340	1.164	202	237	30
21003-7388	58	7.875	9.055	0.591	200	230	15	29616-7196	GD	7.938	9.340	1.164	202	237	30
24700-7388	59	7.875	9.055	0.591	200	230	15	24816-6161	EQUAL	7.938	9.340	1.229	202	237	31
24700-5317	59	7.875	9.055	0.630	200	230	16	25003-7133	23	7.938	9.438	0.750	202	240	19
22501-1101	53G1	7.875	9.055	0.688	200	230	17	25058-7133	25	7.938	9.438	0.750	202	240	19
25003-6000	23	7.875	9.056	0.375	200	230	10	25003-5685	23	7.960	9.460	0.625	202	240	16
25003-7108	23	7.875	9.125	0.375	200	232	10	25003-3930	23	7.971	9.000	0.375	202	229	10
25003-3584	23	7.875	9.125	0.625	200	232	16	25003-3966	23	7.984	9.000	0.375	203	229	10
21096-3584	53	7.875	9.125	0.625	200	232	16	29502-6095	IG	7.998	9.013	0.750	203	229	19
21086-3584	53	7.875	9.125	0.625	200	232	16	24600-1775	26	8.000	8.875	0.437	203	225	11
21335-3418	143	7.875	9.187	0.781	200	233	20	24602-1775	26	8.000	8.875	0.437	203	225	11
25003-3586	23	7.875	9.250	0.625	200	235	16	25003-9578	23	8.000	8.875	0.438	203	225	11
21086-3586	53	7.875	9.250	0.625	200	235	16	26193-9578	76	8.000	8.875	0.438	203	225	11
21699-3586	53	7.875	9.250	0.625	200	235	16	25003-4822	23	8.000	9.000	0.438	203	229	11
25010-3587	23	7.875	9.250	0.750	200	235	19	25006-4822	23	8.000	9.000	0.438	203	229	11
25003-3587	23	7.875	9.250	0.750	200	235	19	25004-4822	23	8.000	9.000	0.438	203	229	11
24600-3908	26	7.875	9.252	0.630	200	235	16	25010-6380	23	8.000	9.000	0.500	203	229	13
24610-6792	26	7.875	9.375	0.500	200	238	13	25003-6380	23	8.000	9.000	0.500	203	229	13
25010-3588	23	7.875	9.375	0.625	200	238	16	25006-6380	23	8.000	9.000	0.500	203	229	13
25003-3588	23	7.875	9.375	0.625	200	238	16	25005-6380	24	8.000	9.000	0.500	203	229	13
25006-3588	23	7.875	9.375	0.625	200	238	16	25058-6380	25	8.000	9.000	0.500	203	229	13
21096-3588	53	7.875	9.375	0.625	200	238	16	25059-6380	25	8.000	9.000	0.500	203	229	13
21086-3588	53	7.875	9.375	0.625	200	238	16	25048-6380	25	8.000	9.000	0.500	203	229	13
21699-3588	53	7.875	9.375	0.625	200	238	16	24801-0702	EQUAL	8.000	9.000	0.500	203	229	13
24715-3588	59	7.875	9.375	0.625	200	238	16	24821-0702	EQUAL	8.000	9.000	0.500	203	229	13
24700-3588	59	7.875	9.375	0.625	200	238	16	25003-3592	23	8.000	9.000	0.625	203	229	16
21527-3588	66	7.875	9.375	0.625	200	238	16	24600-3592	26	8.000	9.000	0.625	203	229	16
24801-3588	EQUAL	7.875	9.375	0.625	200	238	16	24610-3592	26	8.000	9.000	0.625	203	229	16
21238-9176	64	7.875	9.375	0.688	200	238	17	21699-3592	53	8.000	9.000	0.625	203	229	16
21852-9176	64	7.875	9.375	0.688	200	238	17	21096-3592	53	8.000	9.000	0.625	203	229	16
25003-3589	23	7.875	9.375	0.750	200	238	19	21086-3592	53	8.000	9.000	0.625	203	229	16
24600-3589	26	7.875	9.375	0.750	200	238	19	21095-3592	53	8.000	9.000	0.625	203	229	16
24610-3589	26	7.875	9.375	0.750	200	238	19	21947-3592	53	8.000	9.000	0.625	203	229	16
21086-3589	53	7.875	9.375	0.750	200	238	19	29519-3592	IG	8.000	9.000	0.625	203	229	16
29500-3589	IG	7.875	9.375	0.750	200	238	19	24821-3592	EQUAL	8.000	9.000	0.625	203	229	16
22627-5932	53R2	7.875	9.375	0.969	200	238	25	29602-5474	GD	8.000	9.000	0.700	203	229	18
25003-5372	23	7.875	9.448	0.618	200	240	16	21432-3593	142	8.000	9.000	0.750	203	229	19
25010-5372	23	7.875	9.448	0.618	200	240	16	21443-3593	142	8.000	9.000	0.750	203	229	19
24638-8420	26	7.875	9.449	0.630	200	240	16	21086-3593	53	8.000	9.000	0.750	203	229	19
25003-1107	23	7.875	9.500	0.629	200	241	16	21699-3593	53	8.000	9.000	0.750	203	229	19
25001-9835	21	7.875	9.500	0.750	200	241	19	22627-9165	53R2	8.000	9.000	0.969	203	229	25
25001-6973	21	7.875	9.875	0.625	200	251	16	22537-8751	53R1	8.000	9.000	1.156	203	229	29
25003-6973	23	7.875	9.875	0.625	200	251	16	24627-5580	26	8.000	9.055	0.630	203	230	16
25003-1949	23	7.879	8.859	0.591	200	225	15	24610-5580	26	8.000	9.055	0.630	203	230	16

All dimensions are in inches. Preferred sizes are indicated with **bold** type face.

Sizes listed are for standard nitrile elements, except Models 25 and 62 which have PTFE elements. Other material available on inquiry only.

## Oil Seals by Model Number

Product Code	Model	Inches			MM			Product Code	Model	Inches			MM		
		ID	OD	Width	ID	OD	Width			ID	OD	Width	ID	OD	Width
25003-7577	23	8.000	9.125	0.500	203	232	13	24610-3601	26	8.000	9.500	0.750	203	241	19
25003-3594	23	8.000	9.125	0.625	203	232	16	24612-3601	26	8.000	9.500	0.750	203	241	19
24600-3594	26	8.000	9.125	0.625	203	232	16	21086-3601	53	8.000	9.500	0.750	203	241	19
21086-3594	53	8.000	9.125	0.625	203	232	16	29502-3601	1G	8.000	9.500	0.750	203	241	19
25003-3595	23	8.000	9.125	0.750	203	232	19	22987-5260	53F1	8.000	9.500	0.969	203	241	25
25003-3199	23	8.000	9.250	0.437	203	235	11	22537-5260	53R1	8.000	9.500	0.969	203	241	25
25003-6510	23	8.000	9.250	0.500	203	235	13	21086-6381	53	8.000	9.625	0.750	203	244	19
25003-3596	23	8.000	9.250	0.625	203	235	16	21086-3922	53	8.000	9.750	0.750	203	248	19
25006-3596	23	8.000	9.250	0.625	203	235	16	22897-7370	53T2	8.000	9.750	1.406	203	248	36
25004-3596	23	8.000	9.250	0.625	203	235	16	25001-3003	21	8.000	10.000	0.625	203	254	16
24626-3596	26	8.000	9.250	0.625	203	235	16	25008-3003	21	8.000	10.000	0.625	203	254	16
24627-3596	26	8.000	9.250	0.625	203	235	16	24700-0002	59	8.000	10.000	0.625	203	254	16
24610-3596	26	8.000	9.250	0.625	203	235	16	21702-3003	62	8.000	10.000	0.625	203	254	16
21096-3596	53	8.000	9.250	0.625	203	235	16	21096-3924	53	8.000	10.000	0.688	203	254	17
21086-3596	53	8.000	9.250	0.625	203	235	16	21087-3924	53	8.000	10.000	0.688	203	254	17
21095-3596	53	8.000	9.250	0.625	203	235	16	21086-3924	53	8.000	10.000	0.688	203	254	17
21699-3596	53	8.000	9.250	0.625	203	235	16	21477-3924	53	8.000	10.000	0.688	203	254	17
24715-3596	59	8.000	9.250	0.625	203	235	16	24702-3924	59	8.000	10.000	0.688	203	254	17
24700-3596	59	8.000	9.250	0.625	203	235	16	25001-3925	21	8.000	10.000	0.750	203	254	19
24801-3596	EQUAL	8.000	9.250	0.625	203	235	16	25008-3925	21	8.000	10.000	0.750	203	254	19
25003-3597	23	8.000	9.250	0.750	203	235	19	25003-3925	23	8.000	10.000	0.750	203	254	19
21086-3597	53	8.000	9.250	0.750	203	235	19	24627-3925	26-L	8.000	10.000	0.750	203	254	19
29502-9354	1G	8.000	9.250	0.750	203	235	19	24610-3925	26-L	8.000	10.000	0.750	203	254	19
22987-6661	53F1	8.000	9.250	0.840	203	235	21	21086-3925	53	8.000	10.000	0.750	203	254	19
22897-5883	53T2	8.000	9.250	1.000	203	235	25	24751-3925	59G1	8.000	10.000	0.750	203	254	19
25003-3598	23	8.000	9.375	0.625	203	238	16	24715-3925	59	8.000	10.000	0.750	203	254	19
24626-3598	26	8.000	9.375	0.625	203	238	16	24822-3925	EQUAL	8.000	10.000	0.750	203	254	19
24600-3598	26	8.000	9.375	0.625	203	238	16	25001-3926	21	8.000	10.000	0.813	203	254	21
21086-3598	53	8.000	9.375	0.625	203	238	16	24627-3602	26-L	8.000	10.000	1.000	203	254	25
25003-9184	23	8.000	9.438	0.500	203	240	13	21086-3602	53	8.000	10.000	1.000	203	254	25
25003-1770	23	8.000	9.450	0.625	203	240	16	22627-9970	53R2	8.000	10.000	1.375	203	254	35
25003-3408	23	8.000	9.500	0.375	203	241	10	29516-7378	1G	8.000	10.433	1.464	203	265	37
25003-7758	23	8.000	9.500	0.500	203	241	13	21140-9750	54-L	8.000	14.750	0.625	203	375	16
25005-7758	24	8.000	9.500	0.500	203	241	13	25003-9874	23	8.062	9.312	0.625	205	237	16
25003-3600	23	8.000	9.500	0.625	203	241	16	24600-5192	26	8.062	9.563	0.500	205	243	13
25006-3600	23	8.000	9.500	0.625	203	241	16	25003-8805	23	8.063	9.062	0.463	205	230	12
21096-3600	53	8.000	9.500	0.625	203	241	16	25003-4810	23	8.063	9.313	0.500	205	237	13
21087-3600	53	8.000	9.500	0.625	203	241	16	25003-5009	23	8.063	9.563	0.750	205	243	19
21086-3600	53	8.000	9.500	0.625	203	241	16	21702-3927	62	8.063	10.000	1.000	205	254	25
21095-3600	53	8.000	9.500	0.625	203	241	16	24715-0003	59	8.063	10.062	1.000	205	256	25
21699-3600	53	8.000	9.500	0.625	203	241	16	25003-5384	23	8.125	9.125	0.438	206	232	11
24060-3600	61	8.000	9.500	0.625	203	241	16	25003-8175	23	8.125	9.125	0.500	206	232	13
21702-3600	62	8.000	9.500	0.625	203	241	16	25006-8175	23	8.125	9.125	0.500	206	232	13
25003-3921	23	8.000	9.500	0.687	203	241	17	25003-7869	23	8.125	9.188	0.500	206	233	13
24610-3768	26	8.000	9.500	0.687	203	241	17	25135-4749	23	8.125	9.375	0.625	206	238	16
24700-3768	59	8.000	9.500	0.688	203	241	17	25003-3928	23	8.125	9.625	0.750	206	244	19
21702-3921	62	8.000	9.500	0.688	203	241	17	25001-2062	21	8.125	10.000	0.750	206	254	19
21852-3921	64	8.000	9.500	0.688	203	241	17	21086-3603	53	8.125	10.000	1.000	206	254	25
21242-3921	64	8.000	9.500	0.688	203	241	17	24700-0004	59	8.125	10.125	0.625	206	257	16
21247-3921	64	8.000	9.500	0.688	203	241	17	21086-3932	53	8.125	10.125	0.750	206	257	19
21773-3921	64	8.000	9.500	0.688	203	241	17	22500-3473	53G1	8.125	10.125	0.875	206	257	22
21238-3921	64	8.000	9.500	0.688	203	241	17	22897-7786	53T2	8.125	10.125	1.281	206	257	33
21243-3921	64	8.000	9.500	0.688	203	241	17	25003-8418	23	8.188	9.188	0.500	208	233	13
25003-3601	23	8.000	9.500	0.750	203	241	19	25003-8234	23	8.188	9.313	0.500	208	237	13
25006-3601	23	8.000	9.500	0.750	203	241	19	25003-9473	23	8.188	9.687	0.500	208	246	13
24627-3601	26	8.000	9.500	0.750	203	241	19	24626-2147	26	8.189	9.370	0.590	208	238	15

All dimensions are in inches. Preferred sizes are indicated with **bold** type face. Sizes listed are for standard nitrile elements, except Models 25 and 62 which have PTFE elements. Other material available on inquiry only.

## Oil Seals by Model Number

Product Code	Model	Inches			MM			Product Code	Model	Inches			MM		
		ID	OD	Width	ID	OD	Width			ID	OD	Width	ID	OD	Width
24600-2147	26	8.189	9.370	0.591	208	238	15	25003-7157	23	8.250	9.750	0.750	210	248	19
25003-2598	23	8.214	9.464	0.500	209	240	13	24700-7157	59	8.250	9.750	0.750	210	248	19
21432-1243	142	8.228	9.228	0.750	209	234	19	25018-2743	21	8.250	9.812	0.750	210	249	19
21443-1243	142	8.228	9.228	0.750	209	234	19	25018-2742	21	8.250	10.000	0.750	210	254	19
24822-5366	EQUAL	8.245	9.230	0.625	209	234	16	24715-0005	59	8.250	10.250	0.625	210	260	16
25003-6204	23	8.250	9.250	0.438	210	235	11	24700-0005	59	8.250	10.250	0.625	210	260	16
25003-6382	23	8.250	9.250	0.500	210	235	13	24707-0005	59	8.250	10.250	0.625	210	260	16
25006-6382	23	8.250	9.250	0.500	210	235	13	24626-1068	26-L	8.250	10.250	0.750	210	260	19
25004-6382	23	8.250	9.250	0.500	210	235	13	24627-1068	26-L	8.250	10.250	0.750	210	260	19
25058-6382	25	8.250	9.250	0.500	210	235	13	24600-1068	26-L	8.250	10.250	0.750	210	260	19
25003-3604	23	8.250	9.250	0.625	210	235	16	24610-1068	26-L	8.250	10.250	0.750	210	260	19
25006-3604	23	8.250	9.250	0.625	210	235	16	24700-1068	59	8.250	10.250	0.750	210	260	19
24600-3817	26	8.250	9.250	0.625	210	235	16	21247-4499	64	8.250	10.250	0.813	210	260	21
21096-3604	53	8.250	9.250	0.625	210	235	16	21238-4499	64	8.250	10.250	0.813	210	260	21
21086-3604	53	8.250	9.250	0.625	210	235	16	21852-4499	64	8.250	10.250	0.813	210	260	21
21091-3604	53	8.250	9.250	0.625	210	235	16	21243-4499	64	8.250	10.250	0.813	210	260	21
21095-3604	53	8.250	9.250	0.625	210	235	16	21086-3607	53	8.250	10.250	1.000	210	260	25
21699-3604	53	8.250	9.250	0.625	210	235	16	21699-3607	53	8.250	10.250	1.000	210	260	25
24700-3817	59	8.250	9.250	0.625	210	235	16	21095-3607	53	8.250	10.250	1.000	210	260	25
29531-3817	16	8.250	9.250	0.625	210	235	16	26080-2268	87	8.250	10.260	0.688	210	261	17
21432-4483	142	8.250	9.250	0.750	210	235	19	24700-0006	59	8.250	10.500	0.875	210	267	22
21443-4483	142	8.250	9.250	0.750	210	235	19	24700-0007	59	8.250	11.500	0.750	210	292	19
25003-4760	23	8.250	9.375	0.500	210	238	13	25003-5338	23	8.267	9.448	0.590	210	240	15
25004-4760	23	8.250	9.375	0.500	210	238	13	24629-5338	26R1	8.267	9.448	0.590	210	240	15
21086-3605	53	8.250	9.375	0.625	210	238	16	24627-5338	26	8.267	9.448	0.590	210	240	15
25003-8451	23	8.250	9.500	0.500	210	241	13	24610-5338	26	8.267	9.448	0.590	210	240	15
25004-8451	23	8.250	9.500	0.500	210	241	13	24600-5338	26	8.267	9.448	0.590	210	240	15
25009-3606	23	8.250	9.500	0.625	210	241	16	24620-5338	26R1	8.267	9.449	0.590	210	240	15
25010-3606	23	8.250	9.500	0.625	210	241	16	21096-7887	53	8.267	9.842	0.551	210	250	14
25003-3606	23	8.250	9.500	0.625	210	241	16	21086-7887	53	8.267	9.842	0.551	210	250	14
25006-3606	23	8.250	9.500	0.625	210	241	16	21095-7887	53	8.267	9.842	0.551	210	250	14
25004-3606	23	8.250	9.500	0.625	210	241	16	25002-5373	21	8.267	9.842	0.618	210	250	16
24608-3606	26R1	8.250	9.500	0.625	210	241	16	25001-9521	21	8.267	9.842	0.630	210	250	16
24600-3606	26	8.250	9.500	0.625	210	241	16	25008-9521	21	8.267	9.843	0.630	210	250	16
24610-3606	26	8.250	9.500	0.625	210	241	16	25006-2833	23	8.268	9.449	0.472	210	240	12
21096-3606	53	8.250	9.500	0.625	210	241	16	24626-5338	26	8.268	9.449	0.591	210	240	15
21087-3606	53	8.250	9.500	0.625	210	241	16	24612-5338	26	8.268	9.449	0.591	210	240	15
21597-3606	53	8.250	9.500	0.625	210	241	16	24716-3526	59	8.268	9.843	0.591	210	250	15
21086-3606	53	8.250	9.500	0.625	210	241	16	25001-5373	21	8.268	9.843	0.618	210	250	16
21095-3606	53	8.250	9.500	0.625	210	241	16	24637-4955	26	8.268	9.134	0.472	210	232	12
21684-3606	53	8.250	9.500	0.625	210	241	16	29504-5460	16	8.268	9.268	0.750	210	235	19
21699-3606	53	8.250	9.500	0.625	210	241	16	25003-2833	23	8.268	9.449	0.472	210	240	12
24700-3606	59	8.250	9.500	0.625	210	241	16	24612-2807	26	8.268	9.449	0.472	210	240	12
24060-3606	61	8.250	9.500	0.625	210	241	16	29502-6724	16	8.268	9.449	0.750	210	240	19
24060-9224	61	8.250	9.500	0.625	210	241	16	25003-3812	23	8.268	9.568	0.500	210	243	13
24841-3606	EQUAL	8.250	9.500	0.625	210	241	16	24612-2248	26	8.268	9.646	0.591	210	245	15
25003-3818	23	8.250	9.500	0.750	210	241	19	24600-5231	26	8.268	9.803	0.866	210	249	22
26180-3818	87NS	8.250	9.500	0.750	210	241	19	25003-5161	23	8.313	9.313	0.500	211	237	13
26186-3818	88NS	8.250	9.500	0.750	210	241	19	25003-9889	23	8.313	9.563	0.625	211	243	16
22987-8729	53F1	8.250	9.500	0.844	210	241	21	24839-7045	EQUAL	8.313	9.840	1.625	211	250	41
22897-4545	53T2	8.250	9.500	1.125	210	241	29	25003-9548	23	8.375	9.375	0.500	213	238	13
25003-2647	23	8.250	9.688	0.750	210	246	19	25003-7344	23	8.375	9.500	0.625	213	241	16
25003-6247	23	8.250	9.750	0.500	210	248	13	25003-8776	23	8.375	9.625	0.500	213	244	13
25005-6247	24	8.250	9.750	0.500	210	248	13	25003-4893	23	8.375	9.625	0.625	213	244	16
24610-3456	26	8.250	9.750	0.500	210	248	13	25003-3007	23	8.375	9.750	0.625	213	248	16
25003-6684	23	8.250	9.750	0.625	210	248	16	24700-0008	59	8.375	9.750	0.625	213	248	16

All dimensions are in inches. Preferred sizes are indicated with **bold** type face.

Sizes listed are for standard nitrile elements, except Models 25 and 62 which have PTFE elements. Other material available on inquiry only.

## Oil Seals by Model Number

Product Code	Model	Inches			MM			Product Code	Model	Inches			MM		
		ID	OD	Width	ID	OD	Width			ID	OD	Width	ID	OD	Width
25003-3608	23	8.375	9.750	0.750	213	248	19	24612-3934	26	8.500	9.500	0.500	216	241	13
21087-3608	53	8.375	9.750	0.750	213	248	19	24064-6383	61	8.500	9.500	0.500	216	241	13
21086-3608	53	8.375	9.750	0.750	213	248	19	26188-6383	88NS	8.500	9.500	0.500	216	241	13
21095-3608	53	8.375	9.750	0.750	213	248	19	26088-6383	88	8.500	9.500	0.500	216	241	13
24715-3631	59	8.375	9.750	0.750	213	248	19	25003-3935	23	8.500	9.500	0.625	216	241	16
24700-3631	59	8.375	9.750	0.750	213	248	19	25010-3935	23	8.500	9.500	0.625	216	241	16
21702-3608	62	8.375	9.750	0.750	213	248	19	24600-3935	26	8.500	9.500	0.625	216	241	16
22537-9618	53R1	8.375	9.750	1.156	213	248	29	21096-3935	53	8.500	9.500	0.625	216	241	16
25003-2727	23	8.375	9.875	0.375	213	251	10	21086-3935	53	8.500	9.500	0.625	216	241	16
25003-8452	23	8.375	9.875	0.500	213	251	13	21091-3935	53	8.500	9.500	0.625	216	241	16
25005-8452	24	8.375	9.875	0.500	213	251	13	21699-3935	53	8.500	9.500	0.625	216	241	16
25030-8452	24	8.375	9.875	0.500	213	251	13	24715-3935	59	8.500	9.500	0.625	216	241	16
25003-4799	23	8.375	9.875	0.625	213	251	16	24700-3935	59	8.500	9.500	0.625	216	241	16
25058-4799	25	8.375	9.875	0.625	213	251	16	24829-3935	EQUAL	8.500	9.500	0.625	216	241	16
24700-0009	59	8.375	9.875	0.625	213	251	16	22627-6969	53R2	8.500	9.500	0.969	216	241	25
25003-3933	23	8.375	9.875	0.688	213	251	17	22897-6969	53T2	8.500	9.500	0.969	216	241	25
24600-3933	26	8.375	9.875	0.688	213	251	17	22544-9299	53R1	8.500	9.500	1.094	216	241	28
21086-3933	53	8.375	9.875	0.688	213	251	17	22537-9299	53R1	8.500	9.500	1.094	216	241	28
21238-3933	64	8.375	9.875	0.688	213	251	17	22537-6140	53R1	8.500	9.500	1.313	216	241	33
25003-3934	23	8.375	9.875	0.750	213	251	19	22537-2955	53R1	8.500	9.500	1.375	216	241	35
21086-3934	53	8.375	9.875	0.750	213	251	19	25003-4922	23	8.500	9.750	0.500	216	248	13
26088-3934	88	8.375	9.875	0.750	213	251	19	21238-1705	64	8.500	9.750	0.563	216	248	14
22627-5918	53R2	8.375	9.875	1.156	213	251	29	25001-6384	21	8.500	9.750	0.625	216	248	16
29516-7220	1G	8.375	9.945	1.242	213	253	32	25003-6384	23	8.500	9.750	0.625	216	248	16
25003-3895	23	8.375	10.000	0.625	213	254	16	25006-6384	23	8.500	9.750	0.625	216	248	16
25001-9267	21	8.375	10.375	0.750	213	264	19	24627-6384	26	8.500	9.750	0.625	216	248	16
25003-9267	23	8.375	10.375	0.750	213	264	19	24600-6384	26	8.500	9.750	0.625	216	248	16
24700-0010	59	8.375	10.375	0.750	213	264	19	24610-6384	26	8.500	9.750	0.625	216	248	16
21086-3609	53	8.375	10.375	1.000	213	264	25	24602-6384	26	8.500	9.750	0.625	216	248	16
25003-5308	23	8.394	9.394	0.500	213	239	13	21238-6384	64	8.500	9.750	0.625	216	248	16
25003-1463	23	8.437	9.938	0.500	214	252	13	25003-9207	23	8.500	9.750	0.750	216	248	19
25003-1592	23	8.437	9.938	0.750	214	252	19	25004-9207	23	8.500	9.750	0.750	216	248	19
21477-4501	53	8.437	10.000	0.625	214	254	16	25058-9207	25	8.500	9.750	0.750	216	248	19
21086-4501	53	8.438	10.000	0.625	214	254	16	24600-1913	26	8.500	9.750	0.750	216	248	19
21530-4501	53	8.438	10.000	0.625	214	254	16	24610-1913	26	8.500	9.750	0.750	216	248	19
24700-4501	59	8.438	10.000	0.625	214	254	16	25003-8709	23	8.500	9.875	0.750	216	251	19
25003-5402	23	8.464	9.448	0.500	215	240	13	25003-8665	23	8.500	10.000	0.500	216	254	13
25003-5358	23	8.464	9.645	0.590	215	245	15	25006-8665	23	8.500	10.000	0.500	216	254	13
24612-6236	26	8.465	9.646	0.630	215	245	16	25004-8665	23	8.500	10.000	0.500	216	254	13
26058-2716	57	8.465	9.646	0.630	215	245	16	25005-8665	24	8.500	10.000	0.500	216	254	13
25003-2597	23	8.465	9.843	0.591	215	250	15	24627-3959	26-L	8.500	10.000	0.500	216	254	13
25003-1953	23	8.465	9.646	0.493	215	245	13	25003-4502	23	8.500	10.000	0.625	216	254	16
25003-0961	23	8.465	9.764	0.590	215	248	15	25058-4502	25	8.500	10.000	0.625	216	254	16
25284-0961	23	8.465	9.764	0.590	215	248	15	21096-4502	53	8.500	10.000	0.625	216	254	16
24715-5453	59	8.465	9.843	0.630	215	250	16	21086-4502	53	8.500	10.000	0.625	216	254	16
25003-0746	23	8.465	9.845	0.645	215	250	16	21699-4502	53	8.500	10.000	0.625	216	254	16
24821-3068	EQUAL	8.465	9.965	0.750	215	253	19	24715-0012	59	8.500	10.000	0.625	216	254	16
25003-8623	23	8.469	9.968	0.500	215	253	13	24717-0012	59	8.500	10.000	0.625	216	254	16
25003-8189	23	8.469	9.968	0.750	215	253	19	24703-0012	59	8.500	10.000	0.625	216	254	16
25003-5461	23	8.470	9.500	0.500	215	241	13	24700-0012	59	8.500	10.000	0.625	216	254	16
25003-8583	23	8.500	9.375	0.500	216	238	13	21702-4502	62	8.500	10.000	0.625	216	254	16
25001-6383	21	8.500	9.500	0.500	216	241	13	21238-8453	64	8.500	10.000	0.688	216	254	17
25009-6383	23	8.500	9.500	0.500	216	241	13	21852-8453	64	8.500	10.000	0.688	216	254	17
25010-6383	23	8.500	9.500	0.500	216	241	13	25001-3937	21	8.500	10.000	0.750	216	254	19
25006-6383	23	8.500	9.500	0.500	216	241	13	25010-3937	23	8.500	10.000	0.750	216	254	19
25004-6383	23	8.500	9.500	0.500	216	241	13	25003-3937	23	8.500	10.000	0.750	216	254	19

All dimensions are in inches. Preferred sizes are indicated with **bold** type face. Sizes listed are for standard nitrile elements, except Models 25 and 62 which have PTFE elements. Other material available on inquiry only.

## Oil Seals by Model Number

Product Code	Model	Inches			MM			Product Code	Model	Inches			MM		
		ID	OD	Width	ID	OD	Width			ID	OD	Width	ID	OD	Width
25006-3937	23	8.500	10.000	0.750	216	254	19	25003-3941	23	8.625	10.250	0.750	219	260	19
24622-3937	26R1-L	8.500	10.000	0.750	216	254	19	21096-3941	53	8.625	10.250	0.750	219	260	19
24600-3937	26-L	8.500	10.000	0.750	216	254	19	21086-3941	53	8.625	10.250	0.750	219	260	19
24610-3937	26-L	8.500	10.000	0.750	216	254	19	29500-5808	1G	8.625	10.250	0.750	219	260	19
24602-3937	26-L	8.500	10.000	0.750	216	254	19	24626-3828	26-L	8.625	10.500	0.500	219	267	13
21096-3937	53	8.500	10.000	0.750	216	254	19	24600-3828	26-L	8.625	10.500	0.500	219	267	13
21087-3937	53	8.500	10.000	0.750	216	254	19	25001-3943	21	8.625	10.500	0.750	219	267	19
21086-3937	53	8.500	10.000	0.750	216	254	19	21086-3943	53	8.625	10.500	0.750	219	267	19
21702-3937	62	8.500	10.000	0.750	216	254	19	21699-3943	53	8.625	10.500	0.750	219	267	19
22987-6760	53F1	8.500	10.000	1.000	216	254	25	24700-1741	59	8.625	10.500	0.750	219	267	19
22537-6760	53R1	8.500	10.000	1.000	216	254	25	22987-6520	53F1	8.625	10.500	1.000	219	267	25
25003-3117	23	8.500	10.062	0.750	216	256	19	24700-0017	59	8.625	10.625	0.625	219	270	16
25003-4727	23	8.500	10.250	0.750	216	260	19	25003-3611	23	8.625	10.625	0.750	219	270	19
25003-8223	23	8.500	10.375	0.625	216	264	16	24600-3611	26-L	8.625	10.625	0.750	219	270	19
25001-8560	21	8.500	10.500	0.500	216	267	13	24610-3611	26-L	8.625	10.625	0.750	219	270	19
25003-8560	23	8.500	10.500	0.500	216	267	13	21086-3611	53	8.625	10.625	0.750	219	270	19
25004-8560	23	8.500	10.500	0.500	216	267	13	25003-9203	23	8.625	10.625	0.813	219	270	21
25003-5916	23	8.500	10.500	0.625	216	267	16	21086-3945	53	8.625	10.625	1.000	219	270	25
25006-5916	23	8.500	10.500	0.625	216	267	16	21086-3612	53	8.625	10.750	1.000	219	273	25
24700-0013	59	8.500	10.500	0.625	216	267	16	25003-5598	23	8.661	9.661	0.500	220	245	13
25003-7101	23	8.500	10.500	0.750	216	267	19	25003-4757	23	8.661	9.842	0.512	220	250	13
24600-7101	26-L	8.500	10.500	0.750	216	267	19	25003-5357	23	8.661	9.842	0.590	220	250	15
24610-7101	26-L	8.500	10.500	0.750	216	267	19	25006-5357	23	8.661	9.842	0.590	220	250	15
21086-7101	53	8.500	10.500	0.750	216	267	19	24629-5357	26R1	8.661	9.842	0.590	220	250	15
25004-3938	23	8.500	10.500	0.813	216	267	21	24651-5357	26R1	8.661	9.842	0.590	220	250	15
25003-3938	23	8.500	10.500	0.813	216	267	21	24620-5357	26R1	8.661	9.842	0.590	220	250	15
21238-3938	64	8.500	10.500	0.813	216	267	21	24602-5357	26	8.661	9.842	0.590	220	250	15
21086-3610	53	8.500	10.500	1.000	216	267	25	24610-5357	26	8.661	9.842	0.590	220	250	15
21095-3610	53	8.500	10.500	1.000	216	267	25	21086-5357	53	8.661	9.842	0.590	220	250	15
22627-9414	53R2	8.500	10.500	1.250	216	267	32	24702-5357	59	8.661	9.842	0.590	220	250	15
22537-6770	53R1	8.500	10.500	1.313	216	267	33	21096-5357	53	8.661	9.842	0.591	220	250	15
21086-4587	53	8.500	10.625	0.750	216	270	19	24700-5357	59	8.661	9.842	0.594	220	250	15
25003-5684	23	8.530	9.780	0.625	217	248	16	25003-3942	23	8.661	9.842	0.630	220	250	16
21003-2490	58	8.540	9.750	0.625	217	248	16	29502-6034	1G	8.661	9.842	0.750	220	250	19
25003-0570	23	8.560	9.810	0.625	217	249	16	24743-5357	59	8.661	9.843	0.591	220	250	15
25003-0957	23	8.611	10.236	0.750	219	260	19	25003-2829	23	8.661	9.844	0.472	220	250	12
24627-5630	26	8.625	9.625	0.468	219	244	12	21702-5357	62	8.661	9.844	0.591	220	250	15
24626-3825	26	8.625	9.625	0.500	219	244	13	25003-9242	23	8.661	9.911	0.500	220	252	13
24600-3825	26	8.625	9.625	0.500	219	244	13	25010-9243	23	8.661	9.911	0.625	220	252	16
24627-5629	26	8.625	9.625	0.562	219	244	14	25003-9243	23	8.661	9.911	0.625	220	252	16
25003-9210	23	8.625	9.875	0.500	219	251	13	29519-5750	1G	8.661	9.912	0.625	220	252	16
25003-6570	23	8.625	9.875	0.625	219	251	16	21333-3299	143	8.661	9.973	0.781	220	253	20
24600-6570	26	8.625	9.875	0.625	219	251	16	24700-0020	59	8.661	10.228	0.625	220	260	16
24612-6570	26	8.625	9.875	0.625	219	251	16	25003-4042	23	8.661	10.236	0.551	220	260	14
25003-3286	23	8.625	10.000	0.625	219	254	16	24717-5294	59	8.661	10.236	0.562	220	260	14
24700-0015	59	8.625	10.125	0.625	219	257	16	25003-0891	23	8.661	10.236	0.591	220	260	15
24821-0015	EQUAL	8.625	10.125	0.625	219	257	16	24700-0019	59	8.661	10.236	0.625	220	260	16
21086-3939	53	8.625	10.125	0.688	219	257	17	25001-8606	21	8.661	10.236	0.630	220	260	16
21937-3939	64	8.625	10.125	0.688	219	257	17	25003-8606	23	8.661	10.236	0.630	220	260	16
21238-3939	64	8.625	10.125	0.688	219	257	17	26088-8606	88	8.661	10.236	0.630	220	260	16
21852-3939	64	8.625	10.125	0.688	219	257	17	25003-1392	23	8.661	10.236	0.787	220	260	20
21243-3939	64	8.625	10.125	0.688	219	257	17	25006-1392	23	8.661	10.236	0.787	220	260	20
25003-3940	23	8.625	10.125	0.750	219	257	19	24620-3944	26R1-L	8.661	10.236	0.866	220	260	22
21086-3940	53	8.625	10.125	0.750	219	257	19	24626-3944	26-L	8.661	10.236	0.866	220	260	22
24700-0016	59	8.625	10.250	0.625	219	260	16	24700-0021	59	8.661	10.819	0.950	220	275	24
21243-2736	64	8.625	10.250	0.688	219	260	17	29502-6470	1G	8.661	11.000	0.750	220	279	19

All dimensions are in inches. Preferred sizes are indicated with **bold** type face.

Sizes listed are for standard nitrile elements, except Models 25 and 62 which have PTFE elements. Other material available on inquiry only.



## Oil Seals by Model Number

Product Code	Model	Inches			MM			Product Code	Model	Inches			MM		
		ID	OD	Width	ID	OD	Width			ID	OD	Width	ID	OD	Width
25006-2829	23	8.661	9.843	0.472	220	250	12	25003-3948	23	8.750	10.375	0.750	222	264	19
24608-5357	26R1	8.661	9.843	0.591	220	250	15	21086-3948	53	8.750	10.375	0.750	222	264	19
24627-5357	26	8.661	9.843	0.591	220	250	15	25003-3949	23	8.750	10.500	0.750	222	267	19
24612-5357	26	8.661	9.843	0.591	220	250	15	25006-3949	23	8.750	10.500	0.750	222	267	19
24716-5357	59	8.661	9.843	0.591	220	250	15	24610-0023	26-L	8.750	10.500	0.750	222	267	19
29519-6848	IG	8.661	9.843	0.626	220	250	16	21086-3949	53	8.750	10.500	0.750	222	267	19
24600-3942	26	8.661	9.843	0.630	220	250	16	21699-3949	53	8.750	10.500	0.750	222	267	19
24602-3942	26	8.661	9.843	0.630	220	250	16	21095-3949	53	8.750	10.500	0.750	222	267	19
24610-6858	26-L	8.661	10.236	0.591	220	260	15	25003-1082	23	8.750	10.500	0.813	222	267	21
26081-1392	87	8.661	10.236	0.787	220	260	20	29519-6010	IG	8.750	10.625	0.625	222	270	16
26080-1392	87	8.661	10.236	0.787	220	260	20	24802-6010	EQUAL	8.750	10.625	0.625	222	270	16
24600-3944	26-L	8.661	10.236	0.866	220	260	22	24821-6010	EQUAL	8.750	10.625	0.625	222	270	16
25003-6210	23	8.687	9.938	0.750	221	252	19	21086-3950	53	8.750	10.625	0.750	222	270	19
25003-9146	23	8.688	9.688	0.500	221	246	13	24700-0024	59	8.750	10.625	0.750	222	270	19
25003-7804	23	8.688	9.938	0.625	221	252	16	25001-3951	21	8.750	10.750	0.750	222	273	19
25003-6827	23	8.750	9.750	0.500	222	248	13	25003-3951	23	8.750	10.750	0.750	222	273	19
25006-6827	23	8.750	9.750	0.500	222	248	13	25006-3951	23	8.750	10.750	0.750	222	273	19
25004-6827	23	8.750	9.750	0.500	222	248	13	24627-3951	26-L	8.750	10.750	0.750	222	273	19
24600-3829	26	8.750	9.750	0.563	222	248	14	24600-3951	26-L	8.750	10.750	0.750	222	273	19
29620-6902	GD	8.750	9.750	0.700	222	248	18	24610-3951	26-L	8.750	10.750	0.750	222	273	19
25003-1694	23	8.750	9.764	0.375	222	248	10	24612-3951	26-L	8.750	10.750	0.750	222	273	19
25003-5890	23	8.750	9.875	0.625	222	251	16	21086-3951	53	8.750	10.750	0.750	222	273	19
25003-9559	23	8.750	9.875	0.688	222	251	17	21702-3951	62	8.750	10.750	0.750	222	273	19
25003-5480	23	8.750	9.875	0.750	222	251	19	25003-3952	23	8.750	10.750	0.813	222	273	21
25003-2937	23	8.750	10.000	0.375	222	254	10	21238-3952	64	8.750	10.750	0.813	222	273	21
25003-4981	23	8.750	10.000	0.515	222	254	13	21086-3613	53	8.750	10.750	1.000	222	273	25
25006-6386	23	8.750	10.000	0.625	222	254	16	22537-8687	53R1	8.750	10.750	1.375	222	273	35
24608-6386	26R1-L	8.750	10.000	0.625	222	254	16	22627-8687	53R2	8.750	10.750	1.375	222	273	35
24626-6386	26-L	8.750	10.000	0.625	222	254	16	21238-2812	64	8.750	10.875	0.812	222	276	21
24600-6386	26-L	8.750	10.000	0.625	222	254	16	25003-5525	23	8.780	10.780	0.750	223	274	19
24610-6386	26-L	8.750	10.000	0.625	222	254	16	25003-6334	23	8.812	10.312	0.500	224	262	13
24627-6386	26-L	8.750	10.000	0.625	222	254	16	25003-6943	23	8.813	9.813	0.500	224	249	13
24612-6386	26-L	8.750	10.000	0.625	222	254	16	25010-0409	23	8.813	10.062	0.437	224	256	11
21096-6386	53	8.750	10.000	0.625	222	254	16	25003-3042	23	8.858	10.039	0.591	225	255	15
21086-6386	53	8.750	10.000	0.625	222	254	16	29619-6763	GD	8.858	10.039	0.625	225	255	16
24700-6386	59	8.750	10.000	0.625	222	254	16	25003-2247	23	8.858	10.433	0.630	225	265	16
26088-6386	88	8.750	10.000	0.625	222	254	16	24700-0025	59	8.858	11.016	0.906	225	280	23
25003-3206	23	8.750	10.000	0.750	222	254	19	25045-8481	23	8.859	9.842	0.492	225	250	12
22987-8182	53F1	8.750	10.000	1.000	222	254	25	25003-8481	23	8.859	9.842	0.492	225	250	12
29516-7201	IG	8.750	10.215	1.335	222	259	34	25006-8481	23	8.859	9.842	0.492	225	250	12
25003-6845	23	8.750	10.250	0.500	222	260	13	25003-4992	23	8.859	9.859	0.500	225	250	13
25003-8142	23	8.750	10.250	0.625	222	260	16	25003-5910	23	8.859	10.359	0.750	225	263	19
24700-0022	59	8.750	10.250	0.625	222	260	16	25045-6813	23	8.875	9.875	0.500	225	251	13
24610-6434	26-L	8.750	10.250	0.656	222	260	17	25003-6813	23	8.875	9.875	0.500	225	251	13
21086-3946	53	8.750	10.250	0.688	222	260	17	25003-3832	23	8.875	10.125	0.625	225	257	16
21702-3946	62	8.750	10.250	0.688	222	260	17	25003-5153	23	8.875	10.125	0.625	225	257	16
21247-3946	64	8.750	10.250	0.688	222	260	17	24600-3832	26-L	8.875	10.125	0.625	225	257	16
21773-3946	64	8.750	10.250	0.688	222	260	17	24715-3832	59	8.875	10.125	0.625	225	257	16
21238-3946	64	8.750	10.250	0.688	222	260	17	24700-3832	59	8.875	10.125	0.625	225	257	16
21243-3946	64	8.750	10.250	0.688	222	260	17	24707-3832	59	8.875	10.125	0.625	225	257	16
21852-3946	64	8.750	10.250	0.688	222	260	17	26081-3832	87	8.875	10.125	0.625	225	257	16
29604-2017	GD	8.750	10.250	0.700	222	260	18	26080-3832	87	8.875	10.125	0.625	225	257	16
25003-3947	23	8.750	10.250	0.750	222	260	19	24821-3832	EQUAL	8.875	10.125	0.625	225	257	16
21086-3947	53	8.750	10.250	0.750	222	260	19	24600-1914	26-L	8.875	10.125	0.750	225	257	19
29500-2017	IG	8.750	10.250	0.750	222	260	19	24751-1914	59G1	8.875	10.125	0.750	225	257	19
25003-2615	23	8.750	10.312	0.625	222	262	16	25003-2244	23	8.875	10.250	0.750	225	260	19

All dimensions are in inches. Preferred sizes are indicated with **bold** type face. Sizes listed are for standard nitrile elements, except Models 25 and 62 which have PTFE elements. Other material available on inquiry only.

## Oil Seals by Model Number

Product Code	Model	Inches			MM			Product Code	Model	Inches			MM		
		ID	OD	Width	ID	OD	Width			ID	OD	Width	ID	OD	Width
25010-8177	23	8.875	10.375	0.500	225	264	13	25006-4505	23	9.000	10.250	0.625	229	260	16
25003-8177	23	8.875	10.375	0.500	225	264	13	25004-4505	23	9.000	10.250	0.625	229	260	16
25003-7336	23	8.875	10.375	0.750	225	264	19	25058-4505	25	9.000	10.250	0.625	229	260	16
25003-5213	23	8.875	10.500	0.750	225	267	19	24627-4505	26-L	9.000	10.250	0.625	229	260	16
25003-5559	23	8.875	10.625	0.812	225	270	21	24610-4505	26-L	9.000	10.250	0.625	229	260	16
21702-9438	62	8.875	10.750	0.750	225	273	19	24602-4505	26-L	9.000	10.250	0.625	229	260	16
25003-3599	23	8.875	10.875	0.625	225	276	16	24612-4505	26-L	9.000	10.250	0.625	229	260	16
25003-6646	23	8.875	10.875	0.750	225	276	19	21086-4505	53	9.000	10.250	0.625	229	260	16
24700-6646	59	8.875	10.875	0.750	225	276	19	21477-4505	53	9.000	10.250	0.625	229	260	16
25003-3953	23	8.875	10.875	0.813	225	276	21	24700-4505	59	9.000	10.250	0.625	229	260	16
21852-3953	64	8.875	10.875	0.813	225	276	21	21086-3617	53	9.000	10.250	0.750	229	260	19
21238-3953	64	8.875	10.875	0.813	225	276	21	25005-9108	24	9.000	10.375	0.500	229	264	13
24600-3833	26-L	8.875	10.875	1.000	225	276	25	21086-4506	53	9.000	10.375	0.625	229	264	16
25003-6273	23	8.937	9.968	0.500	227	253	13	25003-5952	23	9.000	10.500	0.500	229	267	13
25003-1235	23	8.937	10.500	0.750	227	267	19	25006-5952	23	9.000	10.500	0.500	229	267	13
25003-9151	23	8.938	9.938	0.500	227	252	13	25004-5952	23	9.000	10.500	0.500	229	267	13
25003-6797	23	8.938	10.000	0.500	227	254	13	24600-0809	26-L	9.000	10.500	0.500	229	267	13
25003-6190	23	8.938	10.188	0.625	227	259	16	24626-0809	26-L	9.000	10.500	0.500	229	267	13
24702-4349	59	8.938	10.437	0.750	227	265	19	25003-1963	23	9.000	10.500	0.563	229	267	14
25006-1220	23	8.938	10.438	0.750	227	265	19	25054-8494	23	9.000	10.500	0.609	229	267	15
24816-7052	EQUAL	8.938	10.443	1.563	227	265	40	25003-8494	23	9.000	10.500	0.609	229	267	15
25003-2721	23	8.970	10.500	0.500	228	267	13	25003-4507	23	9.000	10.500	0.625	229	267	16
25003-3089	23	8.976	10.630	0.630	228	270	16	21096-4507	53	9.000	10.500	0.625	229	267	16
24612-1279	26-L	9.000	10.000	0.437	229	254	11	21086-4507	53	9.000	10.500	0.625	229	267	16
25003-9201	23	9.000	10.000	0.438	229	254	11	21699-4507	53	9.000	10.500	0.625	229	267	16
24610-1279	26-L	9.000	10.000	0.438	229	254	11	24700-0030	59	9.000	10.500	0.625	229	267	16
24600-3834	26-L	9.000	10.000	0.469	229	254	12	21702-4507	62	9.000	10.500	0.625	229	267	16
25001-6387	21	9.000	10.000	0.500	229	254	13	24627-2984	26-L	9.000	10.500	0.656	229	267	17
25008-6387	21	9.000	10.000	0.500	229	254	13	21086-3954	53	9.000	10.500	0.688	229	267	17
25002-6387	21	9.000	10.000	0.500	229	254	13	24702-3150	59	9.000	10.500	0.688	229	267	17
25003-6387	23	9.000	10.000	0.500	229	254	13	21247-3954	64	9.000	10.500	0.688	229	267	17
25004-6387	23	9.000	10.000	0.500	229	254	13	21937-3954	64	9.000	10.500	0.688	229	267	17
25058-6387	25	9.000	10.000	0.500	229	254	13	21238-3954	64	9.000	10.500	0.688	229	267	17
25003-4503	23	9.000	10.000	0.625	229	254	16	21852-3954	64	9.000	10.500	0.688	229	267	17
25004-4503	23	9.000	10.000	0.625	229	254	16	21243-3954	64	9.000	10.500	0.688	229	267	17
21096-4503	53	9.000	10.000	0.625	229	254	16	25006-3619	23	9.000	10.500	0.750	229	267	19
21087-4503	53	9.000	10.000	0.625	229	254	16	25003-3619	23	9.000	10.500	0.750	229	267	19
21086-4503	53	9.000	10.000	0.625	229	254	16	25058-3619	25	9.000	10.500	0.750	229	267	19
21477-4503	53	9.000	10.000	0.625	229	254	16	24627-3619	26-L	9.000	10.500	0.750	229	267	19
21699-4503	53	9.000	10.000	0.625	229	254	16	24600-3619	26-L	9.000	10.500	0.750	229	267	19
21095-4503	53	9.000	10.000	0.625	229	254	16	21699-3619	53	9.000	10.500	0.750	229	267	19
24700-4503	59	9.000	10.000	0.625	229	254	16	21086-3619	53	9.000	10.500	0.750	229	267	19
21702-4503	62	9.000	10.000	0.625	229	254	16	24060-3619	61	9.000	10.500	0.750	229	267	19
29602-3615	GD	9.000	10.000	0.700	229	254	18	22537-6521	53R1	9.000	10.500	1.375	229	267	35
21432-3615	142	9.000	10.000	0.750	229	254	19	22627-6521	53R2	9.000	10.500	1.375	229	267	35
21086-3615	53	9.000	10.000	0.750	229	254	19	25003-4508	23	9.000	10.625	0.625	229	270	16
25003-0579	23	9.000	10.032	0.500	229	255	13	21086-4508	53	9.000	10.625	0.625	229	270	16
25003-0985	23	9.000	10.125	0.500	229	257	13	25003-3620	23	9.000	10.625	0.750	229	270	19
25003-6423	23	9.000	10.125	0.547	229	257	14	25003-3160	23	9.000	10.672	0.750	229	271	19
25003-4504	23	9.000	10.125	0.625	229	257	16	25003-3621	23	9.000	10.750	0.750	229	273	19
25006-4504	23	9.000	10.125	0.625	229	257	16	24610-3621	26-L	9.000	10.750	0.750	229	273	19
21086-4504	53	9.000	10.125	0.625	229	257	16	21086-3621	53	9.000	10.750	0.750	229	273	19
25003-3616	23	9.000	10.125	0.750	229	257	19	25003-3622	23	9.000	10.875	0.750	229	276	19
21086-3616	53	9.000	10.125	0.750	229	257	19	21086-3622	53	9.000	10.875	0.750	229	276	19
25010-4505	23	9.000	10.250	0.625	229	260	16	25003-1165	23	9.000	10.910	0.813	229	277	21
25003-4505	23	9.000	10.250	0.625	229	260	16	25001-8564	21	9.000	10.910	0.838	229	277	21

All dimensions are in inches. Preferred sizes are indicated with **bold** type face.

Sizes listed are for standard nitrile elements, except Models 25 and 62 which have PTFE elements. Other material available on inquiry only.

## Oil Seals by Model Number

Product Code	Model	Inches			MM			Product Code	Model	Inches			MM		
		ID	OD	Width	ID	OD	Width			ID	OD	Width	ID	OD	Width
25003-9948	23	9.000	11.000	0.625	229	279	16	24620-3956	26R1-L	9.055	10.591	0.866	230	269	22
24612-0032	26-L	9.000	11.000	0.625	229	279	16	24600-3956	26-L	9.055	10.591	0.866	230	269	22
24700-0032	59	9.000	11.000	0.625	229	279	16	24700-5814	59	9.055	10.630	0.591	230	270	15
25001-3623	21	9.000	11.000	0.750	229	279	19	25006-1222	23	9.056	10.433	0.709	230	265	18
25010-3623	23	9.000	11.000	0.750	229	279	19	24700-4763	59	9.056	10.630	0.630	230	270	16
25003-3623	23	9.000	11.000	0.750	229	279	19	25010-1157	23	9.056	11.024	0.788	230	280	20
25006-3623	23	9.000	11.000	0.750	229	279	19	25004-5575	23	9.062	10.062	0.375	230	256	10
24626-3623	26-L	9.000	11.000	0.750	229	279	19	25003-7322	23	9.062	10.062	0.500	230	256	13
24627-3623	26-L	9.000	11.000	0.750	229	279	19	25004-7322	23	9.062	10.062	0.500	230	256	13
24600-3623	26-L	9.000	11.000	0.750	229	279	19	25003-8838	23	9.062	10.500	0.750	230	267	19
21086-3623	53	9.000	11.000	0.750	229	279	19	25003-6092	23	9.062	11.062	0.750	230	281	19
21699-3623	53	9.000	11.000	0.750	229	279	19	25003-5575	23	9.063	10.062	0.375	230	256	10
26180-3623	87NS	9.000	11.000	0.750	229	279	19	24700-6180	59	9.063	10.750	0.750	230	273	19
26186-3623	88NS	9.000	11.000	0.750	229	279	19	21333-2529	143	9.094	10.406	0.781	231	264	20
25003-3955	23	9.000	11.000	0.813	229	279	21	25003-3195	23	9.125	10.125	0.375	232	257	10
25006-3955	23	9.000	11.000	0.813	229	279	21	25003-6756	23	9.125	10.125	0.500	232	257	13
21247-3955	64	9.000	11.000	0.813	229	279	21	25003-4803	23	9.125	10.375	0.625	232	264	16
21238-3955	64	9.000	11.000	0.813	229	279	21	24600-4803	26-L	9.125	10.375	0.625	232	264	16
21852-3955	64	9.000	11.000	0.813	229	279	21	24610-4803	26-L	9.125	10.375	0.625	232	264	16
24610-3624	26-L	9.000	11.000	1.000	229	279	25	24700-4803	59	9.125	10.375	0.625	232	264	16
21096-3624	53	9.000	11.000	1.000	229	279	25	24700-0037	59	9.125	10.625	0.625	232	270	16
21086-3624	53	9.000	11.000	1.000	229	279	25	21852-3957	64	9.125	10.625	0.687	232	270	17
21095-3624	53	9.000	11.000	1.000	229	279	25	21238-3957	64	9.125	10.625	0.688	232	270	17
21702-3624	62	9.000	11.000	1.000	229	279	25	25003-3958	23	9.125	10.625	0.750	232	270	19
22537-5949	53R1	9.000	11.000	1.375	229	279	35	21086-3958	53	9.125	10.625	0.750	232	270	19
24700-0033	59	9.000	11.054	0.750	229	281	19	22897-7823	53T2	9.125	10.625	1.250	232	270	32
25003-5403	23	9.055	10.039	0.500	230	255	13	24700-0038	59	9.125	10.750	0.625	232	273	16
25003-2485	23	9.055	10.180	0.494	230	259	13	25003-3959	23	9.125	10.750	0.750	232	273	19
25003-1109	23	9.055	10.189	0.625	230	259	16	21086-3959	53	9.125	10.750	0.750	232	273	19
25003-3123	23	9.055	10.236	0.394	230	260	10	21699-3959	53	9.125	10.750	0.750	232	273	19
25003-5334	23	9.055	10.236	0.590	230	260	15	25003-0466	23	9.125	10.799	0.703	232	274	18
24637-3955	26	9.055	10.236	.591	230	260	15	21086-3961	53	9.125	11.000	0.750	232	279	19
24650-3955	26NS-L	9.055	10.236	0.591	230	260	15	24700-0039	59	9.125	11.125	0.625	232	283	16
24638-3955	26-L	9.055	10.236	.591	230	260	15	25003-5745	23	9.125	11.125	0.750	232	283	19
24626-3955	26-L	9.055	10.236	0.591	230	260	15	21840-3962	64	9.125	11.125	0.812	232	283	21
24600-3955	26-L	9.055	10.236	0.591	230	260	15	21238-3962	64	9.125	11.125	0.813	232	283	21
24700-3955	59	9.055	10.236	0.591	230	260	15	24627-3625	26-L	9.125	11.125	1.000	232	283	25
26081-5334	87	9.055	10.236	0.591	230	260	15	22987-6726	53F1	9.125	11.125	1.250	232	283	32
26080-5334	87	9.055	10.236	0.591	230	260	15	21238-8765	64	9.134	10.625	0.687	232	270	17
26086-5334	88	9.055	10.236	0.591	230	260	15	25003-5126	23	9.156	10.656	0.750	233	271	19
26088-5334	88	9.055	10.236	0.591	230	260	15	25003-9295	23	9.188	10.688	0.750	233	271	19
25003-5784	23	9.055	10.551	0.750	230	268	19	25003-7640	23	9.250	10.125	0.375	235	257	10
24700-0035	59	9.055	10.621	0.629	230	270	16	25010-1443	23	9.250	10.236	0.393	235	260	10
25003-7890	23	9.055	10.629	0.551	230	270	14	25003-5320	23	9.250	10.250	0.438	235	260	11
24700-4035	59	9.055	10.629	0.551	230	270	14	25003-6676	23	9.250	10.250	0.500	235	260	13
21086-7890	53	9.055	10.630	0.551	230	270	14	25003-4509	23	9.250	10.250	0.625	235	260	16
24627-5814	26-L	9.055	10.630	0.590	230	270	15	25004-4509	23	9.250	10.250	0.625	235	260	16
25003-4885	23	9.055	10.630	0.630	230	270	16	21087-4509	53	9.250	10.250	0.625	235	260	16
25006-4885	23	9.055	10.630	0.630	230	270	16	21086-4509	53	9.250	10.250	0.625	235	260	16
29502-6601	16	9.055	10.630	0.750	230	270	19	21093-4509	53	9.250	10.250	0.625	235	260	16
25003-5374	23	9.055	10.866	0.684	230	276	17	21947-4509	53	9.250	10.250	0.625	235	260	16
24700-0036	59	9.055	11.024	0.625	230	280	16	21699-4509	53	9.250	10.250	0.625	235	260	16
25003-4865	23	9.055	11.024	0.630	230	280	16	21432-3628	142	9.250	10.250	0.750	235	260	19
25006-5334	23	9.055	10.236	0.591	230	260	15	21443-3628	142	9.250	10.250	0.750	235	260	19
24610-3955	26-L	9.055	10.236	0.591	230	260	15	21086-3628	53	9.250	10.250	0.750	235	260	19
26058-5334	57	9.055	10.236	0.591	230	260	15	25003-3255	23	9.250	10.375	0.625	235	264	16

All dimensions are in inches. Preferred sizes are indicated with **bold** type face. Sizes listed are for standard nitrile elements, except Models 25 and 62 which have PTFE elements. Other material available on inquiry only.

## Oil Seals by Model Number

Product Code	Model	Inches			MM			Product Code	Model	Inches			MM		
		ID	OD	Width	ID	OD	Width			ID	OD	Width	ID	OD	Width
21096-3629	53	9.250	10.375	0.750	235	264	19	24700-0044	59	9.250	11.250	0.750	235	286	19
21086-3629	53	9.250	10.375	0.750	235	264	19	24702-0044	59	9.250	11.250	0.750	235	286	19
25135-1526	23	9.250	10.432	0.591	235	265	15	21702-3967	62	9.250	11.250	0.750	235	286	19
25003-2914	23	9.250	10.500	0.375	235	267	10	25003-9875	23	9.250	11.250	0.813	235	286	21
25003-4724	23	9.250	10.500	0.500	235	267	13	24600-3633	26-L	9.250	11.250	1.000	235	286	25
25003-4511	23	9.250	10.500	0.625	235	267	16	24610-3633	26-L	9.250	11.250	1.000	235	286	25
25010-4511	23	9.250	10.500	0.625	235	267	16	21086-3633	53	9.250	11.250	1.000	235	286	25
25004-4511	23	9.250	10.500	0.625	235	267	16	22627-7562	53R2	9.250	11.250	1.375	235	286	35
24648-0041	26R1-L	9.250	10.500	0.625	235	267	16	22897-7562	53T2	9.250	11.250	1.375	235	286	35
24620-0041	26R1-L	9.250	10.500	0.625	235	267	16	24700-0045	59	9.250	11.375	0.875	235	289	22
24626-0041	26-L	9.250	10.500	0.625	235	267	16	21332-2585	143	9.312	10.625	0.781	237	270	20
24600-0041	26-L	9.250	10.500	0.625	235	267	16	25006-0816	23	9.313	11.125	0.688	237	283	17
21086-4511	53	9.250	10.500	0.625	235	267	16	24627-0912	26-L	9.313	11.313	1.000	237	287	25
24715-0041	59	9.250	10.500	0.625	235	267	16	24612-0912	26-L	9.313	11.313	1.000	237	287	25
24700-0041	59	9.250	10.500	0.625	235	267	16	25003-9544	23	9.375	10.625	0.500	238	270	13
24702-0041	59	9.250	10.500	0.625	235	267	16	25011-6648	23	9.375	10.625	0.625	238	270	16
21086-3630	53	9.250	10.500	0.750	235	267	19	25003-6648	23	9.375	10.625	0.625	238	270	16
25003-7831	23	9.250	10.625	0.750	235	270	19	25010-6648	23	9.375	10.625	0.625	238	270	16
25003-8179	23	9.250	10.750	0.500	235	273	13	24700-0048	59	9.375	10.625	0.625	238	270	16
25003-6595	23	9.250	10.750	0.625	235	273	16	25011-3971	23	9.375	10.875	0.750	238	276	19
24715-0042	59	9.250	10.750	0.625	235	273	16	25003-3971	23	9.375	10.875	0.750	238	276	19
24700-0042	59	9.250	10.750	0.625	235	273	16	25144-3971	23	9.375	10.875	0.750	238	276	19
24702-0042	59	9.250	10.750	0.625	235	273	16	24700-0049	59	9.375	10.875	0.750	238	276	19
24600-3840	26-L	9.250	10.750	0.656	235	273	17	24700-1343	59	9.375	11.000	0.625	238	279	16
21086-3963	53	9.250	10.750	0.688	235	273	17	25003-3972	23	9.375	11.000	0.750	238	279	19
21247-3963	64	9.250	10.750	0.688	235	273	17	21086-3972	53	9.375	11.000	0.750	238	279	19
21238-3963	64	9.250	10.750	0.688	235	273	17	25003-2580	23	9.375	11.250	0.750	238	286	19
21852-3963	64	9.250	10.750	0.688	235	273	17	21086-3975	53	9.375	11.375	0.750	238	289	19
25010-3632	23	9.250	10.750	0.750	235	273	19	25003-4610	23	9.375	11.375	0.813	238	289	21
25003-3632	23	9.250	10.750	0.750	235	273	19	21238-4610	64	9.375	11.375	0.813	238	289	21
24610-0801	26-L	9.250	10.750	0.750	235	273	19	21096-3634	53	9.375	11.375	1.000	238	289	25
21096-3632	53	9.250	10.750	0.750	235	273	19	21086-3634	53	9.375	11.375	1.000	238	289	25
21086-3632	53	9.250	10.750	0.750	235	273	19	25003-0476	23	9.409	10.909	0.625	239	277	16
22537-5021	53R1	9.250	10.750	1.375	235	273	35	21086-3977	53	9.437	10.500	0.625	240	267	16
22627-5021	53R2	9.250	10.750	1.375	235	273	35	21086-3635	53	9.437	10.500	0.750	240	267	19
25003-3647	23	9.250	10.826	0.625	235	275	16	25003-0528	23	9.437	10.750	0.625	240	273	16
21086-3964	53	9.250	10.875	0.750	235	276	19	25003-8753	23	9.438	10.438	0.500	240	265	13
24700-0043	59	9.250	11.000	0.625	235	279	16	25003-3977	23	9.438	10.500	0.625	240	267	16
25003-3965	23	9.250	11.000	0.750	235	279	19	25003-7447	23	9.438	10.625	0.625	240	270	16
21086-3965	53	9.250	11.000	0.750	235	279	19	21086-7447	53	9.438	10.625	0.625	240	270	16
22537-6663	53R1	9.250	11.000	1.375	235	279	35	25010-3636	23	9.438	10.625	0.750	240	270	19
22627-6663	53R2	9.250	11.000	1.375	235	279	35	25003-3636	23	9.438	10.625	0.750	240	270	19
24700-4481	59	9.250	11.250	0.563	235	286	14	21086-3636	53	9.438	10.625	0.750	240	270	19
25010-9172	23	9.250	11.250	0.625	235	286	16	24700-0051	59	9.438	10.625	0.750	240	270	19
25003-9172	23	9.250	11.250	0.625	235	286	16	25003-8447	23	9.438	10.688	0.625	240	271	16
25006-9172	23	9.250	11.250	0.625	235	286	16	25003-9916	23	9.438	10.938	0.750	240	278	19
24610-9388	26-L	9.250	11.250	0.625	235	286	16	24700-0052	59	9.438	11.500	0.875	240	292	22
25010-3967	23	9.250	11.250	0.750	235	286	19	24700-5932	59	9.438	11.500	1.000	240	292	25
25003-3967	23	9.250	11.250	0.750	235	286	19	25003-9941	23	9.445	10.633	0.500	240	270	13
24620-0044	26R1-L	9.250	11.250	0.750	235	286	19	25003-6991	23	9.448	10.448	0.500	240	265	13
24600-0044	26-L	9.250	11.250	0.750	235	286	19	25003-5359	23	9.448	10.629	0.590	240	270	15
21087-3967	53	9.250	11.250	0.750	235	286	19	25006-5359	23	9.448	10.629	0.590	240	270	15
21086-3967	53	9.250	11.250	0.750	235	286	19	21086-5359	53	9.448	10.629	0.590	240	270	15
21947-3967	53	9.250	11.250	0.750	235	286	19	24702-5359	59	9.448	10.629	0.590	240	270	15
21699-3967	53	9.250	11.250	0.750	235	286	19	25003-5852	23	9.448	10.948	0.750	240	278	19
21003-3967	58	9.250	11.250	0.750	235	286	19	21086-7891	53	9.448	11.023	0.629	240	280	16

All dimensions are in inches. Preferred sizes are indicated with **bold** type face.

Sizes listed are for standard nitrile elements, except Models 25 and 62 which have PTFE elements. Other material available on inquiry only.

## Oil Seals by Model Number

Product Code	Model	Inches			MM			Product Code	Model	Inches			MM		
		ID	OD	Width	ID	OD	Width			ID	OD	Width	ID	OD	Width
25003-9435	23	9.448	11.024	0.787	240	280	20	21238-3145	64	9.500	10.750	0.563	241	273	14
25003-5380	23	9.448	11.259	0.684	240	286	17	25003-3640	23	9.500	10.750	0.625	241	273	16
25003-3132	23	9.448	11.417	0.630	240	290	16	25006-3640	23	9.500	10.750	0.625	241	273	16
24600-0828	26-L	9.448	12.598	0.984	240	320	25	24629-3640	26-L	9.500	10.750	0.625	241	273	16
24650-5359	26-L	9.449	10.630	0.591	240	270	15	24600-3640	26-L	9.500	10.750	0.625	241	273	16
24608-5359	26R1-L	9.449	10.630	0.591	240	270	15	21086-3640	53	9.500	10.750	0.625	241	273	16
24600-5359	26-L	9.449	10.630	0.591	240	270	15	21699-3640	53	9.500	10.750	0.625	241	273	16
24715-5359	59	9.449	10.630	0.591	240	270	15	21095-3640	53	9.500	10.750	0.625	241	273	16
24600-2041	26-L	9.449	11.024	0.591	240	280	15	24715-3640	59	9.500	10.750	0.625	241	273	16
24620-3974	26R1-L	9.449	11.417	0.748	240	290	19	24700-3640	59	9.500	10.750	0.625	241	273	16
24626-5359	26-L	9.449	10.630	0.591	240	270	15	22627-6942	53R2	9.500	10.750	1.375	241	273	35
24602-5359	26-L	9.449	10.630	0.591	240	270	15	25003-3105	23	9.500	10.875	0.750	241	276	19
24700-5359	59	9.449	10.630	0.594	240	270	15	25003-2530	23	9.500	10.937	0.750	241	278	19
29502-6725	1G	9.449	10.630	0.750	240	270	19	25003-8388	23	9.500	11.000	0.500	241	279	13
24602-3910	26-L	9.449	10.827	0.630	240	275	16	25001-3642	21	9.500	11.000	0.625	241	279	16
24667-3910	26-L	9.449	10.827	0.630	240	275	16	25003-3642	23	9.500	11.000	0.625	241	279	16
25003-1036	23	9.449	10.827	0.709	240	275	18	21086-3642	53	9.500	11.000	0.625	241	279	16
25006-1036	23	9.449	10.827	0.709	240	275	18	21096-3642	53	9.500	11.000	0.625	241	279	16
24610-5635	26-L	9.449	10.828	0.591	240	275	15	24700-0055	59	9.500	11.000	0.625	241	279	16
24600-3910	26-L	9.449	10.828	0.630	240	275	16	24600-3842	26-L	9.500	11.000	0.688	241	279	17
26057-3910	57	9.449	10.828	0.630	240	275	16	25001-3979	21	9.500	11.000	0.750	241	279	19
29504-5399	1G	9.449	10.949	0.750	240	278	19	25003-3979	23	9.500	11.000	0.750	241	279	19
25006-7891	23	9.449	11.023	0.630	240	280	16	25006-3979	23	9.500	11.000	0.750	241	279	19
25010-1097	23	9.449	11.024	0.500	240	280	13	25058-3979	25	9.500	11.000	0.750	241	279	19
24626-2041	26-L	9.449	11.024	0.591	240	280	15	24627-3979	26-L	9.500	11.000	0.750	241	279	19
25003-7891	23	9.449	11.024	0.630	240	280	16	24610-3979	26-L	9.500	11.000	0.750	241	279	19
25004-7891	23	9.449	11.024	0.630	240	280	16	29502-3979	1G	9.500	11.000	0.750	241	279	19
24702-2100	59	9.449	11.024	0.630	240	280	16	21086-3643	53	9.500	11.125	0.625	241	283	16
25003-3973	23	9.449	11.024	0.748	240	280	19	21699-3643	53	9.500	11.125	0.625	241	283	16
24626-3973	26-L	9.449	11.024	0.748	240	280	19	24600-3644	26-L	9.500	11.250	0.625	241	286	16
24600-3973	26-L	9.449	11.024	0.748	240	280	19	21086-3644	53	9.500	11.250	0.625	241	286	16
24700-0054	59	9.449	11.811	0.984	240	300	25	25003-3981	23	9.500	11.250	0.750	241	286	19
24600-2044	26-L	9.469	10.625	0.625	241	270	16	21086-3981	53	9.500	11.250	0.750	241	286	19
24700-2044	59	9.469	10.625	0.625	241	270	16	21238-3981	64	9.500	11.250	0.750	241	286	19
25135-1521	23	9.500	10.484	0.492	241	266	12	22627-8909	53R2	9.500	11.250	1.375	241	286	35
24610-3532	26-L	9.500	10.500	0.375	241	267	10	25003-3645	23	9.500	11.375	0.625	241	289	16
25003-6214	23	9.500	10.500	0.438	241	267	11	25003-5463	23	9.500	11.437	0.625	241	290	16
24600-3841	26-L	9.500	10.500	0.438	241	267	11	25003-9536	23	9.500	11.500	0.578	241	292	15
24610-3841	26-L	9.500	10.500	0.438	241	267	11	25003-3646	23	9.500	11.500	0.625	241	292	16
25001-6388	21	9.500	10.500	0.500	241	267	13	24626-0055	26-L	9.500	11.500	0.625	241	292	16
25010-6388	23	9.500	10.500	0.500	241	267	13	24600-0055	26-L	9.500	11.500	0.625	241	292	16
25003-6388	23	9.500	10.500	0.500	241	267	13	24610-0055	26-L	9.500	11.500	0.625	241	292	16
25006-6388	23	9.500	10.500	0.500	241	267	13	24602-0055	26-L	9.500	11.500	0.625	241	292	16
25004-6388	23	9.500	10.500	0.500	241	267	13	21087-3646	53	9.500	11.500	0.625	241	292	16
24612-3978	26-L	9.500	10.500	0.500	241	267	13	21086-3646	53	9.500	11.500	0.625	241	292	16
25003-3638	23	9.500	10.500	0.625	241	267	16	24700-0057	59	9.500	11.500	0.625	241	292	16
21086-3638	53	9.500	10.500	0.625	241	267	16	24702-0057	59	9.500	11.500	0.625	241	292	16
21699-3638	53	9.500	10.500	0.625	241	267	16	25003-5960	23	9.500	11.500	0.688	241	292	17
21095-3638	53	9.500	10.500	0.625	241	267	16	25001-3983	21	9.500	11.500	0.750	241	292	19
24715-4401	59	9.500	10.500	0.625	241	267	16	25003-3983	23	9.500	11.500	0.750	241	292	19
21443-4937	142	9.500	10.500	0.750	241	267	19	25001-3984	21	9.500	11.500	0.813	241	292	21
22987-8717	53F1	9.500	10.500	1.000	241	267	25	25003-3984	23	9.500	11.500	0.813	241	292	21
25003-6669	23	9.500	10.625	0.500	241	270	13	21247-3984	64	9.500	11.500	0.813	241	292	21
21086-3639	53	9.500	10.625	0.625	241	270	16	21937-3984	64	9.500	11.500	0.813	241	292	21
25003-8783	23	9.500	10.750	0.500	241	273	13	21238-3984	64	9.500	11.500	0.813	241	292	21
25004-8783	23	9.500	10.750	0.500	241	273	13	21840-3984	64	9.500	11.500	0.813	241	292	21

All dimensions are in inches. Preferred sizes are indicated with **bold** type face. Sizes listed are for standard nitrile elements, except Models 25 and 62 which have PTFE elements. Other material available on inquiry only.

## Oil Seals by Model Number

Product Code	Model	Inches			MM			Product Code	Model	Inches			MM		
		ID	OD	Width	ID	OD	Width			ID	OD	Width	ID	OD	Width
21243-3984	64	9.500	11.500	0.813	241	292	21	21096-4513	53	9.750	10.750	0.625	248	273	16
21385-3984	64	9.500	11.500	0.813	241	292	21	21086-4513	53	9.750	10.750	0.625	248	273	16
21852-3984	64	9.500	11.500	0.813	241	292	21	24700-2914	59	9.750	10.750	0.625	248	273	16
24627-3648	26-L	9.500	11.500	1.000	241	292	25	21086-3650	53	9.750	10.750	0.750	248	273	19
24600-3648	26-L	9.500	11.500	1.000	241	292	25	21086-4514	53	9.750	10.875	0.625	248	276	16
24610-3648	26-L	9.500	11.500	1.000	241	292	25	25010-6390	23	9.750	11.000	0.500	248	279	13
24602-3648	26-L	9.500	11.500	1.000	241	292	25	25025-6390	23	9.750	11.000	0.500	248	279	13
21096-3648	53	9.500	11.500	1.000	241	292	25	25003-6390	23	9.750	11.000	0.500	248	279	13
21086-3648	53	9.500	11.500	1.000	241	292	25	25135-4515	23	9.750	11.000	0.625	248	279	16
21477-3648	53	9.500	11.500	1.000	241	292	25	25003-4515	23	9.750	11.000	0.625	248	279	16
22987-7909	53F1	9.500	11.500	1.250	241	292	32	24600-4515	26-L	9.750	11.000	0.625	248	279	16
22537-4925	53R1	9.500	11.500	1.313	241	292	33	24610-4515	26-L	9.750	11.000	0.625	248	279	16
24600-2149	26-L	9.528	10.709	0.591	242	272	15	21699-4515	53	9.750	11.000	0.625	248	279	16
25003-4823	23	9.563	10.563	0.500	243	268	13	21086-4515	53	9.750	11.000	0.625	248	279	16
25003-9888	23	9.563	10.813	0.625	243	275	16	21806-4515	53	9.750	11.000	0.625	248	279	16
24839-7046	EQUAL	9.563	11.028	1.625	243	280	41	24700-4515	59	9.750	11.000	0.625	248	279	16
25003-8846	23	9.563	11.062	0.625	243	281	16	25003-3652	23	9.750	11.000	0.750	248	279	19
24700-6044	59	9.620	10.625	0.625	244	270	16	25058-3652	25	9.750	11.000	0.750	248	279	19
24716-6044	59	9.620	10.625	0.625	244	270	16	21086-3652	53	9.750	11.000	0.750	248	279	19
24700-0058	59	9.620	10.875	0.625	244	276	16	22537-9713	53R1	9.750	11.000	1.375	248	279	35
25003-7835	23	9.625	10.500	0.500	244	267	13	21238-1692	64	9.750	11.125	0.563	248	283	14
25011-7889	23	9.625	10.625	0.500	244	270	13	25003-4516	23	9.750	11.125	0.625	248	283	16
25003-7889	23	9.625	10.625	0.500	244	270	13	21086-4516	53	9.750	11.125	0.625	248	283	16
25144-7889	23	9.625	10.625	0.500	244	270	13	24700-0061	59	9.750	11.125	0.625	248	283	16
25003-6664	23	9.625	10.875	0.500	244	276	13	24600-1922	26-L	9.750	11.125	0.750	248	283	19
25006-6664	23	9.625	10.875	0.500	244	276	13	21086-3653	53	9.750	11.125	0.750	248	283	19
25003-8313	23	9.625	10.875	0.625	244	276	16	25003-6201	23	9.750	11.160	0.588	248	283	15
24600-8313	26-L	9.625	10.875	0.625	244	276	16	25003-4517	23	9.750	11.250	0.625	248	286	16
24610-8313	26-L	9.625	10.875	0.625	244	276	16	25058-4517	25	9.750	11.250	0.625	248	286	16
25003-4512	23	9.625	10.875	0.750	244	276	19	21086-4517	53	9.750	11.250	0.625	248	286	16
25006-4512	23	9.625	10.875	0.750	244	276	19	24751-0062	59G1	9.750	11.250	0.625	248	286	16
21086-4512	53	9.625	10.875	0.750	244	276	19	25003-3985	23	9.750	11.250	0.688	248	286	17
25003-2343	23	9.625	11.000	0.750	244	279	19	21247-3985	64	9.750	11.250	0.688	248	286	17
25003-9300	23	9.625	11.125	0.625	244	283	16	21238-3985	64	9.750	11.250	0.688	248	286	17
25006-9260	23	9.625	11.125	0.750	244	283	19	25003-3654	23	9.750	11.250	0.750	248	286	19
25004-9260	23	9.625	11.125	0.750	244	283	19	24600-3654	26-L	9.750	11.250	0.750	248	286	19
25001-6389	21	9.625	11.625	0.750	244	295	19	21086-3654	53	9.750	11.250	0.750	248	286	19
25003-6389	23	9.625	11.625	0.750	244	295	19	24751-3654	59G1	9.750	11.250	0.750	248	286	19
25006-6389	23	9.625	11.625	0.750	244	295	19	22987-5205	53F1	9.750	11.250	1.000	248	286	25
25003-9594	23	9.625	11.625	0.813	244	295	21	24802-1183	EQUAL	9.750	11.250	1.000	248	286	25
21096-3649	53	9.625	11.625	1.000	244	295	25	25003-1283	23	9.750	11.375	0.750	248	289	19
21086-3649	53	9.625	11.625	1.000	244	295	25	25003-9947	23	9.750	11.750	0.625	248	298	16
21699-3649	53	9.625	11.625	1.000	244	295	25	24715-0064	59	9.750	11.750	0.625	248	298	16
25003-2256	23	9.646	11.142	0.812	245	283	21	21238-9425	64	9.750	11.750	0.688	248	298	17
25003-3988	23	9.687	11.125	0.750	246	283	19	25001-3989	21	9.750	11.750	0.750	248	298	19
24715-4404	59	9.688	10.875	0.625	246	276	16	25003-3989	23	9.750	11.750	0.750	248	298	19
25006-3988	23	9.688	11.125	0.750	246	283	19	21086-3989	53	9.750	11.750	0.750	248	298	19
25003-9253	23	9.688	11.188	0.750	246	284	19	24600-3655	26-L	9.750	11.750	1.000	248	298	25
25003-4989	23	9.724	10.724	0.500	247	272	13	24610-3655	26-L	9.750	11.750	1.000	248	298	25
24700-2189	59	9.725	11.750	0.625	247	298	16	21086-3655	53	9.750	11.750	1.000	248	298	25
25003-1072	23	9.750	10.625	0.500	248	270	13	25003-9317	23	9.774	11.024	0.500	248	280	13
24626-4644	26-L	9.750	10.750	0.438	248	273	11	21333-2805	143	9.812	11.124	0.781	249	283	20
25003-6067	23	9.750	10.750	0.500	248	273	13	29602-5955	GD	9.842	10.593	0.700	250	269	18
25006-6067	23	9.750	10.750	0.500	248	273	13	29500-5955	IG	9.842	10.593	0.750	250	269	19
25003-4513	23	9.750	10.750	0.625	248	273	16	29502-5955	IG	9.842	10.593	0.750	250	269	19
24610-2914	26-L	9.750	10.750	0.625	248	273	16	25004-5339	23	9.842	11.023	0.590	250	280	15

All dimensions are in inches. Preferred sizes are indicated with **bold** type face.

Sizes listed are for standard nitrile elements, except Models 25 and 62 which have PTFE elements. Other material available on inquiry only.

## Oil Seals by Model Number

Product Code	Model	Inches			MM			Product Code	Model	Inches			MM		
		ID	OD	Width	ID	OD	Width			ID	OD	Width	ID	OD	Width
24602-5339	26-L	9.842	11.023	0.590	250	280	15	25003-9145	23	9.938	11.438	0.750	252	291	19
24782-5339	59	9.842	11.023	0.590	250	280	15	25058-9145	25	9.938	11.438	0.750	252	291	19
24783-5339	59	9.842	11.023	0.590	250	280	15	25003-9057	23	9.938	11.500	0.750	252	292	19
29619-6764	GD	9.842	11.023	0.625	250	280	16	25003-5472	23	9.938	11.938	0.750	252	303	19
25003-4497	23	9.842	11.417	0.590	250	290	15	25003-1079	23	9.947	10.875	0.500	253	276	13
25004-8607	23	9.842	11.417	0.629	250	290	16	25003-1064	23	9.947	11.875	0.500	253	302	13
25003-5961	23	9.842	11.467	0.750	250	291	19	25003-8140	23	9.960	10.834	0.375	253	275	10
25003-5375	23	9.842	11.653	0.684	250	296	17	25003-1030	23	10.000	10.875	0.375	254	276	10
25006-1314	23	9.842	11.842	0.750	250	301	19	25003-2068	23	10.000	11.000	0.375	254	279	10
24102-4337	61	9.843	10.630	0.039	250	270	1	24605-4927	26-L	10.000	11.000	0.375	254	279	10
24716-4043	59	9.843	11.024	0.551	250	280	14	24600-4927	26-L	10.000	11.000	0.375	254	279	10
24620-5339	26R1-L	9.843	11.024	0.591	250	280	15	25010-6391	23	10.000	11.000	0.500	254	279	13
21443-8553	142	9.843	10.843	0.750	250	275	19	25138-6391	23	10.000	11.000	0.500	254	279	13
24700-4043	59	9.843	11.024	0.551	250	280	14	25003-6391	23	10.000	11.000	0.500	254	279	13
25003-5339	23	9.843	11.024	0.591	250	280	15	25006-6391	23	10.000	11.000	0.500	254	279	13
25006-5339	23	9.843	11.024	0.591	250	280	15	25004-6391	23	10.000	11.000	0.500	254	279	13
24702-5339	59	9.843	11.024	0.591	250	280	15	24610-3660	26-L	10.000	11.000	0.562	254	279	14
24700-5339	59	9.843	11.024	0.591	250	280	15	24060-3660	61	10.000	11.000	0.562	254	279	14
29519-6989	IG	9.843	11.024	0.625	250	280	16	25003-3660	23	10.000	11.000	0.563	254	279	14
21333-3399	143	9.843	11.155	0.781	250	283	20	21086-3660	53	10.000	11.000	0.563	254	279	14
25006-8607	23	9.843	11.417	0.630	250	290	16	21095-3660	53	10.000	11.000	0.563	254	279	14
24600-6170	26-L	9.843	11.417	0.641	250	290	16	21699-3660	53	10.000	11.000	0.563	254	279	14
25003-9969	23	9.844	10.844	0.500	250	275	13	24700-3660	59	10.000	11.000	0.563	254	279	14
21432-8553	142	9.844	10.844	0.750	250	275	19	24702-3675	59	10.000	11.000	0.688	254	279	17
25010-9676	23	9.844	11.020	0.500	250	280	13	21432-3668	142	10.000	11.000	0.750	254	279	19
25003-9676	23	9.844	11.020	0.500	250	280	13	21086-3668	142	10.000	11.000	0.750	254	279	19
21702-5339	62	9.844	11.024	0.591	250	280	15	21086-3668	53	10.000	11.000	0.750	254	279	19
24600-4345	26-L	9.844	11.024	0.650	250	280	17	21699-3668	53	10.000	11.000	0.750	254	279	19
25003-1099	23	9.844	11.220	0.630	250	285	16	25003-7736	23	10.000	11.125	0.547	254	283	14
25003-1703	23	9.844	11.342	0.748	250	288	19	25003-3661	23	10.000	11.125	0.563	254	283	14
24700-0066	59	9.844	11.409	0.625	250	290	16	21086-3661	53	10.000	11.125	0.563	254	283	14
25003-8607	23	9.844	11.417	0.630	250	290	16	25003-4923	23	10.000	11.250	0.500	254	286	13
25003-9995	23	9.868	11.368	0.750	251	289	19	25006-4923	23	10.000	11.250	0.500	254	286	13
25003-7621	23	9.875	10.875	0.500	251	276	13	25004-4923	23	10.000	11.250	0.500	254	286	13
25003-1441	23	9.875	11.375	0.625	251	289	16	25058-4923	25	10.000	11.250	0.500	254	286	13
25003-3990	23	9.875	11.375	0.750	251	289	19	25003-3662	23	10.000	11.250	0.563	254	286	14
24627-0067	26-L	9.875	11.375	0.750	251	289	19	25004-3662	23	10.000	11.250	0.563	254	286	14
21086-3990	53	9.875	11.375	0.750	251	289	19	21086-3662	53	10.000	11.250	0.563	254	286	14
21477-3990	53	9.875	11.375	0.750	251	289	19	24702-6444	59	10.000	11.250	0.563	254	286	14
24700-0067	59	9.875	11.375	0.750	251	289	19	25004-6808	23	10.000	11.250	0.625	254	286	16
25003-3991	23	9.875	11.500	0.750	251	292	19	24626-6808	26-L	10.000	11.250	0.625	254	286	16
21096-3991	53	9.875	11.500	0.750	251	292	19	24600-6808	26-L	10.000	11.250	0.625	254	286	16
21087-3991	53	9.875	11.500	0.750	251	292	19	24715-6808	59	10.000	11.250	0.625	254	286	16
21086-3991	53	9.875	11.500	0.750	251	292	19	24700-6808	59	10.000	11.250	0.625	254	286	16
24700-5946	59	9.875	11.750	0.875	251	298	22	24702-6808	59	10.000	11.250	0.625	254	286	16
25136-5082	21	9.875	11.875	0.750	251	302	19	25003-3146	23	10.000	11.250	0.688	254	286	17
25003-5082	23	9.875	11.875	0.750	251	302	19	21086-3670	53	10.000	11.250	0.750	254	286	19
24700-3140	59	9.875	11.875	0.969	251	302	25	24751-3670	59G1	10.000	11.250	0.750	254	286	19
24700-0068	59	9.875	12.000	0.875	251	305	22	21332-2586	143	10.000	11.312	0.781	254	287	20
25003-4850	23	9.892	11.338	0.750	251	288	19	25003-2352	23	10.000	11.375	0.500	254	289	13
25003-4618	23	9.937	11.937	0.625	252	303	16	21086-3663	53	10.000	11.375	0.563	254	289	14
21086-3658	53	9.937	12.000	1.000	252	305	25	21086-3671	53	10.000	11.375	0.750	254	289	19
25003-5901	23	9.938	10.938	0.500	252	278	13	25003-8841	23	10.000	11.438	0.750	254	291	19
25003-9272	23	9.938	11.188	0.625	252	284	16	25003-9957	23	10.000	11.500	0.375	254	292	10
25004-9272	23	9.938	11.188	0.625	252	284	16	24610-2545	26-L	10.000	11.500	0.562	254	292	14
24610-4075	26-L	9.938	11.437	0.563	252	290	14	21086-3664	53	10.000	11.500	0.563	254	292	14

All dimensions are in inches. Preferred sizes are indicated with **bold** type face. Sizes listed are for standard nitrile elements, except Models 25 and 62 which have PTFE elements. Other material available on inquiry only.

## Oil Seals by Model Number

Product Code	Model	Inches			MM			Product Code	Model	Inches			MM		
		ID	OD	Width	ID	OD	Width			ID	OD	Width	ID	OD	Width
25010-4950	23	10.000	11.500	0.625	254	292	16	21852-3997	64	10.000	12.000	0.813	254	305	21
25003-4950	23	10.000	11.500	0.625	254	292	16	21086-3998	53	10.000	12.000	0.875	254	305	22
25006-4950	23	10.000	11.500	0.625	254	292	16	21238-3998	64	10.000	12.000	0.875	254	305	22
24627-4950	26-L	10.000	11.500	0.625	254	292	16	25058-3673	25	10.000	12.000	1.000	254	305	25
24700-4950	59	10.000	11.500	0.625	254	292	16	24627-0800	26-L	10.000	12.000	1.000	254	305	25
26180-4950	87NS	10.000	11.500	0.625	254	292	16	24600-0800	26-L	10.000	12.000	1.000	254	305	25
26080-4950	87	10.000	11.500	0.625	254	292	16	24610-0800	26-L	10.000	12.000	1.000	254	305	25
24822-4950	EQUAL	10.000	11.500	0.625	254	292	16	24602-0800	26-L	10.000	12.000	1.000	254	305	25
21226-3992	64	10.000	11.500	0.687	254	292	17	21096-3673	53	10.000	12.000	1.000	254	305	25
25010-3992	23	10.000	11.500	0.688	254	292	17	21086-3673	53	10.000	12.000	1.000	254	305	25
25003-3992	23	10.000	11.500	0.688	254	292	17	24750-0800	59G1	10.000	12.000	1.000	254	305	25
21096-3992	53	10.000	11.500	0.688	254	292	17	22537-8756	53R1	10.000	12.000	1.250	254	305	32
21086-3992	53	10.000	11.500	0.688	254	292	17	22627-6842	53R2	10.000	12.000	1.375	254	305	35
21699-3992	53	10.000	11.500	0.688	254	292	17	22537-8662	53R1	10.000	12.000	1.813	254	305	46
24700-3992	59	10.000	11.500	0.688	254	292	17	25003-4136	23	10.039	11.181	0.630	255	284	16
24702-3992	59	10.000	11.500	0.688	254	292	17	24627-5330	26-L	10.039	11.417	0.591	255	290	15
21238-3992	64	10.000	11.500	0.688	254	292	17	24610-6855	26-L	10.039	11.220	0.591	255	285	15
21852-3992	64	10.000	11.500	0.688	254	292	17	24700-4767	59	10.040	11.418	0.630	255	290	16
21243-3992	64	10.000	11.500	0.688	254	292	17	25003-3469	23	10.040	11.811	0.625	255	300	16
25021-3672	23	10.000	11.500	0.750	254	292	19	25003-4764	23	10.063	11.688	0.750	256	297	19
25010-3672	23	10.000	11.500	0.750	254	292	19	25003-3854	23	10.103	11.103	0.500	257	282	13
25138-3672	23	10.000	11.500	0.750	254	292	19	25003-6219	23	10.125	11.375	0.625	257	289	16
25003-3672	23	10.000	11.500	0.750	254	292	19	25003-1908	23	10.125	11.500	0.625	257	292	16
21086-3672	53	10.000	11.500	0.750	254	292	19	25003-7147	23	10.125	11.500	0.750	257	292	19
22897-3040	53T2	10.000	11.500	1.062	254	292	27	25003-1461	23	10.125	11.625	0.500	257	295	13
25003-3993	23	10.000	11.625	0.750	254	295	19	21086-3999	53	10.125	11.625	0.688	257	295	17
21086-3993	53	10.000	11.625	0.750	254	295	19	24715-0076	59	10.125	11.625	0.688	257	295	17
25003-2344	23	10.000	11.640	0.750	254	296	19	21238-3999	64	10.125	11.625	0.688	257	295	17
25003-3666	23	10.000	11.750	0.563	254	298	14	21852-3999	64	10.125	11.625	0.688	257	295	17
21086-3666	53	10.000	11.750	0.563	254	298	14	25003-4000	23	10.125	11.625	0.750	257	295	19
25003-3994	23	10.000	11.750	0.750	254	298	19	21086-4000	53	10.125	11.625	0.750	257	295	19
24600-3994	26-L	10.000	11.750	0.750	254	298	19	24700-0077	59	10.125	11.750	0.688	257	298	17
21086-3994	53	10.000	11.750	0.750	254	298	19	21238-5989	64	10.125	11.750	0.688	257	298	17
21238-3994	64	10.000	11.750	0.750	254	298	19	21773-5989	64	10.125	11.750	0.688	257	298	17
25003-3667	23	10.000	11.875	0.563	254	302	14	21852-5989	64	10.125	11.750	0.688	257	298	17
21086-3667	53	10.000	11.875	0.563	254	302	14	21243-5989	64	10.125	11.750	0.688	257	298	17
25003-1881	23	10.000	11.875	0.813	254	302	21	25003-3382	23	10.125	11.750	0.750	257	298	19
25001-8742	21	10.000	11.910	0.838	254	303	21	25003-4003	23	10.125	12.000	0.750	257	305	19
25003-3995	23	10.000	12.000	0.625	254	305	16	24600-4003	26-L	10.125	12.000	0.750	257	305	19
25006-3995	23	10.000	12.000	0.625	254	305	16	21086-4003	53	10.125	12.000	0.750	257	305	19
24610-0074	26-L	10.000	12.000	0.625	254	305	16	21086-3674	53	10.125	12.000	1.000	257	305	25
24700-0074	59	10.000	12.000	0.625	254	305	16	25003-0695	23	10.158	11.417	0.630	258	290	16
25001-5906	21	10.000	12.000	0.688	254	305	17	25003-6216	23	10.188	11.188	0.500	259	284	13
25003-5906	23	10.000	12.000	0.688	254	305	17	25003-7588	23	10.188	11.438	0.625	259	291	16
25006-5906	23	10.000	12.000	0.688	254	305	17	21086-3675	53	10.188	12.250	1.000	259	311	25
21086-5906	53	10.000	12.000	0.688	254	305	17	24700-0078	59	10.188	12.250	1.000	259	311	25
21699-5906	53	10.000	12.000	0.688	254	305	17	25004-0625	23	10.219	11.219	0.500	260	285	13
25006-0686	23	10.000	12.000	0.703	254	305	18	25003-0821	23	10.229	11.729	0.750	260	298	19
25003-3996	23	10.000	12.000	0.750	254	305	19	25003-5351	23	10.236	11.417	0.590	260	290	15
25006-3996	23	10.000	12.000	0.750	254	305	19	24627-5351	26-L	10.236	11.417	0.590	260	290	15
25005-3996	24	10.000	12.000	0.750	254	305	19	24600-5351	26-L	10.236	11.417	0.590	260	290	15
21020-3996	50	10.000	12.000	0.750	254	305	19	25003-3901	23	10.236	11.417	0.630	260	290	16
21086-3996	53	10.000	12.000	0.750	254	305	19	24600-5111	26-L	10.236	11.417	0.630	260	290	16
25003-3997	23	10.000	12.000	0.813	254	305	21	24610-5111	26-L	10.236	11.417	0.630	260	290	16
21247-3997	64	10.000	12.000	0.813	254	305	21	24700-5111	59	10.236	11.417	0.630	260	290	16
21238-3997	64	10.000	12.000	0.813	254	305	21	25003-5957	23	10.236	11.486	0.625	260	292	16

All dimensions are in inches. Preferred sizes are indicated with **bold** type face.

Sizes listed are for standard nitrile elements, except Models 25 and 62 which have PTFE elements. Other material available on inquiry only.



## Oil Seals by Model Number

Product Code	Model	Inches			MM			Product Code	Model	Inches			MM		
		ID	OD	Width	ID	OD	Width			ID	OD	Width	ID	OD	Width
24610-6412	26-L	10.236	11.732	0.625	260	298	16	21087-4005	53	10.250	11.750	0.750	260	298	19
25010-5665	23	10.236	11.732	0.750	260	298	19	21086-4005	53	10.250	11.750	0.750	260	298	19
25003-5665	23	10.236	11.732	0.750	260	298	19	21699-4005	53	10.250	11.750	0.750	260	298	19
25003-3814	23	10.236	11.736	0.625	260	298	16	24715-0082	59	10.250	12.000	0.625	260	305	16
25003-5186	23	10.236	11.736	0.750	260	298	19	25003-4007	23	10.250	12.000	0.750	260	305	19
25003-4041	23	10.236	11.811	0.551	260	300	14	25006-4007	23	10.250	12.000	0.750	260	305	19
25003-7010	23	10.236	11.811	0.630	260	300	16	21086-4007	53	10.250	12.000	0.750	260	305	19
25006-7010	23	10.236	11.811	0.630	260	300	16	24620-4008	26R1-L	10.250	12.250	0.625	260	311	16
24610-2212	26-L	10.236	11.811	0.630	260	300	16	25003-3676	23	10.250	12.250	0.750	260	311	19
24626-5429	26-L	10.236	11.811	0.787	260	300	20	21086-3676	53	10.250	12.250	0.750	260	311	19
24610-5429	26-L	10.236	11.811	0.787	260	300	20	21091-3676	53	10.250	12.250	0.750	260	311	19
24750-5429	59G1	10.236	11.811	0.787	260	300	20	25003-4009	23	10.250	12.250	0.813	260	311	21
24700-5429	59	10.236	11.811	0.787	260	300	20	21852-4009	64	10.250	12.250	0.813	260	311	21
24743-5429	59	10.236	11.811	0.787	260	300	20	24600-3677	26-L	10.250	12.250	1.000	260	311	25
24747-5429	59	10.236	11.811	0.787	260	300	20	21086-3677	53	10.250	12.250	1.000	260	311	25
24745-5429	59	10.236	11.812	0.787	260	300	20	21699-3677	53	10.250	12.250	1.000	260	311	25
25010-4805	23	10.236	11.968	0.787	260	304	20	21243-4015	64	10.250	12.500	0.812	260	318	21
25003-4805	23	10.236	11.968	0.787	260	304	20	21238-4015	64	10.250	12.500	0.813	260	318	21
25006-4805	23	10.236	11.968	0.787	260	304	20	25003-1037	23	10.300	11.550	0.625	262	293	16
25004-4805	23	10.236	11.968	0.787	260	304	20	25003-4778	23	10.313	11.938	0.813	262	303	21
26081-4805	87	10.236	11.969	0.787	260	304	20	25003-2458	23	10.357	11.500	0.625	263	292	16
26095-4805	87	10.236	11.969	0.787	260	304	20	25003-4566	23	10.375	11.500	0.750	264	292	19
25003-1026	23	10.236	12.000	0.813	260	305	21	25003-9133	23	10.375	11.625	0.625	264	295	16
25003-5381	23	10.236	12.047	0.684	260	306	17	24715-0084	59	10.375	11.625	0.625	264	295	16
25003-1292	23	10.236	12.125	0.787	260	308	20	24700-0084	59	10.375	11.625	0.625	264	295	16
25003-0872	23	10.236	12.205	0.630	260	310	16	25003-1146	23	10.375	11.633	0.813	264	295	21
24700-0079	59	10.236	12.590	0.984	260	320	25	25003-6882	23	10.375	11.875	0.500	264	302	13
24700-4999	59	10.236	12.598	0.984	260	320	25	25145-8976	23	10.375	11.875	0.750	264	302	19
24769-5111	59	10.236	11.417	0.630	260	290	16	25138-8976	23	10.375	11.875	0.750	264	302	19
24650-5429	26NS-L	10.236	11.811	0.787	260	300	20	25003-8976	23	10.375	11.875	0.750	264	302	19
24600-5429	26-L	10.236	11.811	0.787	260	300	20	25003-0641	23	10.375	12.000	0.750	264	305	19
24707-5429	59	10.236	11.811	0.866	260	300	22	25003-3759	23	10.375	12.197	0.812	264	310	21
25003-2314	23	10.236	12.244	0.748	260	311	19	21086-4010	53	10.375	12.197	1.000	264	310	25
24700-4891	59	10.237	12.402	0.945	260	315	24	25003-9997	23	10.375	12.250	0.750	264	311	19
25010-9476	23	10.250	11.250	0.500	260	286	13	25006-9966	23	10.425	12.000	0.625	265	305	16
25045-9476	23	10.250	11.250	0.500	260	286	13	25003-2613	23	10.433	11.417	0.625	265	290	16
25003-9476	23	10.250	11.250	0.500	260	286	13	24637-0996	26	10.433	11.417	.630	265	290	16
25006-9476	23	10.250	11.250	0.500	260	286	13	24752-5144	59G1	10.433	11.417	0.755	265	290	19
25004-9476	23	10.250	11.250	0.500	260	286	13	25003-7288	23	10.433	11.683	0.625	265	297	16
24702-4049	59	10.250	11.250	0.500	260	286	13	24626-7288	26-L	10.433	11.683	0.625	265	297	16
24700-4049	59	10.250	11.250	0.500	260	286	13	24600-7288	26-L	10.433	11.683	0.625	265	297	16
25003-9384	23	10.250	11.250	0.625	260	286	16	24782-4073	59	10.433	12.205	0.629	265	310	16
21432-6931	142	10.250	11.250	0.750	260	286	19	24783-4073	59	10.433	12.205	0.629	265	310	16
25003-3198	23	10.250	11.500	0.500	260	292	13	25003-2932	23	10.437	11.937	0.625	265	303	16
25003-6698	23	10.250	11.500	0.625	260	292	16	25003-2913	23	10.438	11.500	0.625	265	292	16
24610-0080	26-L	10.250	11.500	0.625	260	292	16	25003-3150	23	10.438	11.688	0.813	265	297	21
24700-0080	59	10.250	11.500	0.625	260	292	16	25003-9776	23	10.438	11.938	0.750	265	303	19
24702-0080	59	10.250	11.500	0.625	260	292	16	25003-2655	23	10.438	12.000	0.625	265	305	16
25003-5523	23	10.250	11.750	0.625	260	298	16	25003-4812	23	10.438	12.000	0.750	265	305	19
24627-0081	26-L	10.250	11.750	0.625	260	298	16	25005-6758	24	10.438	12.438	0.750	265	316	19
24700-0081	59	10.250	11.750	0.625	260	298	16	24700-0088	59	10.438	12.438	0.875	265	316	22
21086-4004	53	10.250	11.750	0.688	260	298	17	21086-3678	53	10.438	12.500	1.000	265	318	25
21238-4004	64	10.250	11.750	0.688	260	298	17	25003-6568	23	10.441	11.441	0.375	265	291	10
25001-4005	21	10.250	11.750	0.750	260	298	19	25004-6568	23	10.441	11.441	0.375	265	291	10
25003-4005	23	10.250	11.750	0.750	260	298	19	25003-2376	23	10.500	11.500	0.375	267	292	10
24600-4005	26-L	10.250	11.750	0.750	260	298	19	25003-6781	23	10.500	11.500	0.500	267	292	13

All dimensions are in inches. Preferred sizes are indicated with **bold** type face. Sizes listed are for standard nitrile elements, except Models 25 and 62 which have PTFE elements. Other material available on inquiry only.

## Oil Seals by Model Number

Product Code	Model	Inches			MM			Product Code	Model	Inches			MM		
		ID	OD	Width	ID	OD	Width			ID	OD	Width	ID	OD	Width
25006-6781	23	10.500	11.500	0.500	267	292	13	24620-4006	26R1-L	10.500	12.500	0.625	267	318	16
24715-3427	59	10.500	11.500	0.625	267	292	16	24626-4006	26-L	10.500	12.500	0.625	267	318	16
24700-3427	59	10.500	11.500	0.625	267	292	16	24627-4006	26-L	10.500	12.500	0.625	267	318	16
29602-6723	GD	10.500	11.500	0.700	267	292	18	24700-4006	59	10.500	12.500	0.625	267	318	16
25003-9679	23	10.500	11.625	0.547	267	295	14	24702-4006	59	10.500	12.500	0.625	267	318	16
25003-8334	23	10.500	11.750	0.500	267	298	13	25003-4016	23	10.500	12.500	0.750	267	318	19
25006-8334	23	10.500	11.750	0.500	267	298	13	24627-4016	26-L	10.500	12.500	0.750	267	318	19
25004-8334	23	10.500	11.750	0.500	267	298	13	24610-4016	26-L	10.500	12.500	0.750	267	318	19
25001-5934	21	10.500	11.750	0.625	267	298	16	21096-4016	53	10.500	12.500	0.750	267	318	19
25003-5934	23	10.500	11.750	0.625	267	298	16	21086-4016	53	10.500	12.500	0.750	267	318	19
25006-5934	23	10.500	11.750	0.625	267	298	16	21477-4016	53	10.500	12.500	0.750	267	318	19
25004-5934	23	10.500	11.750	0.625	267	298	16	24751-4016	59G1	10.500	12.500	0.750	267	318	19
25058-5934	25	10.500	11.750	0.625	267	298	16	25018-4017	21	10.500	12.500	0.812	267	318	21
24635-3665	26NS-L	10.500	11.750	0.625	267	298	16	25001-4017	21	10.500	12.500	0.813	267	318	21
24626-3665	26-L	10.500	11.750	0.625	267	298	16	25003-4017	23	10.500	12.500	0.813	267	318	21
24600-3665	26-L	10.500	11.750	0.625	267	298	16	21702-4017	62	10.500	12.500	0.813	267	318	21
24715-3665	59	10.500	11.750	0.625	267	298	16	21247-4017	64	10.500	12.500	0.813	267	318	21
24700-3665	59	10.500	11.750	0.625	267	298	16	21238-4017	64	10.500	12.500	0.813	267	318	21
24702-3665	59	10.500	11.750	0.625	267	298	16	21852-4017	64	10.500	12.500	0.813	267	318	21
25003-8565	23	10.500	11.750	0.750	267	298	19	24626-3680	26-L	10.500	12.500	1.000	267	318	25
29518-3679	1G	10.500	11.750	0.875	267	298	22	24627-3680	26-L	10.500	12.500	1.000	267	318	25
25003-1980	23	10.500	11.906	0.766	267	302	19	24600-3680	26-L	10.500	12.500	1.000	267	318	25
25003-6683	23	10.500	12.000	0.500	267	305	13	24602-3680	26-L	10.500	12.500	1.000	267	318	25
21012-4495	113	10.500	12.000	0.625	267	305	16	21619-3680	51	10.500	12.500	1.000	267	318	25
25003-4495	23	10.500	12.000	0.625	267	305	16	21486-3680	51	10.500	12.500	1.000	267	318	25
24715-0090	59	10.500	12.000	0.625	267	305	16	21022-3680	51	10.500	12.500	1.000	267	318	25
24700-0090	59	10.500	12.000	0.625	267	305	16	21086-3680	53	10.500	12.500	1.000	267	318	25
24700-4434	59	10.500	12.000	0.687	267	305	17	22897-7774	53T2	10.500	12.500	1.375	267	318	35
24743-4434	59	10.500	12.000	0.687	267	305	17	21086-3681	53	10.500	12.625	1.000	267	321	25
21222-4011	64	10.500	12.000	0.687	267	305	17	24700-6152	59	10.500	13.375	0.750	267	340	19
25003-4011	23	10.500	12.000	0.688	267	305	17	25003-5639	23	10.530	12.030	0.625	267	306	16
21086-4011	53	10.500	12.000	0.688	267	305	17	25003-4963	23	10.563	12.563	0.750	268	319	19
24702-4434	59	10.500	12.000	0.688	267	305	17	25054-5294	23	10.625	11.625	0.415	270	295	11
24748-4434	59	10.500	12.000	0.688	267	305	17	25003-5294	23	10.625	11.625	0.415	270	295	11
21247-4011	64	10.500	12.000	0.688	267	305	17	25003-5067	23	10.625	11.625	0.625	270	295	16
21937-4011	64	10.500	12.000	0.688	267	305	17	24700-0094	59	10.625	11.813	0.625	270	300	16
21444-4011	64	10.500	12.000	0.688	267	305	17	25003-7432	23	10.625	11.875	0.625	270	302	16
21238-4011	64	10.500	12.000	0.688	267	305	17	25003-6935	23	10.625	12.000	0.750	270	305	19
21217-4011	64	10.500	12.000	0.688	267	305	17	25003-4018	23	10.625	12.125	0.750	270	308	19
21243-4011	64	10.500	12.000	0.688	267	305	17	21086-4018	53	10.625	12.125	0.750	270	308	19
21852-4011	64	10.500	12.000	0.688	267	305	17	24700-0095	59	10.625	12.125	0.750	270	308	19
25003-4012	23	10.500	12.000	0.750	267	305	19	25003-4019	23	10.625	12.250	0.750	270	311	19
25006-4012	23	10.500	12.000	0.750	267	305	19	21087-4019	53	10.625	12.250	0.750	270	311	19
24610-2916	26-L	10.500	12.000	0.750	267	305	19	21086-4019	53	10.625	12.250	0.750	270	311	19
21086-4012	53	10.500	12.000	0.750	267	305	19	25003-4020	23	10.625	12.375	0.750	270	314	19
21699-4012	53	10.500	12.000	0.750	267	305	19	25004-4020	23	10.625	12.375	0.750	270	314	19
25135-1530	23	10.500	12.074	0.787	267	307	20	21086-4020	53	10.625	12.375	0.750	270	314	19
25003-4013	23	10.500	12.125	0.750	267	308	19	21095-4020	53	10.625	12.375	0.750	270	314	19
21086-4013	53	10.500	12.125	0.750	267	308	19	24700-0096	59	10.625	12.375	0.750	270	314	19
24751-4013	59G1	10.500	12.125	0.750	267	308	19	21086-4021	53	10.625	12.500	0.750	270	318	19
25003-4014	23	10.500	12.250	0.750	267	311	19	24700-0097	59	10.625	12.500	0.750	270	318	19
21087-4014	53	10.500	12.250	0.750	267	311	19	22987-6447	53F1	10.625	12.500	0.969	270	318	25
21086-4014	53	10.500	12.250	0.750	267	311	19	22987-7585	53F1	10.625	12.500	1.000	270	318	25
25003-1971	23	10.500	12.500	0.500	267	318	13	25003-6704	23	10.625	12.625	0.750	270	321	19
24629-4006	26-L	10.500	12.500	0.625	267	318	16	25003-6428	23	10.625	12.625	0.813	270	321	21
24648-4006	26R1-L	10.500	12.500	0.625	267	318	16	25144-6428	23	10.625	12.625	0.813	270	321	21

All dimensions are in inches. Preferred sizes are indicated with **bold** type face.

Sizes listed are for standard nitrile elements, except Models 25 and 62 which have PTFE elements. Other material available on inquiry only.

## Oil Seals by Model Number

Product Code	Model	Inches			MM			Product Code	Model	Inches			MM		
		ID	OD	Width	ID	OD	Width			ID	OD	Width	ID	OD	Width
24700-0098	59	10.625	13.000	0.750	270	330	19	25004-3686	23	10.750	12.500	0.563	273	318	14
25003-7709	23	10.629	11.629	0.409	270	295	10	24600-3686	26-L	10.750	12.500	0.563	273	318	14
25003-5350	23	10.629	11.811	0.590	270	300	15	21086-3686	53	10.750	12.500	0.563	273	318	14
24600-5445	26-L	10.629	11.811	0.630	270	300	16	21096-4524	53	10.750	12.500	0.625	273	318	16
25010-5881	23	10.629	12.119	0.750	270	308	19	21086-4524	53	10.750	12.500	0.625	273	318	16
25003-5881	23	10.629	12.119	0.750	270	308	19	24700-0102	59	10.750	12.500	0.625	273	318	16
25003-5862	23	10.629	12.251	0.625	270	311	16	24702-0102	59	10.750	12.500	0.625	273	318	16
26058-8655	57	10.630	12.205	0.630	270	310	16	24700-7320	59	10.750	12.500	0.875	273	318	22
24702-8655	59	10.630	12.205	0.630	270	310	16	21086-4029	53	10.750	12.625	0.750	273	321	19
24700-8655	59	10.630	12.205	0.630	270	310	16	25003-1623	23	10.750	12.688	0.578	273	322	15
24716-8655	59	10.630	12.205	0.630	270	310	16	24600-3687	26-L	10.750	12.750	0.563	273	324	14
21238-7769	64	10.630	12.126	0.688	270	308	17	21086-3687	53	10.750	12.750	0.563	273	324	14
25003-8655	23	10.630	12.205	0.630	270	310	16	24620-5465	26R1-L	10.750	12.750	0.625	273	324	16
24780-8655	59	10.630	12.205	0.630	270	310	16	24715-5465	59	10.750	12.750	0.625	273	324	16
24629-2965	26-L	10.630	12.205	0.787	270	310	20	24700-5465	59	10.750	12.750	0.625	273	324	16
24620-2965	26R1-L	10.630	12.205	0.787	270	310	20	25003-4030	23	10.750	12.750	0.750	273	324	19
25003-1027	23	10.630	12.362	0.787	270	314	20	21086-4030	53	10.750	12.750	0.750	273	324	19
25003-0205	23	10.688	11.742	0.625	271	298	16	24702-2970	59	10.750	12.750	0.750	273	324	19
25003-2791	23	10.688	12.250	0.625	271	311	16	26081-4030	87	10.750	12.750	0.750	273	324	19
24715-2620	59	10.688	12.500	0.625	271	318	16	26080-4030	87	10.750	12.750	0.750	273	324	19
24702-2620	59	10.688	12.500	0.625	271	318	16	26082-4030	87	10.750	12.750	0.750	273	324	19
25003-4854	23	10.688	12.688	0.750	271	322	19	24700-6501	59	10.750	12.750	0.812	273	324	21
25003-1049	23	10.710	12.511	0.625	272	318	16	25003-4031	23	10.750	12.750	0.813	273	324	21
25003-4994	23	10.728	11.728	0.500	272	298	13	25006-4031	23	10.750	12.750	0.813	273	324	21
25003-7598	23	10.750	11.750	0.500	273	298	13	21238-4031	64	10.750	12.750	0.813	273	324	21
25003-3682	23	10.750	11.750	0.563	273	298	14	21243-4031	64	10.750	12.750	0.813	273	324	21
24626-3682	26-L	10.750	11.750	0.563	273	298	14	21086-3688	53	10.750	12.750	0.875	273	324	22
24600-3682	26-L	10.750	11.750	0.563	273	298	14	24602-3689	26-L	10.750	12.750	1.000	273	324	25
21086-3682	53	10.750	11.750	0.563	273	298	14	21086-3689	53	10.750	12.750	1.000	273	324	25
21477-3682	53	10.750	11.750	0.563	273	298	14	21238-4026	64	10.750	13.250	0.812	273	337	21
21699-3682	53	10.750	11.750	0.563	273	298	14	24600-2148	26-L	10.787	11.969	0.591	274	304	15
24715-3682	59	10.750	11.750	0.563	273	298	14	24600-8830	26-L	10.787	12.250	0.688	274	311	17
24700-3682	59	10.750	11.750	0.563	273	298	14	25003-5808	23	10.826	11.826	0.590	275	300	15
21086-4519	53	10.750	11.875	0.625	273	302	16	25003-3571	23	10.826	12.000	0.590	275	305	15
21086-3684	53	10.750	12.000	0.563	273	305	14	24600-1040	26-L	10.826	12.000	0.590	275	305	15
25003-4161	23	10.750	12.000	0.594	273	305	15	25003-2350	23	10.827	12.205	0.591	275	310	15
25003-4520	23	10.750	12.000	0.625	273	305	16	25003-3401	23	10.827	11.811	0.492	275	300	12
25006-4520	23	10.750	12.000	0.625	273	305	16	24600-3722	26-L	10.827	12.205	0.591	275	310	15
24610-0100	26-L	10.750	12.000	0.625	273	305	16	24610-1196	26-L	10.866	11.866	0.625	276	301	16
21086-4520	53	10.750	12.000	0.625	273	305	16	21238-4027	64	10.875	12.375	0.688	276	314	17
24700-0100	59	10.750	12.000	0.625	273	305	16	25003-4032	23	10.875	12.375	0.750	276	314	19
21333-3729	143	10.750	12.062	0.781	273	306	20	25004-4032	23	10.875	12.375	0.750	276	314	19
24600-3685	26-L	10.750	12.250	0.562	273	311	14	25058-4032	25	10.875	12.375	0.750	276	314	19
21095-3685	53	10.750	12.250	0.562	273	311	14	24700-0104	59	10.875	12.375	0.750	276	314	19
25003-3685	23	10.750	12.250	0.563	273	311	14	21238-4028	64	10.875	12.500	0.688	276	318	17
21086-3685	53	10.750	12.250	0.563	273	311	14	25003-1982	23	10.875	12.875	0.500	276	327	13
24700-3685	59	10.750	12.250	0.563	273	311	14	25003-9535	23	10.875	12.875	0.578	276	327	15
25003-4522	23	10.750	12.250	0.625	273	311	16	25003-6416	23	10.875	12.875	0.813	276	327	21
21086-4522	53	10.750	12.250	0.625	273	311	16	25003-9932	23	10.938	12.188	0.813	278	310	21
21238-4023	64	10.750	12.250	0.688	273	311	17	25003-6087	23	10.938	12.438	0.625	278	316	16
25006-4024	23	10.750	12.250	0.750	273	311	19	25003-8874	23	10.938	12.500	0.625	278	318	16
25003-4024	23	10.750	12.250	0.750	273	311	19	25003-6504	23	10.938	12.938	0.750	278	329	19
21086-4024	53	10.750	12.250	0.750	273	311	19	25003-1246	23	10.984	12.165	0.591	279	309	15
21086-4025	53	10.750	12.375	0.562	273	314	14	25006-2104	23	10.985	12.993	0.748	279	330	19
25003-4484	23	10.750	12.375	0.625	273	314	16	24700-4858	59	10.993	12.402	0.788	279	315	20
25003-3686	23	10.750	12.500	0.563	273	318	14	25003-8761	23	11.000	12.000	0.375	279	305	10

All dimensions are in inches. Preferred sizes are indicated with **bold** type face. Sizes listed are for standard nitrile elements, except Models 25 and 62 which have PTFE elements. Other material available on inquiry only.

## Oil Seals by Model Number

Product Code	Model	Inches			MM			Product Code	Model	Inches			MM		
		ID	OD	Width	ID	OD	Width			ID	OD	Width	ID	OD	Width
25010-9693	23	11.000	12.000	0.500	279	305	13	24610-6395	26-L	11.000	13.000	0.750	279	330	19
25003-9693	23	11.000	12.000	0.500	279	305	13	25003-4036	23	11.000	13.000	0.813	279	330	21
25003-3691	23	11.000	12.000	0.625	279	305	16	25004-4036	23	11.000	13.000	0.813	279	330	21
24600-3691	26-L	11.000	12.000	0.625	279	305	16	21221-4036	64	11.000	13.000	0.813	279	330	21
24657-3691	26-L	11.000	12.000	0.625	279	305	16	21238-4036	64	11.000	13.000	0.813	279	330	21
21096-3691	53	11.000	12.000	0.625	279	305	16	21852-4036	64	11.000	13.000	0.813	279	330	21
21087-3691	53	11.000	12.000	0.625	279	305	16	21243-4036	64	11.000	13.000	0.813	279	330	21
21086-3691	53	11.000	12.000	0.625	279	305	16	22504-3119	64G1	11.000	13.000	0.938	279	330	24
24702-3691	59	11.000	12.000	0.625	279	305	16	24610-3694	26-L	11.000	13.000	1.000	279	330	25
22501-3392	53G1	11.000	12.000	0.750	279	305	19	22537-3694	53R1	11.000	13.000	1.000	279	330	25
25003-6393	23	11.000	12.125	0.547	279	308	14	22627-3694	53R2	11.000	13.000	1.000	279	330	25
21247-3135	64	11.000	12.250	0.563	279	311	14	21086-3694	53	11.000	13.000	1.000	279	330	25
21238-3135	64	11.000	12.250	0.563	279	311	14	21699-3694	53	11.000	13.000	1.000	279	330	25
24620-5018	26R1-L	11.000	12.250	0.609	279	311	15	21095-3694	53	11.000	13.000	1.000	279	330	25
25010-3692	23	11.000	12.250	0.625	279	311	16	25003-6964	23	11.023	12.023	0.500	280	305	13
25003-3692	23	11.000	12.250	0.625	279	311	16	24718-0982	59	11.024	12.205	0.630	280	310	16
25006-3692	23	11.000	12.250	0.625	279	311	16	24600-5233	26-L	11.024	12.441	0.709	280	316	18
25004-3692	23	11.000	12.250	0.625	279	311	16	24769-4028	59	11.024	12.598	0.709	280	320	18
24627-0106	26-L	11.000	12.250	0.625	279	311	16	24715-5926	59	11.024	13.386	1.102	280	340	28
24610-0106	26-L	11.000	12.250	0.625	279	311	16	24700-0108	59	11.024	12.197	0.629	280	310	16
21096-3692	53	11.000	12.250	0.625	279	311	16	24702-0108	59	11.024	12.197	0.629	280	310	16
21087-3692	53	11.000	12.250	0.625	279	311	16	25003-2582	23	11.024	12.205	0.630	280	310	16
21086-3692	53	11.000	12.250	0.625	279	311	16	25010-2582	23	11.024	12.205	0.630	280	310	16
24700-0106	59	11.000	12.250	0.625	279	311	16	24700-0982	59	11.024	12.205	0.630	280	310	16
24702-0106	59	11.000	12.250	0.625	279	311	16	25003-0890	23	11.024	12.205	0.787	280	310	20
24626-3720	26-L	11.000	12.250	0.688	279	311	17	25003-1962	23	11.024	12.520	0.709	280	318	18
24600-3720	26-L	11.000	12.250	0.688	279	311	17	25003-7848	23	11.024	12.598	0.630	280	320	16
24702-3720	59	11.000	12.250	0.688	279	311	17	21086-7848	53	11.024	12.598	0.630	280	320	16
25003-4450	23	11.000	12.375	0.750	279	314	19	24700-4028	59	11.024	12.598	0.709	280	320	18
24702-3692	59	11.000	12.375	0.750	279	314	19	25010-7391	23	11.024	12.598	0.787	280	320	20
25003-7716	23	11.000	12.500	0.500	279	318	13	25003-7391	23	11.024	12.598	0.787	280	320	20
25003-3693	23	11.000	12.500	0.625	279	318	16	25006-7391	23	11.024	12.598	0.787	280	320	20
24620-3693	26R1-L	11.000	12.500	0.625	279	318	16	24600-3695	26-L	11.024	12.598	0.787	280	320	20
21096-3693	53	11.000	12.500	0.625	279	318	16	24700-3695	59	11.024	12.598	0.787	280	320	20
21086-3693	53	11.000	12.500	0.625	279	318	16	21247-7391	64	11.024	12.598	0.787	280	320	20
24715-3693	59	11.000	12.500	0.625	279	318	16	21238-7391	64	11.024	12.598	0.787	280	320	20
24700-3693	59	11.000	12.500	0.625	279	318	16	21243-7391	64	11.024	12.598	0.787	280	320	20
21247-4611	64	11.000	12.500	0.688	279	318	17	26084-7391	88	11.024	12.598	0.787	280	320	20
21238-4611	64	11.000	12.500	0.688	279	318	17	25003-3507	23	11.024	12.756	0.787	280	324	20
21852-4611	64	11.000	12.500	0.688	279	318	17	25003-3724	23	11.024	12.795	0.812	280	325	21
25003-6394	23	11.000	12.500	0.750	279	318	19	25010-2440	23	11.024	12.795	0.866	280	325	22
22627-5927	53R2	11.000	12.500	1.375	279	318	35	25011-2440	23	11.024	12.796	0.866	280	325	22
25003-5006	23	11.000	12.625	0.625	279	321	16	25003-0897	23	11.024	12.992	0.610	280	330	15
25003-7204	23	11.000	12.625	0.750	279	321	19	21238-4039	64	11.024	13.386	0.813	280	340	21
25003-4867	23	11.000	12.750	0.750	279	324	19	24700-0109	59	11.024	13.386	0.984	280	340	25
24610-3468	26-L	11.000	12.750	0.750	279	324	19	25003-5303	23	11.027	12.500	0.625	280	318	16
25003-5462	23	11.000	12.813	0.625	279	325	16	25003-7878	23	11.029	12.029	0.375	280	306	10
25003-9149	23	11.000	12.875	0.812	279	327	21	25010-1465	23	11.031	12.031	0.500	280	306	13
25003-1905	23	11.000	13.000	0.500	279	330	13	25003-1465	23	11.031	12.031	0.500	280	306	13
25003-4002	23	11.000	13.000	0.625	279	330	16	25003-5724	23	11.031	12.031	0.625	280	306	16
24627-0107	26-L	11.000	13.000	0.625	279	330	16	25003-3695	23	11.062	12.250	0.750	281	311	19
24700-0107	59	11.000	13.000	0.625	279	330	16	21086-3696	53	11.062	12.500	0.750	281	318	19
21238-6034	64	11.000	13.000	0.688	279	330	17	21086-3698	53	11.062	13.000	0.750	281	330	19
25003-6395	23	11.000	13.000	0.750	279	330	19	21086-3695	53	11.063	12.250	0.750	281	311	19
25005-6395	24	11.000	13.000	0.750	279	330	19	25003-3261	23	11.063	12.313	0.625	281	313	16
24600-6395	26-L	11.000	13.000	0.750	279	330	19	25003-3696	23	11.063	12.500	0.750	281	318	19

All dimensions are in inches. Preferred sizes are indicated with **bold** type face.

Sizes listed are for standard nitrile elements, except Models 25 and 62 which have PTFE elements. Other material available on inquiry only.

## Oil Seals by Model Number

Product Code	Model	Inches			MM			Product Code	Model	Inches			MM		
		ID	OD	Width	ID	OD	Width			ID	OD	Width	ID	OD	Width
21086-3697	53	11.063	12.750	0.750	281	324	19	25058-4050	25	11.375	12.875	0.750	289	327	19
25003-5395	23	11.125	12.500	0.750	283	318	19	24700-0119	59	11.375	12.875	0.750	289	327	19
25006-5395	23	11.125	12.500	0.750	283	318	19	24702-0119	59	11.375	12.875	0.750	289	327	19
25003-1124	23	11.125	13.000	0.750	283	330	19	24700-0120	59	11.375	13.000	0.625	289	330	16
25003-4049	23	11.125	13.125	0.813	283	333	21	25003-5261	23	11.375	13.000	0.688	289	330	17
24700-5938	59	11.125	13.375	0.750	283	340	19	25003-4051	23	11.375	13.000	0.750	289	330	19
25003-3154	23	11.150	12.375	0.625	283	314	16	21086-4051	53	11.375	13.000	0.750	289	330	19
25003-0678	23	11.150	12.526	0.500	283	318	13	24700-4051	59	11.375	13.000	0.750	289	330	19
25003-0740	23	11.181	12.992	0.622	284	330	16	24742-4051	59	11.375	13.000	0.750	289	330	19
25003-6238	23	11.188	12.188	0.500	284	310	13	24707-4051	59	11.375	13.000	0.750	289	330	19
25003-4439	23	11.188	12.500	0.750	284	318	19	22627-6063	53R2	11.375	13.000	1.375	289	330	35
25003-1782	23	11.188	13.000	0.750	284	330	19	21238-4052	64	11.375	13.375	0.813	289	340	21
25003-5712	23	11.220	12.953	0.787	285	329	20	21840-4052	64	11.375	13.375	0.813	289	340	21
25001-0794	21	11.250	12.250	0.583	286	311	15	21243-4052	64	11.375	13.375	0.813	289	340	21
25003-9829	23	11.250	12.250	0.625	286	311	16	21086-3704	53	11.375	13.500	1.000	289	343	25
25135-1527	23	11.250	12.432	0.591	286	316	15	24700-0122	59	11.375	13.500	1.000	289	343	25
25003-6672	23	11.250	12.500	0.625	286	318	16	22987-4995	53F1	11.375	13.500	1.250	289	343	32
24700-0116	59	11.250	12.500	0.625	286	318	16	21086-4050	53	11.378	12.874	0.748	289	327	19
25003-7832	23	11.250	12.750	0.625	286	324	16	21432-2310	142	11.417	12.417	0.750	290	315	19
24643-7832	26E-L	11.250	12.750	0.625	286	324	16	21334-2898	143	11.417	12.729	0.781	290	323	20
24610-7832	26-L	11.250	12.750	0.625	286	324	16	25006-4433	23	11.417	12.992	0.630	290	330	16
24600-7832	26-L	11.250	12.750	0.625	286	324	16	25003-1031	23	11.417	12.992	0.787	290	330	20
24626-7832	26-L	11.250	12.750	0.625	286	324	16	25010-2940	23	11.417	13.150	0.787	290	334	20
24700-7832	59	11.250	12.750	0.625	286	324	16	25003-2940	23	11.417	13.150	0.787	290	334	20
25003-4527	23	11.250	12.750	0.688	286	324	17	24626-3696	26-L	11.417	13.150	0.787	290	334	20
21086-4527	53	11.250	12.750	0.688	286	324	17	24627-3696	26-L	11.417	13.150	0.787	290	334	20
21247-4527	64	11.250	12.750	0.688	286	324	17	25003-3014	23	11.417	13.189	0.812	290	335	21
21238-4527	64	11.250	12.750	0.688	286	324	17	25003-5882	23	11.417	13.417	0.750	290	341	19
21852-4527	64	11.250	12.750	0.688	286	324	17	25045-0932	23	11.417	13.417	0.812	290	341	21
21243-4527	64	11.250	12.750	0.688	286	324	17	25003-0932	23	11.417	13.417	0.813	290	341	21
25003-4046	23	11.250	12.750	0.750	286	324	19	24821-3305	EQUAL	11.417	13.780	1.181	290	350	30
25006-4046	23	11.250	12.750	0.750	286	324	19	24716-4042	59	11.417	12.992	0.630	290	330	16
21086-4046	53	11.250	12.750	0.750	286	324	19	25003-0416	23	11.417	12.992	0.709	290	330	18
21699-4046	53	11.250	12.750	0.750	286	324	19	24620-3886	26R1-L	11.417	12.992	0.787	290	330	20
24700-1904	59	11.250	12.750	0.750	286	324	19	24700-3100	59	11.417	13.780	0.984	290	350	25
25003-0420	23	11.250	13.250	0.625	286	337	16	25010-1926	23	11.418	13.386	0.748	290	340	19
24700-0117	59	11.250	13.250	0.625	286	337	16	25003-5719	23	11.422	12.921	0.750	290	328	19
21238-8778	64	11.250	13.250	0.688	286	337	17	24627-4702	26-L	11.422	12.922	0.750	290	328	19
25001-4047	21	11.250	13.250	0.813	286	337	21	21432-3511	142	11.438	12.438	0.750	291	316	19
25003-4047	23	11.250	13.250	0.813	286	337	21	24700-0124	59	11.438	13.000	0.688	291	330	17
24700-3613	59	11.250	13.250	0.813	286	337	21	25003-5851	23	11.471	13.471	0.750	291	342	19
21238-4047	64	11.250	13.250	0.813	286	337	21	25003-7639	23	11.500	12.375	0.375	292	314	10
21086-3703	53	11.250	13.250	1.000	286	337	25	25072-8962	23	11.500	12.500	0.375	292	318	10
21699-3703	53	11.250	13.250	1.000	286	337	25	25003-9094	23	11.500	12.500	0.500	292	318	13
24700-0118	59	11.250	13.500	0.875	286	343	22	24627-3850	26-L	11.500	12.500	0.500	292	318	13
21086-4048	53	11.250	13.500	1.000	286	343	25	24600-3850	26-L	11.500	12.500	0.500	292	318	13
24612-7292	26-L	11.313	12.813	0.750	287	325	19	25003-5642	23	11.500	12.625	0.625	292	321	16
25003-9942	23	11.335	12.520	0.500	288	318	13	25003-6621	23	11.500	12.750	0.500	292	324	13
25003-3072	23	11.339	12.839	0.750	288	326	19	25003-7263	23	11.500	12.750	0.625	292	324	16
25003-5014	23	11.344	12.594	0.625	288	320	16	24600-7263	26-L	11.500	12.750	0.625	292	324	16
25003-7437	23	11.365	12.625	0.625	289	321	16	24700-7263	59	11.500	12.750	0.625	292	324	16
25003-6549	23	11.375	12.375	0.500	289	314	13	24700-0125	59	11.500	12.875	0.688	292	327	17
25003-5397	23	11.375	12.625	0.625	289	321	16	25003-5012	23	11.500	12.875	0.750	292	327	19
25135-7608	23	11.375	12.875	0.625	289	327	16	25003-7219	23	11.500	13.000	0.500	292	330	13
25135-4050	23	11.375	12.875	0.750	289	327	19	25003-6687	23	11.500	13.000	0.625	292	330	16
25003-4050	23	11.375	12.875	0.750	289	327	19	24600-0126	26-L	11.500	13.000	0.625	292	330	16

All dimensions are in inches. Preferred sizes are indicated with **bold** type face. Sizes listed are for standard nitrile elements, except Models 25 and 62 which have PTFE elements. Other material available on inquiry only.

## Oil Seals by Model Number

Product Code	Model	Inches			MM			Product Code	Model	Inches			MM		
		ID	OD	Width	ID	OD	Width			ID	OD	Width	ID	OD	Width
24610-0126	26-L	11.500	13.000	0.625	292	330	16	24667-5633	26-L	11.653	12.835	0.630	296	326	16
24702-0126	59	11.500	13.000	0.625	292	330	16	24700-5802	59	11.688	13.000	0.750	297	330	19
25003-4057	23	11.500	13.000	0.688	292	330	17	25003-5776	23	11.688	13.188	0.625	297	335	16
21086-4057	53	11.500	13.000	0.688	292	330	17	24627-6615	26-L	11.688	13.188	0.750	297	335	19
24700-2569	59	11.500	13.000	0.688	292	330	17	25003-6840	23	11.688	13.250	0.625	297	337	16
21852-4057	64	11.500	13.000	0.688	292	330	17	25003-7874	23	11.732	12.606	0.375	298	320	10
21247-4057	64	11.500	13.000	0.688	292	330	17	25135-1522	23	11.750	12.734	0.492	298	323	12
21238-4057	64	11.500	13.000	0.688	292	330	17	25003-3239	23	11.750	13.000	0.813	298	330	21
21243-4057	64	11.500	13.000	0.688	292	330	17	25004-3239	23	11.750	13.000	0.813	298	330	21
29699-0023	GD	11.500	13.000	0.700	292	330	18	21333-3475	143	11.750	13.062	0.781	298	332	20
25010-4058	23	11.500	13.000	0.750	292	330	19	25003-9980	23	11.750	13.250	0.625	298	337	16
25045-4058	23	11.500	13.000	0.750	292	330	19	25004-9980	23	11.750	13.250	0.625	298	337	16
25003-4058	23	11.500	13.000	0.750	292	330	19	24626-0131	26-L	11.750	13.250	0.625	298	337	16
25006-4058	23	11.500	13.000	0.750	292	330	19	24600-0131	26-L	11.750	13.250	0.625	298	337	16
25004-4058	23	11.500	13.000	0.750	292	330	19	24715-0131	59	11.750	13.250	0.625	298	337	16
25058-4058	25	11.500	13.000	0.750	292	330	19	24700-0131	59	11.750	13.250	0.625	298	337	16
24610-2906	26-L	11.500	13.000	0.750	292	330	19	25003-4064	23	11.750	13.250	0.688	298	337	17
21086-4058	53	11.500	13.000	0.750	292	330	19	21086-4064	53	11.750	13.250	0.688	298	337	17
21095-4058	53	11.500	13.000	0.750	292	330	19	21852-4064	64	11.750	13.250	0.688	298	337	17
24700-2906	59	11.500	13.000	0.750	292	330	19	21773-4064	64	11.750	13.250	0.688	298	337	17
21702-5773	62	11.500	13.000	0.813	292	330	21	21238-4064	64	11.750	13.250	0.688	298	337	17
22897-5584	53T2	11.500	13.000	1.250	292	330	32	25003-4065	23	11.750	13.250	0.750	298	337	19
25003-2646	23	11.500	13.125	0.812	292	333	21	25006-4065	23	11.750	13.250	0.750	298	337	19
25003-4060	23	11.500	13.250	0.750	292	337	19	24610-4869	26-L	11.750	13.250	0.750	298	337	19
21086-4060	53	11.500	13.250	0.750	292	337	19	21086-4065	53	11.750	13.250	0.750	298	337	19
25003-1035	23	11.500	13.250	0.813	292	337	21	24752-4869	59G1	11.750	13.250	0.750	298	337	19
25003-4061	23	11.500	13.375	0.750	292	340	19	22503-3761	64G1	11.750	13.250	0.812	298	337	21
24700-0128	59	11.500	13.375	0.750	292	340	19	25003-6826	23	11.750	13.500	0.750	298	343	19
25003-3679	23	11.500	13.500	0.500	292	343	13	25003-9976	23	11.750	13.500	0.813	298	343	21
24700-0129	59	11.500	13.500	0.625	292	343	16	25003-2704	23	11.750	13.562	0.500	298	344	13
24702-0129	59	11.500	13.500	0.625	292	343	16	25003-9721	23	11.750	13.750	0.625	298	349	16
25003-4062	23	11.500	13.500	0.750	292	343	19	24700-0132	59	11.750	13.750	0.625	298	349	16
21086-4062	53	11.500	13.500	0.750	292	343	19	24060-9721	61	11.750	13.750	0.625	298	349	16
24700-0127	59	11.500	13.500	0.750	292	343	19	25003-6836	23	11.750	13.750	0.750	298	349	19
24702-6452	59	11.500	13.500	0.750	292	343	19	24648-2572	26R1-L	11.750	13.750	0.750	298	349	19
21247-4063	64	11.500	13.500	0.812	292	343	21	24627-2572	26-L	11.750	13.750	0.750	298	349	19
25003-4063	23	11.500	13.500	0.813	292	343	21	25003-8315	23	11.750	13.750	0.813	298	349	21
25004-4063	23	11.500	13.500	0.813	292	343	21	25006-8315	23	11.750	13.750	0.813	298	349	21
21255-4063	64	11.500	13.500	0.813	292	343	21	25004-8315	23	11.750	13.750	0.813	298	349	21
21238-4063	64	11.500	13.500	0.813	292	343	21	24610-3706	26-L	11.750	13.750	1.000	298	349	25
21243-4063	64	11.500	13.500	0.813	292	343	21	21086-3706	53	11.750	13.750	1.000	298	349	25
21852-4063	64	11.500	13.500	0.813	292	343	21	21699-3706	53	11.750	13.750	1.000	298	349	25
24612-3705	26-L	11.500	13.500	1.000	292	343	25	21086-3707	53-L	11.750	14.000	1.000	298	356	25
21086-3705	53	11.500	13.500	1.000	292	343	25	24700-0133	59	11.750	14.000	1.000	298	356	25
22627-9036	53R2	11.500	13.500	1.250	292	343	32	24782-4009	59	11.810	13.070	0.630	300	332	16
24610-3302	26-L	11.500	13.672	0.688	292	347	17	24783-4009	59	11.810	13.070	0.630	300	332	16
25003-8559	23	11.563	13.062	0.750	294	332	19	25003-5835	23	11.811	12.811	0.500	300	325	13
25003-5307	23	11.575	12.575	0.500	294	319	13	24700-4009	59	11.811	13.071	0.630	300	332	16
24715-6284	59	11.614	12.992	0.688	295	330	17	21333-4391	143	11.811	13.123	0.787	300	333	20
25003-7053	23	11.625	12.625	0.500	295	321	13	25003-6932	23	11.811	13.311	0.750	300	338	19
24700-1875	59	11.625	13.000	0.750	295	330	19	21096-7893	53	11.811	13.386	0.629	300	340	16
25003-8287	23	11.625	13.125	0.750	295	333	19	21086-7893	53	11.811	13.386	0.629	300	340	16
24700-0130	59	11.625	13.191	0.750	295	335	19	25003-7893	23	11.811	13.386	0.630	300	340	16
24610-6859	26-L	11.625	13.250	0.750	295	337	19	24610-0134	26-L	11.811	13.386	0.709	300	340	18
25003-5298	23	11.625	13.625	0.812	295	346	21	25006-4655	23	11.811	13.386	0.787	300	340	20
24610-4059	26-L	11.625	13.625	1.000	295	346	25	24608-4052	26R1-L	11.811	13.386	0.787	300	340	20

All dimensions are in inches. Preferred sizes are indicated with **bold** type face.

Sizes listed are for standard nitrile elements, except Models 25 and 62 which have PTFE elements. Other material available on inquiry only.

## Oil Seals by Model Number

Product Code	Model	Inches			MM			Product Code	Model	Inches			MM		
		ID	OD	Width	ID	OD	Width			ID	OD	Width	ID	OD	Width
24610-4052	26-L	11.811	13.386	0.788	300	340	20	25003-0954	23	12.000	13.250	0.750	305	337	19
24756-5277	59	11.811	13.543	0.661	300	344	17	25010-4707	23	12.000	13.500	0.625	305	343	16
24742-5277	59	11.811	13.543	0.661	300	344	17	25003-4707	23	12.000	13.500	0.625	305	343	16
24743-5277	59	11.811	13.543	0.661	300	344	17	25006-4707	23	12.000	13.500	0.625	305	343	16
25006-4602	23	11.811	13.543	0.787	300	344	20	24610-0140	26-L	12.000	13.500	0.625	305	343	16
25004-4602	23	11.811	13.543	0.787	300	344	20	24715-0140	59	12.000	13.500	0.625	305	343	16
24600-4056	26-L	11.811	13.543	0.787	300	344	20	24700-0140	59	12.000	13.500	0.625	305	343	16
24700-4056	59	11.811	13.543	0.787	300	344	20	24821-0140	EQUAL	12.000	13.500	0.625	305	343	16
25003-8525	23	11.811	13.543	0.807	300	344	20	24608-3708	26R1-L	12.000	13.500	0.653	305	343	17
25006-8525	23	11.811	13.543	0.807	300	344	20	21221-4612	64	12.000	13.500	0.687	305	343	17
26188-8525	88	11.811	13.543	0.807	300	344	20	25003-4612	23	12.000	13.500	0.688	305	343	17
25010-2443	23	11.811	13.583	0.866	300	345	22	24626-4612	26-L	12.000	13.500	0.688	305	343	17
24620-1037	26R1-L	11.811	13.583	0.866	300	345	22	24600-4612	26-L	12.000	13.500	0.688	305	343	17
25003-3069	23	11.811	13.811	0.750	300	351	19	24700-4612	59	12.000	13.500	0.688	305	343	17
25003-5352	23	11.811	12.992	0.591	300	330	15	21247-4612	64	12.000	13.500	0.688	305	343	17
25003-5446	23-L	11.811	13.189	0.709	300	335	18	21773-4612	64	12.000	13.500	0.688	305	343	17
21086-7892	53	11.811	13.386	0.630	300	340	16	21222-4612	64	12.000	13.500	0.688	305	343	17
24700-6343	59	11.811	13.386	0.630	300	340	16	21227-4612	64	12.000	13.500	0.688	305	343	17
24700-0134	59	11.811	13.386	0.709	300	340	18	21238-4612	64	12.000	13.500	0.688	305	343	17
25003-4655	23	11.811	13.386	0.787	300	340	20	21243-4612	64	12.000	13.500	0.688	305	343	17
24715-4052	59	11.811	13.386	0.787	300	340	20	25003-4067	23	12.000	13.500	0.750	305	343	19
25003-4602	23	11.811	13.543	0.787	300	344	20	25006-4067	23	12.000	13.500	0.750	305	343	19
24609-4056	26-L	11.811	13.543	0.787	300	344	20	24610-4067	26-L	12.000	13.500	0.750	305	343	19
26088-8525	88-L	11.811	13.543	0.807	300	344	21	21087-4067	53	12.000	13.500	0.750	305	343	19
24610-1037	26-L	11.811	13.583	0.866	300	345	22	21086-4067	53	12.000	13.500	0.750	305	343	19
25003-4881	23	11.811	13.780	0.748	300	350	19	21477-4067	53	12.000	13.500	0.750	305	343	19
25010-9491	23	11.813	13.313	0.750	300	338	19	24754-4067	59G1	12.000	13.500	0.750	305	343	19
25003-9491	23	11.813	13.313	0.750	300	338	19	25003-5670	23	12.000	13.500	0.813	305	343	21
24627-6411	26-L	11.813	13.313	0.750	300	338	19	22537-5950	53R1	12.000	13.500	1.313	305	343	33
24610-6411	26-L	11.813	13.313	0.750	300	338	19	24700-0141	59	12.000	13.625	0.625	305	346	16
25003-0697	23	11.813	13.813	0.813	300	351	21	25003-4068	23	12.000	13.625	0.750	305	346	19
24700-0137	59	11.813	14.000	0.750	300	356	19	24626-4068	26-L	12.000	13.625	0.750	305	346	19
25003-6705	23	11.875	12.875	0.500	302	327	13	24627-4068	26-L	12.000	13.625	0.750	305	346	19
24610-2939	26-L	11.875	13.375	0.625	302	340	16	24600-4068	26-L	12.000	13.625	0.750	305	346	19
25003-6328	23	11.875	13.375	0.750	302	340	19	21096-4068	53	12.000	13.625	0.750	305	346	19
25003-9749	23	11.875	13.875	0.750	302	352	19	21086-4068	53	12.000	13.625	0.750	305	346	19
25003-6719	23	11.906	13.156	0.625	302	334	16	22627-7326	53R2	12.000	13.625	1.438	305	346	37
25004-6719	23	11.906	13.156	0.625	302	334	16	25003-3701	23	12.000	13.750	0.688	305	349	17
25003-4604	23	11.938	13.438	0.625	303	341	16	24626-0985	26-L	12.000	13.750	0.688	305	349	17
25003-4452	23	11.938	13.760	0.750	303	350	19	24600-0985	26-L	12.000	13.750	0.688	305	349	17
25006-4452	23	11.938	13.760	0.750	303	350	19	21852-3701	64	12.000	13.750	0.688	305	349	17
25007-3410	25	11.950	13.500	0.625	304	343	16	25003-4911	23	12.000	13.750	0.750	305	349	19
25003-4785	23	11.962	12.688	0.500	304	322	13	25003-0623	23	12.000	13.875	0.437	305	352	11
25003-1310	23	12.000	12.875	0.375	305	327	10	25003-0949	23	12.000	13.875	0.500	305	352	13
24610-2538	26-L	12.000	13.000	0.500	305	330	13	22627-4884	53R2	12.000	13.875	1.313	305	352	33
21432-8107	142	12.000	13.000	0.750	305	330	19	25003-9148	23	12.000	13.938	0.813	305	354	21
25003-3824	23	12.000	13.125	0.625	305	333	16	25003-3853	23-L	12.000	14.000	0.625	305	356	16
21432-9707	142	12.000	13.125	1.250	305	333	32	25006-3853	23-L	12.000	14.000	0.625	305	356	16
21443-9707	142	12.000	13.125	1.250	305	333	32	24626-3853	26-L	12.000	14.000	0.625	305	356	16
21432-2986	142	12.000	13.125	1.313	305	333	33	24600-3853	26-L	12.000	14.000	0.625	305	356	16
21432-7445	142	12.000	13.125	1.375	305	333	35	24700-3853	59	12.000	14.000	0.625	305	356	16
25006-7306	23	12.000	13.250	0.625	305	337	16	24702-3853	59	12.000	14.000	0.625	305	356	16
25010-7306	23	12.000	13.250	0.625	305	337	16	24060-3853	61	12.000	14.000	0.625	305	356	16
25003-7306	23	12.000	13.250	0.625	305	337	16	21238-5838	64-L	12.000	14.000	0.688	305	356	17
25004-7306	23	12.000	13.250	0.625	305	337	16	25003-4071	23-L	12.000	14.000	0.750	305	356	19
24700-0139	59	12.000	13.250	0.625	305	337	16	25006-4071	23-L	12.000	14.000	0.750	305	356	19

All dimensions are in inches. Preferred sizes are indicated with **bold** type face.  
 Sizes listed are for standard nitrile elements, except Models 25 and 62 which have PTFE elements. Other material available on inquiry only.

## Oil Seals by Model Number

Product Code	Model	Inches			MM			Product Code	Model	Inches			MM		
		ID	OD	Width	ID	OD	Width			ID	OD	Width	ID	OD	Width
24620-4071	26R1-L	12.000	14.000	0.750	305	356	19	24700-5693	59	12.205	14.173	0.984	310	360	25
24627-4071	26-L	12.000	14.000	0.750	305	356	19	25003-2454	23	12.205	13.937	0.787	310	354	20
24610-4071	26-L	12.000	14.000	0.750	305	356	19	26081-2454	87	12.205	13.937	0.787	310	354	20
21096-4071	53-L	12.000	14.000	0.750	305	356	19	26095-2454	87	12.205	13.937	0.787	310	354	20
21086-4071	53-L	12.000	14.000	0.750	305	356	19	25003-6441	23	12.208	13.703	0.750	310	348	19
21238-4071	64-L	12.000	14.000	0.750	305	356	19	25003-4069	23	12.250	13.375	0.625	311	340	16
21243-4071	64-L	12.000	14.000	0.750	305	356	19	25003-3712	23	12.250	13.500	0.625	311	343	16
26086-4071	88-L	12.000	14.000	0.750	305	356	19	25003-0599	23	12.250	13.500	0.750	311	343	19
26088-4071	88-L	12.000	14.000	0.750	305	356	19	24600-4041	26-L	12.250	13.750	0.625	311	349	16
26588-4071	88-L	12.000	14.000	0.750	305	356	19	24700-4041	59	12.250	13.750	0.625	311	349	16
25006-0681	23-L	12.000	14.000	0.770	305	356	20	21247-4613	64	12.250	13.750	0.687	311	349	17
21852-4072	64-L	12.000	14.000	0.812	305	356	21	21852-4613	64	12.250	13.750	0.688	311	349	17
25010-4072	23-L	12.000	14.000	0.813	305	356	21	21255-4613	64	12.250	13.750	0.688	311	349	17
25003-4072	23-L	12.000	14.000	0.813	305	356	21	21238-4613	64	12.250	13.750	0.688	311	349	17
25006-4072	23-L	12.000	14.000	0.813	305	356	21	21773-4613	64	12.250	13.750	0.688	311	349	17
24715-4072	59	12.000	14.000	0.813	305	356	21	21957-4613	64	12.250	13.750	0.688	311	349	17
24700-4072	59	12.000	14.000	0.813	305	356	21	21243-4613	64	12.250	13.750	0.688	311	349	17
21702-4072	62	12.000	14.000	0.813	305	356	21	25003-4074	23	12.250	13.750	0.750	311	349	19
21238-4072	64-L	12.000	14.000	0.813	305	356	21	25004-4074	23	12.250	13.750	0.750	311	349	19
24700-2980	59	12.000	14.000	0.938	305	356	24	24600-4074	26-L	12.250	13.750	0.750	311	349	19
21619-3709	51-L	12.000	14.000	1.000	305	356	25	24610-4074	26-L	12.250	13.750	0.750	311	349	19
21486-3709	51-L	12.000	14.000	1.000	305	356	25	21086-4074	53	12.250	13.750	0.750	311	349	19
21022-3709	51-L	12.000	14.000	1.000	305	356	25	24702-4528	59	12.250	13.813	0.625	311	351	16
21017-3709	51-L	12.000	14.000	1.000	305	356	25	25003-4895	23	12.250	13.821	0.750	311	351	19
21086-3709	53-L	12.000	14.000	1.000	305	356	25	25003-3137	23	12.250	13.875	0.625	311	352	16
21091-3709	53-L	12.000	14.000	1.000	305	356	25	25003-2472	23-L	12.250	14.000	0.625	311	356	16
22987-7392	53F1-L	12.000	14.000	1.250	305	356	32	21238-4055	64-L	12.250	14.000	0.688	311	356	17
22897-7392	53T2-L	12.000	14.000	1.250	305	356	32	24600-4232	26-L	12.250	14.000	0.750	311	356	19
22634-7283	53R2-L	12.000	14.000	1.375	305	356	35	24700-1869	59	12.250	14.000	0.875	311	356	22
21086-3710	53-L	12.000	14.250	1.000	305	362	25	24700-0152	59	12.250	14.250	0.625	311	362	16
24715-5603	59	12.000	14.360	0.750	305	365	19	25003-6829	23-L	12.250	14.250	0.750	311	362	19
21238-3702	64-L	12.000	14.750	0.813	305	375	21	26086-6829	88-L	12.250	14.250	0.750	311	362	19
29699-0002	GD	12.000	16.875	2.300	305	429	58	26088-6829	88-L	12.250	14.250	0.750	311	362	19
25003-7250	23	12.062	13.563	0.750	306	345	19	26090-6829	88-L	12.250	14.250	0.750	311	362	19
25001-4441	21	12.063	13.625	0.750	306	346	19	21221-4075	64-L	12.250	14.250	0.812	311	362	21
25003-1781	23	12.125	13.125	0.500	308	333	13	25003-4075	23-L	12.250	14.250	0.813	311	362	21
25003-2395	23	12.125	13.375	0.750	308	340	19	24700-1868	59	12.250	14.250	0.813	311	362	21
25003-7570	23	12.125	13.625	0.750	308	346	19	21247-4075	64-L	12.250	14.250	0.813	311	362	21
24700-5581	59	12.125	13.875	0.687	308	352	17	21773-4075	64-L	12.250	14.250	0.813	311	362	21
24700-0146	59	12.125	13.875	0.750	308	352	19	21238-4075	64-L	12.250	14.250	0.813	311	362	21
24700-0147	59	12.125	14.000	0.875	308	356	22	21243-4075	64-L	12.250	14.250	0.813	311	362	21
21086-4073	53-L	12.125	14.000	1.000	308	356	25	21852-4075	64-L	12.250	14.250	0.813	311	362	21
25003-6484	23-L	12.125	14.125	0.750	308	359	19	21086-3713	53-L	12.250	14.250	1.000	311	362	25
25003-0990	23	12.147	13.688	0.625	309	348	16	26080-1040	87-L	12.250	14.250	1.250	311	362	32
24700-0148	59	12.188	13.438	0.625	310	341	16	26082-1040	87-L	12.250	14.250	1.250	311	362	32
25003-6253	23	12.188	13.688	0.625	310	348	16	24600-8814	26-L	12.283	13.750	0.688	312	349	17
25003-0691	23-L	12.188	14.000	0.750	310	356	19	24600-5483	26-L	12.312	13.937	0.750	313	354	19
21432-1244	142	12.204	13.204	0.750	310	335	19	24610-5483	26-L	12.312	13.937	0.750	313	354	19
21443-1244	142	12.204	13.204	0.750	310	335	19	25003-5558	23	12.313	13.938	0.750	313	354	19
25003-5340	23	12.204	13.385	0.590	310	340	15	25003-0677	23	12.318	13.694	0.500	313	348	13
24743-0999	59	12.204	13.780	0.787	310	350	20	24702-5444	59	12.362	13.976	0.787	314	355	20
24707-0999	59	12.204	13.780	0.787	310	350	20	24715-3454	59	12.366	14.500	0.750	314	368	19
25003-5536	23	12.205	13.189	0.500	310	335	13	24618-2007	26-L	12.375	13.375	0.500	314	340	13
21238-4232	64	12.205	13.780	0.689	310	350	18	21432-1715	142	12.375	13.500	1.250	314	343	32
24718-3408	59	12.205	13.780	0.709	310	350	18	25003-9301	23	12.375	13.875	0.625	314	352	16
24700-0999	59	12.205	13.780	0.787	310	350	20	24700-0153	59	12.375	13.875	0.688	314	352	17

All dimensions are in inches. Preferred sizes are indicated with **bold** type face.

Sizes listed are for standard nitrile elements, except Models 25 and 62 which have PTFE elements. Other material available on inquiry only.



**Oil Seals by Model Number**

Product Code	Model	Inches			MM			Product Code	Model	Inches			MM		
		ID	OD	Width	ID	OD	Width			ID	OD	Width	ID	OD	Width
21247-4076	64	12.375	13.875	0.688	314	352	17	21238-4082	64-L	12.500	14.500	0.750	318	368	19
21238-4076	64	12.375	13.875	0.688	314	352	17	25003-4083	23-L	12.500	14.500	0.813	318	368	21
21852-4076	64	12.375	13.875	0.688	314	352	17	21247-4083	64-L	12.500	14.500	0.813	318	368	21
21243-4076	64	12.375	13.875	0.688	314	352	17	21238-4083	64-L	12.500	14.500	0.813	318	368	21
25003-4077	23	12.375	13.875	0.750	314	352	19	21852-4083	64-L	12.500	14.500	0.813	318	368	21
21086-4077	53	12.375	13.875	0.750	314	352	19	24627-4355	26-L	12.500	14.500	1.000	318	368	25
22627-4751	53R2	12.375	13.875	1.438	314	352	37	24610-4355	26-L	12.500	14.500	1.000	318	368	25
21238-4056	64-L	12.375	14.000	0.688	314	356	17	21086-3714	53-L	12.500	14.500	1.000	318	368	25
25003-3982	23-L	12.375	14.125	0.812	314	359	21	22627-9419	53R2-L	12.500	14.500	1.250	318	368	32
21238-4097	64-L	12.375	14.375	0.688	314	365	17	22897-6527	53T2-L	12.500	14.500	1.313	318	368	33
25003-9928	23-L	12.380	14.380	0.813	314	365	21	21086-4085	53-L	12.500	14.750	1.000	318	375	25
24702-4029	59	12.402	13.976	0.709	315	355	18	24700-0158	59	12.500	14.750	1.000	318	375	25
24700-4029	59	12.402	13.976	0.709	315	355	18	24702-0159	59	12.500	15.000	0.812	318	381	21
25003-1108	23-L	12.402	14.173	0.787	315	360	20	21852-4084	64-L	12.500	15.000	0.813	318	381	21
25003-5953	23	12.406	13.906	0.750	315	353	19	21238-4084	64-L	12.500	15.000	0.813	318	381	21
25003-9396	23-L	12.438	14.000	0.750	316	356	19	24700-0160	59	12.565	14.063	0.750	319	357	19
25015-9396	23-L	12.438	14.000	0.750	316	356	19	24700-0161	59	12.590	14.125	1.000	320	359	25
25003-1173	23-L	12.438	14.375	0.813	316	365	21	25003-5576	23	12.598	13.583	0.500	320	345	13
25003-1176	23-L	12.438	14.438	0.813	316	367	21	25004-5667	23-L	12.598	14.095	0.750	320	358	19
24626-5496	26-L	12.441	14.173	0.787	316	360	20	25003-4234	23-L	12.598	14.173	0.375	320	360	10
25003-1984	23	12.500	13.375	0.500	318	340	13	25003-1113	23-L	12.598	14.173	0.708	320	360	18
25003-5114	23	12.500	13.500	0.500	318	343	13	24610-1966	26-L	12.598	14.173	0.709	320	360	18
24600-5114	26-L	12.500	13.500	0.500	318	343	13	25003-1712	23-L	12.598	14.173	0.748	320	360	19
25003-8229	23	12.500	13.750	0.625	318	349	16	25003-1103	23-L	12.598	14.173	0.787	320	360	20
25006-8229	23	12.500	13.750	0.625	318	349	16	24626-4397	26-L	12.598	14.173	0.787	320	360	20
24702-0157	59	12.500	13.750	0.625	318	349	16	24702-4397	59	12.598	14.173	0.787	320	360	20
24700-0157	59	12.500	13.750	0.625	318	349	16	24715-4397	59	12.598	14.173	0.787	320	360	20
21333-2979	143	12.500	13.812	0.781	318	351	20	24700-4397	59	12.598	14.173	0.787	320	360	20
25003-8998	23	12.500	13.906	0.750	318	353	19	25006-2911	23-L	12.598	14.330	0.787	320	364	20
25003-4496	23-L	12.500	14.000	0.625	318	356	16	25004-2911	23-L	12.598	14.330	0.787	320	364	20
25138-4496	23-L	12.500	14.000	0.625	318	356	16	24600-3721	26-L	12.598	14.331	0.787	320	364	20
24600-4496	26-L	12.500	14.000	0.625	318	356	16	24700-0162	59	12.598	13.780	0.630	320	350	16
24700-4496	59	12.500	14.000	0.625	318	356	16	25003-5667	23-L	12.598	14.094	0.748	320	358	19
24627-4510	26-L	12.500	14.000	0.653	318	356	17	24700-1966	59	12.598	14.173	0.709	320	360	18
25003-4079	23-L	12.500	14.000	0.688	318	356	17	24600-4397	26-L	12.598	14.173	0.787	320	360	20
24700-2936	59	12.500	14.000	0.688	318	356	17	24610-4397	26-L	12.598	14.173	0.787	320	360	20
21238-4079	64-L	12.500	14.000	0.688	318	356	17	24772-5925	59	12.598	14.173	0.984	320	360	25
21243-4079	64-L	12.500	14.000	0.688	318	356	17	24715-5925	59	12.598	14.173	0.984	320	360	25
26088-4079	88-L	12.500	14.000	0.688	318	356	17	25003-2911	23-L	12.598	14.331	0.787	320	364	20
25010-4080	23-L	12.500	14.000	0.750	318	356	19	25003-1182	23-L	12.599	14.252	0.815	320	362	21
25003-4080	23-L	12.500	14.000	0.750	318	356	19	25003-7135	23	12.625	13.875	0.625	321	352	16
25006-4080	23-L	12.500	14.000	0.750	318	356	19	25003-4480	23-L	12.625	14.000	0.750	321	356	19
24610-4080	26-L	12.500	14.000	0.750	318	356	19	21852-4081	64-L	12.625	14.125	0.688	321	359	17
21086-4080	53-L	12.500	14.000	0.750	318	356	19	21216-4081	64-L	12.625	14.125	0.688	321	359	17
25003-8589	23-L	12.500	14.062	0.750	318	357	19	21238-4081	64-L	12.625	14.125	0.688	321	359	17
25003-3780	23-L	12.500	14.250	0.750	318	362	19	25003-4086	23-L	12.625	14.125	0.750	321	359	19
25003-1304	23-L	12.500	14.375	0.750	318	365	19	21238-3716	64-L	12.625	14.500	0.687	321	368	17
24656-3909	26HR-L	12.500	14.400	0.750	318	366	19	21852-3716	64-L	12.625	14.500	0.687	321	368	17
25003-4082	23-L	12.500	14.500	0.750	318	368	19	25003-7279	23-L	12.625	14.625	0.750	321	371	19
25004-4082	23-L	12.500	14.500	0.750	318	368	19	21086-3715	53-L	12.625	14.625	1.000	321	371	25
24627-4082	26-L	12.500	14.500	0.750	318	368	19	25003-5669	23-L	12.688	14.688	0.813	322	373	21
24600-4082	26-L	12.500	14.500	0.750	318	368	19	21086-3717	53-L	12.688	14.750	1.000	322	375	25
24602-4082	26-L	12.500	14.500	0.750	318	368	19	21699-3717	53-L	12.688	14.750	1.000	322	375	25
24612-4082	26-L	12.500	14.500	0.750	318	368	19	25003-7600	23	12.750	13.750	0.500	324	349	13
24700-4082	59	12.500	14.500	0.750	318	368	19	25003-3224	23-L	12.750	14.000	0.500	324	356	13
								25003-4788	23-L	12.750	14.000	0.750	324	356	19

All dimensions are in inches. Preferred sizes are indicated with **bold** type face. Sizes listed are for standard nitrile elements, except Models 25 and 62 which have PTFE elements. Other material available on inquiry only.

## Oil Seals by Model Number

Product Code	Model	Inches			MM			Product Code	Model	Inches			MM		
		ID	OD	Width	ID	OD	Width			ID	OD	Width	ID	OD	Width
25003-4088	23-L	12.750	14.250	0.625	324	362	16	24700-0174	59	12.992	14.567	0.709	330	370	18
25003-4089	23-L	12.750	14.250	0.688	324	362	17	25003-3170	23-L	12.992	14.724	0.748	330	374	19
21852-4089	64-L	12.750	14.250	0.688	324	362	17	25003-4630	23-L	12.992	14.724	0.787	330	374	20
25010-5942	23-L	12.750	14.250	0.750	324	362	19	24715-5525	59	12.992	14.724	0.787	330	374	20
24626-5942	26-L	12.750	14.250	0.750	324	362	19	24715-6121	59	12.992	14.961	0.866	330	380	22
25003-2185	23-L	12.750	14.250	0.812	324	362	21	24700-1000	59	12.992	15.354	0.984	330	390	25
25003-2319	23-L	12.750	14.482	0.787	324	368	20	25011-8576	23-L	13.000	14.000	0.500	330	356	13
25003-5917	23-L	12.750	14.500	0.750	324	368	19	25003-8576	23-L	13.000	14.000	0.500	330	356	13
25003-0617	23-L	12.750	14.688	0.813	324	373	21	25010-4969	23-L	13.000	14.125	0.547	330	359	14
21238-7652	64-L	12.750	14.750	0.688	324	375	17	25003-4969	23-L	13.000	14.125	0.547	330	359	14
25001-6396	21-L	12.750	14.750	0.750	324	375	19	21432-7729	142-L	13.000	14.125	1.250	330	359	32
25003-6396	23-L	12.750	14.750	0.750	324	375	19	21432-0812	142-L	13.000	14.125	1.375	330	359	35
25006-6396	23-L	12.750	14.750	0.750	324	375	19	21443-0812	142-L	13.000	14.125	1.375	330	359	35
24700-0169	59	12.750	14.750	0.750	324	375	19	25003-4770	23-L	13.000	14.250	0.625	330	362	16
24702-0169	59	12.750	14.750	0.750	324	375	19	24715-4234	59	13.000	14.250	0.688	330	362	17
25003-2497	23-L	12.750	14.750	0.812	324	375	21	21333-2817	143	13.000	14.312	0.781	330	364	20
24627-4090	26-L	12.750	14.750	1.000	324	375	25	25010-7805	23-L	13.000	14.500	0.625	330	368	16
24610-4090	26-L	12.750	14.750	1.000	324	375	25	25003-7805	23-L	13.000	14.500	0.625	330	368	16
24700-4090	59	12.750	14.750	1.000	324	375	25	25006-7805	23-L	13.000	14.500	0.625	330	368	16
24700-0168	59	12.756	14.252	0.630	324	362	16	24627-7805	26-L	13.000	14.500	0.625	330	368	16
21238-4089	64-L	12.756	14.252	0.709	324	362	18	24610-7805	26-L	13.000	14.500	0.625	330	368	16
25003-5942	23-L	12.756	14.252	0.748	324	362	19	24700-7805	59	13.000	14.500	0.625	330	368	16
24600-5942	26-L	12.756	14.252	0.748	324	362	19	25003-4093	23-L	13.000	14.500	0.688	330	368	17
25003-8261	23	12.795	13.669	0.375	325	347	10	25006-4093	23-L	13.000	14.500	0.688	330	368	17
25003-3186	23-L	12.795	14.370	0.807	325	365	20	25004-4093	23-L	13.000	14.500	0.688	330	368	17
25003-3209	23-L	12.795	14.370	0.630	325	365	16	24600-4093	26-L	13.000	14.500	0.688	330	368	17
25006-3209	23-L	12.795	14.370	0.630	325	365	16	24610-4093	26-L	13.000	14.500	0.688	330	368	17
24715-4058	59	12.795	14.370	0.630	325	365	16	21086-4093	53-L	13.000	14.500	0.688	330	368	17
24716-4058	59	12.795	14.370	0.630	325	365	16	24700-4093	59	13.000	14.500	0.688	330	368	17
24700-4058	59	12.796	14.370	0.630	325	365	16	24702-4093	59	13.000	14.500	0.688	330	368	17
25006-1016	23-L	12.813	14.813	0.750	325	376	19	21247-4093	64-L	13.000	14.500	0.688	330	368	17
21238-5404	64-L	12.874	15.000	0.827	327	381	21	21255-4093	64-L	13.000	14.500	0.688	330	368	17
25003-1960	23	12.875	13.875	0.500	327	352	13	21221-4093	64-L	13.000	14.500	0.688	330	368	17
25003-5939	23-L	12.875	14.375	0.750	327	365	19	21238-4093	64-L	13.000	14.500	0.688	330	368	17
25003-6782	23-L	12.875	14.750	0.813	327	375	21	21840-4093	64-L	13.000	14.500	0.688	330	368	17
21086-3718	53-L	12.875	14.750	1.000	327	375	25	21243-4093	64-L	13.000	14.500	0.688	330	368	17
21699-3718	53-L	12.875	14.750	1.000	327	375	25	21852-4093	64-L	13.000	14.500	0.688	330	368	17
24700-3718	59	12.875	14.750	1.000	327	375	25	25001-4094	21-L	13.000	14.500	0.750	330	368	19
25003-8115	23-L	12.875	14.875	0.750	327	378	19	25003-4094	23-L	13.000	14.500	0.750	330	368	19
25005-9937	24	12.875	15.000	0.750	327	381	19	25006-4094	23-L	13.000	14.500	0.750	330	368	19
24700-0173	59	12.875	15.500	0.875	327	394	22	25004-4094	23-L	13.000	14.500	0.750	330	368	19
25003-8511	23-L	12.906	14.906	0.750	328	379	19	21087-4094	53-L	13.000	14.500	0.750	330	368	19
25003-0203	23-L	12.938	14.250	0.625	329	362	16	21086-4094	53-L	13.000	14.500	0.750	330	368	19
24600-5341	26-L	12.992	14.173	0.590	330	360	15	24702-2496	59	13.000	14.500	0.750	330	368	19
25003-9996	23-L	12.992	14.566	0.708	330	370	18	25003-0818	23-L	13.000	14.500	0.812	330	368	21
24707-0174	59	12.992	14.566	0.708	330	370	18	22505-0818	64G1-L	13.000	14.500	0.813	330	368	21
24629-3235	26-L	12.992	14.567	0.482	330	370	12	22987-3890	53F1-L	13.000	14.500	1.000	330	368	25
24600-5989	26-L	12.992	14.567	0.787	330	370	20	25135-1531	23-L	13.000	14.574	0.787	330	370	20
25004-4630	23-L	12.992	14.724	0.787	330	374	20	25003-1242	23-L	13.000	14.606	0.703	330	371	18
24700-5525	59	12.992	14.724	0.787	330	374	20	25003-4095	23-L	13.000	14.625	0.750	330	371	19
25003-3711	23-L	12.992	14.961	0.812	330	380	21	24600-4095	26-L	13.000	14.625	0.750	330	371	19
25010-2445	23-L	12.992	14.961	0.866	330	380	22	21086-4095	53-L	13.000	14.625	0.750	330	371	19
24743-1000	59	12.992	15.354	0.984	330	390	25	24700-4095	59	13.000	14.625	0.750	330	371	19
24707-1000	59	12.992	15.354	0.984	330	390	25	25003-9255	23-L	13.000	14.750	0.500	330	375	13
25003-0590	23-L	12.992	14.173	0.394	330	360	10	25003-7547	23-L	13.000	14.750	0.750	330	375	19
25003-5341	23-L	12.992	14.173	0.591	330	360	15	25006-7547	23-L	13.000	14.750	0.750	330	375	19

All dimensions are in inches. Preferred sizes are indicated with **bold** type face.  
 Sizes listed are for standard nitrile elements, except Models 25 and 62 which have PTFE elements. Other material available on inquiry only.

## Oil Seals by Model Number

Product Code	Model	Inches			MM			Product Code	Model	Inches			MM		
		ID	OD	Width	ID	OD	Width			ID	OD	Width	ID	OD	Width
25003-6168	23-L	13.000	14.825	0.813	330	377	21	21086-4103	53-L	13.250	14.875	0.750	337	378	19
21238-4096	64-L	13.000	14.875	0.688	330	378	17	24715-0179	59	13.250	14.875	0.750	337	378	19
24700-0176	59	13.000	14.875	0.875	330	378	22	24700-0179	59	13.250	14.875	0.750	337	378	19
25003-9598	23-L	13.000	15.000	0.625	330	381	16	21238-7169	64-L	13.250	15.000	0.687	337	381	17
25003-4098	23-L	13.000	15.000	0.750	330	381	19	24700-0180	59	13.250	15.000	0.750	337	381	19
25005-4098	24-L	13.000	15.000	0.750	330	381	19	21238-6294	64-L	13.250	15.250	0.688	337	387	17
24626-4098	26-L	13.000	15.000	0.750	330	381	19	25010-6264	23-L	13.250	15.250	0.750	337	387	19
24600-4098	26-L	13.000	15.000	0.750	330	381	19	25003-6264	23-L	13.250	15.250	0.750	337	387	19
24610-4098	26-L	13.000	15.000	0.750	330	381	19	25006-6264	23-L	13.250	15.250	0.750	337	387	19
21086-4098	53-L	13.000	15.000	0.750	330	381	19	25004-6264	23-L	13.250	15.250	0.750	337	387	19
24700-4098	59	13.000	15.000	0.750	330	381	19	24610-0182	26-L	13.250	15.250	0.750	337	387	19
24742-4098	59	13.000	15.000	0.750	330	381	19	24700-0182	59	13.250	15.250	0.750	337	387	19
24707-4098	59	13.000	15.000	0.750	330	381	19	26088-6264	88-L	13.250	15.250	0.750	337	387	19
21852-4099	64-L	13.000	15.000	0.812	330	381	21	26090-6264	88-L	13.250	15.250	0.750	337	387	19
25001-4099	21-L	13.000	15.000	0.813	330	381	21	25001-4779	21-L	13.250	15.250	0.813	337	387	21
25003-4099	23-L	13.000	15.000	0.813	330	381	21	25003-4779	23-L	13.250	15.250	0.813	337	387	21
21238-4099	64-L	13.000	15.000	0.813	330	381	21	21238-4779	64-L	13.250	15.250	0.813	337	387	21
21773-4099	64-L	13.000	15.000	0.813	330	381	21	21086-4107	53-L	13.250	15.250	1.000	337	387	25
21225-4099	64-L	13.000	15.000	0.813	330	381	21	24700-5740	59	13.250	15.250	1.000	337	387	25
21243-4099	64-L	13.000	15.000	0.813	330	381	21	21086-4109	53-L	13.250	15.375	1.000	337	391	25
21086-3719	53-L	13.000	15.000	1.000	330	381	25	21699-4109	53-L	13.250	15.375	1.000	337	391	25
22627-6607	53R2-L	13.000	15.000	1.375	330	381	35	24700-0183	59	13.250	15.375	1.000	337	391	25
21339-3173	143	13.000	17.062	2.000	330	433	51	21086-4113	53-L	13.250	15.500	1.000	337	394	25
25006-0994	23-L	13.070	14.570	0.750	332	370	19	24700-6477	59	13.312	14.375	0.625	338	365	16
25003-4104	23-L	13.094	15.094	0.750	333	383	19	25003-9331	23-L	13.375	14.375	0.500	340	365	13
25003-9258	23-L	13.125	14.625	0.750	333	371	19	24627-4060	26-L	13.375	14.875	0.653	340	378	17
25003-9949	23-L	13.125	14.875	0.625	333	378	16	25003-7323	23-L	13.375	14.875	0.750	340	378	19
25003-1769	23-L	13.125	15.000	0.750	333	381	19	25003-4006	23-L	13.375	15.000	0.750	340	381	19
25003-7602	23-L	13.125	15.125	0.750	333	384	19	24700-0186	59	13.375	15.000	0.750	340	381	19
25135-5783	23-L	13.125	15.125	0.813	333	384	21	25003-9256	23-L	13.375	15.375	0.813	340	391	21
25003-5783	23-L	13.125	15.125	0.813	333	384	21	25003-4596	23-L	13.383	14.883	0.750	340	378	19
25045-8332	23-L	13.188	14.188	0.500	335	360	13	24700-0188	59	13.386	14.646	0.630	340	372	16
25003-8332	23-L	13.188	14.188	0.500	335	360	13	24700-0189	59	13.386	14.961	0.689	340	380	18
24700-0177	59	13.220	14.407	0.625	336	366	16	24600-3882	26-L	13.386	14.961	0.709	340	380	18
25003-0489	23-L	13.250	14.250	0.500	337	362	13	24700-3882	59	13.386	14.961	0.709	340	380	18
24700-6401	59	13.250	14.500	0.625	337	368	16	24715-5170	59	13.386	14.961	0.787	340	380	20
25003-6263	23-L	13.250	14.750	0.625	337	375	16	25010-2245	23-L	13.386	15.118	0.787	340	384	20
24715-0178	59	13.250	14.750	0.625	337	375	16	25003-5664	23-L	13.386	15.236	0.748	340	387	19
24700-0178	59	13.250	14.750	0.625	337	375	16	25003-8701	23-L	13.386	14.886	0.750	340	378	19
24626-2580	26-L	13.250	14.750	0.688	337	375	17	24715-0189	59	13.386	14.960	0.688	340	380	17
24600-2580	26-L	13.250	14.750	0.688	337	375	17	25003-7896	23-L	13.386	14.961	0.630	340	380	16
21086-4101	53-L	13.250	14.750	0.688	337	375	17	21086-7896	53-L	13.386	14.961	0.630	340	380	16
21247-4101	64-L	13.250	14.750	0.688	337	375	17	25003-0893	23-L	13.386	14.961	0.708	340	380	18
21773-4101	64-L	13.250	14.750	0.688	337	375	17	24626-3882	26-L	13.386	14.961	0.709	340	380	18
21221-4101	64-L	13.250	14.750	0.688	337	375	17	24610-3882	26-L	13.386	14.961	0.709	340	380	18
21238-4101	64-L	13.250	14.750	0.688	337	375	17	24700-5170	59	13.386	14.961	0.788	340	380	20
21852-4101	64-L	13.250	14.750	0.688	337	375	17	25003-2245	23-L	13.386	15.118	0.787	340	384	20
21854-4101	64-L	13.250	14.750	0.688	337	375	17	25006-2245	23-L	13.386	15.118	0.787	340	384	20
21243-4101	64-L	13.250	14.750	0.688	337	375	17	25003-2286	23-L	13.386	15.157	0.802	340	385	20
25001-4102	21-L	13.250	14.750	0.750	337	375	19	25003-5984	23-L	13.469	14.469	0.500	342	368	13
25003-4102	23-L	13.250	14.750	0.750	337	375	19	25003-3114	23-L	13.469	14.680	0.500	342	373	13
25004-4102	23-L	13.250	14.750	0.750	337	375	19	25003-0986	23-L	13.500	14.500	0.500	343	368	13
21086-4102	53-L	13.250	14.750	0.750	337	375	19	25003-2383	23-L	13.500	14.919	0.700	343	379	18
24751-6301	59G1	13.250	14.750	0.750	337	375	19	25003-8620	23-L	13.500	15.000	0.625	343	381	16
21238-7734	64-L	13.250	14.875	0.688	337	378	17	24620-5456	26R1-L	13.500	15.000	0.653	343	381	17
25003-4103	23-L	13.250	14.875	0.750	337	378	19	24600-5456	26-L	13.500	15.000	0.653	343	381	17

All dimensions are in inches. Preferred sizes are indicated with **bold** type face. Sizes listed are for standard nitrile elements, except Models 25 and 62 which have PTFE elements. Other material available on inquiry only.

## Oil Seals by Model Number

Product Code	Model	Inches			MM			Product Code	Model	Inches			MM		
		ID	OD	Width	ID	OD	Width			ID	OD	Width	ID	OD	Width
21247-4121	64-L	13.500	15.000	0.687	343	381	17	24715-0199	59	13.750	15.250	0.625	349	387	16
25003-4121	23-L	13.500	15.000	0.688	343	381	17	24700-0199	59	13.750	15.250	0.625	349	387	16
21852-4121	64-L	13.500	15.000	0.688	343	381	17	24064-4001	61	13.750	15.250	0.625	349	387	16
21243-4121	64-L	13.500	15.000	0.688	343	381	17	21086-4529	53-L	13.750	15.250	0.688	349	387	17
26088-4121	88-L	13.500	15.000	0.688	343	381	17	21238-4529	64-L	13.750	15.250	0.688	349	387	17
25010-4122	23-L	13.500	15.000	0.750	343	381	19	25003-4530	23-L	13.750	15.250	0.750	349	387	19
25003-4122	23-L	13.500	15.000	0.750	343	381	19	25006-4530	23-L	13.750	15.250	0.750	349	387	19
25006-4122	23-L	13.500	15.000	0.750	343	381	19	24612-4530	26-L	13.750	15.250	0.750	349	387	19
24610-2006	26-L	13.500	15.000	0.750	343	381	19	24626-4530	26-L	13.750	15.250	0.750	349	387	19
21238-4124	64-L	13.500	15.250	0.750	343	387	19	24600-4530	26-L	13.750	15.250	0.750	349	387	19
21086-4125	53-L	13.500	15.375	0.750	343	391	19	24610-4530	26-L	13.750	15.250	0.750	349	387	19
26086-2982	88-L	13.500	15.500	0.688	343	394	17	21086-4530	53-L	13.750	15.250	0.750	349	387	19
26088-2982	88-L	13.500	15.500	0.688	343	394	17	21086-4531	53-L	13.750	15.500	0.750	349	394	19
26588-2982	88-L	13.500	15.500	0.688	343	394	17	21091-4531	53-L	13.750	15.500	0.750	349	394	19
25003-4127	23-L	13.500	15.500	0.750	343	394	19	24700-0200	59	13.750	15.500	0.750	349	394	19
24600-4127	26-L	13.500	15.500	0.750	343	394	19	24702-0200	59	13.750	15.500	0.750	349	394	19
24610-4127	26-L	13.500	15.500	0.750	343	394	19	21238-4531	64-L	13.750	15.500	0.750	349	394	19
21086-4127	53-L	13.500	15.500	0.750	343	394	19	25001-4532	21-L	13.750	15.750	0.750	349	400	19
24700-4127	59	13.500	15.500	0.750	343	394	19	25003-4532	23-L	13.750	15.750	0.750	349	400	19
24702-4127	59	13.500	15.500	0.750	343	394	19	21702-4129	62	13.750	15.750	0.812	349	400	21
21247-4128	64-L	13.500	15.500	0.812	343	394	21	25003-4129	23-L	13.750	15.750	0.813	349	400	21
25003-4128	23-L	13.500	15.500	0.813	343	394	21	21247-4129	64-L	13.750	15.750	0.813	349	400	21
25006-4128	23-L	13.500	15.500	0.813	343	394	21	21238-4129	64-L	13.750	15.750	0.813	349	400	21
21937-4128	64-L	13.500	15.500	0.813	343	394	21	21840-4129	64-L	13.750	15.750	0.813	349	400	21
21238-4128	64-L	13.500	15.500	0.813	343	394	21	21243-4129	64-L	13.750	15.750	0.813	349	400	21
21852-4128	64-L	13.500	15.500	0.813	343	394	21	21852-4129	64-L	13.750	15.750	0.813	349	400	21
21243-4128	64-L	13.500	15.500	0.813	343	394	21	21096-3722	53-L	13.750	15.750	1.000	349	400	25
26086-4128	88-L	13.500	15.500	0.813	343	394	21	21086-3722	53-L	13.750	15.750	1.000	349	400	25
26588-4128	88-L	13.500	15.500	0.813	343	394	21	24700-5711	59	13.750	15.750	1.000	349	400	25
21086-3721	53-L	13.500	15.500	1.000	343	394	25	22897-5304	53T2-L	13.750	15.750	1.438	349	400	37
22537-6154	53R1-L	13.500	15.500	1.375	343	394	35	21238-4119	64-L	13.750	16.000	0.813	349	406	21
22627-6154	53R2-L	13.500	15.500	1.375	343	394	35	24700-0203	59	13.750	16.000	0.875	349	406	22
21243-4123	64-L	13.500	15.750	0.813	343	400	21	25006-9316	23-L	13.779	15.279	0.750	350	388	19
21238-4123	64-L	13.500	15.750	0.813	343	400	21	25003-3009	23-L	13.779	15.354	0.709	350	390	18
24700-1255	59	13.500	16.500	1.000	343	419	25	24715-0204	59	13.779	15.354	0.709	350	390	18
21086-4121	53-L	13.504	15.000	0.709	343	381	18	24702-0204	59	13.779	15.354	0.709	350	390	18
21238-4121	64-L	13.504	15.000	0.709	343	381	18	25004-4603	23-L	13.779	15.512	0.787	350	394	20
21086-4122	53-L	13.504	15.000	0.748	343	381	19	25003-0591	23-L	13.780	14.961	0.394	350	380	10
25003-4666	23-L	13.504	15.504	0.813	343	394	21	24700-3212	59	13.780	14.961	0.630	350	380	16
25003-5659	23-L	13.563	15.062	0.750	345	383	19	25003-5477	23-L	13.780	15.276	0.500	350	388	13
25003-5640	23-L	13.580	14.580	0.500	345	370	13	25003-9316	23-L	13.780	15.276	0.748	350	388	19
25003-5683	23-L	13.580	15.030	0.750	345	382	19	25003-8656	23-L	13.780	15.354	0.630	350	390	16
25003-7019	23-L	13.622	15.122	0.750	346	384	19	24700-0204	59	13.780	15.354	0.709	350	390	18
25003-3036	23-L	13.625	14.500	0.375	346	368	10	24610-2638	26-L	13.780	15.512	0.866	350	394	22
25003-5383	23-L	13.625	14.625	0.500	346	371	13	25003-5874	23-L	13.780	15.709	0.787	350	399	20
24700-2018	59	13.625	14.875	0.688	346	378	17	24700-3490	59	13.780	15.748	0.669	350	400	17
25003-5825	23-L	13.625	14.875	0.750	346	378	19	24700-3091	59	13.780	15.748	0.984	350	400	25
25058-5825	25	13.625	14.875	0.750	346	378	19	24700-1902	59	13.780	16.142	0.787	350	410	20
25003-0726	23-L	13.625	15.031	0.750	346	382	19	24700-4755	59	13.780	14.961	0.787	350	380	20
24610-5686	26-L	13.625	16.000	0.984	346	406	25	21334-2899	143	13.780	15.092	0.781	350	383	20
25003-7175	23-L	13.750	14.750	0.500	349	375	13	25003-2109	23-L	13.780	15.512	0.500	350	394	13
25006-7175	23-L	13.750	14.750	0.500	349	375	13	24700-5107	59	13.780	15.512	0.748	350	394	19
21432-8106	142-L	13.750	14.750	0.750	349	375	19	24600-5102	26-L	13.780	15.512	0.787	350	394	20
25003-0453	23-L	13.750	15.000	0.750	349	381	19	26080-4603	87-L	13.780	15.512	0.787	350	394	20
25003-2980	23-L	13.750	15.250	0.500	349	387	13	24700-5102	59	13.780	15.512	0.788	350	394	20
24702-0199	59	13.750	15.250	0.625	349	387	16	24700-5477	59	13.780	16.142	0.984	350	410	25

All dimensions are in inches. Preferred sizes are indicated with **bold** type face.

Sizes listed are for standard nitrile elements, except Models 25 and 62 which have PTFE elements. Other material available on inquiry only.

## Oil Seals by Model Number

Product Code	Model	Inches			MM			Product Code	Model	Inches			MM		
		ID	OD	Width	ID	OD	Width			ID	OD	Width	ID	OD	Width
21238-4108	64-L	13.813	16.000	0.812	351	406	21	24742-0214	59	14.000	15.625	0.625	356	397	16
25003-6515	23-L	13.850	15.500	0.750	352	394	19	25003-4252	23-L	14.000	15.625	0.750	356	397	19
25003-3563	23-L	13.875	14.875	0.500	352	378	13	25003-6324	23-L	14.000	15.750	0.500	356	400	13
25135-1528	23-L	13.875	15.057	0.591	352	382	15	21702-5991	62	14.000	15.750	0.687	356	400	17
25003-7379	23-L	13.875	15.375	0.750	352	391	19	24700-0215	59	14.000	15.750	0.688	356	400	17
25003-0690	23-L	13.875	15.500	0.600	352	394	15	21773-5991	64-L	14.000	15.750	0.688	356	400	17
25003-3549	23-L	13.875	15.875	0.500	352	403	13	21238-5991	64-L	14.000	15.750	0.688	356	400	17
25003-4137	23-L	13.875	15.875	0.813	352	403	21	21852-5991	64-L	14.000	15.750	0.688	356	400	17
21238-4110	64-L	13.875	16.000	0.813	352	406	21	21243-5991	64-L	14.000	15.750	0.688	356	400	17
25003-8999	23-L	13.895	15.750	0.750	353	400	19	25003-4134	23-L	14.000	15.750	0.750	356	400	19
25003-9929	23-L	13.925	15.925	0.812	354	404	21	21086-4134	53-L	14.000	15.750	0.750	356	400	19
25003-9783	23-L	13.937	15.437	0.750	354	392	19	21238-4134	64-L	14.000	15.750	0.750	356	400	19
24600-5484	26-L	13.937	15.437	0.750	354	392	19	25003-3842	23-L	14.000	15.750	0.812	356	400	21
24610-5484	26-L	13.937	15.437	0.750	354	392	19	26081-9927	87-L	14.000	15.750	0.875	356	400	22
21238-4130	64-L	13.938	15.437	0.688	354	392	17	25003-9763	23-L	14.000	16.000	0.625	356	406	16
21243-4130	64-L	13.938	15.437	0.688	354	392	17	25003-6877	23-L	14.000	16.000	0.750	356	406	19
21238-4112	64-L	13.938	16.000	0.687	354	406	17	25004-6877	23-L	14.000	16.000	0.750	356	406	19
24700-0211	59	13.938	16.000	0.875	354	406	22	24627-0217	26-L	14.000	16.000	0.750	356	406	19
25003-4568	23-L	13.969	15.469	0.750	355	393	19	24610-0217	26-L	14.000	16.000	0.750	356	406	19
21339-3175	143	13.976	18.038	2.000	355	458	51	24700-0217	59	14.000	16.000	0.750	356	406	19
24700-5441	59	13.976	15.551	0.787	355	395	20	24702-0217	59	14.000	16.000	0.750	356	406	19
25003-6518	23-L	13.980	15.500	0.750	355	394	19	25001-4135	21-L	14.000	16.000	0.813	356	406	21
25045-6560	23-L	14.000	15.000	0.500	356	381	13	25002-4135	21-L	14.000	16.000	0.813	356	406	21
25003-6560	23-L	14.000	15.000	0.500	356	381	13	25003-4135	23-L	14.000	16.000	0.813	356	406	21
25006-6560	23-L	14.000	15.000	0.500	356	381	13	25006-4135	23-L	14.000	16.000	0.813	356	406	21
21443-6519	142-L	14.000	15.000	0.750	356	381	19	21247-4135	64-L	14.000	16.000	0.813	356	406	21
21432-3099	142-L	14.000	15.125	1.375	356	384	35	21773-4135	64-L	14.000	16.000	0.813	356	406	21
21443-5375	142-L	14.000	15.125	1.375	356	384	35	21238-4135	64-L	14.000	16.000	0.813	356	406	21
25003-8850	23-L	14.000	15.250	0.750	356	387	19	21854-4135	64-L	14.000	16.000	0.813	356	406	21
24610-6838	26-L	14.000	15.375	0.709	356	391	18	21852-4135	64-L	14.000	16.000	0.813	356	406	21
25003-4267	23-L	14.000	15.422	0.520	356	392	13	21243-4135	64-L	14.000	16.000	0.813	356	406	21
25003-6303	23-L	14.000	15.500	0.625	356	394	16	21086-3725	53-L	14.000	16.000	1.000	356	406	25
24715-0212	59	14.000	15.500	0.625	356	394	16	24600-3726	26-L	14.000	16.250	1.000	356	413	25
24700-0212	59	14.000	15.500	0.625	356	394	16	21086-3726	53-L	14.000	16.250	1.000	356	413	25
24747-0212	59	14.000	15.500	0.625	356	394	16	24715-3726	59	14.000	16.250	1.000	356	413	25
24702-0212	59	14.000	15.500	0.625	356	394	16	24700-3726	59	14.000	16.250	1.000	356	413	25
25003-4131	23-L	14.000	15.500	0.688	356	394	17	24702-0218	59	14.000	16.500	0.813	356	419	21
21238-4131	64-L	14.000	15.500	0.688	356	394	17	21238-7535	64-L	14.000	16.500	0.813	356	419	21
21852-4131	64-L	14.000	15.500	0.688	356	394	17	21086-3727	53-L	14.000	16.500	1.000	356	419	25
25001-4132	21-L	14.000	15.500	0.750	356	394	19	24700-0219	59	14.000	16.625	0.625	356	422	16
25011-4132	23-L	14.000	15.500	0.750	356	394	19	25003-9287	23-L	14.013	15.513	0.750	356	394	19
25135-4132	23-L	14.000	15.500	0.750	356	394	19	24600-8815	26-L	14.016	15.000	0.688	356	381	17
25003-4132	23-L	14.000	15.500	0.750	356	394	19	24610-3081	26-L	14.041	15.541	0.625	357	395	16
25144-4132	23-L	14.000	15.500	0.750	356	394	19	25003-6778	23-L	14.063	16.062	0.812	357	408	21
25006-4132	23-L	14.000	15.500	0.750	356	394	19	25003-0480	23-L	14.094	15.500	0.750	358	394	19
25004-4132	23-L	14.000	15.500	0.750	356	394	19	25003-9512	23-L	14.100	15.600	0.750	358	396	19
24627-0621	26-L	14.000	15.500	0.750	356	394	19	25003-4384	23-L	14.125	15.125	0.500	359	384	13
24610-0621	26-L	14.000	15.500	0.750	356	394	19	25003-9687	23-L	14.125	15.625	0.750	359	397	19
24667-0621	26-L	14.000	15.500	0.750	356	394	19	24700-3003	59	14.125	15.625	0.750	359	397	19
21086-4132	53-L	14.000	15.500	0.750	356	394	19	25003-5815	23-L	14.166	15.750	0.625	360	400	16
21702-4132	62	14.000	15.500	0.750	356	394	19	25006-0963	23-L	14.173	15.591	0.630	360	396	16
24620-4129	26R1-L	14.000	15.500	1.000	356	394	25	25010-5846	23-L	14.173	15.673	0.750	360	398	19
25003-4133	23-L	14.000	15.563	0.750	356	395	19	25003-5846	23-L	14.173	15.673	0.750	360	398	19
21086-4133	53-L	14.000	15.563	0.750	356	395	19	24610-6413	26-L	14.173	15.673	0.750	360	398	19
24700-0213	59	14.000	15.563	0.750	356	395	19	25003-7849	23-L	14.173	15.748	0.630	360	400	16
24700-0214	59	14.000	15.625	0.625	356	397	16	24610-1892	26-L	14.173	15.748	0.787	360	400	20

All dimensions are in inches. Preferred sizes are indicated with **bold** type face.  
 Sizes listed are for standard nitrile elements, except Models 25 and 62 which have PTFE elements. Other material available on inquiry only.

## Oil Seals by Model Number

Product Code	Model	Inches			MM			Product Code	Model	Inches			MM		
		ID	OD	Width	ID	OD	Width			ID	OD	Width	ID	OD	Width
24602-1892	26-L	14.173	15.748	0.787	360	400	20	26088-8664	88-L	14.344	16.000	0.688	364	406	17
25010-1202	23-L	14.173	15.905	0.787	360	404	20	24700-0231	59	14.370	15.938	0.709	365	405	18
25003-1202	23-L	14.173	15.905	0.787	360	404	20	25003-3250	23-L	14.370	15.866	0.748	365	403	19
24626-5327	26-L	14.173	15.905	0.787	360	404	20	24700-0232	59	14.375	15.875	0.750	365	403	19
26080-1202	87-L	14.173	15.906	0.787	360	404	20	25003-5481	23-L	14.375	16.000	0.687	365	406	17
25003-3708	23-L	14.173	15.945	0.812	360	405	21	24600-0233	26-L	14.375	16.000	0.688	365	406	17
25010-2446	23-L	14.173	15.945	0.984	360	405	25	24700-0233	59	14.375	16.000	0.688	365	406	17
25003-3899	23-L	14.173	16.142	0.709	360	410	18	25003-5134	23-L	14.375	16.375	0.750	365	416	19
24600-0992	26-L	14.173	15.354	0.709	360	390	18	25003-2700	23-L	14.394	15.394	0.500	366	391	13
24700-0992	59	14.173	15.354	0.709	360	390	18	25003-0785	23-L	14.438	15.938	0.625	367	405	16
21086-7849	53-L	14.173	15.748	0.630	360	400	16	25003-3238	23-L	14.488	16.220	0.787	368	412	20
24626-4394	26-L	14.173	15.748	0.709	360	400	18	26081-2134	87-L	14.488	16.496	0.811	368	419	21
24600-4394	26-L	14.173	15.748	0.709	360	400	18	26080-2134	87-L	14.488	16.496	0.811	368	419	21
24700-4394	59	14.173	15.748	0.709	360	400	18	25003-8741	23-L	14.500	15.500	0.500	368	394	13
25003-9182	23-L	14.173	15.748	0.787	360	400	20	21443-2338	142-L	14.500	15.500	0.750	368	394	19
24641-5327	26-L	14.173	15.906	0.787	360	404	20	21443-5376	142-L	14.500	15.625	1.375	368	397	35
24781-3999	59	14.173	15.945	0.984	360	405	25	25003-4699	23-L	14.500	15.750	0.625	368	400	16
25003-2066	23-L	14.174	15.354	0.709	360	390	18	25003-1018	23-L	14.500	15.750	0.750	368	400	19
24700-1892	59	14.174	15.748	0.788	360	400	20	26088-2676	88-L	14.500	16.000	0.563	368	406	14
24716-1892	59	14.174	15.748	0.788	360	400	20	25010-7149	23-L	14.500	16.000	0.625	368	406	16
24702-1892	59	14.174	15.748	0.788	360	400	20	25003-7149	23-L	14.500	16.000	0.625	368	406	16
25003-0241	23-L	14.177	15.500	0.750	360	394	19	25003-4142	23-L	14.500	16.000	0.688	368	406	17
24700-0223	59	14.188	15.750	0.750	360	400	19	21086-4142	53-L	14.500	16.000	0.688	368	406	17
25003-2734	23-L	14.188	16.188	0.750	360	411	19	24715-4142	59	14.500	16.000	0.688	368	406	17
24700-0225	59	14.188	16.188	0.813	360	411	21	24700-4142	59	14.500	16.000	0.688	368	406	17
21238-9280	64-L	14.188	16.732	0.813	360	425	21	24702-4142	59	14.500	16.000	0.688	368	406	17
25003-4138	23-L	14.190	15.690	0.625	360	399	16	21247-4142	64-L	14.500	16.000	0.688	368	406	17
24610-5503	26-L	14.214	16.214	0.812	361	412	21	21937-4142	64-L	14.500	16.000	0.688	368	406	17
25003-7898	23-L	14.214	16.214	0.813	361	412	21	21238-4142	64-L	14.500	16.000	0.688	368	406	17
21221-4118	64-L	14.250	15.750	0.687	362	400	17	21243-4142	64-L	14.500	16.000	0.688	368	406	17
21937-4118	64-L	14.250	15.750	0.688	362	400	17	21852-4142	64-L	14.500	16.000	0.688	368	406	17
21238-4118	64-L	14.250	15.750	0.688	362	400	17	26080-4142	87-L	14.500	16.000	0.688	368	406	17
21773-4118	64-L	14.250	15.750	0.688	362	400	17	26082-4142	87-L	14.500	16.000	0.688	368	406	17
25001-5062	21-L	14.250	15.750	0.750	362	400	19	25010-4143	23-L	14.500	16.000	0.750	368	406	19
25003-5062	23-L	14.250	15.750	0.750	362	400	19	25003-4143	23-L	14.500	16.000	0.750	368	406	19
24700-0227	59	14.250	15.750	0.750	362	400	19	25138-4143	23-L	14.500	16.000	0.750	368	406	19
25003-4691	23-L	14.250	16.000	0.813	362	406	21	25144-4143	23-L	14.500	16.000	0.750	368	406	19
24700-0228	59	14.250	16.000	0.875	362	406	22	25006-4143	23-L	14.500	16.000	0.750	368	406	19
24600-3891	26-L	14.250	16.250	0.625	362	413	16	22504-2132	64G1-L	14.500	16.000	0.813	368	406	21
24602-3891	26-L	14.250	16.250	0.625	362	413	16	25003-5455	23-L	14.500	16.250	0.625	368	413	16
26082-3891	87-L	14.250	16.250	0.625	362	413	16	21086-4144	53-L	14.500	16.250	0.750	368	413	19
26187-3891	88NS-L	14.250	16.250	0.625	362	413	16	25003-9116	23-L	14.500	16.500	0.625	368	419	16
25003-5117	23-L	14.250	16.250	0.750	362	413	19	25001-3728	21-L	14.500	16.500	0.750	368	419	19
24610-5582	26-L	14.250	16.250	0.750	362	413	19	25003-3728	23-L	14.500	16.500	0.750	368	419	19
24610-0229	26-L	14.250	16.250	0.812	362	413	21	21086-3728	53-L	14.500	16.500	0.750	368	419	19
25001-4140	21-L	14.250	16.250	0.813	362	413	21	24752-0234	59G1	14.500	16.500	0.750	368	419	19
25003-4140	23-L	14.250	16.250	0.813	362	413	21	24700-0234	59	14.500	16.500	0.750	368	419	19
25006-4140	23-L	14.250	16.250	0.813	362	413	21	24702-0234	59	14.500	16.500	0.750	368	419	19
24715-0229	59	14.250	16.250	0.813	362	413	21	21247-4145	64-L	14.500	16.500	0.812	368	419	21
24700-0229	59	14.250	16.250	0.813	362	413	21	25003-4145	23-L	14.500	16.500	0.813	368	419	21
21247-4140	64-L	14.250	16.250	0.813	362	413	21	21238-4145	64-L	14.500	16.500	0.813	368	419	21
21238-4140	64-L	14.250	16.250	0.813	362	413	21	21773-4145	64-L	14.500	16.500	0.813	368	419	21
21852-4140	64-L	14.250	16.250	0.813	362	413	21	21243-4145	64-L	14.500	16.500	0.813	368	419	21
21243-4140	64-L	14.250	16.250	0.813	362	413	21	21852-4145	64-L	14.500	16.500	0.813	368	419	21
21238-3855	64-L	14.250	16.500	0.813	362	419	21	26088-4145	88-L	14.500	16.500	0.813	368	419	21
21339-3189	143	14.250	18.312	2.000	362	465	51								

All dimensions are in inches. Preferred sizes are indicated with **bold** type face.

Sizes listed are for standard nitrile elements, except Models 25 and 62 which have PTFE elements. Other material available on inquiry only.

## Oil Seals by Model Number

Product Code	Model	Inches			MM			Product Code	Model	Inches			MM		
		ID	OD	Width	ID	OD	Width			ID	OD	Width	ID	OD	Width
21086-5987	53-L	14.563	16.000	0.625	370	406	16	25001-8271	21-L	14.875	16.875	0.813	378	429	21
24700-5987	59	14.563	16.000	0.625	370	406	16	25003-8271	23-L	14.875	16.875	0.813	378	429	21
25003-9993	23-L	14.566	16.181	0.629	370	411	16	24610-6285	26-L	14.875	16.875	0.875	378	429	22
24620-8196	26R1-L	14.567	16.142	0.787	370	410	20	21238-2622	64-L	14.875	16.875	0.938	378	429	24
24780-1896	59	14.567	16.142	0.787	370	410	20	21852-2622	64-L	14.875	16.875	0.938	378	429	24
24700-3880	59	14.567	16.299	0.787	370	414	20	21086-4150	53-L	14.875	16.875	1.000	378	429	25
24700-5694	59	14.567	16.339	0.787	370	415	20	22987-6846	53F1-L	14.875	16.875	1.219	378	429	31
25003-5845	23-L	14.567	15.551	0.500	370	395	13	21238-3860	64-L	14.875	17.000	0.813	378	432	21
25003-2026	23-L	14.580	16.200	0.625	370	411	16	24700-0246	59	14.906	17.000	0.875	379	432	22
24700-4555	59	14.625	16.000	0.625	371	406	16	25003-9896	23-L	14.938	16.438	0.750	379	418	19
25003-9732	23-L	14.625	16.125	0.750	371	410	19	25003-5475	23-L	14.950	16.500	0.750	380	419	19
24700-0235	59	14.625	16.125	0.750	371	410	19	25003-5801	23-L	14.960	16.460	0.750	380	418	19
21238-3856	64-L	14.625	16.250	0.688	371	413	17	24700-6547	59	14.960	17.000	0.750	380	432	19
24702-0236	59	14.625	16.250	0.750	371	413	19	25003-0614	23-L	14.961	16.535	0.787	380	420	20
25003-6283	23-L	14.688	16.188	0.625	373	411	16	24702-0247	59	14.961	16.535	0.787	380	420	20
24700-0238	59	14.688	16.188	0.625	373	411	16	24700-0247	59	14.961	16.535	0.787	380	420	20
25003-4756	23-L	14.688	16.688	0.813	373	424	21	25003-4601	23-L	14.961	16.693	0.787	380	424	20
25003-8888	23-L	14.750	16.125	0.688	375	410	17	24620-5466	26R1-L	14.961	17.323	0.984	380	440	25
25003-2067	23-L	14.750	16.125	0.750	375	410	19	25003-2328	23-L	14.961	16.535	0.625	380	420	16
25003-8119	23-L	14.750	16.250	0.625	375	413	16	25045-0614	23-L	14.961	16.535	0.787	380	420	20
25001-9696	21-L	14.750	16.250	0.668	375	413	17	25006-0614	23-L	14.961	16.535	0.787	380	420	20
25001-4147	21-L	14.750	16.250	0.688	375	413	17	24610-0247	26-L	14.961	16.535	0.787	380	420	20
25003-4147	23-L	14.750	16.250	0.688	375	413	17	24782-0247	59	14.961	16.535	0.787	380	420	20
24700-4147	59	14.750	16.250	0.688	375	413	17	24743-6402	59	14.961	16.693	0.562	380	424	14
21247-4147	64-L	14.750	16.250	0.688	375	413	17	24700-6402	59	14.961	16.693	0.562	380	424	14
21238-4147	64-L	14.750	16.250	0.688	375	413	17	24756-5278	59	14.961	16.693	0.661	380	424	17
21852-4147	64-L	14.750	16.250	0.688	375	413	17	24742-5278	59	14.961	16.693	0.661	380	424	17
25003-4148	23-L	14.750	16.250	0.750	375	413	19	24743-5278	59	14.961	16.693	0.661	380	424	17
25006-4148	23-L	14.750	16.250	0.750	375	413	19	24610-4674	26-L	14.961	16.693	0.787	380	424	20
24700-0239	59	14.750	16.260	0.625	375	413	16	24700-4674	59	14.961	16.693	0.787	380	424	20
25003-5990	23-L	14.750	16.500	0.687	375	419	17	24610-3900	26-L	14.961	16.693	0.866	380	424	22
24700-0240	59	14.750	16.500	0.688	375	419	17	24700-5466	59	14.961	17.323	0.984	380	440	25
24702-0240	59	14.750	16.500	0.688	375	419	17	25003-3385	23-L	15.000	16.000	0.375	381	406	10
21247-5990	64-L	14.750	16.500	0.688	375	419	17	25003-5508	23-L	15.000	16.000	0.500	381	406	13
21238-5990	64-L	14.750	16.500	0.688	375	419	17	25003-4970	23-L	15.000	16.125	0.547	381	410	14
21840-5990	64-L	14.750	16.500	0.688	375	419	17	21432-0418	142-L	15.000	16.125	1.375	381	410	35
21243-5990	64-L	14.750	16.500	0.688	375	419	17	25003-1175	23-L	15.000	16.250	0.625	381	413	16
21852-5990	64-L	14.750	16.500	0.688	375	419	17	25003-0662	23-L	15.000	16.250	0.813	381	413	21
25003-4149	23-L	14.750	16.500	0.750	375	419	19	25003-3091	23-L	15.000	16.375	0.531	381	416	13
24751-5995	59G1	14.750	16.500	0.812	375	419	21	26080-3326	87-L	15.000	16.500	0.625	381	419	16
24715-5995	59	14.750	16.500	0.812	375	419	21	24610-0248	26-L	15.000	16.500	0.687	381	419	17
25003-1617	23-L	14.750	16.500	0.813	375	419	21	21840-4151	64-L	15.000	16.500	0.687	381	419	17
26088-8794	88-L	14.750	16.500	0.875	375	419	22	25003-4151	23-L	15.000	16.500	0.688	381	419	17
25003-3149	23-L	14.750	16.625	0.813	375	422	21	21086-4151	53-L	15.000	16.500	0.688	381	419	17
25003-9254	23-L	14.750	16.750	0.750	375	425	19	24715-0248	59	15.000	16.500	0.688	381	419	17
25006-9254	23-L	14.750	16.750	0.750	375	425	19	24700-0248	59	15.000	16.500	0.688	381	419	17
25003-9591	23-L	14.750	16.750	0.813	375	425	21	21247-4151	64-L	15.000	16.500	0.688	381	419	17
25006-9591	23-L	14.750	16.750	0.813	375	425	21	21242-4151	64-L	15.000	16.500	0.688	381	419	17
24702-4423	59	14.764	16.535	0.787	375	420	20	21238-4151	64-L	15.000	16.500	0.688	381	419	17
24700-4423	59	14.764	16.535	0.787	375	420	20	21243-4151	64-L	15.000	16.500	0.688	381	419	17
25003-3262	23-L	14.810	15.685	0.375	376	398	10	21852-4151	64-L	15.000	16.500	0.688	381	419	17
25003-8281	23-L	14.875	16.375	0.750	378	416	19	25018-4152	21-L	15.000	16.500	0.750	381	419	19
25003-4414	23-L	14.875	16.500	0.750	378	419	19	25001-4152	21-L	15.000	16.500	0.750	381	419	19
24700-6127	59	14.875	16.750	0.687	378	425	17	25010-4152	23-L	15.000	16.500	0.750	381	419	19
25003-1454	23-L	14.875	16.875	0.375	378	429	10	25045-4152	23-L	15.000	16.500	0.750	381	419	19
25003-9163	23-L	14.875	16.875	0.500	378	429	13	25003-4152	23-L	15.000	16.500	0.750	381	419	19

All dimensions are in inches. Preferred sizes are indicated with **bold** type face. Sizes listed are for standard nitrile elements, except Models 25 and 62 which have PTFE elements. Other material available on inquiry only.





Oil Seals by Model Number

Product Code	Model	Inches			MM			Product Code	Model	Inches			MM		
		ID	OD	Width	ID	OD	Width			ID	OD	Width	ID	OD	Width
24610-6153	26-L	15.375	16.875	0.750	391	429	19	24700-4396	59	15.748	17.323	0.787	400	440	20
25006-1013	23-L	15.375	17.125	0.813	391	435	21	25006-4629	23-L	15.748	17.480	0.787	400	444	20
24700-0257	59	15.375	17.250	0.750	391	438	19	25004-4629	23-L	15.748	17.480	0.787	400	444	20
25003-4159	23-L	15.375	17.375	0.813	391	441	21	26080-1184	87-L	15.748	17.480	0.787	400	444	20
21238-4159	64-L	15.375	17.375	0.813	391	441	21	24609-1332	26-L	15.748	17.481	0.787	400	444	20
21086-4160	53-L	15.375	17.375	1.000	391	441	25	24700-1332	59	15.748	17.481	0.787	400	444	20
25003-1449	23-L	15.438	16.938	0.750	392	430	19	24716-1332	59	15.748	17.481	0.787	400	444	20
25003-3690	23-L	15.472	17.472	0.750	393	444	19	24700-4429	59	15.748	17.716	0.761	400	450	19
25003-4625	23-L	15.500	16.500	0.500	394	419	13	24707-4429	59	15.748	17.716	0.761	400	450	19
25003-4033	23-L	15.500	16.750	0.562	394	425	14	24743-4429	59	15.748	17.717	.761	400	450	19
21335-2473	143	15.500	16.812	0.781	394	427	20	24702-4010	59	15.748	17.717	0.787	400	450	20
21333-2473	143	15.500	16.812	0.781	394	427	20	25003-2069	23-L	15.748	17.717	0.788	400	450	20
24700-0260	59	15.500	16.875	0.625	394	429	16	25006-2069	23-L	15.748	17.717	0.788	400	450	20
25001-4162	21-L	15.500	17.000	0.750	394	432	19	25003-2275	23-L	15.748	17.717	0.812	400	450	21
25003-4162	23-L	15.500	17.000	0.750	394	432	19	24627-4509	26-L	15.748	17.748	0.625	400	451	16
24600-4162	26-L	15.500	17.000	0.750	394	432	19	24610-4509	26-L	15.748	17.748	0.625	400	451	16
24700-4162	59	15.500	17.000	0.750	394	432	19	24715-4509	59	15.748	17.748	0.625	400	451	16
25003-6562	23-L	15.500	17.250	0.750	394	438	19	25003-8713	23-L	15.748	17.748	0.750	400	451	19
25003-0432	23-L	15.500	17.375	0.813	394	441	21	25003-5666	23-L	15.748	17.244	0.748	400	438	19
25054-7431	23-L	15.500	17.500	0.750	394	445	19	24626-4396	26-L	15.748	17.323	0.787	400	440	20
25003-7431	23-L	15.500	17.500	0.750	394	445	19	24600-4396	26-L	15.748	17.323	0.787	400	440	20
24752-0261	59G1	15.500	17.500	0.750	394	445	19	25003-8702	23-L	15.748	17.480	0.669	400	444	17
24715-0261	59	15.500	17.500	0.750	394	445	19	25003-4629	23-L	15.748	17.480	0.787	400	444	20
24700-0261	59	15.500	17.500	0.750	394	445	19	24600-1332	26-L	15.748	17.480	0.787	400	444	20
24707-0261	59	15.500	17.500	0.750	394	445	19	24641-1332	26-L	15.748	17.480	0.787	400	444	20
24627-5421	26-L	15.500	17.500	0.812	394	445	21	24702-1332	59	15.748	17.480	0.787	400	444	20
24610-5421	26-L	15.500	17.500	0.812	394	445	21	25003-2389	23-L	15.748	17.717	0.709	400	450	18
24700-5421	59	15.500	17.500	0.812	394	445	21	24700-0268	59	15.748	17.717	0.709	400	450	18
24743-5421	59	15.500	17.500	0.812	394	445	21	21238-4169	64-L	15.748	17.717	0.709	400	450	18
21222-4163	64-L	15.500	17.500	0.812	394	445	21	24700-2726	59	15.748	17.717	0.748	400	450	19
25001-4163	21-L	15.500	17.500	0.813	394	445	21	24627-5392	26-L	15.748	17.717	0.866	400	450	22
25003-4163	23-L	15.500	17.500	0.813	394	445	21	25006-4620	23-L	15.749	17.323	0.787	400	440	20
25006-4163	23-L	15.500	17.500	0.813	394	445	21	25003-6873	23-L	15.750	16.750	0.500	400	425	13
21247-4163	64-L	15.500	17.500	0.813	394	445	21	21432-6430	142-L	15.750	16.875	1.250	400	429	32
21773-4163	64-L	15.500	17.500	0.813	394	445	21	25003-7858	23-L	15.750	17.250	0.563	400	438	14
21226-4163	64-L	15.500	17.500	0.813	394	445	21	26081-4170	87-L	15.750	17.250	0.687	400	438	17
21238-4163	64-L	15.500	17.500	0.813	394	445	21	26080-4170	87-L	15.750	17.250	.687	400	438	17
21852-4163	64-L	15.500	17.500	0.813	394	445	21	24700-0270	59	15.750	17.250	0.688	400	438	17
26188-4163	88NS-L	15.500	17.500	0.813	394	445	21	24702-0270	59	15.750	17.250	0.688	400	438	17
26088-4163	88-L	15.500	17.500	0.813	394	445	21	21247-4170	64-L	15.750	17.250	0.688	400	438	17
24627-9452	26-L	15.500	17.500	0.875	394	445	22	21773-4170	64-L	15.750	17.250	0.688	400	438	17
24612-9452	26-L	15.500	17.500	0.875	394	445	22	21222-4170	64-L	15.750	17.250	0.688	400	438	17
25003-2206	23-L	15.512	16.536	0.500	394	420	13	21238-4170	64-L	15.750	17.250	0.688	400	438	17
24600-5500	26-L	15.551	16.929	0.709	395	430	18	21840-4170	64-L	15.750	17.250	0.688	400	438	17
24620-0979	26R1-L	15.551	17.283	0.740	395	439	19	21243-4170	64-L	15.750	17.250	0.688	400	438	17
24619-0979	26R1-L	15.551	17.283	0.740	395	439	19	21852-4170	64-L	15.750	17.250	0.688	400	438	17
24600-3867	26-L	15.551	17.283	0.866	395	439	22	26188-4170	88NS-L	15.750	17.250	0.688	400	438	17
25045-7592	23-L	15.565	16.565	0.500	395	421	13	26086-4170	88-L	15.750	17.250	0.688	400	438	17
25003-7592	23-L	15.565	16.565	0.500	395	421	13	26088-4170	88-L	15.750	17.250	0.688	400	438	17
25003-2619	23-L	15.625	17.625	0.812	397	448	21	25003-9595	23-L	15.750	17.250	0.750	400	438	19
24700-0266	59	15.625	17.625	0.875	397	448	22	24627-5475	26-L	15.750	17.250	0.750	400	438	19
25003-6455	23-L	15.630	17.126	0.748	397	435	19	21852-9271	64-L	15.750	17.312	0.688	400	440	17
24700-0265	59	15.630	17.126	0.748	397	435	19	21238-9271	64-L	15.750	17.313	0.688	400	440	17
21333-3232	143	15.748	17.060	0.781	400	433	20	21238-4171	64-L	15.750	17.500	0.688	400	445	17
24700-5064	59	15.748	17.323	0.630	400	440	16	25003-7442	23-L	15.750	17.500	0.750	400	445	19
24610-4396	26-L	15.748	17.323	0.787	400	440	20	25003-5865	23-L	15.750	17.500	0.812	400	445	21

All dimensions are in inches. Preferred sizes are indicated with **bold** type face. Sizes listed are for standard nitrile elements, except Models 25 and 62 which have PTFE elements. Other material available on inquiry only.

## Oil Seals by Model Number

Product Code	Model	Inches			MM			Product Code	Model	Inches			MM		
		ID	OD	Width	ID	OD	Width			ID	OD	Width	ID	OD	Width
21238-6874	64-L	15.750	17.750	0.688	400	451	17	24602-4180	26-L	16.000	18.000	0.813	406	457	21
21852-6874	64-L	15.750	17.750	0.688	400	451	17	24702-4180	59	16.000	18.000	0.813	406	457	21
25003-6769	23-L	15.750	17.750	0.813	400	451	21	24717-4180	59	16.000	18.000	0.813	406	457	21
21238-4172	64-L	15.750	18.000	0.813	400	457	21	24742-4180	59	16.000	18.000	0.813	406	457	21
25003-0800	23-L	15.784	17.000	0.500	401	432	13	24743-4180	59	16.000	18.000	0.813	406	457	21
25003-6353	23-L	15.785	17.785	0.813	401	452	21	24707-4180	59	16.000	18.000	0.813	406	457	21
25003-8847	23-L	15.812	17.437	0.812	402	443	21	24700-4180	59	16.000	18.000	0.813	406	457	21
24700-6300	59	15.821	17.500	0.688	402	445	17	24748-4180	59	16.000	18.000	0.813	406	457	21
24627-6473	26-L	15.874	18.000	0.984	403	457	25	21247-4180	64-L	16.000	18.000	0.813	406	457	21
25003-4664	23-L	15.875	17.375	0.750	403	441	19	21937-4180	64-L	16.000	18.000	0.813	406	457	21
25006-4664	23-L	15.875	17.375	0.750	403	441	19	21773-4180	64-L	16.000	18.000	0.813	406	457	21
24700-2493	59	15.875	17.500	0.750	403	445	19	21221-4180	64-L	16.000	18.000	0.813	406	457	21
25001-4795	21-L	15.875	17.750	0.875	403	451	22	21238-4180	64-L	16.000	18.000	0.813	406	457	21
24700-0275	59	15.875	17.875	0.750	403	454	19	21852-4180	64-L	16.000	18.000	0.813	406	457	21
25003-4176	23-L	15.875	17.875	0.813	403	454	21	24626-5077	26-L	16.000	18.000	0.875	406	457	22
21238-4176	64-L	15.875	17.875	0.813	403	454	21	24600-5077	26-L	16.000	18.000	0.875	406	457	22
25003-1439	23-L	15.938	17.437	0.750	405	443	19	24610-5077	26-L	16.000	18.000	0.875	406	457	22
25003-7425	23-L	15.938	17.938	0.750	405	456	19	24627-5077	26-L	16.000	18.000	0.875	406	457	22
24700-2022	59	15.938	18.000	0.750	405	457	19	24612-5077	26-L	16.000	18.000	0.875	406	457	22
25003-9077	23-L	16.000	17.000	0.500	406	432	13	21247-5077	64-L	16.000	18.000	0.875	406	457	22
25006-9077	23-L	16.000	17.000	0.500	406	432	13	21238-5077	64-L	16.000	18.000	0.875	406	457	22
21443-7536	142-L	16.000	17.000	0.750	406	432	19	26095-5077	87-L	16.000	18.000	0.875	406	457	22
21332-2787	143	16.000	17.312	0.781	406	440	20	26080-5077	87-L	16.000	18.000	0.875	406	457	22
25003-7601	23-L	16.000	17.406	0.609	406	442	15	26082-5077	87-L	16.000	18.000	0.875	406	457	22
24610-6190	26-L	16.000	17.500	0.680	406	445	17	26097-5077	87-L	16.000	18.000	0.875	406	457	22
26081-4177	87-L	16.000	17.500	0.687	406	445	17	24610-2800	26-L	16.000	18.000	1.000	406	457	25
26080-4177	87-L	16.000	17.500	0.687	406	445	17	21086-3736	53-L	16.000	18.000	1.000	406	457	25
21086-4177	53-L	16.000	17.500	0.688	406	445	17	21852-2317	64-L	16.000	18.125	0.875	406	460	22
21086-4178	53-L	16.000	17.500	0.688	406	445	17	21238-5995	64-L	16.000	18.500	0.813	406	470	21
24700-0277	59	16.000	17.500	0.688	406	445	17	24627-6405	26-L	16.000	19.000	0.750	406	483	19
21238-4177	64-L	16.000	17.500	0.688	406	445	17	25003-5599	23-L	16.062	17.062	0.500	408	433	13
21852-4177	64-L	16.000	17.500	0.688	406	445	17	25003-3551	23-L	16.068	17.568	0.750	408	446	19
25001-4178	21-L	16.000	17.500	0.750	406	445	19	25003-0479	23-L	16.094	17.500	0.750	409	445	19
25010-4178	23-L	16.000	17.500	0.750	406	445	19	25003-2808	23-L	16.110	18.110	0.787	409	460	20
25003-4178	23-L	16.000	17.500	0.750	406	445	19	25003-5867	23-L	16.125	17.125	0.500	410	435	13
25006-4178	23-L	16.000	17.500	0.750	406	445	19	25003-3766	23-L	16.125	17.625	0.750	410	448	19
24600-4178	26-L	16.000	17.500	0.750	406	445	19	25135-1532	23-L	16.125	17.699	0.787	410	450	20
21238-4173	64-L	16.000	17.625	0.688	406	448	17	25135-1534	23-L	16.125	18.093	0.787	410	460	20
25003-6821	23-L	16.000	17.750	0.750	406	451	19	25003-6878	23-L	16.125	18.125	0.750	410	460	19
25003-1032	23-L	16.000	17.875	0.750	406	454	19	25006-6878	23-L	16.125	18.125	0.750	410	460	19
25005-6693	24-L	16.000	18.000	0.500	406	457	13	25003-5819	23-L	16.125	18.125	0.812	410	460	21
25010-5116	23-L	16.000	18.000	0.750	406	457	19	25003-5803	23-L	16.141	18.141	0.812	410	461	21
25003-5116	23-L	16.000	18.000	0.750	406	457	19	24700-4512	59	16.142	17.717	0.787	410	450	20
24608-0279	26R1-L	16.000	18.000	0.750	406	457	19	24600-4015	26-L	16.142	18.110	0.866	410	460	22
24700-0279	59	16.000	18.000	0.750	406	457	19	25003-2491	23-L	16.187	17.437	0.750	411	443	19
26086-5116	88-L	16.000	18.000	0.750	406	457	19	25003-9484	23-L	16.188	18.188	0.813	411	462	21
26088-5116	88-L	16.000	18.000	0.750	406	457	19	25003-9286	23-L	16.225	17.725	0.750	412	450	19
26090-5116	88-L	16.000	18.000	0.750	406	457	19	25003-5039	23-L	16.250	17.250	0.500	413	438	13
25010-4180	23-L	16.000	18.000	0.812	406	457	21	21432-8556	142-L	16.250	17.250	0.750	413	438	19
24600-4180	26-L	16.000	18.000	0.812	406	457	21	24700-0282	59	16.250	17.750	0.625	413	451	16
24736-4180	59	16.000	18.000	0.812	406	457	21	24600-5120	26-L	16.250	17.750	0.680	413	451	17
21222-4180	64-L	16.000	18.000	0.812	406	457	21	25003-4181	23-L	16.250	17.750	0.688	413	451	17
25001-4180	21-L	16.000	18.000	0.813	406	457	21	25006-4181	23-L	16.250	17.750	0.688	413	451	17
25003-4180	23-L	16.000	18.000	0.813	406	457	21	21086-4181	53-L	16.250	17.750	0.688	413	451	17
25006-4180	23-L	16.000	18.000	0.813	406	457	21	24700-1020	59	16.250	17.750	0.688	413	451	17
24610-4180	26-L	16.000	18.000	0.813	406	457	21	21238-4181	64-L	16.250	17.750	0.688	413	451	17

All dimensions are in inches. Preferred sizes are indicated with **bold** type face.

Sizes listed are for standard nitrile elements, except Models 25 and 62 which have PTFE elements. Other material available on inquiry only.

## Oil Seals by Model Number

Product Code	Model	Inches			MM			Product Code	Model	Inches			MM		
		ID	OD	Width	ID	OD	Width			ID	OD	Width	ID	OD	Width
21852-4181	64-L	16.250	17.750	0.688	413	451	17	25003-4186	23-L	16.500	18.500	0.813	419	470	21
26088-4181	88-L	16.250	17.750	0.688	413	451	17	25006-4186	23-L	16.500	18.500	0.813	419	470	21
26588-4181	88-L	16.250	17.750	0.688	413	451	17	24702-2565	59	16.500	18.500	0.813	419	470	21
25003-4182	23-L	16.250	17.750	0.750	413	451	19	24700-2565	59	16.500	18.500	0.813	419	470	21
21086-4182	53-L	16.250	17.750	0.750	413	451	19	21247-4186	64-L	16.500	18.500	0.813	419	470	21
22627-4650	53R2-L	16.250	17.750	1.281	413	451	33	21255-4186	64-L	16.500	18.500	0.813	419	470	21
22897-4650	53T2-L	16.250	17.750	1.281	413	451	33	21937-4186	64-L	16.500	18.500	0.813	419	470	21
24702-0283	59	16.250	18.000	0.625	413	457	16	21773-4186	64-L	16.500	18.500	0.813	419	470	21
21238-8217	64-L	16.250	18.000	0.688	413	457	17	21238-4186	64-L	16.500	18.500	0.813	419	470	21
21243-8217	64-L	16.250	18.000	0.688	413	457	17	21840-4186	64-L	16.500	18.500	0.813	419	470	21
25003-4184	23-L	16.250	18.000	0.750	413	457	19	21243-4186	64-L	16.500	18.500	0.813	419	470	21
21086-4184	53-L	16.250	18.000	0.750	413	457	19	21852-4186	64-L	16.500	18.500	0.813	419	470	21
25003-9285	23-L	16.250	18.000	0.813	413	457	21	26088-4186	88-L	16.500	18.500	0.813	419	470	21
25006-9285	23-L	16.250	18.000	0.813	413	457	21	25001-5038	21-L	16.500	18.500	0.875	419	470	22
21086-3737	53-L	16.250	18.000	1.000	413	457	25	24610-6194	26-L	16.500	18.500	0.875	419	470	22
25003-6657	23-L	16.250	18.250	0.750	413	464	19	21086-3738	53-L	16.500	18.500	1.000	419	470	25
26081-6657	87-L	16.250	18.250	0.750	413	464	19	21238-4183	64-L	16.500	19.000	0.813	419	483	21
25001-6397	21-L	16.250	18.250	0.813	413	464	21	21243-4183	64-L	16.500	19.000	0.813	419	483	21
25003-6397	23-L	16.250	18.250	0.813	413	464	21	25003-2640	23-L	16.530	17.854	0.500	420	453	13
25144-6397	23-L	16.250	18.250	0.813	413	464	21	25003-5725	23-L	16.531	18.031	0.750	420	458	19
24700-0284	59	16.250	18.250	1.000	413	464	25	25010-7127	23-L	16.535	18.035	0.750	420	458	19
24700-3042	59	16.250	18.500	0.813	413	470	21	25003-7127	23-L	16.535	18.035	0.750	420	458	19
25003-1280	23-L	16.299	18.268	0.811	414	464	21	24765-5130	59	16.535	18.110	0.625	420	460	16
25006-0968	23-L	16.310	17.750	0.688	414	451	17	24702-0295	59	16.535	18.110	0.787	420	460	20
24700-4002	59	16.339	18.307	0.787	415	465	20	24715-0295	59	16.535	18.110	0.787	420	460	20
24780-4002	59	16.339	18.307	0.787	415	465	20	21773-8792	64-L	16.535	18.504	0.688	420	470	17
24610-7279	26-L	16.340	18.309	0.866	415	465	22	25003-3015	23-L	16.535	18.504	0.812	420	470	21
25003-6984	23-L	16.375	17.375	0.500	416	441	13	25010-2625	23-L	16.535	17.913	0.787	420	455	20
25003-9757	23-L	16.375	18.375	0.813	416	467	21	25003-2625	23-L	16.535	17.913	0.787	420	455	20
24715-0287	59	16.375	18.375	1.000	416	467	25	25003-8504	23-L	16.535	18.110	0.787	420	460	20
24700-0287	59	16.375	18.375	1.000	416	467	25	24700-0295	59	16.535	18.110	0.787	420	460	20
25003-5178	23-L	16.378	17.874	0.748	416	454	19	25003-4521	23-L	16.535	18.504	0.748	420	470	19
25003-5747	23-L	16.500	17.500	0.500	419	445	13	25003-8705	23-L	16.535	18.504	0.748	420	470	19
25003-3868	23-L	16.500	17.750	0.750	419	451	19	24600-1331	26-L	16.535	18.504	0.866	420	470	22
24600-3868	26-L	16.500	17.750	0.750	419	451	19	24700-1331	59	16.535	18.504	0.866	420	470	22
25003-2781	23-L	16.500	17.875	0.750	419	454	19	21238-1929	64-L	16.535	18.504	0.866	420	470	22
25003-3968	23-L	16.500	18.000	0.625	419	457	16	25003-5827	23-L	16.625	17.625	0.500	422	448	13
21247-9863	64-L	16.500	18.000	0.688	419	457	17	25003-6601	23-L	16.625	18.625	0.813	422	473	21
21242-9863	64-L	16.500	18.000	0.688	419	457	17	21443-0792	142-L	16.688	17.688	0.750	424	449	19
21238-9863	64-L	16.500	18.000	0.688	419	457	17	24600-3635	26-L	16.688	18.031	0.750	424	458	19
21852-9863	64-L	16.500	18.000	0.688	419	457	17	25003-9529	23-L	16.732	18.701	0.787	425	475	20
25003-4185	23-L	16.500	18.000	0.750	419	457	19	21443-0611	142-L	16.750	17.750	0.750	425	451	19
21087-4185	53-L	16.500	18.000	0.750	419	457	19	21432-2448	142-L	16.750	17.875	1.250	425	454	32
21597-4185	53-L	16.500	18.000	0.750	419	457	19	21432-7886	142-L	16.750	17.875	1.312	425	454	33
21086-4185	53-L	16.500	18.000	0.750	419	457	19	25003-3223	23-L	16.750	18.000	0.750	425	457	19
24702-0289	59	16.500	18.000	0.750	419	457	19	24751-5994	59G1	16.750	18.000	0.750	425	457	19
24715-0289	59	16.500	18.000	0.750	419	457	19	24715-5994	59	16.750	18.000	0.750	425	457	19
24703-0289	59	16.500	18.000	0.750	419	457	19	24700-5994	59	16.750	18.000	0.750	425	457	19
24700-0289	59	16.500	18.000	0.750	419	457	19	21238-3744	64-L	16.750	18.250	0.687	425	464	17
24700-0290	59	16.500	18.250	0.750	419	464	19	24700-0296	59	16.750	18.250	0.688	425	464	17
24610-5100	26-L	16.500	18.500	0.625	419	470	16	25003-8295	23-L	16.750	18.250	0.750	425	464	19
25003-6697	23-L	16.500	18.500	0.750	419	470	19	24700-4534	59	16.750	18.500	0.688	425	470	17
21086-6697	53-L	16.500	18.500	0.750	419	470	19	25003-6398	23-L	16.750	18.750	0.750	425	476	19
24700-0291	59	16.500	18.500	0.750	419	470	19	24608-5276	26R1-L	16.750	18.750	0.750	425	476	19
24707-0291	59	16.500	18.500	0.750	419	470	19	25003-9752	23-L	16.750	18.750	0.813	425	476	21
24627-2565	26-L	16.500	18.500	0.812	419	470	21	25021-3244	23-L	16.875	18.375	0.750	429	467	19

All dimensions are in inches. Preferred sizes are indicated with **bold** type face. Sizes listed are for standard nitrile elements, except Models 25 and 62 which have PTFE elements. Other material available on inquiry only.

## Oil Seals by Model Number

Product Code	Model	Inches			MM			Product Code	Model	Inches			MM		
		ID	OD	Width	ID	OD	Width			ID	OD	Width	ID	OD	Width
25045-3244	23-L	16.875	18.375	0.750	429	467	19	21852-4190	64-L	17.000	19.000	0.813	432	483	21
25003-9303	23-L	16.875	18.875	0.813	429	479	21	21243-4190	64-L	17.000	19.000	0.813	432	483	21
25003-6933	23-L	16.929	17.929	0.500	430	455	13	25001-4712	21-L	17.000	19.000	0.875	432	483	22
25003-5850	23-L	16.929	18.429	0.750	430	468	19	24610-9460	26-L	17.000	19.000	0.875	432	483	22
25006-5850	23-L	16.929	18.429	0.750	430	468	19	24685-0782	26HR-L	17.000	19.000	1.000	432	483	25
25003-5029	23-L	16.929	18.897	0.787	430	480	20	24700-0782	59	17.000	19.000	1.000	432	483	25
25003-3030	23-L	16.929	18.898	0.812	430	480	21	24717-3571	59	17.000	19.000	1.250	432	483	32
24736-4252	59	16.929	18.504	0.787	430	470	20	21238-4191	64-L	17.000	19.250	0.813	432	489	21
24641-3740	26-L	16.929	18.898	0.866	430	480	22	24700-0302	59	17.000	19.250	1.000	432	489	25
24715-3740	59	16.929	18.898	0.866	430	480	22	21238-3750	64-L	17.000	19.500	0.812	432	495	21
24700-3740	59	16.929	18.898	0.866	430	480	22	24700-0304	59	17.000	19.500	0.875	432	495	22
24716-3740	59	16.929	18.898	0.866	430	480	22	24610-6263	26-L	17.087	19.094	0.748	434	485	19
24736-4253	59	16.929	18.898	0.984	430	480	25	24627-6263	26-L	17.087	19.094	0.748	434	485	19
25003-1126	23-L	17.000	17.906	0.500	432	455	13	25003-4059	23-L	17.094	19.094	0.787	434	485	20
25003-1976	23-L	17.000	18.000	0.500	432	457	13	25003-9273	23-L	17.125	18.125	0.500	435	460	13
25001-4971	21-L	17.000	18.125	0.547	432	460	14	25003-6626	23-L	17.125	18.625	0.750	435	473	19
25003-4971	23-L	17.000	18.125	0.547	432	460	14	25003-5983	23-L	17.125	19.125	0.813	435	486	21
25003-9114	23-L	17.000	18.125	0.563	432	460	14	26081-1387	87-L	17.126	19.094	0.787	435	485	20
25003-3247	23-L	17.000	18.250	0.500	432	464	13	26099-1387	87-L	17.126	19.094	0.787	435	485	20
25003-8780	23-L	17.000	18.250	0.625	432	464	16	26188-1387	88NS-L	17.126	19.094	0.787	435	485	20
24600-3793	26-L	17.000	18.250	0.625	432	464	16	26088-1387	88-L	17.126	19.094	0.787	435	485	20
24700-3793	59	17.000	18.250	0.625	432	464	16	26080-1387	87-L	17.126	19.094	0.787	435	485	20
25003-1923	23-L	17.000	18.250	0.750	432	464	19	26086-1387	88-L	17.126	19.094	0.787	435	485	20
25003-2683	23-L	17.000	18.500	0.625	432	470	16	25003-1125	23-L	17.250	18.500	0.625	438	470	16
24700-0300	59	17.000	18.500	0.625	432	470	16	25135-4663	23-L	17.250	18.750	0.625	438	476	16
25003-4188	23-L	17.000	18.500	0.687	432	470	17	25003-4663	23-L	17.250	18.750	0.625	438	476	16
24700-4188	59	17.000	18.500	0.688	432	470	17	24765-5121	59	17.250	18.750	0.625	438	476	16
21247-4188	64-L	17.000	18.500	0.688	432	470	17	25003-6967	23-L	17.250	18.750	0.750	438	476	19
21773-4188	64-L	17.000	18.500	0.688	432	470	17	25144-6967	23-L	17.250	18.750	0.750	438	476	19
21221-4188	64-L	17.000	18.500	0.688	432	470	17	24700-0305	59	17.250	18.750	0.750	438	476	19
21226-4188	64-L	17.000	18.500	0.688	432	470	17	21247-6967	64-L	17.250	18.750	0.750	438	476	19
21238-4188	64-L	17.000	18.500	0.688	432	470	17	21238-6967	64-L	17.250	18.750	0.750	438	476	19
21852-4188	64-L	17.000	18.500	0.688	432	470	17	21852-6967	64-L	17.250	18.750	0.750	438	476	19
21243-4188	64-L	17.000	18.500	0.688	432	470	17	25003-8191	23-L	17.250	19.250	0.813	438	489	21
26188-4188	88NS-L	17.000	18.500	0.688	432	470	17	24600-3055	26-L	17.250	19.250	0.875	438	489	22
26088-4188	88-L	17.000	18.500	0.688	432	470	17	21086-4192	53-L	17.250	19.250	0.938	438	489	24
25003-1459	23-L	17.000	18.500	0.720	432	470	18	24700-0306	59	17.250	19.250	0.938	438	489	24
25001-4189	21-L	17.000	18.500	0.750	432	470	19	25003-4374	23-L	17.313	18.313	0.500	440	465	13
25006-4189	23-L	17.000	18.500	0.750	432	470	19	25003-6812	23-L	17.322	18.822	0.750	440	478	19
25138-4189	23-L	17.000	18.500	0.750	432	470	19	24700-4393	59	17.323	18.898	0.787	440	480	20
25003-4189	23-L	17.000	18.500	0.750	432	470	19	25003-4393	23-L	17.323	18.898	0.787	440	480	20
24700-3741	59	17.000	18.750	0.750	432	476	19	24600-4393	26-L	17.323	18.898	0.787	440	480	20
24600-4977	26-L	17.000	19.000	0.625	432	483	16	24610-4393	26-L	17.323	18.898	0.787	440	480	20
25003-5168	23-L	17.000	19.000	0.750	432	483	19	24702-4393	59	17.323	18.898	0.787	440	480	20
25006-5168	23-L	17.000	19.000	0.750	432	483	19	24700-4673	59	17.323	19.291	0.866	440	490	22
25004-5168	23-L	17.000	19.000	0.750	432	483	19	25003-0620	23-L	17.323	19.323	0.750	440	491	19
24702-0301	59	17.000	19.000	0.750	432	483	19	25003-9315	23-L	17.332	18.832	0.750	440	478	19
24700-0301	59	17.000	19.000	0.750	432	483	19	25003-4351	23-L	17.360	19.360	0.813	441	492	21
24707-0301	59	17.000	19.000	0.750	432	483	19	25003-9338	23-L	17.375	18.875	0.750	441	479	19
26080-5168	87-L	17.000	19.000	0.750	432	483	19	25003-2499	23-L	17.400	19.400	0.812	442	493	21
25003-4190	23-L	17.000	19.000	0.813	432	483	21	25003-9261	23-L	17.500	18.500	0.500	445	470	13
25006-4190	23-L	17.000	19.000	0.813	432	483	21	25003-2021	23-L	17.500	18.750	0.500	445	476	13
25004-4190	23-L	17.000	19.000	0.813	432	483	21	25010-4403	23-L	17.500	19.000	0.625	445	483	16
24627-1867	26-L	17.000	19.000	0.813	432	483	21	25003-4403	23-L	17.500	19.000	0.625	445	483	16
24700-1867	59	17.000	19.000	0.813	432	483	21	24700-0307	59	17.500	19.000	0.625	445	483	16
21238-4190	64-L	17.000	19.000	0.813	432	483	21	21086-4194	53-L	17.500	19.000	0.688	445	483	17

All dimensions are in inches. Preferred sizes are indicated with **bold** type face.

Sizes listed are for standard nitrile elements, except Models 25 and 62 which have PTFE elements. Other material available on inquiry only.

## Oil Seals by Model Number

Product Code	Model	Inches			MM			Product Code	Model	Inches			MM		
		ID	OD	Width	ID	OD	Width			ID	OD	Width	ID	OD	Width
24700-0823	59	17.500	19.000	0.688	445	483	17	25003-5594	23-L	17.719	19.219	0.750	450	488	19
21247-4194	64-L	17.500	19.000	0.688	445	483	17	25003-9581	23-L	17.750	18.750	0.500	451	476	13
21937-4194	64-L	17.500	19.000	0.688	445	483	17	25003-4523	23-L	17.750	19.000	0.750	451	483	19
21238-4194	64-L	17.500	19.000	0.688	445	483	17	25003-6615	23-L	17.750	19.250	0.750	451	489	19
21840-4194	64-L	17.500	19.000	0.688	445	483	17	25003-0477	23-L	17.750	19.373	0.750	451	492	19
21243-4194	64-L	17.500	19.000	0.688	445	483	17	24700-0316	59	17.750	19.750	0.750	451	502	19
21852-4194	64-L	17.500	19.000	0.688	445	483	17	25010-4200	23-L	17.750	19.750	0.813	451	502	21
25003-4195	23-L	17.500	19.000	0.750	445	483	19	25003-4200	23-L	17.750	19.750	0.813	451	502	21
24612-9459	26-L	17.500	19.000	0.750	445	483	19	21238-4200	64-L	17.750	19.750	0.813	451	502	21
21086-4195	53-L	17.500	19.000	0.750	445	483	19	21086-4201	53-L	17.750	19.750	1.000	451	502	25
25003-8476	23-L	17.500	19.250	0.625	445	489	16	24715-1164	59	17.750	19.750	1.000	451	502	25
24700-5054	59	17.500	19.250	0.688	445	489	17	21238-9084	64-L	17.750	20.078	0.875	451	510	22
24716-5054	59	17.500	19.250	0.688	445	489	17	21086-4202	53-L	17.750	20.089	1.000	451	510	25
21238-5054	64-L	17.500	19.250	0.688	445	489	17	21340-3403	143	17.750	21.812	2.000	451	554	51
21852-5054	64-L	17.500	19.250	0.688	445	489	17	25003-4667	23-L	17.795	19.795	0.813	452	503	21
25003-4196	23-L	17.500	19.250	0.750	445	489	19	24700-0318	59	17.818	19.750	0.750	453	502	19
21086-4196	53-L	17.500	19.250	0.750	445	489	19	24700-0319	59	17.818	20.500	1.000	453	521	25
25003-4198	23-L	17.500	19.500	0.688	445	495	17	24700-4600	59	17.874	19.874	0.844	454	505	21
21477-4198	53-L	17.500	19.500	0.688	445	495	17	25003-4815	23-L	17.875	18.875	0.500	454	479	13
24700-0309	59	17.500	19.500	0.688	445	495	17	24700-0321	59	17.875	19.875	0.750	454	505	19
24707-0309	59	17.500	19.500	0.688	445	495	17	25003-4204	23-L	17.875	19.875	0.813	454	505	21
21450-4198	64-L	17.500	19.500	0.688	445	495	17	21238-4204	64-L	17.875	19.875	0.813	454	505	21
21238-4198	64-L	17.500	19.500	0.688	445	495	17	25003-5613	23-L	17.900	19.400	0.750	455	493	19
21852-4198	64-L	17.500	19.500	0.688	445	495	17	25003-0716	23-L	17.938	19.313	0.813	456	491	21
25003-7625	23-L	17.500	19.500	0.750	445	495	19	25003-7487	23-L	18.000	19.000	0.500	457	483	13
24663-3230	26HR-L	17.500	19.500	0.750	445	495	19	21443-3539	142-L	18.000	19.000	0.750	457	483	19
25003-9601	23-L	17.500	19.500	0.813	445	495	21	21432-5147	142-L	18.000	19.125	1.250	457	486	32
21238-4197	64-L	17.500	19.750	0.812	445	502	21	21334-3561	143	18.000	19.312	0.781	457	491	20
21432-1028	142-L	17.559	18.683	1.375	446	475	35	25003-2193	23-L	18.000	19.438	0.500	457	494	13
26088-4704	88-L	17.559	19.134	0.630	446	486	16	25003-4206	23-L	18.000	19.500	0.688	457	495	17
25003-5534	23-L	17.563	19.062	0.750	446	484	19	21086-4206	53-L	18.000	19.500	0.688	457	495	17
25003-5172	23-L	17.625	18.500	0.375	448	470	10	24700-0322	59	18.000	19.500	0.688	457	495	17
25003-7589	23-L	17.625	18.525	0.500	448	471	13	21225-4206	64-L	18.000	19.500	0.688	457	495	17
25003-3412	23-L	17.625	19.125	0.750	448	486	19	21247-4206	64-L	18.000	19.500	0.688	457	495	17
24610-0312	26-L	17.625	19.125	0.750	448	486	19	21773-4206	64-L	18.000	19.500	0.688	457	495	17
24700-0312	59	17.625	19.125	0.750	448	486	19	21238-4206	64-L	18.000	19.500	0.688	457	495	17
21247-4199	64-L	17.625	19.250	0.688	448	489	17	21243-4206	64-L	18.000	19.500	0.688	457	495	17
21238-4199	64-L	17.625	19.250	0.688	448	489	17	21852-4206	64-L	18.000	19.500	0.688	457	495	17
21852-4199	64-L	17.625	19.250	0.688	448	489	17	25010-3741	23-L	18.000	19.500	0.750	457	495	19
25003-1158	23-L	17.625	19.375	0.750	448	492	19	25003-3741	23-L	18.000	19.500	0.750	457	495	19
24703-0314	59	17.625	19.375	0.750	448	492	19	24610-2691	26-L	18.000	19.500	0.750	457	495	19
24700-0314	59	17.625	19.375	0.750	448	492	19	21086-3741	53-L	18.000	19.500	0.750	457	495	19
21238-6850	64-L	17.625	19.625	0.688	448	498	17	21767-3741	62	18.000	19.500	0.750	457	495	19
25003-9421	23-L	17.625	19.625	0.813	448	498	21	25003-8691	23-L	18.000	19.500	0.813	457	495	21
21432-2015	142-L	17.688	19.188	1.000	449	487	25	21432-7615	142-L	18.000	19.500	1.000	457	495	25
25003-3846	23-L	17.710	19.685	0.812	450	500	21	22627-7404	53R2-L	18.000	19.500	1.250	457	495	32
25003-3806	23-L	17.713	19.625	0.812	450	498	21	25001-4207	21-L	18.000	19.750	0.750	457	502	19
25010-1179	23-L	17.716	19.685	0.813	450	500	21	24700-0323	59	18.000	19.750	0.750	457	502	19
25003-1179	23-L	17.716	19.685	0.813	450	500	21	25010-7413	23-L	18.000	19.750	0.812	457	502	21
24610-6120	26-L	17.716	19.685	0.866	450	500	22	25002-7413	21-L	18.000	19.750	0.813	457	502	21
25003-9479	23-L	17.716	19.716	0.812	450	501	21	25003-7413	23-L	18.000	19.750	0.813	457	502	21
25003-0510	23-L	17.717	18.898	0.500	450	480	13	24626-0983	26-L	18.000	20.000	0.625	457	508	16
24700-3943	59	17.717	19.291	0.787	450	490	20	24600-0983	26-L	18.000	20.000	0.625	457	508	16
24736-5464	59	17.717	20.079	0.984	450	510	25	25003-4209	23-L	18.000	20.000	0.750	457	508	19
25003-9925	23-L	17.717	19.409	0.787	450	493	20	24700-0325	59	18.000	20.000	0.750	457	508	19
24670-5464	26HR-L	17.717	20.079	.984	450	510	25	24707-0325	59	18.000	20.000	0.750	457	508	19

All dimensions are in inches. Preferred sizes are indicated with **bold** type face.  
 Sizes listed are for standard nitrile elements, except Models 25 and 62 which have PTFE elements. Other material available on inquiry only.

## Oil Seals by Model Number

Product Code	Model	Inches			MM			Product Code	Model	Inches			MM		
		ID	OD	Width	ID	OD	Width			ID	OD	Width	ID	OD	Width
21238-4209	64-L	18.000	20.000	0.750	457	508	19	21238-4213	64-L	18.375	19.875	0.688	467	505	17
25010-6399	23-L	18.000	20.000	0.812	457	508	21	21852-4213	64-L	18.375	19.875	0.688	467	505	17
24610-3280	26-L	18.000	20.000	0.812	457	508	21	25003-6132	23-L	18.375	19.875	0.750	467	505	19
25001-6399	21-L	18.000	20.000	0.813	457	508	21	21238-7103	64-L	18.375	19.938	0.688	467	506	17
25003-6399	23-L	18.000	20.000	0.813	457	508	21	21238-4215	64-L	18.375	20.000	0.750	467	508	19
25006-6399	23-L	18.000	20.000	0.813	457	508	21	21852-4215	64-L	18.375	20.000	0.750	467	508	19
21247-4210	64-L	18.000	20.000	0.875	457	508	22	21247-3393	64-L	18.375	20.079	0.750	467	510	19
21238-4210	64-L	18.000	20.000	0.875	457	508	22	25003-6740	23-L	18.375	20.375	0.813	467	518	21
21852-4210	64-L	18.000	20.000	0.875	457	508	22	21238-6740	64-L	18.375	20.375	0.813	467	518	21
21243-4210	64-L	18.000	20.000	0.875	457	508	22	24602-2002	26-L	18.386	20.079	0.787	467	510	20
24626-3742	26-L	18.000	20.000	1.000	457	508	25	25001-2087	21-L	18.437	20.500	0.813	468	521	21
24600-3742	26-L	18.000	20.000	1.000	457	508	25	25003-2697	23-L	18.449	19.449	0.500	469	494	13
24610-3742	26-L	18.000	20.000	1.000	457	508	25	25003-5820	23-L	18.500	19.500	0.500	470	495	13
21086-3742	53-L	18.000	20.000	1.000	457	508	25	21432-6737	142-L	18.500	19.625	1.250	470	498	32
22627-9423	53R2-L	18.000	20.000	1.750	457	508	44	21238-3768	64-L	18.500	20.000	0.687	470	508	17
22897-6793	53T2-L	18.000	20.000	1.813	457	508	46	25006-9881	23-L	18.500	20.000	0.750	470	508	19
21086-7664	53-L	18.000	20.250	1.000	457	514	25	24602-0338	26-L	18.500	20.000	0.750	470	508	19
24700-5617	59	18.000	20.250	1.000	457	514	25	25003-7059	23-L	18.500	20.500	0.750	470	521	19
21238-3752	64-L	18.000	20.500	0.875	457	521	22	24660-7059	26HR-L	18.500	20.500	0.750	470	521	19
24627-1973	26-L	18.000	21.000	0.750	457	533	19	24620-7059	26R1-L	18.500	20.500	0.750	470	521	19
25003-4008	23-L	18.031	19.882	0.812	458	505	21	24600-7059	26-L	18.500	20.500	0.750	470	521	19
25003-5432	23-L	18.031	20.031	0.813	458	509	21	24702-7059	59	18.500	20.500	0.750	470	521	19
25003-5769	23-L	18.062	20.062	0.812	459	510	21	24700-7059	59	18.500	20.500	0.750	470	521	19
24627-4508	26-L	18.110	19.685	0.787	460	500	20	25010-6408	23-L	18.500	20.500	0.812	470	521	21
24700-4508	59	18.110	19.685	0.787	460	500	20	25138-6408	23-L	18.500	20.500	0.813	470	521	21
24707-4508	59	18.110	19.685	0.787	460	500	20	25003-6408	23-L	18.500	20.500	0.813	470	521	21
24736-4508	59	18.110	19.685	0.787	460	500	20	25145-6408	23-L	18.500	20.500	0.813	470	521	21
25010-0518	23-L	18.110	19.844	0.787	460	504	20	25006-6408	23-L	18.500	20.500	0.813	470	521	21
25004-1237	23-L	18.110	20.078	0.787	460	510	20	24702-4216	59	18.500	20.500	0.875	470	521	22
24700-4486	59	18.110	20.078	0.866	460	510	22	24700-4216	59	18.500	20.500	0.875	470	521	22
25003-1237	23-L	18.110	20.079	0.787	460	510	20	21247-4216	64-L	18.500	20.500	0.875	470	521	22
24600-4486	26-L	18.110	20.079	0.866	460	510	22	21773-4216	64-L	18.500	20.500	0.875	470	521	22
25003-5431	23-L	18.110	20.110	0.813	460	511	21	21222-4216	64-L	18.500	20.500	0.875	470	521	22
25003-0518	23-L	18.110	19.843	0.787	460	504	20	21238-4216	64-L	18.500	20.500	0.875	470	521	22
24715-4486	59	18.110	20.079	0.866	460	510	22	21243-4216	64-L	18.500	20.500	0.875	470	521	22
25003-5680	23-L	18.125	19.625	0.750	460	498	19	21852-4216	64-L	18.500	20.500	0.875	470	521	22
21432-2263	142-L	18.125	19.625	1.000	460	498	25	26188-4216	88NS-L	18.500	20.500	0.875	470	521	22
25003-1115	23-L	18.125	19.750	0.750	460	502	19	26088-4216	88-L	18.500	20.500	0.875	470	521	22
21432-8440	142-L	18.250	19.375	1.250	464	492	32	21247-2616	64-L	18.500	21.000	0.875	470	533	22
21247-3757	64-L	18.250	19.750	0.687	464	502	17	25003-9881	23-L	18.504	20.000	0.748	470	508	19
21238-3757	64-L	18.250	19.750	0.688	464	502	17	25003-8695	23-L	18.504	20.472	0.740	470	520	19
25018-4211	21-L	18.250	19.750	0.750	464	502	19	24772-4255	59	18.504	20.866	0.984	470	530	25
25001-4211	21-L	18.250	19.750	0.750	464	502	19	24700-4255	59	18.504	20.866	0.984	470	530	25
25010-4211	23-L	18.250	19.750	0.750	464	502	19	25003-4732	23-L	18.504	20.079	0.787	470	510	20
25003-4211	23-L	18.250	19.750	0.750	464	502	19	25003-5506	23-L	18.563	19.562	0.500	472	497	13
25004-4211	23-L	18.250	19.750	0.750	464	502	19	25003-3807	23-L	18.625	20.125	0.750	473	511	19
24700-0330	59	18.250	19.750	0.750	464	502	19	25003-5130	23-L	18.625	20.625	0.812	473	524	21
25003-4212	23-L	18.250	19.875	0.750	464	505	19	25054-9979	23-L	18.750	19.750	0.500	476	502	13
25004-4212	23-L	18.250	19.875	0.750	464	505	19	25003-9979	23-L	18.750	19.750	0.500	476	502	13
25004-3845	23-L	18.250	19.938	0.750	464	506	19	25003-2337	23-L	18.750	20.250	0.500	476	514	13
24600-7618	26-L	18.250	20.250	0.812	464	514	21	25010-4217	23-L	18.750	20.250	0.750	476	514	19
25003-7618	23-L	18.250	20.250	0.813	464	514	21	25003-4217	23-L	18.750	20.250	0.750	476	514	19
25003-3066	23-L	18.375	19.375	0.500	467	492	13	24700-0340	59	18.750	20.250	0.750	476	514	19
25003-4213	23-L	18.375	19.875	0.688	467	505	17	25001-9477	21-L	18.750	20.250	0.813	476	514	21
24700-0333	59	18.375	19.875	0.688	467	505	17	25003-9477	23-L	18.750	20.250	0.813	476	514	21
21247-4213	64-L	18.375	19.875	0.688	467	505	17	21432-7607	142-L	18.750	20.250	1.000	476	514	25

All dimensions are in inches. Preferred sizes are indicated with **bold** type face.

Sizes listed are for standard nitrile elements, except Models 25 and 62 which have PTFE elements. Other material available on inquiry only.

## Oil Seals by Model Number

Product Code	Model	Inches			MM			Product Code	Model	Inches			MM		
		ID	OD	Width	ID	OD	Width			ID	OD	Width	ID	OD	Width
25045-9561	23-L	18.750	20.750	0.750	476	527	19	25003-8719	23-L	19.125	21.125	0.813	486	537	21
24700-0343	59	18.750	20.750	0.750	476	527	19	24700-4879	59	19.125	21.125	0.813	486	537	21
25003-9940	23-L	18.750	20.750	0.813	476	527	21	25003-2728	23-L	19.250	20.250	0.500	489	514	13
24610-5427	26-L	18.750	20.750	0.875	476	527	22	25003-4617	23-L	19.250	20.750	0.750	489	527	19
25003-9742	23-L	18.875	20.875	0.813	479	530	21	24715-0348	59	19.250	20.750	0.750	489	527	19
24709-0344	59	18.897	20.464	0.787	480	520	20	21238-4617	64-L	19.250	20.750	0.750	489	527	19
21852-7281	64-L	18.897	20.472	0.787	480	520	20	21852-4617	64-L	19.250	20.750	0.750	489	527	19
21238-7281	64-L	18.898	20.472	0.787	480	520	20	24700-0349	59	19.250	21.000	0.750	489	533	19
25003-8299	23-L	18.898	20.866	0.787	480	530	20	21247-5485	64-L	19.250	21.250	0.750	489	540	19
25006-8299	23-L	18.898	20.866	0.787	480	530	20	21238-5485	64-L	19.250	21.250	0.750	489	540	19
24700-1247	59	18.898	20.866	0.787	480	530	20	25003-6079	23-L	19.250	21.250	0.813	489	540	21
24702-1247	59	18.898	20.866	0.787	480	530	20	24600-4856	26-L	19.291	21.260	0.866	490	540	22
25003-0639	23-L	18.898	20.866	1.047	480	530	27	24700-3133	59	19.291	20.866	0.787	490	530	20
25003-7281	23-L	18.898	20.472	0.787	480	520	20	24707-3133	59	19.291	20.866	0.787	490	530	20
24600-7281	26-L	18.898	20.472	0.787	480	520	20	24756-3133	59	19.291	20.866	0.787	490	530	20
25003-3747	23-L	18.898	20.866	0.591	480	530	15	25003-1298	23-L	19.291	21.260	0.787	490	540	20
25045-8299	23-L	18.898	20.866	0.787	480	530	20	24700-5079	59	19.375	21.000	0.750	492	533	19
25015-8299	23-L	18.898	20.866	0.787	480	530	20	24700-0352	59	19.375	21.000	0.812	492	533	21
25003-5099	23-L	18.938	20.938	0.813	481	532	21	25003-9734	23-L	19.375	21.375	0.813	492	543	21
25006-5099	23-L	18.938	20.938	0.813	481	532	21	25006-9734	23-L	19.375	21.375	0.813	492	543	21
25003-5158	23-L	19.000	20.000	0.500	483	508	13	25004-9734	23-L	19.375	21.375	0.813	492	543	21
25003-4673	23-L	19.000	20.125	0.547	483	511	14	25003-3242	23-L	19.449	21.417	0.812	494	544	21
25003-9644	23-L	19.000	20.204	0.531	483	513	13	25003-5262	23-L	19.500	20.500	0.500	495	521	13
21333-4353	143	19.000	20.312	0.781	483	516	20	25003-3779	23-L	19.500	21.000	0.750	495	533	19
25003-4218	23-L	19.000	20.500	0.750	483	521	19	21238-3779	64-L	19.500	21.000	0.750	495	533	19
25004-4218	23-L	19.000	20.500	0.750	483	521	19	25003-5699	23-L	19.500	21.250	0.813	495	540	21
24751-0345	59G1	19.000	20.500	0.750	483	521	19	24700-0355	59	19.500	21.500	0.750	495	546	19
24702-0345	59	19.000	20.500	0.750	483	521	19	26081-6980	87-L	19.500	21.500	0.750	495	546	19
24715-0345	59	19.000	20.500	0.750	483	521	19	26080-6980	87-L	19.500	21.500	0.750	495	546	19
24700-0345	59	19.000	20.500	0.750	483	521	19	26086-6980	88-L	19.500	21.500	0.750	495	546	19
21247-4218	64-L	19.000	20.500	0.750	483	521	19	26088-6980	88-L	19.500	21.500	0.750	495	546	19
21773-4218	64-L	19.000	20.500	0.750	483	521	19	25001-8446	21-L	19.500	21.500	0.812	495	546	21
21226-4218	64-L	19.000	20.500	0.750	483	521	19	25003-8446	23-L	19.500	21.500	0.813	495	546	21
21238-4218	64-L	19.000	20.500	0.750	483	521	19	25006-8446	23-L	19.500	21.500	0.813	495	546	21
21243-4218	64-L	19.000	20.500	0.750	483	521	19	24600-4221	26-L	19.500	21.500	0.875	495	546	22
21852-4218	64-L	19.000	20.500	0.750	483	521	19	24610-4221	26-L	19.500	21.500	0.875	495	546	22
26081-4218	87-L	19.000	20.500	0.750	483	521	19	21247-4221	64-L	19.500	21.500	0.875	495	546	22
26080-4218	87-L	19.000	20.500	0.750	483	521	19	21238-4221	64-L	19.500	21.500	0.875	495	546	22
26086-4218	88-L	19.000	20.500	0.750	483	521	19	21243-4221	64-L	19.500	21.500	0.875	495	546	22
26088-4218	88-L	19.000	20.500	0.750	483	521	19	21852-4221	64-L	19.500	21.500	0.875	495	546	22
25003-9115	23-L	19.000	21.000	0.750	483	533	19	24700-4646	59	19.500	21.750	0.875	495	552	22
25006-9115	23-L	19.000	21.000	0.750	483	533	19	25003-0753	23-L	19.625	21.079	0.531	498	535	13
25045-2012	23-L	19.000	21.000	0.781	483	533	20	25003-2620	23-L	19.625	21.080	0.500	498	535	13
25045-6508	23-L	19.000	21.000	0.812	483	533	21	25045-1780	23-L	19.625	21.125	0.500	498	537	13
25001-6508	21-L	19.000	21.000	0.813	483	533	21	25003-1780	23-L	19.625	21.125	0.500	498	537	13
25018-6508	21-L	19.000	21.000	0.813	483	533	21	25003-4678	23-L	19.625	21.625	0.813	498	549	21
25003-6508	23-L	19.000	21.000	0.813	483	533	21	24700-2654	59	19.635	21.635	0.813	499	550	21
25006-6508	23-L	19.000	21.000	0.813	483	533	21	24600-2504	26-L	19.685	20.866	0.590	500	530	15
25004-6508	23-L	19.000	21.000	0.813	483	533	21	25010-3960	23-L	19.685	21.260	0.787	500	540	20
24627-6697	26-L	19.000	21.000	0.813	483	533	21	24715-4047	59	19.685	21.260	0.787	500	540	20
24700-6508	59	19.000	21.000	0.813	483	533	21	25003-2484	23-L	19.685	21.457	0.787	500	545	20
24610-0346	26-L	19.000	21.000	0.875	483	533	22	26080-1383	87-L	19.685	21.654	0.787	500	550	20
24700-0346	59	19.000	21.000	0.875	483	533	22	26086-1383	88-L	19.685	21.654	0.787	500	550	20
21238-4219	64-L	19.000	21.000	0.875	483	533	22	25003-8634	23-L	19.685	21.685	0.812	500	551	21
21852-4219	64-L	19.000	21.000	0.875	483	533	22	24700-4047	59	19.685	21.260	0.787	500	540	20
25003-5271	23-L	19.125	20.125	0.500	486	511	13	24769-5949	59	19.685	21.654	0.709	500	550	18

All dimensions are in inches. Preferred sizes are indicated with **bold** type face.  
 Sizes listed are for standard nitrile elements, except Models 25 and 62 which have PTFE elements. Other material available on inquiry only.

## Oil Seals by Model Number

Product Code	Model	Inches			MM			Product Code	Model	Inches			MM		
		ID	OD	Width	ID	OD	Width			ID	OD	Width	ID	OD	Width
24715-5949	59	19.685	21.654	0.709	500	550	18	25006-4230	23-L	20.000	21.750	0.813	508	552	21
26081-1383	87-L	19.685	21.654	0.787	500	550	20	25135-4370	23-L	20.000	21.968	0.767	508	558	19
26099-1383	87-L	19.685	21.654	0.787	500	550	20	25010-1535	23-L	20.000	21.968	0.787	508	558	20
26188-1383	88NS-L	19.685	21.654	0.787	500	550	20	25135-1535	23-L	20.000	21.968	0.787	508	558	20
26088-1383	88-L	19.685	21.654	0.787	500	550	20	24602-4231	26-L	20.000	22.000	0.625	508	559	16
24715-1246	59	19.685	21.654	0.866	500	550	22	24700-4231	59	20.000	22.000	0.625	508	559	16
24700-1246	59	19.685	21.654	0.866	500	550	22	26082-4231	87-L	20.000	22.000	0.625	508	559	16
24702-1246	59	19.685	21.654	0.866	500	550	22	25003-7212	23-L	20.000	22.000	0.750	508	559	19
25003-5904	23-L	19.688	21.187	0.750	500	538	19	24627-1977	26-L	20.000	22.000	0.750	508	559	19
25003-2439	23-L	19.688	21.688	0.812	500	551	21	24700-1977	59	20.000	22.000	0.750	508	559	19
25003-4525	23-L	19.750	20.750	0.500	502	527	13	24702-1977	59	20.000	22.000	0.750	508	559	19
25003-1038	23-L	19.750	21.250	0.750	502	540	19	25010-6400	23-L	20.000	22.000	0.812	508	559	21
25001-6426	21-L	19.750	21.750	0.813	502	552	21	25045-6400	23-L	20.000	22.000	0.813	508	559	21
25003-6426	23-L	19.750	21.750	0.813	502	552	21	25003-6400	23-L	20.000	22.000	0.813	508	559	21
24700-0357	59	19.750	21.750	0.875	502	552	22	25006-6400	23-L	20.000	22.000	0.813	508	559	21
21238-4228	64-L	19.750	21.750	0.875	502	552	22	24627-6400	26-L	20.000	22.000	0.813	508	559	21
21852-4228	64-L	19.750	21.750	0.875	502	552	22	24700-9477	59	20.000	22.000	0.875	508	559	22
21243-4228	64-L	19.750	21.750	0.875	502	552	22	21937-4237	64-L	20.000	22.000	0.875	508	559	22
25001-1055	21-L	19.750	22.000	0.813	502	559	21	21238-4237	64-L	20.000	22.000	0.875	508	559	22
21238-7400	64-L	19.750	22.125	0.875	502	562	22	21852-4237	64-L	20.000	22.000	0.875	508	559	22
21773-7400	64-L	19.750	22.125	0.875	502	562	22	21086-3749	53-L	20.000	22.000	1.000	508	559	25
25003-5291	23-L	19.875	21.875	0.813	505	556	21	24715-2981	59	20.000	22.000	1.000	508	559	25
25001-1056	21-L	19.875	22.000	0.813	505	559	21	24717-2981	59	20.000	22.000	1.000	508	559	25
21333-4554	143	19.880	21.192	0.781	505	538	20	24700-0364	59	20.000	22.126	1.024	508	562	26
25003-5849	23-L	19.881	21.881	0.812	505	556	21	21238-3790	64-L	20.000	22.500	0.875	508	572	22
24715-0361	59	19.938	21.688	0.625	506	551	16	25003-7446	23-L	20.032	21.654	0.813	509	550	21
24700-3220	59	19.938	21.688	0.625	506	551	16	21852-7266	64-L	20.047	24.016	0.787	509	610	20
21247-4233	64-L	19.938	21.688	0.625	506	551	16	25003-9801	23-L	20.063	22.062	0.813	510	560	21
21238-4233	64-L	19.938	21.688	0.625	506	551	16	25003-5802	23-L	20.078	22.078	0.813	510	561	21
21852-4233	64-L	19.938	21.688	0.625	506	551	16	24610-5688	26-L	20.079	21.260	0.591	510	540	15
25010-0122	23-L	19.943	21.250	0.500	507	540	13	24600-5228	26-L	20.079	21.260	0.866	510	540	22
25010-0411	23-L	19.943	21.750	0.500	507	552	13	25003-1181	23-L	20.111	22.111	0.813	511	562	21
25010-0414	23-L	19.974	21.000	0.375	507	533	10	25003-6718	23-L	20.125	22.125	0.750	511	562	19
24600-2511	26-L	19.983	21.125	0.625	508	537	16	25011-6710	23-L	20.125	22.125	0.812	511	562	21
25003-2322	23-L	20.000	20.938	0.500	508	532	13	25010-6710	23-L	20.125	22.125	0.813	511	562	21
25054-8421	23-L	20.000	21.000	0.500	508	533	13	25003-6710	23-L	20.125	22.125	0.813	511	562	21
25003-8421	23-L	20.000	21.000	0.500	508	533	13	25144-6710	23-L	20.125	22.125	0.813	511	562	21
25006-8421	23-L	20.000	21.000	0.500	508	533	13	24700-6105	59	20.143	22.250	0.875	512	565	22
21432-7706	142-L	20.000	21.125	1.250	508	537	32	21333-2097	143	20.213	21.525	0.781	513	547	20
25010-2505	23-L	20.000	21.250	0.625	508	540	16	25003-9478	23-L	20.250	21.250	0.500	514	540	13
25003-2505	23-L	20.000	21.250	0.625	508	540	16	25003-4239	23-L	20.250	21.750	0.750	514	552	19
24700-3539	59	20.000	21.250	0.625	508	540	16	21247-4239	64-L	20.250	21.750	0.750	514	552	19
24700-0362	59	20.000	21.500	0.625	508	546	16	21238-4239	64-L	20.250	21.750	0.750	514	552	19
24702-0362	59	20.000	21.500	0.625	508	546	16	21852-4239	64-L	20.250	21.750	0.750	514	552	19
24700-2229	59	20.000	21.500	0.688	508	546	17	26188-4239	88NS-L	20.250	21.750	0.750	514	552	19
25003-4235	23-L	20.000	21.500	0.750	508	546	19	26088-4239	88-L	20.250	21.750	0.750	514	552	19
24610-1013	26-L	20.000	21.500	0.750	508	546	19	21238-8231	64-L	20.250	22.245	0.875	514	565	22
21247-4235	64-L	20.000	21.500	0.750	508	546	19	25003-4926	23-L	20.250	22.250	0.813	514	565	21
21238-4235	64-L	20.000	21.500	0.750	508	546	19	24700-0367	59	20.250	22.250	0.875	514	565	22
21852-4235	64-L	20.000	21.500	0.750	508	546	19	21238-4240	64-L	20.250	22.250	0.875	514	565	22
21243-4235	64-L	20.000	21.500	0.750	508	546	19	21852-4240	64-L	20.250	22.250	0.875	514	565	22
24700-2126	59	20.000	21.500	0.875	508	546	22	24700-6554	59	20.250	22.500	0.750	514	572	19
25135-1533	23-L	20.000	21.574	0.787	508	548	20	24751-0369	59G1	20.250	22.500	0.875	514	572	22
24700-0363	59	20.000	21.750	0.750	508	552	19	24700-0369	59	20.250	22.500	0.875	514	572	22
21238-4236	64-L	20.000	21.750	0.750	508	552	19	24600-5493	26-L	20.276	21.850	0.787	515	555	20
25003-4230	23-L	20.000	21.750	0.813	508	552	21	25003-2652	23-L	20.375	22.188	0.812	518	564	21

All dimensions are in inches. Preferred sizes are indicated with **bold** type face. Sizes listed are for standard nitrile elements, except Models 25 and 62 which have PTFE elements. Other material available on inquiry only.



## Oil Seals by Model Number

Product Code	Model	Inches			MM			Product Code	Model	Inches			MM		
		ID	OD	Width	ID	OD	Width			ID	OD	Width	ID	OD	Width
25003-3931	23-L	20.385	21.500	0.562	518	546	14	26088-4248	88-L	20.750	22.750	0.875	527	578	22
25003-3915	23-L	20.385	21.500	0.750	518	546	19	26090-4248	88-L	20.750	22.750	0.875	527	578	22
24700-0370	59	20.438	22.500	0.750	519	572	19	21086-4249	53-L	20.750	22.750	1.000	527	578	25
21238-4242	64-L	20.438	22.500	0.813	519	572	21	22627-4491	53R2-L	20.750	22.750	1.750	527	578	44
25003-9987	23-L	20.458	21.458	0.375	520	545	10	25003-9392	23-L	20.827	22.827	0.812	529	580	21
25003-5654	23-L	20.469	21.969	0.750	520	558	19	26081-2388	87-L	20.866	22.441	0.787	530	570	20
25045-0935	23-L	20.470	22.470	0.812	520	571	21	24702-0375	59	20.866	22.835	0.787	530	580	20
25003-0935	23-L	20.470	22.470	0.813	520	571	21	21238-9744	23-L	20.866	22.866	0.813	530	581	21
25003-6830	23-L	20.472	21.972	0.750	520	558	19	24700-5438	59	20.866	22.441	0.787	530	570	20
24700-4764	59	20.472	22.205	0.787	520	564	20	26097-2388	87-L	20.866	22.441	0.787	530	570	20
25063-8294	21-L	20.472	22.441	0.787	520	570	20	25003-5761	23-L	20.866	22.638	0.811	530	575	21
25003-3053	23-L	20.472	22.472	0.811	520	571	21	25003-1911	23-L	20.866	22.835	0.787	530	580	20
24700-6497	59	20.472	22.835	0.984	520	580	25	25006-1911	23-L	20.866	22.835	0.787	530	580	20
24756-6497	59	20.472	22.835	0.984	520	580	25	21238-4244	64-L	20.866	22.835	0.827	530	580	21
24700-4525	59	20.472	22.205	0.866	520	564	22	24600-3667	26-L	20.866	22.835	0.866	530	580	22
25003-9985	23-L	20.477	21.477	0.375	520	546	10	24700-3667	59	20.866	22.835	0.866	530	580	22
25003-9983	23-L	20.495	21.495	0.375	521	546	10	24700-3535	59	20.866	23.228	0.984	530	590	25
25003-9859	23-L	20.500	21.500	0.469	521	546	12	25003-9276	23-L	20.875	22.875	0.813	530	581	21
24600-2822	26-L	20.500	21.500	0.469	521	546	12	21238-4250	64-L	20.875	22.875	0.875	530	581	22
25003-8869	23-L	20.500	21.500	0.500	521	546	13	21247-6417	64-L	20.875	23.228	0.875	530	590	22
21333-3451	143	20.500	21.812	0.781	521	554	20	21238-6417	64-L	20.875	23.228	0.875	530	590	22
25003-2653	23-L	20.500	22.000	0.625	521	559	16	24627-6474	26-L	20.906	24.000	0.750	531	610	19
25003-4619	23-L	20.500	22.000	0.750	521	559	19	24700-5440	59	20.945	22.520	0.787	532	572	20
24715-0371	59	20.500	22.000	0.750	521	559	19	25010-0410	23-L	20.974	22.220	0.500	533	564	13
24707-0371	59	20.500	22.000	0.750	521	559	19	25010-9998	23-L	20.991	22.125	0.563	533	562	14
24736-0371	59	20.500	22.000	0.750	521	559	19	25010-0412	23-L	20.992	22.000	0.375	533	559	10
24702-0371	59	20.500	22.000	0.750	521	559	19	25003-4940	23-L	21.000	22.000	0.500	533	559	13
21247-4619	64-L	20.500	22.000	0.750	521	559	19	21432-3804	142-L	21.000	22.125	1.250	533	562	32
21773-4619	64-L	20.500	22.000	0.750	521	559	19	24627-6189	26-L	21.000	22.181	0.591	533	563	15
21226-4619	64-L	20.500	22.000	0.750	521	559	19	21333-3505	143	21.000	22.312	0.781	533	567	20
21238-4619	64-L	20.500	22.000	0.750	521	559	19	25003-5259	23-L	21.000	22.500	0.750	533	572	19
21852-4619	64-L	20.500	22.000	0.750	521	559	19	25006-5259	23-L	21.000	22.500	0.750	533	572	19
21243-4619	64-L	20.500	22.000	0.750	521	559	19	25004-5259	23-L	21.000	22.500	0.750	533	572	19
21238-4245	64-L	20.500	22.250	0.813	521	565	21	21238-5259	64-L	21.000	22.500	0.750	533	572	19
25001-5055	21-L	20.500	22.500	0.813	521	572	21	25001-5312	21-L	21.000	22.750	0.750	533	578	19
25003-5055	23-L	20.500	22.500	0.813	521	572	21	25003-5312	23-L	21.000	22.750	0.750	533	578	19
24610-4246	26-L	20.500	22.500	0.875	521	572	22	24700-0381	59	21.000	22.750	0.750	533	578	19
24715-4246	59	20.500	22.500	0.875	521	572	22	25003-2775	23-L	21.000	22.760	0.750	533	578	19
24700-4246	59	20.500	22.500	0.875	521	572	22	24700-0382	59	21.000	23.000	0.625	533	584	16
24736-4246	59	20.500	22.500	0.875	521	572	22	24716-0382	59	21.000	23.000	0.625	533	584	16
21247-4246	64-L	20.500	22.500	0.875	521	572	22	24747-0382	59	21.000	23.000	0.625	533	584	16
21238-4246	64-L	20.500	22.500	0.875	521	572	22	24707-0382	59	21.000	23.000	0.625	533	584	16
21840-4246	64-L	20.500	22.500	0.875	521	572	22	24736-0382	59	21.000	23.000	0.625	533	584	16
21243-4246	64-L	20.500	22.500	0.875	521	572	22	25003-5619	23-L	21.000	23.000	0.750	533	584	19
21852-4246	64-L	20.500	22.500	0.875	521	572	22	24702-1991	59	21.000	23.000	0.750	533	584	19
26088-4246	88-L	20.500	22.500	0.875	521	572	22	24715-1991	59	21.000	23.000	0.750	533	584	19
21238-6287	64-L	20.500	22.750	0.875	521	578	22	24700-1991	59	21.000	23.000	0.750	533	584	19
25003-5708	23-L	20.516	22.516	0.812	521	572	21	24747-1991	59	21.000	23.000	0.750	533	584	19
25001-9893	21-L	20.625	22.625	0.812	524	575	21	26188-5619	88NS-L	21.000	23.000	0.750	533	584	19
25003-9893	23-L	20.625	22.625	0.813	524	575	21	26086-5619	88-L	21.000	23.000	0.750	533	584	19
25003-0839	23-L	20.750	22.250	0.750	527	565	19	26088-5619	88-L	21.000	23.000	0.750	533	584	19
24700-0373	59	20.750	22.750	0.750	527	578	19	25010-6535	23-L	21.000	23.000	0.813	533	584	21
25003-7148	23-L	20.750	22.750	0.813	527	578	21	25045-6535	23-L	21.000	23.000	0.813	533	584	21
24610-3773	26-L	20.750	22.750	0.875	527	578	22	25003-6535	23-L	21.000	23.000	0.813	533	584	21
21238-4248	64-L	20.750	22.750	0.875	527	578	22	24610-6535	26-L	21.000	23.000	0.813	533	584	21
21852-4248	64-L	20.750	22.750	0.875	527	578	22	24627-1991	26-L	21.000	23.000	0.875	533	584	22

All dimensions are in inches. Preferred sizes are indicated with **bold** type face. Sizes listed are for standard nitrile elements, except Models 25 and 62 which have PTFE elements. Other material available on inquiry only.

## Oil Seals by Model Number

Product Code	Model	Inches			MM			Product Code	Model	Inches			MM		
		ID	OD	Width	ID	OD	Width			ID	OD	Width	ID	OD	Width
24627-5800	26-L	21.000	23.000	0.875	533	584	22	25002-7407	21-L	21.500	23.500	0.813	546	597	21
24610-5800	26-L	21.000	23.000	0.875	533	584	22	25003-7407	23-L	21.500	23.500	0.813	546	597	21
21247-4253	64-L	21.000	23.000	0.875	533	584	22	25004-7407	23-L	21.500	23.500	0.813	546	597	21
21255-4253	64-L	21.000	23.000	0.875	533	584	22	21247-7407	64-L	21.500	23.500	0.813	546	597	21
21773-4253	64-L	21.000	23.000	0.875	533	584	22	21238-7407	64-L	21.500	23.500	0.813	546	597	21
21222-4253	64-L	21.000	23.000	0.875	533	584	22	21773-7407	64-L	21.500	23.500	0.813	546	597	21
21238-4253	64-L	21.000	23.000	0.875	533	584	22	21247-4259	64-L	21.500	23.500	0.875	546	597	22
21243-4253	64-L	21.000	23.000	0.875	533	584	22	21238-4259	64-L	21.500	23.500	0.875	546	597	22
21852-4253	64-L	21.000	23.000	0.875	533	584	22	21243-4259	64-L	21.500	23.500	0.875	546	597	22
21238-4251	64-L	21.000	23.250	0.812	533	591	21	21852-4259	64-L	21.500	23.500	0.875	546	597	22
21238-9772	64-L	21.000	23.500	0.875	533	597	22	21238-6493	64-L	21.500	23.625	0.875	546	600	22
24700-5452	59	21.063	22.638	0.787	535	575	20	21238-0569	64-L	21.500	23.750	0.875	546	603	22
25003-3760	23-L	21.125	22.125	0.500	537	562	13	21238-4261	64-L	21.625	23.375	0.750	549	594	19
25003-8946	23-L	21.250	22.250	0.500	540	565	13	25003-5936	23-L	21.625	23.625	0.813	549	600	21
25003-0483	23-L	21.250	22.637	0.590	540	575	15	24700-0395	59	21.625	23.625	0.875	549	600	22
25003-5795	23-L	21.250	22.750	0.750	540	578	19	21238-4263	64-L	21.625	23.625	0.875	549	600	22
24700-0386	59	21.250	23.000	0.750	540	584	19	21086-4264	53-L	21.625	23.625	1.000	549	600	25
24700-0387	59	21.250	23.250	0.625	540	591	16	21840-4264	64-L	21.625	23.625	1.000	549	600	25
24744-0387	59	21.250	23.250	0.625	540	591	16	25003-5258	23-L	21.653	23.153	0.750	550	588	19
25003-2058	23-L	21.250	23.250	0.750	540	591	19	24715-2724	59	21.654	23.622	0.866	550	600	22
24700-1992	59	21.250	23.250	0.750	540	591	19	24700-2724	59	21.654	23.622	0.866	550	600	22
25003-9391	23-L	21.250	23.250	0.813	540	591	21	24715-4514	59	21.654	24.016	0.984	550	610	25
24627-4254	26-L	21.250	23.250	0.875	540	591	22	24610-2724	26-L	21.654	23.622	0.866	550	600	22
24610-4254	26-L	21.250	23.250	0.875	540	591	22	24716-2724	59	21.654	23.622	0.866	550	600	22
21247-4254	64-L	21.250	23.250	0.875	540	591	22	24765-2724	59	21.654	23.622	0.866	550	600	22
21238-4254	64-L	21.250	23.250	0.875	540	591	22	24600-5492	26-L	21.654	23.622	0.925	550	600	23
21221-4254	64-L	21.250	23.250	0.875	540	591	22	25003-3400	23-L	21.654	23.654	0.812	550	601	21
21243-4254	64-L	21.250	23.250	0.875	540	591	22	24700-4514	59	21.654	24.016	0.984	550	610	25
21852-4254	64-L	21.250	23.250	0.875	540	591	22	25003-5428	23-L	21.688	23.188	0.750	551	589	19
26088-4254	88-L	21.250	23.250	0.875	540	591	22	25003-4621	23-L	21.750	23.250	0.750	552	591	19
25003-5740	23-L	21.259	22.759	0.688	540	578	17	21238-4621	64-L	21.750	23.250	0.750	552	591	19
25003-9639	23-L	21.260	23.228	0.811	540	590	21	21243-4621	64-L	21.750	23.250	0.750	552	591	19
21238-7393	64-L	21.260	23.228	0.984	540	590	25	21432-4859	142-L	21.750	23.250	1.000	552	591	25
25003-3020	23-L	21.260	23.228	0.787	540	590	20	24700-0397	59	21.750	23.750	0.750	552	603	19
24700-4598	59	21.260	23.228	0.866	540	590	22	25003-6972	23-L	21.750	23.750	0.813	552	603	21
21432-4266	142-L	21.375	22.500	1.250	543	572	32	21238-4265	64-L	21.750	23.750	0.875	552	603	22
25003-5302	23-L	21.375	23.375	0.813	543	594	21	21773-4265	64-L	21.750	23.750	0.875	552	603	22
25003-6542	23-L	21.437	23.437	0.812	544	595	21	21852-4265	64-L	21.750	23.750	0.875	552	603	22
24700-0824	59	21.438	23.188	0.750	545	589	19	21243-4265	64-L	21.750	23.750	0.875	552	603	22
25003-5668	23-L	21.456	23.456	0.813	545	596	21	26788-4265	88NS-L	21.750	23.750	0.875	552	603	22
25003-3202	23-L	21.500	22.500	0.500	546	572	13	26188-4265	88NS-L	21.750	23.750	0.875	552	603	22
21432-9698	142-L	21.500	22.625	1.250	546	575	32	26088-4265	88-L	21.750	23.750	0.875	552	603	22
25003-6807	23-L	21.500	22.750	0.750	546	578	19	21238-8675	64-L	21.750	24.250	0.875	552	616	22
25145-6853	23-L	21.500	23.000	0.625	546	584	16	21238-4260	64-L	21.750	24.500	0.875	552	622	22
25138-6853	23-L	21.500	23.000	0.625	546	584	16	24700-0400	59	21.750	24.750	1.000	552	629	25
25003-6853	23-L	21.500	23.000	0.625	546	584	16	25003-0429	23-L	21.811	23.386	0.787	554	594	20
25003-5768	23-L	21.500	23.000	0.750	546	584	19	25003-8658	23-L	21.875	23.875	0.813	556	606	21
21432-9873	142-L	21.500	23.000	1.000	546	584	25	24600-5491	26-L	21.882	23.732	0.866	556	603	22
24715-0390	59	21.500	23.250	0.750	546	591	19	25003-0606	23-L	21.890	23.858	0.811	556	606	21
24700-0390	59	21.500	23.250	0.750	546	591	19	25003-7131	23-L	22.000	23.000	0.500	559	584	13
21238-4257	64-L	21.500	23.250	0.750	546	591	19	25003-0676	23-L	22.000	23.125	0.500	559	587	13
25005-9035	24-L	21.500	23.500	0.500	546	597	13	25001-8208	21-L	22.000	23.125	0.547	559	587	14
25003-9907	23-L	21.500	23.500	0.750	546	597	19	21432-9872	142-L	22.000	23.125	1.250	559	587	32
24700-0391	59	21.500	23.500	0.750	546	597	19	21443-9872	142-L	22.000	23.125	1.250	559	587	32
24702-0391	59	21.500	23.500	0.750	546	597	19	25045-4269	23-L	22.000	23.500	0.750	559	597	19
21243-7407	64-L	21.500	23.500	0.812	546	597	21	25003-4269	23-L	22.000	23.500	0.750	559	597	19

All dimensions are in inches. Preferred sizes are indicated with **bold** type face.

Sizes listed are for standard nitrile elements, except Models 25 and 62 which have PTFE elements. Other material available on inquiry only.

### Oil Seals by Model Number

Product Code	Model	Inches			MM			Product Code	Model	Inches			MM		
		ID	OD	Width	ID	OD	Width			ID	OD	Width	ID	OD	Width
25006-4269	23-L	22.000	23.500	0.750	559	597	19	24700-0404	59	22.250	24.250	0.875	565	616	22
24620-4269	26R1-L	22.000	23.500	0.750	559	597	19	24743-0404	59	22.250	24.250	0.875	565	616	22
24600-4269	26-L	22.000	23.500	0.750	559	597	19	24707-0404	59	22.250	24.250	0.875	565	616	22
24700-4269	59	22.000	23.500	0.750	559	597	19	21238-3764	64-L	22.250	24.250	0.875	565	616	22
21238-4269	64-L	22.000	23.500	0.750	559	597	19	21773-3764	64-L	22.250	24.250	0.875	565	616	22
21840-4269	64-L	22.000	23.500	0.750	559	597	19	21852-3764	64-L	22.250	24.250	0.875	565	616	22
21852-4269	64-L	22.000	23.500	0.750	559	597	19	26088-3764	88-L	22.250	24.250	0.875	565	616	22
21432-6796	142-L	22.000	23.500	1.000	559	597	25	25003-4863	23-L	22.320	24.320	0.813	567	618	21
25010-6291	23-L	22.000	23.750	0.812	559	603	21	24700-0406	59	22.375	24.368	0.875	568	619	22
25003-6291	23-L	22.000	23.750	0.813	559	603	21	24745-0406	59	22.375	24.368	0.875	568	619	22
24715-3256	59	22.000	23.750	0.875	559	603	22	24707-0406	59	22.375	24.368	0.875	568	619	22
24702-3256	59	22.000	23.750	0.875	559	603	22	24700-0407	59	22.375	24.375	0.875	568	619	22
24700-0401	59	22.000	24.000	0.750	559	610	19	21238-2576	64-L	22.375	24.375	0.875	568	619	22
25127-6401	21-L	22.000	24.000	0.813	559	610	21	24700-3369	59	22.375	25.250	0.875	568	641	22
25001-6401	21-L	22.000	24.000	0.813	559	610	21	24700-5377	59	22.375	25.250	1.125	568	641	29
25010-6401	23-L	22.000	24.000	0.813	559	610	21	24700-6530	59	22.438	24.000	0.750	570	610	19
25003-6401	23-L	22.000	24.000	0.813	559	610	21	24610-0409	26-L	22.438	24.438	0.875	570	621	22
25006-6401	23-L	22.000	24.000	0.813	559	610	21	24700-3769	59	22.441	24.016	0.787	570	610	20
24627-1135	26-L	22.000	24.000	0.875	559	610	22	24736-4245	59	22.441	24.409	0.866	570	620	22
24610-1135	26-L	22.000	24.000	0.875	559	610	22	24700-4245	59	22.441	24.409	0.866	570	620	22
24739-1135	59	22.000	24.000	0.875	559	610	22	24700-4241	59	22.441	24.409	0.984	570	620	25
24700-1135	59	22.000	24.000	0.875	559	610	22	25003-1305	23-L	22.500	23.375	0.375	572	594	10
24707-1135	59	22.000	24.000	0.875	559	610	22	25003-1224	23-L	22.500	23.500	0.500	572	597	13
24736-1135	59	22.000	24.000	0.875	559	610	22	24700-0411	59	22.500	24.250	0.750	572	616	19
21247-4270	64-L	22.000	24.000	0.875	559	610	22	25003-7489	23-L	22.500	24.500	0.813	572	622	21
21238-4270	64-L	22.000	24.000	0.875	559	610	22	24610-4344	26-L	22.500	24.500	0.875	572	622	22
21852-4270	64-L	22.000	24.000	0.875	559	610	22	21247-4279	64-L	22.500	24.500	0.875	572	622	22
21243-4270	64-L	22.000	24.000	0.875	559	610	22	21238-4279	64-L	22.500	24.500	0.875	572	622	22
26080-4270	87	22.000	24.000	0.875	559	610	22	21243-4279	64-L	22.500	24.500	0.875	572	622	22
26097-4270	87-L	22.000	24.000	0.875	559	610	22	21852-4279	64-L	22.500	24.500	0.875	572	622	22
26188-4270	88NS-L	22.000	24.000	0.875	559	610	22	21340-4528	143	22.500	26.562	2.000	572	675	51
26588-4270	88-L	22.000	24.000	0.875	559	610	22	24600-2501	26-L	22.598	23.779	0.590	574	604	15
21238-9082	64-L	22.000	24.250	0.812	559	616	21	24700-4518	59	22.622	25.984	0.984	575	660	25
21238-3763	64-L	22.000	24.250	0.875	559	616	22	25003-0506	23-L	22.625	24.125	0.500	575	613	13
21852-3763	64-L	22.000	24.250	0.875	559	616	22	25045-0506	23-L	22.625	24.125	0.500	575	613	13
26080-1382	87-L	22.047	23.780	0.709	560	604	18	25003-7356	23-L	22.625	24.625	0.813	575	625	21
26086-1382	88-L	22.047	23.780	0.709	560	604	18	25003-5532	23-L	22.673	24.173	0.750	576	614	19
25010-7266	23-L	22.047	24.016	0.787	560	610	20	21432-7885	142-L	22.750	23.875	1.375	578	606	35
24700-4019	59	22.047	24.016	0.870	560	610	22	25008-9432	21-L	22.750	24.330	0.578	578	618	15
21238-2394	64-L	22.047	24.016	0.875	560	610	22	24631-2628	26-L	22.750	24.330	0.578	578	618	15
26081-1382	87-L	22.047	23.780	0.709	560	604	18	25003-8526	23-L	22.750	24.750	0.813	578	629	21
26099-1382	87-L	22.047	23.780	0.709	560	604	18	24702-0416	59	22.750	24.750	0.875	578	629	22
26188-1382	88NS-L	22.047	23.780	0.709	560	604	18	24700-0416	59	22.750	24.750	0.875	578	629	22
24641-4066	26-L	22.047	23.780	0.787	560	604	20	24742-0416	59	22.750	24.750	0.875	578	629	22
24700-4066	59	22.047	23.780	0.787	560	604	20	21247-4281	64-L	22.750	24.750	0.875	578	629	22
24626-3461	26-L	22.047	24.016	0.787	560	610	20	21238-4281	64-L	22.750	24.750	0.875	578	629	22
24600-3461	26-L	22.047	24.016	0.787	560	610	20	21773-4281	64-L	22.750	24.750	0.875	578	629	22
24715-3461	59	22.047	24.016	0.787	560	610	20	21852-4281	64-L	22.750	24.750	0.875	578	629	22
24700-3461	59	22.047	24.016	0.787	560	610	20	21243-4281	64-L	22.750	24.750	0.875	578	629	22
21238-7266	64-L	22.047	24.016	0.787	560	610	20	26080-4281	87-L	22.750	24.750	0.875	578	629	22
24600-4019	26-L	22.047	24.016	0.866	560	610	22	26082-4281	87-L	22.750	24.750	0.875	578	629	22
24715-4243	59	22.047	24.409	0.984	560	620	25	21238-6843	64-L	22.750	25.000	0.875	578	635	22
24700-4243	59	22.047	24.409	0.984	560	620	25	24702-1931	59	22.750	25.500	0.875	578	648	22
25003-6191	23-L	22.062	24.062	0.813	560	611	21	26082-1083	87-L	22.750	25.500	0.875	578	648	22
25003-5254	23-L	22.125	24.125	0.812	562	613	21	26187-1083	88NS-L	22.750	25.500	0.875	578	648	22
25003-8512	23-L	22.250	24.250	0.813	565	616	21	25003-7098	23-L	22.813	24.313	0.750	579	618	19

All dimensions are in inches. Preferred sizes are indicated with **bold** type face.  
 Sizes listed are for standard nitrile elements, except Models 25 and 62 which have PTFE elements. Other material available on inquiry only.

## Oil Seals by Model Number

Product Code	Model	Inches			MM			Product Code	Model	Inches			MM		
		ID	OD	Width	ID	OD	Width			ID	OD	Width	ID	OD	Width
25003-7284	23-L	22.834	24.334	0.750	580	618	19	25045-6910	23-L	23.250	25.250	0.813	591	641	21
24715-4256	59	22.835	25.197	0.984	580	640	25	25003-6910	23-L	23.250	25.250	0.813	591	641	21
24700-4256	59	22.835	25.197	0.984	580	640	25	25006-6910	23-L	23.250	25.250	0.813	591	641	21
25003-1311	23-L	22.875	23.750	0.375	581	603	10	21238-6910	64-L	23.250	25.250	0.813	591	641	21
21432-9552	142-L	22.875	24.000	1.313	581	610	33	25003-5595	23-L	23.300	24.300	0.500	592	617	13
25003-9847	23-L	22.875	24.875	0.813	581	632	21	25003-7414	23-L	23.375	24.875	0.750	594	632	19
25003-9173	23-L	22.938	24.938	0.813	583	633	21	25003-7139	23-L	23.375	25.375	0.813	594	645	21
25006-9173	23-L	22.938	24.938	0.813	583	633	21	24700-0986	59	23.375	25.375	0.813	594	645	21
25003-3220	23-L	22.958	24.958	0.813	583	634	21	25003-0582	23-L	23.428	24.928	0.750	595	633	19
25003-6202	23-L	23.000	24.000	0.500	584	610	13	25003-5756	23-L	23.500	24.500	0.500	597	622	13
25003-7593	23-L	23.000	24.250	0.750	584	616	19	21432-9909	142-L	23.500	24.625	1.375	597	625	35
25006-4283	23-L	23.000	24.500	0.750	584	622	19	25003-6772	23-L	23.500	25.500	0.750	597	648	19
24700-0418	59	23.000	24.500	0.750	584	622	19	25001-6879	21-L	23.500	25.500	0.813	597	648	21
21247-4283	64-L	23.000	24.500	0.750	584	622	19	25003-6879	23-L	23.500	25.500	0.813	597	648	21
21221-4283	64-L	23.000	24.500	0.750	584	622	19	24610-0427	26-L	23.500	25.500	0.875	597	648	22
21227-4283	64-L	23.000	24.500	0.750	584	622	19	24700-0427	59	23.500	25.500	0.875	597	648	22
21238-4283	64-L	23.000	24.500	0.750	584	622	19	21238-4288	64-L	23.500	25.500	0.875	597	648	22
21852-4283	64-L	23.000	24.500	0.750	584	622	19	21852-4288	64-L	23.500	25.500	0.875	597	648	22
21840-4283	64-L	23.000	24.500	0.750	584	622	19	21840-4288	64-L	23.500	25.500	0.875	597	648	22
24700-0419	59	23.000	24.750	0.750	584	629	19	21243-4288	64-L	23.500	25.500	0.875	597	648	22
21238-5421	64-L	23.000	24.750	0.750	584	629	19	21086-4289	53-L	23.500	25.500	1.000	597	648	25
25001-7838	21-L	23.000	25.000	0.813	584	635	21	24700-3387	59	23.500	25.500	1.000	597	648	25
25008-7838	21-L	23.000	25.000	0.813	584	635	21	25003-0464	23-L	23.512	25.512	0.813	597	648	21
25045-7838	23-L	23.000	25.000	0.813	584	635	21	21238-4290	64-L	23.563	25.250	0.750	599	641	19
25003-7838	23-L	23.000	25.000	0.813	584	635	21	21243-4290	64-L	23.563	25.250	0.750	599	641	19
25010-7838	23-L	23.000	25.000	0.813	584	635	21	21247-4291	64-L	23.563	25.375	0.750	599	645	19
25009-7838	23-L	23.000	25.000	0.813	584	635	21	21238-4291	64-L	23.563	25.375	0.750	599	645	19
24627-3433	26-L	23.000	25.000	0.826	584	635	21	21852-4291	64-L	23.563	25.375	0.750	599	645	19
24627-0420	26-L	23.000	25.000	0.875	584	635	22	25003-5614	23-L	23.570	25.070	0.750	599	637	19
24700-0420	59	23.000	25.000	0.875	584	635	22	25003-5615	23-L	23.595	25.095	0.750	599	637	19
21222-4284	64-L	23.000	25.000	0.875	584	635	22	24610-5683	26-L	23.622	24.803	0.591	600	630	15
21238-4284	64-L	23.000	25.000	0.875	584	635	22	21247-8624	64-L	23.622	25.197	0.787	600	640	20
21852-4284	64-L	23.000	25.000	0.875	584	635	22	25003-8624	23-L	23.622	25.197	0.788	600	640	20
21243-4284	64-L	23.000	25.000	0.875	584	635	22	24700-5280	59	23.622	25.197	0.788	600	640	20
24700-0421	59	23.000	25.375	0.875	584	645	22	24700-4519	59	23.622	25.590	0.866	600	650	22
21238-4277	64-L	23.000	25.375	0.875	584	645	22	24700-5559	59	23.622	25.591	0.984	600	650	25
24700-0422	59	23.000	25.500	0.875	584	648	22	24626-5715	26	23.622	24.803	0.433	600	630	11
21247-4285	64-L	23.000	25.500	0.875	584	648	22	24600-5229	26-L	23.622	24.803	0.866	600	630	22
21238-4285	64-L	23.000	25.500	0.875	584	648	22	24718-5280	59	23.622	25.197	0.787	600	640	20
21852-4285	64-L	23.000	25.500	0.875	584	648	22	21238-8624	64-L	23.622	25.197	0.787	600	640	20
26080-4285	87-L	23.000	25.500	0.875	584	648	22	25006-6337	23-L	23.625	25.625	0.812	600	651	21
26082-4285	87-L	23.000	25.500	0.875	584	648	22	25003-6337	23-L	23.625	25.625	0.813	600	651	21
26098-2547	87-L	23.000	25.500	1.000	584	648	25	21247-4292	64-L	23.625	26.000	0.875	600	660	22
25003-3755	23-L	23.071	23.976	0.453	586	609	12	21238-4292	64-L	23.625	26.000	0.875	600	660	22
25003-7714	23-L	23.110	24.610	0.750	587	625	19	21432-9685	142-L	23.750	24.875	1.250	603	632	32
25003-8285	23-L	23.125	24.625	0.618	587	625	16	25003-7594	23-L	23.750	25.250	0.750	603	641	19
25003-8468	23-L	23.188	25.188	0.813	589	640	21	24702-3428	59	23.750	25.250	0.875	603	641	22
24700-3134	59	23.228	24.803	0.787	590	630	20	21238-6239	64-L	23.750	25.250	1.000	603	641	25
24707-3134	59	23.228	24.803	0.787	590	630	20	21852-6239	64-L	23.750	25.250	1.000	603	641	25
25003-2674	23-L	23.228	25.197	0.787	590	640	20	21840-6239	64-L	23.750	25.250	1.000	603	641	25
25003-7162	23-L	23.250	24.750	0.750	591	629	19	25003-5553	23-L	23.750	25.750	0.813	603	654	21
25045-9371	23-L	23.250	25.250	0.750	591	641	19	24610-3040	26-L	23.750	25.750	0.875	603	654	22
25003-9371	23-L	23.250	25.250	0.750	591	641	19	24618-3040	26-L	23.750	25.750	0.875	603	654	22
24626-0424	26-L	23.250	25.250	0.750	591	641	19	24700-5972	59	23.750	25.750	1.000	603	654	25
24700-0424	59	23.250	25.250	0.750	591	641	19	25021-8108	23-L	23.875	24.875	0.500	606	632	13
25001-6910	21-L	23.250	25.250	0.813	591	641	21	25045-8108	23-L	23.875	24.875	0.500	606	632	13

All dimensions are in inches. Preferred sizes are indicated with **bold** type face.

Sizes listed are for standard nitrile elements, except Models 25 and 62 which have PTFE elements. Other material available on inquiry only.

## Oil Seals by Model Number

Product Code	Model	Inches			MM			Product Code	Model	Inches			MM		
		ID	OD	Width	ID	OD	Width			ID	OD	Width	ID	OD	Width
25003-8108	23-L	23.875	24.875	0.500	606	632	13	21247-4301	64-L	24.250	26.250	0.875	616	667	22
24715-0433	59	23.875	26.000	0.875	606	660	22	21238-4301	64-L	24.250	26.250	0.875	616	667	22
24700-0433	59	23.875	26.000	0.875	606	660	22	21852-4301	64-L	24.250	26.250	0.875	616	667	22
21238-4293	64-L	23.875	26.000	0.875	606	660	22	24700-5910	59	24.250	26.250	1.000	616	667	25
25003-1294	23-L	23.900	25.100	0.750	607	638	19	24610-5782	26-L	24.250	26.750	1.000	616	679	25
25001-3254	21-L	24.000	25.000	0.500	610	635	13	25003-1977	23-L	24.375	25.625	0.625	619	651	16
25004-3254	23-L	24.000	25.000	0.500	610	635	13	25003-3210	23-L	24.375	26.375	0.750	619	670	19
21432-9336	142-L	24.000	25.000	0.750	610	635	19	24700-0439	59	24.375	26.375	0.750	619	670	19
25001-5552	21-L	24.000	25.125	0.500	610	638	13	25003-3205	23-L	24.409	25.394	0.492	620	645	12
25003-5552	23-L	24.000	25.125	0.500	610	638	13	24780-3678	59	24.409	26.378	0.866	620	670	22
21432-5870	142-L	24.000	25.125	1.250	610	638	32	24781-3678	59	24.409	26.378	0.866	620	670	22
25003-4874	23-L	24.000	25.500	0.700	610	648	18	24750-5921	59G1	24.409	26.378	0.984	620	670	25
25003-4623	23-L	24.000	25.500	0.750	610	648	19	26080-4390	87-L	24.409	26.378	0.866	620	670	22
24700-0434	59	24.000	25.500	0.750	610	648	19	21238-4302	64-L	24.437	26.000	0.750	621	660	19
21238-4623	64-L	24.000	25.500	0.750	610	648	19	21238-4304	64-L	24.438	26.437	0.750	621	671	19
21432-5440	142-L	24.000	25.500	1.000	610	648	25	21852-4304	64-L	24.438	26.437	0.750	621	671	19
24700-0435	59	24.000	26.000	0.750	610	660	19	25003-4304	23-L	24.438	26.438	0.750	621	672	19
25010-5919	23-L	24.000	26.000	0.812	610	660	21	24600-0441	26-L	24.438	26.438	0.750	621	672	19
25001-5919	21-L	24.000	26.000	0.813	610	660	21	24700-0441	59	24.438	26.438	0.750	621	672	19
25002-5919	21-L	24.000	26.000	0.813	610	660	21	25003-6335	23-L	24.438	26.438	0.813	621	672	21
25045-5919	23-L	24.000	26.000	0.813	610	660	21	21335-4035	143	24.441	25.753	0.781	621	654	20
25003-5919	23-L	24.000	26.000	0.813	610	660	21	25003-0822	23-L	24.500	25.375	0.375	622	645	10
25006-5919	23-L	24.000	26.000	0.813	610	660	21	25003-5818	23-L	24.500	25.500	0.500	622	648	13
24600-4294	26-L	24.000	26.000	0.875	610	660	22	25006-5818	23-L	24.500	25.500	0.500	622	648	13
24610-4294	26-L	24.000	26.000	0.875	610	660	22	25001-4675	21-L	24.500	25.625	0.500	622	651	13
24700-4294	59	24.000	26.000	0.875	610	660	22	25003-4675	23-L	24.500	25.625	0.500	622	651	13
24742-4294	59	24.000	26.000	0.875	610	660	22	24610-5260	26-L	24.500	25.625	0.500	622	651	13
21247-4294	64-L	24.000	26.000	0.875	610	660	22	25003-7469	23-L	24.500	25.625	0.625	622	651	16
21242-4294	64-L	24.000	26.000	0.875	610	660	22	21333-2806	143	24.500	25.812	0.781	622	656	20
21773-4294	64-L	24.000	26.000	0.875	610	660	22	25003-9282	23-L	24.500	26.000	0.750	622	660	19
21222-4294	64-L	24.000	26.000	0.875	610	660	22	21432-1133	142-L	24.500	26.000	1.000	622	660	25
21226-4294	64-L	24.000	26.000	0.875	610	660	22	25003-6987	23-L	24.500	26.250	0.813	622	667	21
21238-4294	64-L	24.000	26.000	0.875	610	660	22	25003-8689	23-L	24.500	26.500	0.813	622	673	21
21852-4294	64-L	24.000	26.000	0.875	610	660	22	21247-4305	64-L	24.500	26.500	0.875	622	673	22
21243-4294	64-L	24.000	26.000	0.875	610	660	22	21238-4305	64-L	24.500	26.500	0.875	622	673	22
21238-6293	64-L	24.000	26.250	0.875	610	667	22	21216-4305	64-L	24.500	26.500	0.875	622	673	22
24715-0436	59	24.000	26.250	1.000	610	667	25	21243-4305	64-L	24.500	26.500	0.875	622	673	22
24717-0436	59	24.000	26.250	1.000	610	667	25	21852-4305	64-L	24.500	26.500	0.875	622	673	22
24700-0436	59	24.000	26.250	1.000	610	667	25	24600-2505	26-L	24.567	25.748	0.590	624	654	15
21238-4297	64-L	24.000	26.500	0.875	610	673	22	25003-0626	23-L	24.625	25.500	0.375	625	648	10
24610-0437	26-L	24.000	26.500	1.000	610	673	25	25003-6965	23-L	24.625	25.875	0.563	625	657	14
24700-0437	59	24.000	26.500	1.000	610	673	25	25003-2196	23-L	24.640	25.640	0.500	626	651	13
25003-7119	23-L	24.016	25.984	0.811	610	660	21	25003-9313	23-L	24.750	25.750	0.500	629	654	13
25003-1112	23-L	24.016	25.748	0.787	610	654	20	24702-9532	59	24.750	26.750	0.625	629	679	16
25003-5707	23-L	24.093	26.093	0.812	612	663	21	25045-7200	23-L	24.750	26.750	0.813	629	679	21
21432-7422	142-L	24.213	25.213	0.750	615	640	19	25003-7200	23-L	24.750	26.750	0.813	629	679	21
21432-4141	142-L	24.213	25.713	1.000	615	653	25	25006-7200	23-L	24.750	26.750	0.813	629	679	21
25006-8139	23-L	24.250	25.250	0.500	616	641	13	25003-5720	23-L	24.803	26.303	0.750	630	668	19
21432-4543	142-L	24.250	25.250	0.750	616	641	19	24702-6584	59	24.803	26.378	0.750	630	670	19
21432-9498	142-L	24.250	25.375	1.250	616	645	32	21247-1451	64-L	24.803	26.378	0.750	630	670	19
25003-5954	23-L	24.250	25.625	0.563	616	651	14	24780-4011	59	24.803	26.378	0.787	630	670	20
24702-5497	59	24.250	25.750	0.750	616	654	19	24781-4011	59	24.803	26.378	0.787	630	670	20
21432-6458	142-L	24.250	25.750	1.000	616	654	25	24700-1070	59	24.803	26.750	0.875	630	679	22
24700-4494	59	24.250	26.000	1.000	616	660	25	25003-4728	23-L	24.803	26.772	0.787	630	680	20
25003-7352	23-L	24.250	26.250	0.813	616	667	21	26082-2884	87-L	24.803	26.181	0.563	630	665	14
24702-0438	59	24.250	26.250	0.875	616	667	22	21238-1451	64-L	24.803	26.378	0.748	630	670	19

All dimensions are in inches. Preferred sizes are indicated with **bold** type face.

Sizes listed are for standard nitrile elements, except Models 25 and 62 which have PTFE elements. Other material available on inquiry only.

## Oil Seals by Model Number

Product Code	Model	Inches			MM			Product Code	Model	Inches			MM		
		ID	OD	Width	ID	OD	Width			ID	OD	Width	ID	OD	Width
21432-9393	142-L	24.875	26.375	1.000	632	670	25	25003-7646	23-L	25.438	27.188	0.750	646	691	19
25003-4839	23-L	24.875	26.875	0.813	632	683	21	25003-9988	23-L	25.500	26.500	0.500	648	673	13
24715-4814	59	24.921	26.671	0.803	633	677	20	25003-4317	23-L	25.500	27.000	0.750	648	686	19
25003-4422	23-L	25.000	25.904	0.500	635	658	13	24715-4207	59	25.500	27.000	0.875	648	686	22
25054-5798	23-L	25.000	26.000	0.500	635	660	13	21238-4300	64-L	25.500	27.000	0.875	648	686	22
25006-5798	23-L	25.000	26.000	0.500	635	660	13	21852-4300	64-L	25.500	27.000	0.875	648	686	22
21432-8566	142-L	25.000	26.125	1.375	635	664	35	21432-8547	142-L	25.500	27.000	1.000	648	686	25
25003-1098	23-L	25.000	26.250	0.625	635	667	16	25003-6918	23-L	25.500	27.500	0.750	648	699	19
25003-4308	23-L	25.000	26.500	0.750	635	673	19	24700-0454	59	25.500	27.500	0.750	648	699	19
25006-4308	23-L	25.000	26.500	0.750	635	673	19	25003-9090	23-L	25.500	27.500	0.813	648	699	21
24700-0443	59	25.000	26.500	0.750	635	673	19	24700-5162	59	25.500	27.500	0.875	648	699	22
24747-0443	59	25.000	26.500	0.750	635	673	19	21852-4318	64-L	25.500	27.500	0.875	648	699	22
21238-4308	64-L	25.000	26.500	0.750	635	673	19	21450-4318	64-L	25.500	27.500	0.875	648	699	22
21852-4308	64-L	25.000	26.500	0.750	635	673	19	21238-4318	64-L	25.500	27.500	0.875	648	699	22
21840-4308	64-L	25.000	26.500	0.750	635	673	19	26098-4318	87-L	25.500	27.500	0.875	648	699	22
26188-4308	88NS-L	25.000	26.500	0.750	635	673	19	26188-4318	88NS-L	25.500	27.500	0.875	648	699	22
22503-2698	64 G1-L	25.000	26.500	0.875	635	673	22	26088-4318	88-L	25.500	27.500	0.875	648	699	22
21432-9699	142-L	25.000	26.500	1.000	635	673	25	26090-4318	88-L	25.500	27.500	0.875	648	699	22
25045-1273	23-L	25.000	26.811	0.813	635	681	21	24602-0980	26-L	25.500	28.000	1.000	648	711	25
25003-2509	23-L	25.000	26.875	0.750	635	683	19	25003-5743	23-L	25.530	27.030	0.750	648	687	19
25003-9154	23-L	25.000	27.000	0.750	635	686	19	25003-5779	23-L	25.590	26.590	0.500	650	675	13
25045-4843	23-L	25.000	27.000	0.790	635	686	20	24700-1044	59	25.590	27.165	0.787	650	690	20
25205-6419	23-L	25.000	27.000	0.813	635	686	21	25010-2359	23-L	25.591	27.559	0.787	650	700	20
25003-6419	23-L	25.000	27.000	0.813	635	686	21	24715-4244	59	25.591	27.756	0.787	650	705	20
24627-3774	26-L	25.000	27.000	0.875	635	686	22	24700-4244	59	25.591	27.756	0.787	650	705	20
24700-0444	59	25.000	27.000	0.875	635	686	22	24751-4517	59 G1	25.591	27.953	0.984	650	710	25
21247-3774	64-L	25.000	27.000	0.875	635	686	22	24715-4517	59	25.591	27.953	0.984	650	710	25
21238-3774	64-L	25.000	27.000	0.875	635	686	22	24700-4517	59	25.591	27.953	0.984	650	710	25
21221-3774	64-L	25.000	27.000	0.875	635	686	22	25003-9382	23-L	25.625	26.625	0.500	651	676	13
21852-3774	64-L	25.000	27.000	0.875	635	686	22	25006-9382	23-L	25.625	26.625	0.500	651	676	13
26080-2207	87-L	25.000	27.000	0.906	635	686	23	25001-8773	21-L	25.625	26.750	0.500	651	679	13
21238-4309	64-L	25.000	27.000	1.000	635	686	25	25008-8773	21-L	25.625	26.750	0.500	651	679	13
21238-6421	64-L	25.000	27.250	0.875	635	692	22	25002-8773	21-L	25.625	26.750	0.500	651	679	13
24700-0445	59	25.000	27.375	0.875	635	695	22	25006-8773	23-L	25.625	26.750	0.500	651	679	13
26088-5997	88-L	25.000	27.500	0.875	635	699	22	25003-1997	23-L	25.625	26.875	0.625	651	683	16
24700-0821	59	25.000	27.500	1.000	635	699	25	25003-0663	23-L	25.625	27.625	0.813	651	702	21
25003-9982	23-L	25.006	26.006	0.375	635	661	10	25003-5141	23-L	25.750	26.750	0.500	654	679	13
25003-5729	23-L	25.125	26.125	0.500	638	664	13	25001-4676	21-L	25.750	26.875	0.500	654	683	13
21432-7681	142-L	25.125	26.250	1.250	638	667	32	25003-4676	23-L	25.750	26.875	0.500	654	683	13
21432-8390	142-L	25.125	26.250	1.375	638	667	35	24610-1770	26-L	25.750	26.875	0.500	654	683	13
21238-4311	64-L	25.188	26.875	0.750	640	683	19	25003-7899	23-L	25.750	26.875	0.547	654	683	14
21852-4311	64-L	25.188	26.875	0.750	640	683	19	25003-9025	23-L	25.750	26.875	0.563	654	683	14
21238-5994	64-L	25.188	26.938	0.750	640	684	19	25003-6321	23-L	25.750	26.875	0.625	654	683	16
25045-5828	23-L	25.188	27.188	0.813	640	691	21	25003-9305	23-L	25.750	26.875	0.750	654	683	19
25003-6823	23-L	25.196	26.696	0.750	640	678	19	25003-6539	23-L	25.750	27.000	0.500	654	686	13
25003-1719	23-L	25.197	27.165	0.807	640	690	21	25003-5894	23-L	25.750	27.000	0.625	654	686	16
24700-6590	59	25.250	27.250	0.750	641	692	19	25003-6998	23-L	25.750	27.250	0.750	654	692	19
25003-7859	23-L	25.250	27.250	0.813	641	692	21	24700-0456	59	25.750	27.250	0.750	654	692	19
24700-0450	59	25.250	27.250	0.875	641	692	22	21238-6998	64-L	25.750	27.250	0.750	654	692	19
21443-0863	142-L	25.375	26.500	1.250	645	673	32	25003-9569	23-L	25.750	27.750	0.813	654	705	21
25003-2709	23-L	25.375	26.875	0.562	645	683	14	25003-0671	23-L	25.750	28.125	0.750	654	714	19
24715-6091	59	25.375	27.375	0.750	645	695	19	25003-0696	23-L	25.875	26.750	0.375	657	679	10
25003-4363	23-L	25.375	27.375	0.812	645	695	21	25003-4698	23-L	25.875	26.875	0.500	657	683	13
24744-6522	59	25.375	28.500	0.906	645	724	23	25003-9266	23-L	25.875	27.875	0.813	657	708	21
24700-4360	59	25.437	27.188	0.750	646	691	19	24600-6177	26-L	25.984	28.504	0.984	660	724	25
25054-7646	23-L	25.438	27.188	0.750	646	691	19	21247-4306	64-L	25.988	27.625	0.750	660	702	19

All dimensions are in inches. Preferred sizes are indicated with **bold** type face.

Sizes listed are for standard nitrile elements, except Models 25 and 62 which have PTFE elements. Other material available on inquiry only.

## Oil Seals by Model Number

Product Code	Model	Inches			MM			Product Code	Model	Inches			MM		
		ID	OD	Width	ID	OD	Width			ID	OD	Width	ID	OD	Width
21238-4306	64-L	25.988	27.625	0.750	660	702	19	21432-2594	142-L	26.500	27.500	0.750	673	699	19
21852-4306	64-L	25.988	27.625	0.750	660	702	19	25003-4533	23-L	26.500	28.000	0.750	673	711	19
25003-4714	23-L	26.000	27.000	0.500	660	686	13	24627-0467	26-L	26.500	28.000	0.750	673	711	19
21432-9318	142-L	26.000	27.125	1.375	660	689	35	24610-0467	26-L	26.500	28.000	0.750	673	711	19
25003-0959	23-L	26.000	27.250	0.625	660	692	16	24715-0467	59	26.500	28.000	0.750	673	711	19
21334-3841	143	26.000	27.312	0.781	660	694	20	24700-0467	59	26.500	28.000	0.750	673	711	19
21432-9183	142-L	26.000	27.500	1.000	660	699	25	24707-0467	59	26.500	28.000	0.750	673	711	19
24700-0460	59	26.000	27.625	0.750	660	702	19	24742-0467	59	26.500	28.000	0.750	673	711	19
21238-5921	64-L	26.000	27.625	0.750	660	702	19	21852-4533	64-L	26.500	28.000	0.750	673	711	19
21852-5921	64-L	26.000	27.625	0.750	660	702	19	21247-4533	64-L	26.500	28.000	0.750	673	711	19
26188-5921	88NS-L	26.000	27.625	0.750	660	702	19	21773-4533	64-L	26.500	28.000	0.750	673	711	19
26088-5921	88-L	26.000	27.625	0.750	660	702	19	21221-4533	64-L	26.500	28.000	0.750	673	711	19
21247-5921	64-L	26.000	27.625	0.875	660	702	22	21238-4533	64-L	26.500	28.000	0.750	673	711	19
24751-5993	59G1	26.000	27.625	1.000	660	702	25	21243-4533	64-L	26.500	28.000	0.750	673	711	19
25003-7710	23-L	26.000	28.000	0.750	660	711	19	24707-3279	59	26.500	28.000	0.875	673	711	22
24715-0461	59	26.000	28.000	0.750	660	711	19	25003-6332	23-L	26.500	28.500	0.813	673	724	21
25006-6483	23-L	26.000	28.000	0.812	660	711	21	21247-4313	64-L	26.500	28.500	0.875	673	724	22
25010-6483	23-L	26.000	28.000	0.813	660	711	21	21238-4313	64-L	26.500	28.500	0.875	673	724	22
25003-6483	23-L	26.000	28.000	0.813	660	711	21	25003-2707	23-L	26.625	28.125	0.750	676	714	19
21247-4325	64-L	26.000	28.000	0.875	660	711	22	21340-3291	143	26.737	30.799	2.000	679	782	51
21238-4325	64-L	26.000	28.000	0.875	660	711	22	21333-2100	143	26.738	28.050	0.781	679	712	20
21221-4325	64-L	26.000	28.000	0.875	660	711	22	21432-2591	142-L	26.750	27.750	0.750	679	705	19
21852-4325	64-L	26.000	28.000	0.875	660	711	22	25003-2628	23-L	26.750	28.563	0.813	679	726	21
24610-0462	26-L	26.000	28.500	0.875	660	724	22	25045-9647	23-L	26.750	28.750	0.812	679	730	21
24736-0462	59	26.000	28.500	0.875	660	724	22	25003-9647	23-L	26.750	28.750	0.813	679	730	21
21238-4794	64-L	26.000	28.500	0.875	660	724	22	25003-5799	23-L	26.771	27.771	0.500	680	705	13
24751-5075	59G1	26.125	27.625	0.750	664	702	19	24700-6612	59	26.772	28.740	0.787	680	730	20
21247-4329	64-L	26.125	27.625	0.750	664	702	19	25003-5278	23-L	26.781	28.781	0.812	680	731	21
21238-4329	64-L	26.125	27.625	0.750	664	702	19	21333-4380	143	26.800	28.112	0.781	681	714	20
22504-3352	64G1-L	26.125	27.625	0.875	664	702	22	25003-6819	23-L	26.815	28.815	0.812	681	732	21
25003-7699	23-L	26.125	28.125	0.813	664	714	21	25003-1312	23-L	26.875	27.750	0.375	683	705	10
24715-0463	59	26.125	28.125	0.813	664	714	21	25003-0755	23-L	26.875	28.125	0.500	683	714	13
24715-0825	59	26.125	28.125	0.875	664	714	22	25003-5102	23-L	26.875	28.875	0.813	683	733	21
21247-4330	64-L	26.125	28.125	0.875	664	714	22	25003-1169	23-L	26.968	27.953	0.500	685	710	13
21255-4330	64-L	26.125	28.125	0.875	664	714	22	25003-8043	23-L	27.000	28.000	0.500	686	711	13
21238-4330	64-L	26.125	28.125	0.875	664	714	22	21432-2592	142-L	27.000	28.000	0.750	686	711	19
21854-4330	64-L	26.125	28.125	0.875	664	714	22	21432-8277	142-L	27.000	28.125	1.375	686	714	35
21243-4330	64-L	26.125	28.125	0.875	664	714	22	25003-5050	23-L	27.000	28.500	0.625	686	724	16
21852-4330	64-L	26.125	28.125	0.875	664	714	22	25010-5607	23-L	27.000	29.000	0.750	686	737	19
22503-3823	64G1-L	26.125	28.125	1.000	664	714	25	24702-0470	59	27.000	29.000	0.750	686	737	19
24717-3163	59	26.180	28.701	0.875	665	729	22	24700-0470	59	27.000	29.000	0.750	686	737	19
24602-2188	26-L	26.181	28.701	0.984	665	729	25	24707-0470	59	27.000	29.000	0.750	686	737	19
24612-2188	26-L	26.181	28.701	0.984	665	729	25	25003-7340	23-L	27.000	29.000	0.813	686	737	21
25003-3141	23-L	26.220	27.220	0.500	666	691	13	21247-4333	64-L	27.000	29.000	0.875	686	737	22
25003-9759	23-L	26.250	28.250	0.813	667	718	21	21238-4333	64-L	27.000	29.000	0.875	686	737	22
21432-7685	142-L	26.299	27.795	1.000	668	706	25	21852-4333	64-L	27.000	29.000	0.875	686	737	22
25003-3307	23-L	26.375	28.188	0.812	670	716	21	21243-4333	64-L	27.000	29.000	0.875	686	737	22
24700-4097	59	26.375	28.188	0.875	670	716	22	26088-4333	88-L	27.000	29.000	0.875	686	737	22
25003-5017	23-L	26.375	28.375	0.813	670	721	21	21086-3781	53-L	27.000	29.000	1.000	686	737	25
24700-0466	59	26.375	28.375	1.000	670	721	25	24700-1971	59	27.000	29.000	1.000	686	737	25
24700-3945	59	26.378	27.953	0.787	670	710	20	22505-3781	64G1-L	27.000	29.000	1.000	686	737	25
25003-2248	23-L	26.378	27.874	0.748	670	708	19	21238-8031	64-L	27.000	29.500	0.875	686	749	22
24707-3945	59	26.378	27.953	0.787	670	710	20	21222-8031	64-L	27.000	29.500	0.875	686	749	22
24700-0464	59	26.378	28.189	0.748	670	716	19	24612-3489	26-L	27.165	28.740	0.787	690	730	20
24700-4672	59	26.378	28.898	0.984	670	734	25	24700-3489	59	27.165	28.740	0.787	690	730	20
21432-2593	142-L	26.437	27.437	0.750	671	697	19	21432-9319	142-L	27.250	28.375	1.375	692	721	35

All dimensions are in inches. Preferred sizes are indicated with **bold** type face.

Sizes listed are for standard nitrile elements, except Models 25 and 62 which have PTFE elements. Other material available on inquiry only.

## Oil Seals by Model Number

Product Code	Model	Inches			MM			Product Code	Model	Inches			MM		
		ID	OD	Width	ID	OD	Width			ID	OD	Width	ID	OD	Width
25003-8103	23-L	27.250	29.250	0.813	692	743	21	24700-0482	59	28.000	29.813	0.750	711	757	19
24700-4626	59	27.250	29.250	0.875	692	743	22	21238-4316	64-L	28.000	29.813	0.750	711	757	19
21247-4626	64-L	27.250	29.250	0.875	692	743	22	25010-6786	23-L	28.000	30.000	0.812	711	762	21
21238-4626	64-L	27.250	29.250	0.875	692	743	22	25003-6786	23-L	28.000	30.000	0.813	711	762	21
25003-4315	23-L	27.500	29.000	0.750	699	737	19	24700-0483	59	28.000	30.000	0.875	711	762	22
21238-4315	64-L	27.500	29.000	0.750	699	737	19	24707-0483	59	28.000	30.000	0.875	711	762	22
25003-2313	23-L	27.500	29.500	0.750	699	749	19	24702-0483	59	28.000	30.000	0.875	711	762	22
25003-7251	23-L	27.500	29.500	0.813	699	749	21	21247-4344	64-L	28.000	30.000	0.875	711	762	22
24702-0475	59	27.500	29.500	0.875	699	749	22	21238-4344	64-L	28.000	30.000	0.875	711	762	22
24739-0475	59	27.500	29.500	0.875	699	749	22	21773-4344	64-L	28.000	30.000	0.875	711	762	22
24700-0475	59	27.500	29.500	0.875	699	749	22	21852-4344	64-L	28.000	30.000	0.875	711	762	22
24707-0475	59	27.500	29.500	0.875	699	749	22	21840-4344	64-L	28.000	30.000	0.875	711	762	22
24736-0475	59	27.500	29.500	0.875	699	749	22	21243-4344	64-L	28.000	30.000	0.875	711	762	22
21247-4339	64-L	27.500	29.500	0.875	699	749	22	21238-4320	64-L	28.000	30.250	0.813	711	768	21
21238-4339	64-L	27.500	29.500	0.875	699	749	22	24700-0485	59	28.000	30.500	0.875	711	775	22
21852-4339	64-L	27.500	29.500	0.875	699	749	22	21238-3878	64-L	28.000	30.500	0.875	711	775	22
26088-3784	88-L	27.500	29.500	1.000	699	749	25	26688-3878	88-L	28.000	30.500	0.875	711	775	22
26588-3784	88-L	27.500	29.500	1.000	699	749	25	26088-3878	88-L	28.000	30.500	0.875	711	775	22
25003-4187	23-L	27.559	29.528	0.787	700	750	20	24700-0820	59	28.000	30.500	1.000	711	775	25
25003-4481	23-L	27.559	29.055	0.748	700	738	19	26098-2208	87-L	28.000	30.500	1.000	711	775	25
24700-0476	59	27.625	29.125	0.750	702	740	19	25003-6068	23-L	28.125	29.250	0.500	714	743	13
21769-5001	64-L	27.625	29.625	0.750	702	752	19	25003-0896	23-L	28.250	29.500	0.625	718	749	16
21238-5001	64-L	27.625	29.625	0.750	702	752	19	21432-5272	142-L	28.250	29.750	1.000	718	756	25
25003-9420	23-L	27.750	28.875	0.563	705	733	14	25003-9575	23-L	28.250	30.250	0.813	718	768	21
25003-8190	23-L	27.750	29.750	0.813	705	756	21	25003-4394	23-L	28.250	30.250	1.250	718	768	32
24610-6096	26-L	27.843	29.843	0.875	707	758	22	25054-0786	23-L	28.346	30.315	0.984	720	770	25
24715-0478	59	27.875	29.812	0.875	708	757	22	25003-7900	23-L	28.375	29.500	0.500	721	749	13
21238-4341	64-L	27.875	29.813	0.875	708	757	22	25003-0458	23-L	28.486	29.860	0.688	724	758	17
21957-4341	64-L	27.875	29.813	0.875	708	757	22	25003-5266	23-L	28.500	29.500	0.500	724	749	13
24715-0479	59	27.875	29.815	0.875	708	757	22	24715-0490	59	28.500	30.500	0.625	724	775	16
24700-0479	59	27.875	29.815	0.875	708	757	22	24703-0490	59	28.500	30.500	0.625	724	775	16
25003-9690	23-L	27.875	29.875	0.813	708	759	21	24700-1997	59	28.500	30.500	0.750	724	775	19
25003-5860	23-L	27.952	29.952	0.812	710	761	21	25003-7655	23-L	28.500	30.500	0.813	724	775	21
24627-5923	26-L	27.953	29.921	0.787	710	760	20	25003-4346	23-L	28.500	30.500	0.875	724	775	22
24736-4239	59	27.953	30.472	0.866	710	774	22	24700-4454	59	28.500	30.500	0.875	724	775	22
24627-5302	26-L	27.953	30.472	0.984	710	774	25	24743-4454	59	28.500	30.500	0.875	724	775	22
24700-5920	59	27.953	29.921	0.787	710	760	20	21238-4346	64-L	28.500	30.500	0.875	724	775	22
24700-6536	59	27.953	30.433	0.866	710	773	22	21773-4346	64-L	28.500	30.500	0.875	724	775	22
24610-5302	26-L	27.953	30.473	0.984	710	774	25	21852-4346	64-L	28.500	30.500	0.875	724	775	22
25003-5895	23-L	27.969	29.969	0.813	710	761	21	26088-4346	88-L	28.500	30.500	0.875	724	775	22
25003-9890	23-L	27.992	29.119	0.500	711	740	13	26588-4346	88-L	28.500	30.500	0.875	724	775	22
25003-5504	23-L	28.000	29.125	0.500	711	740	13	25010-3821	23-L	28.500	31.000	0.750	724	787	19
21432-9832	142-L	28.000	29.125	1.250	711	740	32	21238-4534	64-L	28.500	31.000	0.875	724	787	22
21432-8561	142-L	28.000	29.125	1.375	711	740	35	24780-4026	59	28.543	30.512	0.984	725	775	25
25003-3366	23-L	28.000	29.250	0.625	711	743	16	25003-2158	23-L	28.625	30.625	0.813	727	778	21
25003-4343	23-L	28.000	29.500	0.750	711	749	19	24700-4516	59	28.740	31.102	0.984	730	790	25
24715-0480	59	28.000	29.500	0.750	711	749	19	24700-4487	59	28.740	31.259	1.007	730	794	26
24700-0480	59	28.000	29.500	0.750	711	749	19	25003-2796	23-L	28.740	31.260	0.748	730	794	19
21245-4343	64-L	28.000	29.500	0.750	711	749	19	24700-2543	59	28.740	31.260	0.984	730	794	25
21247-4343	64-L	28.000	29.500	0.750	711	749	19	25003-5863	23-L	28.750	29.750	0.500	730	756	13
21259-4343	64-L	28.000	29.500	0.750	711	749	19	25003-6803	23-L	28.750	30.750	0.813	730	781	21
21238-4343	64-L	28.000	29.500	0.750	711	749	19	24700-0492	59	28.750	30.750	0.875	730	781	22
21773-4343	64-L	28.000	29.500	0.750	711	749	19	21238-4628	64-L	28.750	30.750	0.875	730	781	22
21221-4343	64-L	28.000	29.500	0.750	711	749	19	25003-5612	23-L	28.875	29.750	0.500	733	756	13
21852-4343	64-L	28.000	29.500	0.750	711	749	19	25003-9797	23-L	28.875	30.875	0.813	733	784	21
21432-9730	142-L	28.000	29.500	1.000	711	749	25	24700-5442	59	28.937	30.512	0.787	735	775	20

All dimensions are in inches. Preferred sizes are indicated with **bold** type face.  
Sizes listed are for standard nitrile elements, except Models 25 and 62 which have PTFE elements. Other material available on inquiry only.

















## Oil Seals by Model Number

Product Code	Model	Inches			MM			Product Code	Model	Inches			MM		
		ID	OD	Width	ID	OD	Width			ID	OD	Width	ID	OD	Width
25010-4856	23-L	62.000	64.000	0.813	1575	1626	21	25003-8279	23-L	76.250	78.250	0.813	1937	1988	21
25003-4856	23-L	62.000	64.000	0.813	1575	1626	21	25003-6130	23-L	76.500	78.500	0.813	1943	1994	21
21247-4856	64-L	62.000	64.000	0.813	1575	1626	21	25003-5236	23-L	77.500	79.500	0.813	1969	2019	21
21238-4856	64-L	62.000	64.000	0.813	1575	1626	21	25003-5796	23-L	79.500	81.500	0.813	2019	2070	21
21852-4856	64-L	62.000	64.000	0.813	1575	1626	21	25003-6905	23-L	80.000	82.000	0.812	2032	2083	21
25003-9599	23-L	63.000	65.000	0.813	1600	1651	21	25003-5757	23-L	80.500	82.500	0.813	2045	2096	21
21238-8557	64-L	63.327	65.748	0.787	1609	1670	20	25003-7871	23-L	81.000	83.000	0.813	2057	2108	21
24700-6726	59	63.377	65.748	0.875	1610	1670	22	25003-4912	23-L	82.283	84.252	0.813	2090	2140	21
25003-7015	23-L	63.500	65.500	0.812	1613	1664	21	25003-8802	23-L	82.677	84.646	0.815	2100	2150	21
21432-9885	142-L	63.622	65.622	1.250	1616	1667	32	25003-5663	23-L	84.000	86.000	0.500	2134	2184	13
21432-9627	142-L	63.650	65.650	1.250	1617	1668	32	25003-5279	23-L	84.000	86.000	0.812	2134	2184	21
24700-6427	59	63.752	65.748	0.875	1619	1670	22	25003-5297	23-L	85.000	87.000	0.812	2159	2210	21
24700-3961	59	63.780	65.551	0.787	1620	1665	20	25003-7624	23-L	87.000	89.000	0.813	2210	2261	21
24700-3903	59	64.000	65.375	0.875	1626	1661	22	25003-4919	23-L	88.031	90.031	0.813	2236	2287	21
25003-8324	23-L	64.000	66.000	0.813	1626	1676	21	25003-9953	23-L	88.583	90.583	0.813	2250	2301	21
21238-4979	64-L	64.409	66.929	0.866	1636	1700	22	25003-9269	23-L	93.000	95.000	0.813	2362	2413	21
25003-5586	23-L	64.488	66.488	0.813	1638	1689	21	25003-7291	23-L	94.000	96.000	0.813	2388	2438	21
25003-9289	23-L	64.500	66.500	0.813	1638	1689	21	21443-9905	142-L	94.000	96.000	1.500	2388	2438	38
25003-4809	23-L	64.748	66.717	0.787	1645	1695	20	25003-7137	23-L	96.620	98.620	0.813	2454	2505	21
25003-6915	23-L	65.000	67.000	0.812	1651	1702	21	25003-7334	23-L	98.750	100.750	0.813	2508	2559	21
25003-9344	23-L	65.250	67.250	0.813	1657	1708	21	25003-5788	23-L	102.000	104.000	0.812	2591	2642	21
25003-9806	23-L	65.354	67.354	0.813	1660	1711	21	25003-9902	23-L	108.000	110.000	0.813	2743	2794	21
25003-8563	23-L	66.000	68.000	0.813	1676	1727	21	21443-3116	142-L	115.500	117.000	1.000	2934	2972	25
25003-5811	23-L	66.500	68.000	0.750	1689	1727	19	25054-4466	23-L	130.265	131.890	1.000	3309	3350	25
25003-8618	23-L	66.500	68.500	0.813	1689	1740	21	25054-4464	23-L	133.406	135.030	1.000	3389	3430	25
25045-8872	23-L	66.500	69.000	0.813	1689	1753	21	25010-1598	23-L	149.842	151.810	0.787	3806	3856	20
25003-1091	23-L	66.875	68.000	0.563	1699	1727	14	25017-3631	23-L	169.760	171.260	0.750	4312	4350	19
25003-8750	23-L	67.000	69.000	0.813	1702	1753	21	25010-3627	23-L	174.700	176.200	0.750	4437	4475	19
21432-5422	142-L	67.750	69.750	1.250	1721	1772	32								
25003-9290	23-L	68.000	70.000	0.750	1727	1778	19								
25003-8748	23-L	68.000	70.000	0.812	1727	1778	21								
25003-2205	23-L	68.000	70.000	1.000	1727	1778	25								
25003-9800	23-L	68.500	70.500	0.813	1740	1791	21								
25003-9897	23-L	68.968	70.957	0.787	1752	1802	20								
25003-4811	23-L	68.988	70.957	0.787	1752	1802	20								
25003-7643	23-L	69.000	71.000	0.813	1753	1803	21								
25003-5533	23-L	69.375	71.375	0.813	1762	1813	21								
25003-9920	23-L	70.000	71.000	0.500	1778	1803	13								
25006-6424	23-L	70.000	72.000	0.812	1778	1829	21								
25045-6424	23-L	70.000	72.000	0.813	1778	1829	21								
25003-6424	23-L	70.000	72.000	0.813	1778	1829	21								
24700-3573	59	70.000	72.000	0.875	1778	1829	22								
25003-4658	23-L	70.688	72.688	0.875	1795	1846	22								
25003-2144	23-L	72.500	74.000	0.750	1842	1880	19								
25003-6276	23-L	73.000	75.000	0.812	1854	1905	21								
25003-8865	23-L	74.000	76.000	0.812	1880	1930	21								
21238-9010	64-L	74.409	76.929	0.984	1890	1954	25								
25003-5624	23-L	74.500	76.000	0.750	1892	1930	19								
25003-0952	23-L	74.500	76.500	0.812	1892	1943	21								
25003-4702	23-L	75.000	76.000	0.375	1905	1930	10								
25003-1697	23-L	75.000	76.500	0.750	1905	1943	19								
25003-9869	23-L	75.000	77.000	0.813	1905	1956	21								
25003-3147	23-L	75.000	77.000	1.000	1905	1956	25								
25003-0720	23-L	75.188	77.188	0.813	1910	1961	21								
21432-5529	142-L	75.750	77.750	1.250	1924	1975	32								
25003-7583	23-L	76.000	78.000	0.813	1930	1981	21								

All dimensions are in inches. Preferred sizes are indicated with **bold** type face.

Sizes listed are for standard nitrile elements, except Models 25 and 62 which have PTFE elements. Other material available on inquiry only.



## Face Seals by Model Number

Product Code	Model	Inches		MM		Product Code	Model	Inches		MM	
		From ID	To ID	From ID	To ID			From ID	To ID	From ID	To ID
21750-0160	145A2	6.100	6.500	155	165	21700-0500	145A1	19.690	19.880	500	505
21748-0170	145L	6.500	6.890	165	175	21700-0505	145A1	19.880	20.080	505	510
21750-0180	145A2	6.890	7.200	175	183	21700-0510	145A1	20.080	20.280	510	515
21754-0180	145A2	6.890	7.290	175	185	21700-0515	145A1	20.280	20.470	515	520
21751-0180	145A2	6.890	7.290	175	185	21700-0520	145A1	20.470	20.670	520	525
21754-0200	145A2	7.480	8.270	190	210	21700-0525	145A1	20.670	20.870	525	530
21750-0200	145A2	7.480	8.270	190	210	21700-0530	145A1	20.870	21.060	530	535
21751-0200	145A2	7.480	8.270	190	210	21754-0550	145A2	20.870	22.830	530	580
21750-0220	145A2	8.270	9.250	210	235	21750-0550	145A2	20.870	22.830	530	580
21751-0220	145A2	8.270	9.250	210	235	21700-0540	145A1	21.260	21.460	540	545
21754-0250	145A2	9.250	10.430	235	265	21700-0545	145A1	21.460	21.650	545	550
21750-0250	145A2	9.250	10.430	235	265	21700-0550	145A1	21.650	21.850	550	555
21751-0250	145A2	9.250	10.430	235	265	21700-0555	145A1	21.850	22.440	555	570
21748-0275	145L	10.240	11.220	260	285	21700-0560	145A1	22.050	22.240	560	565
21750-0275	145A2	10.430	11.420	265	290	21722-0560	145A1	22.050	22.240	560	565
21751-0275	145A2	10.430	11.420	265	290	21700-0570	145A1	22.440	22.640	570	575
21748-0300	145L	11.200	12.200	284	310	21700-0575	145A1	22.640	22.840	575	580
21750-0300	145A2	11.420	12.200	290	310	21712-0600	145A1	22.830	24.800	580	630
21751-0300	145A2	11.420	12.200	290	310	21750-0600	145A2	22.830	24.800	580	630
21750-0325	145A2	12.200	13.190	310	335	21751-0600	145A2	22.830	24.800	580	630
21748-0325	145L	12.200	13.190	310	335	21700-0580	145A1	22.840	23.030	580	585
21700-0350	145A1	12.953	13.130	329	334	21700-0585	145A1	23.030	23.230	585	590
21750-0350	145A2	13.190	14.370	335	365	21700-0600	145A1	23.260	24.020	591	610
21748-0350	145L	13.190	14.370	335	365	21700-0610	145A1	24.020	24.410	610	620
21700-0360	145A1	14.170	14.300	360	363	21700-0620	145A1	24.410	24.800	620	630
21748-0375	145L	14.370	15.190	365	386	21700-0630	145A1	24.800	25.200	630	640
21754-0375	145A2	14.370	15.350	365	390	21754-0650	145A2	24.800	26.180	630	665
21750-0375	145A2	14.370	15.350	365	390	21750-0650	145A2	24.800	26.180	630	665
21700-0390	145A1	15.350	15.500	390	394	21751-0650	145A2	24.800	26.180	630	665
21712-0390	145A1	15.350	15.550	390	395	21700-0650	145A1	25.580	25.980	650	660
21754-0400	145A2	15.350	16.930	390	430	21722-0650	145A1	25.590	25.980	650	660
21750-0400	145A2	15.350	16.930	390	430	21700-0660	145A1	25.980	26.380	660	670
21751-0400	145A2	15.350	16.930	390	430	21750-0700	145A2	26.180	27.760	665	705
21700-0425	145A1	15.866	16.056	403	408	21751-0700	145A2	26.180	27.760	665	705
21700-0410	145A1	16.000	16.142	406	410	21700-0670	145A1	26.380	26.770	670	680
21700-0400	145A1	16.000	16.200	406	411	21700-0680	145A1	26.770	27.170	680	690
21748-0450	145L	16.730	18.700	425	475	21700-0690	145A1	27.170	27.560	690	700
21700-0430	145A1	16.900	17.100	429	434	21722-0690	145A1	27.170	27.560	690	700
21754-0450	145A2	16.930	18.900	430	480	21700-0700	145A1	27.560	27.950	700	710
21750-0450	145A2	16.930	18.900	430	480	21754-0725	145A2	27.760	29.330	705	745
21751-0450	145A2	16.930	18.900	430	480	21750-0725	145A2	27.760	29.330	705	745
21700-0435	145A1	17.000	17.125	432	435	21751-0725	145A2	27.760	29.330	705	745
21700-0445	145A1	17.520	17.710	445	450	21700-0730	145A1	28.740	29.130	730	740
21700-0450	145A1	17.720	17.910	450	455	21722-0730	145A1	28.740	29.130	730	740
21700-0455	145A1	17.910	18.110	455	460	21700-0740	145A1	29.130	29.530	740	750
21750-0475	145A2	17.920	19.890	455	505	21750-0750	145A2	29.330	30.910	745	785
21700-0460	145A1	18.110	18.310	460	465	21700-0750	145A1	29.530	29.840	750	758
21700-0465	145A1	18.310	18.500	465	470	21700-0760	145A1	29.840	30.160	758	766
21700-0470	145A1	18.500	18.700	470	475	21700-0770	145A1	30.160	30.470	766	774
21700-0475	145A1	18.700	18.900	475	480	21700-0790	145A1	30.830	31.180	783	792
21700-0480	145A1	18.900	19.090	480	485	21722-0790	145A1	30.830	31.180	783	792
21754-0500	145A2	18.900	20.870	480	530	21754-0800	145A2	30.910	32.680	785	830
21750-0500	145A2	18.900	20.870	480	530	21750-0800	145A2	30.910	32.680	785	830
21751-0500	145A2	18.900	20.870	480	530	21751-0800	145A2	30.910	32.680	785	830
21700-0485	145A1	19.090	19.290	485	490	21700-0800	145A1	31.180	31.540	792	801
21700-0495	145A1	19.490	19.690	495	500						

All dimensions are in inches. Preferred sizes are indicated with **bold** type face.  
 Sizes listed are for standard nitrile elements, except Models 25 and 62 which have PTFE elements. Other material available on inquiry only.

## Face Seals by Model Number

Product Code	Model	Inches		MM		Product Code	Model	Inches		MM	
		ID	OD Width	ID	OD Width			ID	OD Width	ID	OD Width
21712-0810	145A1	31.540	31.890	801	810	21700-1850	145A1	71.260	73.030	1810	1855
21700-0820	145A1	31.890	32.320	810	821	21712-1900	145A1	73.030	75.000	1855	1905
21700-0830	145A1	32.320	32.720	821	831	21700-1900	145A1	73.030	75.000	1855	1905
21750-0850	145A2	32.680	34.450	830	875	21750-1950	145A2	75.590	77.560	1920	1970
21712-0840	145A1	32.700	33.110	831	841	21700-2000	145A1	76.970	79.130	1955	2010
21700-0840	145A1	32.720	33.110	831	841	21700-2200	145A1	85.010	87.000	2159	2210
21712-0850	145A1	33.110	33.500	841	851	21700-2250	145A1	87.010	89.000	2210	2261
21700-0880	145A1	34.290	34.720	871	882	21750-2250	145A2	87.500	89.500	2223	2273
21750-0900	145A2	34.450	36.220	875	920	21700-2650	145A1	103.010	105.000	2616	2667
21700-0890	145A1	34.720	35.120	882	892	21700-3200	145A1	125.010	127.000	3175	3226
21700-0900	145A1	35.120	35.910	892	912	21700-3250	145A1	127.010	129.000	3226	3277
21750-0950	145A2	36.220	37.990	920	965	21700-3300	145A1	129.010	131.000	3277	3327
21751-0950	145A2	36.220	37.990	920	965	21700-4350	145A1	171.000	173.000	4343	4394
21700-0930	145A1	36.300	36.730	922	933						
21700-0940	145A1	36.730	37.170	933	944						
21700-0950	145A1	37.170	37.600	944	955						
21750-1000	145A2	37.990	39.960	965	1015						
21700-0980	145A1	38.470	38.900	977	988						
21700-0990	145A1	38.900	39.330	988	999						
21700-1000	145A1	39.330	39.760	999	1010						
21700-1020	145A1	39.760	40.350	1010	1025						
21750-1050	145A2	39.960	41.930	1015	1065						
21700-1040	145A1	40.350	41.140	1025	1045						
21700-1060	145A1	41.140	41.930	1045	1065						
21700-1080	145A1	41.930	42.720	1065	1085						
21750-1100	145A2	41.930	43.900	1065	1115						
21700-1100	145A1	42.720	43.500	1085	1105						
21700-1120	145A1	43.500	44.290	1105	1125						
21754-1150	145A2	43.900	45.870	1115	1165						
21750-1150	145A2	43.900	45.870	1115	1165						
21700-1160	145A1	45.080	45.870	1145	1165						
21700-1180	145A1	45.870	46.650	1165	1185						
21750-1200	145A2	45.870	47.840	1165	1215						
21700-1200	145A1	46.650	47.440	1185	1205						
21700-1220	145A1	47.440	48.230	1205	1225						
21754-1250	145A2	47.840	50.000	1215	1270						
21750-1250	145A2	47.840	50.000	1215	1270						
21751-1250	145A2	47.840	50.000	1215	1270						
21700-1240	145A1	48.230	49.020	1225	1245						
21700-1260	145A1	49.020	50.000	1245	1270						
21700-1280	145A1	50.000	50.980	1270	1295						
21750-1300	145A2	50.000	51.970	1270	1320						
21700-1300	145A1	50.980	51.770	1295	1315						
21700-1325	145A1	51.770	52.760	1315	1340						
21750-1350	145A2	51.970	53.940	1320	1370						
21700-1350	145A1	52.760	53.740	1340	1365						
21750-1400	145A2	53.940	55.910	1370	1420						
21700-1425	145A1	55.710	56.690	1415	1440						
21750-1450	145A2	55.910	57.870	1420	1470						
21700-1525	145A1	59.650	60.630	1515	1540						
21750-1550	145A2	59.840	61.810	1520	1570						
21712-1575	145A1	61.810	62.990	1570	1600						
21700-1575	145A1	61.810	62.990	1570	1600						
21700-1750	145A1	67.720	69.409	1720	1763						
21750-1750	145A2	67.720	69.690	1720	1770						
21700-1800	145A1	69.490	71.260	1765	1810						

All dimensions are in inches. Preferred sizes are indicated with **bold** type face.

Sizes listed are for standard nitrile elements, except Models 25 and 62 which have PTFE elements. Other material available on inquiry only.



Алматы (7273)495-231  
Ангарск (3955)60-70-56  
Архангельск (8182)63-90-72  
Астрахань (8512)99-46-04  
Барнаул (3852)73-04-60  
Белгород (4722)40-23-64  
Благовещенск (4162)22-76-07  
Брянск (4832)59-03-52  
Владивосток (423)249-28-31  
Владикавказ (8672)28-90-48  
Владимир (4922)49-43-18  
Волгоград (844)278-03-48  
Вологда (8172)26-41-59  
Воронеж (473)204-51-73  
Екатеринбург (343)384-55-89

Иваново (4932)77-34-06  
Ижевск (3412)26-03-58  
Иркутск (395)279-98-46  
Казань (843)206-01-48  
Калининград (4012)72-03-81  
Калуга (4842)92-23-67  
Кемерово (3842)65-04-62  
Киров (8332)68-02-04  
Коломна (4966)23-41-49  
Кострома (4942)77-07-48  
Краснодар (861)203-40-90  
Красноярск (391)204-63-61  
Курск (4712)77-13-04  
Курган (3522)50-90-47  
Липецк (4742)52-20-81

Магнитогорск (3519)55-03-13  
Москва (495)268-04-70  
Мурманск (8152)59-64-93  
Набережные Челны (8552)20-53-41  
Нижний Новгород (831)429-08-12  
Новокузнецк (3843)20-46-81  
Новый Уренгой (3496)41-32-12  
Новосибирск (383)227-86-73  
Омск (3812)21-46-40  
Орел (4862)44-53-42  
Оренбург (3532)37-68-04  
Пенза (8412)22-31-16  
Петрозаводск (8142)55-98-37  
Псков (8112)59-10-37  
Пермь (342)205-81-47

Ростов-на-Дону (863)308-18-15  
Рязань (4912)46-61-64  
Самара (846)206-03-16  
Санкт-Петербург (812)309-46-40  
Саратов (845)249-38-78  
Севастополь (8692)22-31-93  
Саранск (8342)22-96-24  
Симферополь (3652)67-13-56  
Смоленск (4812)29-41-54  
Сочи (862)225-72-31  
Ставрополь (8652)20-65-13  
Сургут (3462)77-98-35  
Сыктывкар (8212)25-95-17  
Тамбов (4752)50-40-97  
Тверь (4822)63-31-35

Тольятти (8482)63-91-07  
Томск (3822)98-41-53  
Тула (4872)33-79-87  
Тюмень (3452)66-21-18  
Ульяновск (8422)24-23-59  
Улан-Удэ (3012)59-97-51  
Уфа (347)229-48-12  
Хабаровск (4212)92-98-04  
Чебоксары (8352)28-53-07  
Челябинск (351)202-03-61  
Череповец (8202)49-02-64  
Чита (3022)38-34-83  
Якутск (4112)23-90-97  
Ярославль (4852)69-52-93

Россия +7(495)268-04-70

Казахстан +7(7172)727-132

Киргизия +996(312)96-26-47

<https://timken.nt-rt.ru/> || [tek@nt-rt.ru](mailto:tek@nt-rt.ru)